

**The OSGi Alliance  
OSGi Compendium**

**Release 6  
July 2015**



**OSGi<sup>TM</sup>  
Alliance**

---

**Copyright © OSGi Alliance (2000, 2015).  
All Rights Reserved.**

## **OSGi Specification License, Version 2.0**

### **License Grant**

OSGi Alliance ("OSGi") hereby grants you a fully-paid, non-exclusive, non-transferable, worldwide, limited license (without the right to sublicense), under OSGi's applicable intellectual property rights to view, download, and reproduce this OSGi Specification ("Specification") which follows this License Agreement ("Agreement"). You are not authorized to create any derivative work of the Specification. However, to the extent that an implementation of the Specification would necessarily be a derivative work of the Specification, OSGi also grants you a perpetual, non-exclusive, worldwide, fully paid-up, royalty free, limited license (without the right to sublicense) under any applicable copyrights, to create and/or distribute an implementation of the Specification that: (i) fully implements the Specification including all its required interfaces and functionality; (ii) does not modify, subset, superset or otherwise extend the OSGi Name Space, or include any public or protected packages, classes, Java interfaces, fields or methods within the OSGi Name Space other than those required and authorized by the Specification. An implementation that does not satisfy limitations (i)-(ii) is not considered an implementation of the Specification, does not receive the benefits of this license, and must not be described as an implementation of the Specification. An implementation of the Specification must not claim to be a compliant implementation of the Specification unless it passes the OSGi Compliance Tests for the Specification in accordance with OSGi processes. "OSGi Name Space" shall mean the public class or interface declarations whose names begin with "org.osgi" or any recognized successors or replacements thereof.

OSGi Participants (as such term is defined in the OSGi Intellectual Property Rights Policy) have made non-assert and licensing commitments regarding patent claims necessary to implement the Specification, if any, under the OSGi Intellectual Property Rights Policy which is available for examination on the OSGi public web site ([www.osgi.org](http://www.osgi.org)).

### **No Warranties and Limitation of Liability**

THE SPECIFICATION IS PROVIDED "AS IS," AND OSGi AND ANY OTHER AUTHORS MAKE NO REPRESENTATIONS OR WARRANTIES, EXPRESS OR IMPLIED, INCLUDING, BUT NOT LIMITED TO, WARRANTIES OF MERCHANTABILITY, FITNESS FOR A PARTICULAR PURPOSE, NON-INFRINGEMENT, OR TITLE; THAT THE CONTENTS OF THE SPECIFICATION ARE SUITABLE FOR ANY PURPOSE; NOR THAT THE IMPLEMENTATION OF SUCH CONTENTS WILL NOT INFRINGE ANY THIRD PARTY PATENTS, COPYRIGHTS, TRADEMARKS OR OTHER RIGHTS. OSGi AND ANY OTHER AUTHORS WILL NOT BE LIABLE FOR ANY DIRECT, INDIRECT, SPECIAL, INCIDENTAL OR CONSEQUENTIAL DAMAGES ARISING OUT OF ANY USE OF THE SPECIFICATION OR THE PERFORMANCE OR IMPLEMENTATION OF THE CONTENTS THEREOF.

### **Covenant Not to Assert**

As a material condition to this license you hereby agree, to the extent that you have any patent claims which are necessarily infringed by an implementation of the Specification, not to assert any such patent claims against the creation, distribution or use of an implementation of the Specification.

### **General**

The name and trademarks of OSGi or any other Authors may NOT be used in any manner, including advertising or publicity pertaining to the Specification or its contents without specific, written prior permission. Title to copyright in the Specification will at all times remain with OSGi.

No other rights are granted by implication, estoppel or otherwise.

### **Trademarks**

OSGi™ is a trademark, registered trademark, or service mark of the OSGi Alliance in the US and other countries. Java is a trademark, registered trademark, or service mark of Oracle Corporation in the US and other countries. All other trademarks, registered trademarks, or service marks used in this document are the property of their respective owners and are hereby recognized.

### **Feedback**

This specification can be downloaded from the OSGi Alliance web site:

<http://www.osgi.org>

Comments about this specification can be raised at:

<https://osgi.org/bugzilla/>

---

---

# Table of Contents

<b>1</b>	<b>Introduction</b>	<b>17</b>
1.1	Reader Level.....	17
1.2	Version Information.....	17
1.3	References.....	19
1.4	Changes.....	19
<b>100</b>	<b>Remote Services</b>	<b>21</b>
100.1	The Fallacies.....	21
100.2	Remote Service Properties.....	22
100.3	Intents.....	26
100.4	General Usage.....	26
100.5	Configuration Types.....	27
100.6	Security.....	30
100.7	References.....	31
<b>101</b>	<b>Log Service Specification</b>	<b>33</b>
101.1	Introduction.....	33
101.2	The Log Service Interface.....	34
101.3	Log Level and Error Severity.....	35
101.4	Log Reader Service.....	35
101.5	Log Entry Interface.....	36
101.6	Mapping of Events.....	36
101.7	Security.....	39
101.8	org.osgi.service.log.....	39
<b>102</b>	<b>Http Service Specification</b>	<b>45</b>
102.1	Introduction.....	45
102.2	Registering Servlets.....	46
102.3	Registering Resources.....	48
102.4	Mapping HTTP Requests to Servlet and Resource Registrations.....	49
102.5	The Default Http Context Object.....	50
102.6	Multipurpose Internet Mail Extension (MIME) Types.....	51
102.7	Authentication.....	52
102.8	Security.....	53
102.9	Configuration Properties.....	54
102.10	org.osgi.service.http.....	54
102.11	References.....	59
<b>103</b>	<b>Device Access Specification</b>	<b>61</b>
103.1	Introduction.....	61
103.2	Device Services.....	63

103.3	Device Category Specifications.....	65
103.4	Driver Services.....	67
103.5	Driver Locator Service.....	73
103.6	The Driver Selector Service.....	76
103.7	Device Manager.....	76
103.8	Security.....	81
103.9	org.osgi.service.device.....	82
103.10	References.....	86
<b>104</b>	<b>Configuration Admin Service Specification</b>	<b>87</b>
104.1	Introduction.....	87
104.2	Configuration Targets.....	89
104.3	The Persistent Identity.....	90
104.4	The Configuration Object.....	93
104.5	Managed Service.....	96
104.6	Managed Service Factory.....	99
104.7	Configuration Admin Service.....	103
104.8	Configuration Events.....	107
104.9	Configuration Plugin.....	108
104.10	Meta Typing.....	110
104.11	Security.....	111
104.12	org.osgi.service.cm.....	112
104.13	Changes.....	129
<b>105</b>	<b>Metatype Service Specification</b>	<b>131</b>
105.1	Introduction.....	131
105.2	Attributes Model.....	132
105.3	Object Class Definition.....	133
105.4	Attribute Definition.....	133
105.5	Meta Type Service.....	134
105.6	Meta Type Provider Service.....	136
105.7	Using the Meta Type Resources.....	136
105.8	Meta Type Resource XML Schema.....	142
105.9	Meta Type Annotations.....	145
105.10	Limitations.....	147
105.11	Related Standards.....	147
105.12	Capabilities.....	147
105.13	Security Considerations.....	148
105.14	org.osgi.service.metatype.....	148
105.15	org.osgi.service.metatype.annotations.....	154
105.16	References.....	161
105.17	Changes.....	161
<b>106</b>	<b>PreferencesService Specification</b>	<b>163</b>



106.1	Introduction.....	163
106.2	Preferences Interface.....	165
106.3	Concurrency.....	167
106.4	PreferencesService Interface.....	168
106.5	Cleanup.....	168
106.6	org.osgi.service.prefs.....	168
106.7	References.....	178
<b>107</b>	<b>User Admin Service Specification</b>	<b>179</b>
107.1	Introduction.....	179
107.2	Authentication.....	181
107.3	Authorization.....	183
107.4	Repository Maintenance.....	185
107.5	User Admin Events.....	185
107.6	Security.....	186
107.7	Relation to JAAS.....	187
107.8	org.osgi.service.useradmin.....	187
107.9	References.....	198
<b>108</b>	<b>Wire Admin Service Specification</b>	<b>199</b>
108.1	Introduction.....	199
108.2	Producer Service.....	202
108.3	Consumer Service.....	204
108.4	Implementation issues.....	206
108.5	Wire Properties.....	206
108.6	Composite objects.....	208
108.7	Wire Flow Control.....	211
108.8	Flavors.....	214
108.9	Converters.....	214
108.10	Wire Admin Service Implementation.....	215
108.11	Wire Admin Listener Service Events.....	215
108.12	Connecting External Entities.....	217
108.13	Related Standards.....	218
108.14	Security.....	218
108.15	org.osgi.service.wireadmin.....	219
108.16	References.....	234
<b>109</b>	<b>IO Connector Service Specification</b>	<b>235</b>
109.1	Introduction.....	235
109.2	The Connector Framework.....	236
109.3	Connector Service.....	238
109.4	Providing New Schemes.....	238
109.5	Execution Environment.....	239
109.6	Security.....	240

109.7	org.osgi.service.io .....	240
109.8	References .....	243
<b>110</b>	<b>Initial Provisioning Specification</b>	<b>245</b>
110.1	Introduction .....	245
110.2	Procedure .....	246
110.3	Special Configurations .....	249
110.4	The Provisioning Service .....	250
110.5	Management Agent Environment .....	250
110.6	Mapping To File Scheme .....	251
110.7	Mapping To HTTP(S) Scheme .....	251
110.8	Mapping To RSH Scheme .....	253
110.9	Exception Handling .....	257
110.10	Security .....	257
110.11	org.osgi.service.provisioning .....	258
110.12	References .....	261
<b>111</b>	<b>UPnP™ Device Service Specification</b>	<b>263</b>
111.1	Introduction .....	263
111.2	UPnP Specifications .....	265
111.3	UPnP Device .....	266
111.4	Device Category .....	267
111.5	UPnPService .....	268
111.6	Working With a UPnP Device .....	268
111.7	Implementing a UPnP Device .....	269
111.8	Event API .....	269
111.9	UPnP Events and Event Admin service .....	270
111.10	Localization .....	271
111.11	Dates and Times .....	271
111.12	UPnP Exception .....	271
111.13	Configuration .....	272
111.14	Networking considerations .....	272
111.15	Security .....	272
111.16	org.osgi.service.upnp .....	272
111.17	References .....	287
<b>112</b>	<b>Declarative Services Specification</b>	<b>289</b>
112.1	Introduction .....	289
112.2	Components .....	292
112.3	References to Services .....	295
112.4	Component Description .....	305
112.5	Component Life Cycle .....	314
112.6	Component Properties .....	324
112.7	Deployment .....	325

112.8	Annotations.....	328
112.9	Service Component Runtime.....	333
112.10	Security.....	337
112.11	Component Description Schema.....	338
112.12	org.osgi.service.component.....	341
112.13	org.osgi.service.component.annotations.....	348
112.14	org.osgi.service.component.runtime.....	357
112.15	org.osgi.service.component.runtime.dto.....	359
112.16	References.....	365
112.17	Changes.....	365
<b>113</b>	<b>Event Admin Service Specification</b>	<b>367</b>
113.1	Introduction.....	367
113.2	Event Admin Architecture.....	368
113.3	The Event.....	369
113.4	Event Handler.....	370
113.5	Event Publisher.....	371
113.6	Specific Events.....	373
113.7	Event Admin Service.....	375
113.8	Reliability.....	377
113.9	Inter-operability with Native Applications.....	377
113.10	Security.....	377
113.11	org.osgi.service.event.....	378
<b>114</b>	<b>Deployment Admin Specification</b>	<b>389</b>
114.1	Introduction.....	389
114.2	Deployment Package.....	391
114.3	File Format.....	393
114.4	Fix Package.....	400
114.5	Customizer.....	401
114.6	Deployment Admin Service.....	402
114.7	Sessions.....	404
114.8	Installing a Deployment Package.....	406
114.9	Uninstalling a Deployment Package.....	411
114.10	Resource Processors.....	412
114.11	Events.....	417
114.12	Threading.....	417
114.13	Security.....	417
114.14	org.osgi.service.deploymentadmin.....	419
114.15	org.osgi.service.deploymentadmin.spi.....	431
114.16	References.....	437
<b>115</b>	<b>Auto Configuration Specification</b>	<b>439</b>
115.1	Introduction.....	439

115.2	Configuration Data.....	440
115.3	Processing.....	441
115.4	Security Considerations.....	444
<b>116</b>	<b>Application Admin Specification</b>	<b>447</b>
116.1	Introduction.....	447
116.2	Application Managers.....	448
116.3	Application Containers.....	454
116.4	Application Admin Implementations.....	460
116.5	Interaction.....	462
116.6	Security.....	464
116.7	org.osgi.service.application.....	465
116.8	References.....	476
<b>117</b>	<b>Dmt Admin Service Specification</b>	<b>477</b>
117.1	Introduction.....	477
117.2	The Device Management Model.....	480
117.3	The DMT Admin Service.....	483
117.4	Manipulating the DMT.....	483
117.5	Meta Data.....	491
117.6	Plugins.....	494
117.7	Sharing the DMT.....	500
117.8	Access Control Lists.....	507
117.9	Notifications.....	511
117.10	Exceptions.....	513
117.11	Events.....	513
117.12	OSGi Object Modeling.....	519
117.13	Security.....	527
117.14	org.osgi.service.dmt.....	531
117.15	org.osgi.service.dmt.spi.....	579
117.16	org.osgi.service.dmt.notification.....	593
117.17	org.osgi.service.dmt.notification.spi.....	596
117.18	org.osgi.service.dmt.security.....	597
117.19	References.....	602
<b>119</b>	<b>Monitor Admin Service Specification</b>	<b>603</b>
119.1	Introduction.....	603
119.2	Monitorable.....	604
119.3	Status Variable.....	606
119.4	Using Monitor Admin Service.....	607
119.5	Monitoring events.....	611
119.6	Security.....	611
119.7	org.osgi.service.monitor.....	612
119.8	References.....	624

<b>120</b>	<b>Foreign Application Access Specification</b>	<b>625</b>
120.1	Introduction.....	625
120.2	Foreign Applications.....	626
120.3	Application Containers.....	631
120.4	Application Descriptor Resource.....	632
120.5	Component Description Schema.....	633
120.6	Security.....	635
120.7	org.osgi.application.....	635
120.8	References.....	641
<b>121</b>	<b>Blueprint Container Specification</b>	<b>643</b>
121.1	Introduction.....	643
121.2	Managers.....	646
121.3	Blueprint Life-Cycle.....	653
121.4	Blueprint Definitions.....	659
121.5	Bean Manager.....	664
121.6	Service Manager.....	670
121.7	Service Reference Managers.....	676
121.8	Object Values.....	683
121.9	Dependency Injection.....	689
121.10	Service Dynamics.....	696
121.11	Blueprint Container.....	698
121.12	Events.....	699
121.13	Class Loading.....	701
121.14	Metadata.....	703
121.15	Blueprint XML Schema.....	704
121.16	Security.....	721
121.17	org.osgi.service.blueprint.container.....	721
121.18	org.osgi.service.blueprint.reflect.....	731
121.19	References.....	741
<b>122</b>	<b>Remote Service Admin Service Specification</b>	<b>743</b>
122.1	Introduction.....	743
122.2	Actors.....	746
122.3	Topology Managers.....	747
122.4	Endpoint Description.....	748
122.5	Remote Service Admin.....	752
122.6	Discovery.....	757
122.7	Events.....	761
122.8	Endpoint Description Extender Format.....	763
122.9	Capability Namespaces.....	768
122.10	Advice to implementations.....	770
122.11	Security.....	771

122.12	org.osgi.service.remoteserviceadmin.....	772
122.13	org.osgi.service.remoteserviceadmin.namespace.....	788
122.14	References.....	789
122.15	Changes.....	789
<b>123</b>	<b>JTA Transaction Services Specification</b>	<b>791</b>
123.1	Introduction.....	791
123.2	JTA Overview.....	793
123.3	Application.....	795
123.4	Resource Managers.....	798
123.5	The JTA Provider.....	798
123.6	Life Cycle.....	799
123.7	Security.....	800
123.8	References.....	800
<b>125</b>	<b>JDBC™ Service Specification</b>	<b>801</b>
125.1	Introduction.....	801
125.2	Database Driver.....	802
125.3	Applications.....	803
125.4	Security.....	804
125.5	org.osgi.service.jdbc.....	805
125.6	References.....	807
<b>126</b>	<b>JNDI Services Specification</b>	<b>809</b>
126.1	Introduction.....	809
126.2	JNDI Overview.....	812
126.3	JNDI Context Manager Service.....	814
126.4	JNDI Provider Admin service.....	817
126.5	JNDI Providers.....	817
126.6	OSGi URL Scheme.....	820
126.7	Traditional Client Model.....	822
126.8	Security.....	824
126.9	org.osgi.service.jndi.....	825
126.10	References.....	827
<b>127</b>	<b>JPA Service Specification</b>	<b>829</b>
127.1	Introduction.....	829
127.2	JPA Overview.....	831
127.3	Bundles with Persistence.....	835
127.4	Extending a Persistence Bundle.....	837
127.5	JPA Provider.....	841
127.6	Static Access.....	843
127.7	Security.....	843
127.8	org.osgi.service.jpa.....	844

127.9	References.....	844
<b>128</b>	<b>Web Applications Specification</b>	<b>847</b>
128.1	Introduction.....	847
128.2	Web Container.....	849
128.3	Web Application Bundle.....	850
128.4	Web URL Handler.....	854
128.5	Events.....	857
128.6	Interacting with the OSGi Environment.....	858
128.7	Security.....	859
128.8	References.....	859
<b>130</b>	<b>Coordinator Service Specification</b>	<b>861</b>
130.1	Introduction.....	861
130.2	Usage.....	862
130.3	Coordinator Service.....	871
130.4	Security.....	876
130.5	org.osgi.service.coordinator.....	877
130.6	References.....	888
<b>132</b>	<b>Repository Service Specification</b>	<b>889</b>
132.1	Introduction.....	889
132.2	Using a Repository.....	890
132.3	Repository.....	894
132.4	org.osgi.content Namespace.....	894
132.5	XML Repository Format.....	895
132.6	XML Repository Schema.....	898
132.7	Capabilities.....	902
132.8	Security.....	902
132.9	org.osgi.service.repository.....	903
132.10	References.....	908
132.11	Changes.....	909
<b>133</b>	<b>Service Loader Mediator Specification</b>	<b>911</b>
133.1	Introduction.....	911
133.2	Java Service Loader API.....	913
133.3	Consumers.....	914
133.4	Service Provider Bundles.....	916
133.5	Service Loader Mediator.....	918
133.6	org.osgi.serviceloader Namespace.....	921
133.7	Use of the org.osgi.extender Namespace.....	921
133.8	Security.....	922
133.9	org.osgi.service.serviceloader.....	922
133.10	References.....	923

<b>134</b>	<b>Subsystem Service Specification</b>	<b>925</b>
134.1	Introduction.....	925
134.2	Subsystems.....	928
134.3	Subsystem Region.....	935
134.4	Subsystem Relationships.....	936
134.5	Determining Content.....	939
134.6	Determining Dependencies.....	944
134.7	Accepting Dependencies.....	945
134.8	Sharing Capabilities.....	947
134.9	Region Context Bundle.....	948
134.10	Explicit and Implicit Resources.....	948
134.11	Resource References.....	952
134.12	Starting and Stopping Resources.....	953
134.13	Subsystem Service.....	955
134.14	Subsystem Life Cycle.....	958
134.15	Pre-Calculated Deployment.....	963
134.16	Subsystem Types.....	968
134.17	Weaving Hooks.....	972
134.18	Stopping and Uninstalling Subsystems Implementation.....	973
134.19	Capabilities.....	973
134.20	Security.....	973
134.21	org.osgi.service.subsystem.....	975
134.22	References.....	991
134.23	Changes.....	991
<b>135</b>	<b>Common Namespaces Specification</b>	<b>993</b>
135.1	Introduction.....	993
135.2	org.osgi.extender Namespace.....	993
135.3	org.osgi.contract Namespace.....	995
135.4	org.osgi.service Namespace.....	997
135.5	org.osgi.implementation Namespace.....	997
135.6	org.osgi.namespace.contract.....	998
135.7	org.osgi.namespace.extender.....	999
135.8	org.osgi.namespace.service.....	999
135.9	org.osgi.namespace.implementation.....	1000
135.10	References.....	1001
135.11	Changes.....	1001
<b>136</b>	<b>Resolver Service Specification</b>	<b>1003</b>
136.1	Introduction.....	1003
136.2	The Resolve Context.....	1005
136.3	Resolver Service.....	1013
136.4	Security.....	1015



---

136.5	org.osgi.service.resolver.....	1015
136.6	References.....	1019
<b>137</b>	<b>REST Management Service Specification</b>	<b>1021</b>
137.1	Introduction.....	1021
137.2	Interacting with the REST Management Service.....	1022
137.3	Resources.....	1024
137.4	Representations.....	1029
137.5	Clients.....	1034
137.6	Extending the REST Management Service.....	1035
137.7	XML Schema.....	1036
137.8	Capabilities.....	1040
137.9	Security.....	1041
137.10	org.osgi.service.rest.....	1041
137.11	org.osgi.service.rest.client.....	1042
137.12	JavaScript Client API.....	1047
137.13	References.....	1050
<b>138</b>	<b>Asynchronous Service Specification</b>	<b>1053</b>
138.1	Introduction.....	1053
138.2	Usage.....	1054
138.3	Async Service.....	1057
138.4	The Async Mediator.....	1058
138.5	Fire and Forget Invocations.....	1059
138.6	Delegating to Asynchronous Implementations.....	1060
138.7	Capabilities.....	1061
138.8	Security.....	1061
138.9	org.osgi.service.async.....	1062
138.10	org.osgi.service.async.delegate.....	1064
138.11	References.....	1065
<b>140</b>	<b>Http Whiteboard Specification</b>	<b>1067</b>
140.1	Introduction.....	1067
140.2	The Servlet Context.....	1068
140.3	Common Whiteboard Properties.....	1073
140.4	Registering Servlets.....	1074
140.5	Registering Servlet Filters.....	1078
140.6	Registering Resources.....	1080
140.7	Registering Listeners.....	1081
140.8	Lifecycle.....	1082
140.9	The Http Service Runtime Service.....	1083
140.10	Configuration Properties.....	1085
140.11	Capabilities.....	1085
140.12	Security.....	1086

140.13	org.osgi.service.http.context .....	1087
140.14	org.osgi.service.http.runtime .....	1090
140.15	org.osgi.service.http.runtime.dto .....	1092
140.16	org.osgi.service.http.whiteboard .....	1101
140.17	References .....	1106
<b>702</b>	<b>XML Parser Service Specification</b>	<b>1107</b>
702.1	Introduction .....	1107
702.2	JAXP .....	1108
702.3	XML Parser service .....	1109
702.4	Properties .....	1109
702.5	Getting a Parser Factory .....	1109
702.6	Adapting a JAXP Parser to OSGi .....	1110
702.7	Usage of JAXP .....	1111
702.8	Security .....	1112
702.9	org.osgi.util.xml .....	1112
702.10	References .....	1115
<b>703</b>	<b>Position Specification</b>	<b>1117</b>
703.1	Introduction .....	1117
703.2	Positioning .....	1117
703.3	Units .....	1118
703.4	Optimizations .....	1118
703.5	Errors .....	1118
703.6	Using Position With Wire Admin .....	1118
703.7	Related Standards .....	1119
703.8	Security .....	1119
703.9	org.osgi.util.position .....	1119
703.10	References .....	1120
<b>704</b>	<b>Measurement and State Specification</b>	<b>1121</b>
704.1	Introduction .....	1121
704.2	Measurement Object .....	1122
704.3	Error Calculations .....	1123
704.4	Constructing and Comparing Measurements .....	1123
704.5	Unit Object .....	1124
704.6	State Object .....	1126
704.7	Related Standards .....	1126
704.8	Security Considerations .....	1126
704.9	org.osgi.util.measurement .....	1126
704.10	References .....	1134
<b>705</b>	<b>Promises Specification</b>	<b>1137</b>
705.1	Introduction .....	1137

---

705.2	Promise.....	1138
705.3	Deferred.....	1138
705.4	Callbacks.....	1139
705.5	Chaining Promises.....	1140
705.6	Monad.....	1140
705.7	Functional Interfaces.....	1142
705.8	Promises Class.....	1142
705.9	Security.....	1142
705.10	org.osgi.util.promise.....	1142
705.11	org.osgi.util.function.....	1151
705.12	References.....	1152

## **999 Execution Environment Specification 1153**

999.1	Introduction.....	1153
999.2	About Execution Environments.....	1154
999.3	OSGi Defined Execution Environments.....	1154
999.4	References.....	1197



# 1 Introduction

This compendium contains the specifications of all current OSGi services.

## 1.1 Reader Level

This specification is written for the following audiences:

- Application developers
- Framework and system service developers (system developers)
- Architects

This specification assumes that the reader has at least one year of practical experience in writing Java programs. Experience with embedded systems and server-environments is a plus. Application developers must be aware that the OSGi environment is significantly more dynamic than traditional desktop or server environments.

System developers require a *very* deep understanding of Java. At least three years of Java coding experience in a system environment is recommended. A Framework implementation will use areas of Java that are not normally encountered in traditional applications. Detailed understanding is required of class loaders, garbage collection, Java 2 security, and Java native library loading.

Architects should focus on the introduction of each subject. This introduction contains a general overview of the subject, the requirements that influenced its design, and a short description of its operation as well as the entities that are used. The introductory sections require knowledge of Java concepts like classes and interfaces, but should not require coding experience.

Most of these specifications are equally applicable to application developers and system developers.

## 1.2 Version Information

This document is the Compendium Specification for the OSGi Compendium Release 6.

### 1.2.1 OSGi Core Release 6

This specification is based on the OSGi Core Release 6. This specification can be downloaded from:

<http://www.osgi.org/Specifications/HomePage>

### 1.2.2 Component Versions

Components in this specification have their own specification version, independent of this specification. The following table summarizes the packages and specification versions for the different subjects.

*Table 1.1 Packages and versions*

Item	Package	Version
100 Remote Services	-	Version 1.0
101 Log Service Specification	org.osgi.service.log	Version 1.3
102 Http Service Specification	org.osgi.service.http	Version 1.2
103 Device Access Specification	org.osgi.service.device	Version 1.1

Item	Package	Version
104 <i>Configuration Admin Service Specification</i>	org.osgi.service.cm	Version 1.5
105 <i>Metatype Service Specification</i>	org.osgi.service.metatype	Version 1.3
	org.osgi.service.metatype.annotations	
106 <i>PreferencesService Specification</i>	org.osgi.service.prefs	Version 1.1
107 <i>User Admin Service Specification</i>	org.osgi.service.useradmin	Version 1.1
108 <i>Wire Admin Service Specification</i>	org.osgi.service.wireadmin	Version 1.0
109 <i>IO Connector Service Specification</i>	org.osgi.service.io	Version 1.0
110 <i>Initial Provisioning Specification</i>	org.osgi.service.provisioning	Version 1.2
111 <i>UPnP™ Device Service Specification</i>	org.osgi.service.upnp	Version 1.2
112 <i>Declarative Services Specification</i>	org.osgi.service.component	Version 1.3
	org.osgi.service.component.annotations	
	org.osgi.service.component.runtime	
	org.osgi.service.component.runtime.dto	
113 <i>Event Admin Service Specification</i>	org.osgi.service.event	Version 1.3
114 <i>Deployment Admin Specification</i>	org.osgi.service.deploymentadmin	Version 1.1
	org.osgi.service.deploymentadmin.spi	
115 <i>Auto Configuration Specification</i>	-	Version 1.0
116 <i>Application Admin Specification</i>	org.osgi.service.application	Version 1.1
117 <i>Dmt Admin Service Specification</i>	org.osgi.service.dmt	Version 2.0
	org.osgi.service.dmt.notification	
	org.osgi.service.dmt.notification.spi	
	org.osgi.service.dmt.security	
	org.osgi.service.dmt.spi	
119 <i>Monitor Admin Service Specification</i>	org.osgi.service.monitor	Version 1.0
120 <i>Foreign Application Access Specification</i>	org.osgi.application	Version 1.0
121 <i>Blueprint Container Specification</i>	org.osgi.service.blueprint.container	Version 1.0
	org.osgi.service.blueprint.reflect	
122 <i>Remote Service Admin Service Specification</i>	org.osgi.service.remoteserviceadmin	Version 1.1
123 <i>JTA Transaction Services Specification</i>	-	Version 1.0
125 <i>JDBC™ Service Specification</i>	org.osgi.service.jdbc	Version 1.0
126 <i>JNDI Services Specification</i>	org.osgi.service.jndi	Version 1.0
127 <i>JPA Service Specification</i>	org.osgi.service.jpa	Version 1.0
128 <i>Web Applications Specification</i>	-	Version 1.0
130 <i>Coordinator Service Specification</i>	org.osgi.service.coordinator	Version 1.0
132 <i>Repository Service Specification</i>	org.osgi.service.repository	Version 1.1
133 <i>Service Loader Mediator Specification</i>	org.osgi.service.serviceloader	Version 1.0
134 <i>Subsystem Service Specification</i>	org.osgi.service.subsystem	Version 1.1
135 <i>Common Namespaces Specification</i>	org.osgi.namespace.contract	Version 1.1
	org.osgi.namespace.extender	
	org.osgi.namespace.implementation	
	org.osgi.namespace.service	
136 <i>Resolver Service Specification</i>	org.osgi.service.resolver	Version 1.0

Item	Package	Version
137 <i>REST Management Service Specification</i>	org.osgi.service.rest	Version 1.0
138 <i>Asynchronous Service Specification</i>	org.osgi.service.async	Version 1.0
140 <i>Http Whiteboard Specification</i>	org.osgi.service.async.delegate	Version 1.0
	org.osgi.service.http.whiteboard	
	org.osgi.service.http.context	
702 <i>XML Parser Service Specification</i>	org.osgi.service.http.runtime	Version 1.0
	org.osgi.service.http.runtime.dto	
	org.osgi.util.xml	
703 <i>Position Specification</i>	org.osgi.util.position	Version 1.0
704 <i>Measurement and State Specification</i>	org.osgi.util.measurement	Version 1.0
705 <i>Promises Specification</i>	org.osgi.util.promise	Version 1.0
999 <i>Execution Environment Specification</i>	org.osgi.util.function	Version 1.3
	-	

When a component is represented in a bundle, a version attribute is needed in the declaration of the Import-Package or Export-Package manifest headers.

## 1.3 References

- [1] *OSGi Specifications*  
<http://www.osgi.org/Specifications/HomePage>

## 1.4 Changes

- Updated *Metatype Service Specification* on page 131.
- Updated *Declarative Services Specification* on page 289.
- Updated *Remote Service Admin Service Specification* on page 743.
- Updated *Repository Service Specification* on page 889.
- Updated *Subsystem Service Specification* on page 925.
- Updated *Common Namespaces Specification* on page 993.
- Added *REST Management Service Specification* on page 1021.
- Added *Asynchronous Service Specification* on page 1053.
- Added *Http Whiteboard Specification* on page 1067.
- Added *Promises Specification* on page 1137.





# 100 Remote Services

## Version 1.0

The OSGi framework provides a *local* service registry for bundles to communicate through service objects, where a service is an object that one bundle registers and another bundle gets. A *distribution provider* can use this loose coupling between bundles to *export* a registered service by creating an *endpoint*. Vice versa, the distribution provider can create a *proxy* that accesses an endpoint and then registers this proxy as an *imported* service. A Framework can contain multiple distribution providers simultaneously, each independently importing and exporting services.

An endpoint is a communications access mechanisms to a service in another framework, a (web) service, another process, or a queue or topic destination, etc., requiring some protocol for communications. The constellation of the mapping between services and endpoints as well as their communication characteristics is called the *topology*. A common case for distribution providers is to be present on multiple frameworks importing and exporting services; effectively distributing the service registry.

The local architecture for remote services is depicted in Figure 100.1 on page 21.

Figure 100.1 Architecture

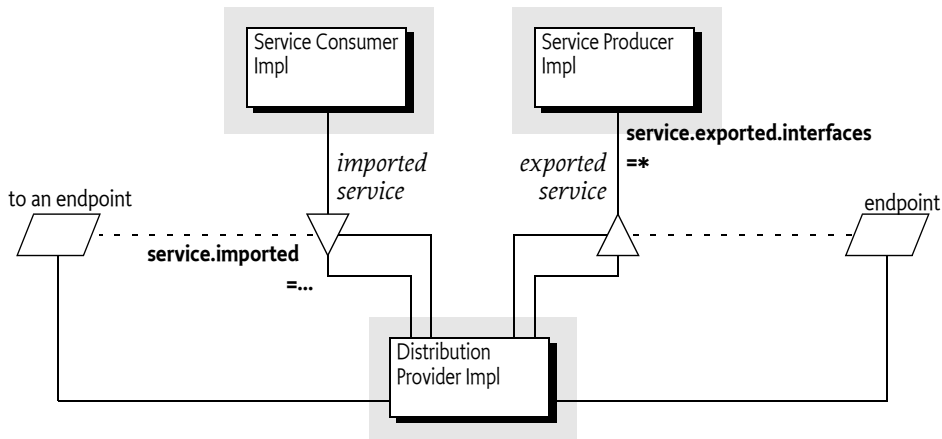

Local services imply in-VM call semantics. Many of these semantics cannot be supported over a communications connection, or require special configuration of the communications connection. It is therefore necessary to define a mechanism for bundles to convey their assumptions and requirements to the distribution provider. This chapter defines a number of service properties that a distribution provider can use to establish a topology while adhering to the given constraints.

## 100.1 The Fallacies

General abstractions for distributed systems have been tried before and often failed. Well known are the fallacies described in [1] *The Fallacies of Distributed Computing Explained*:

- The network is reliable

- Latency is zero
- Bandwidth is infinite
- The network is secure
- Topology doesn't change
- There is one administrator
- Transport cost is zero
- The network is homogeneous

Most fallacies represent non-functional trade-offs that should be considered by administrators, their decisions can then be reflected in the topology. For example, in certain cases limited bandwidth is acceptable and the latency in a datacenter is near zero. However, the reliability fallacy is the hardest because it intrudes into the application code. If a communication channel is lost, the application code needs to take specific actions to recover from this failure.

This reliability aspect is also addressed with OSGi services because services are dynamic. Failures in the communications layer can be mapped to the unregistration of the imported service. OSGi bundles are already well aware of these dynamics, and a number of programming models have been developed to minimize the complexity of writing these dynamic applications.

## 100.2 Remote Service Properties

This section introduces a number of properties that participating bundles can use to convey information to the distribution provider according to this Remote Service specification.

The following table lists the properties that must be listed by a distribution provider.

Table 100.1

*Remote Service Properties registered by the Distribution Provider*

Service Property Name	Type	Description
remote.configs.supported	String+	Registered by the distribution provider on one of its services to indicate the supported configuration types. See <i>Configuration Types</i> on page 27 and <i>Dependencies</i> on page 30.
remote.intents.supported	String+	Registered by the distribution provider on one of its services to indicate the vocabulary of implemented intents. See <i>Dependencies</i> on page 30.
service.imported	*	Must be set by a distribution provider to any value when it registers the endpoint proxy as an imported service. A bundle can use this property to filter out imported services.
service.imported.configs	String+	The configuration information used to import this service, as described in <code>service.exported.configs</code> . Any associated properties for this configuration types must be properly mapped to the importing system. For example, a URL in these properties must point to a valid resource when used in the importing framework.  If multiple configuration types are listed in this property, then they must be synonyms for exactly the same remote endpoint that is used to export this service.

Service Property Name	Type	Description
service.intents	String+	<p>A distribution provider must use this property to convey the combined intents of:</p> <ul style="list-style-type: none"> <li>• The exporting service, and</li> <li>• The intents that the exporting distribution provider adds.</li> <li>• The intents that the importing distribution provider adds.</li> </ul>

The properties for bundles providing services to be exported or require services to be imported are listed alphabetically in the following table. The scenarios that these properties are used in are discussed in later sections.

Table 100.2 Remote Service Properties registered by Exporting bundles

Service Property Name	Type	Description
service.exported.configs	String+	A list of configuration types that should be used to export the service. Each configuration type represents the configuration parameters for one or more Endpoints. A distribution provider should create endpoints for each configuration type that it supports. See <i>Configuration Types</i> on page 27 for more details. If this property is not set or empty a distribution provider is free to choose a default configuration type for the service.
service.exported.intents	String+	A list of <i>intents</i> that the distribution provider must implement to distribute the service. Intents listed in this property are reserved for intents that are critical for the code to function correctly, for example, ordering of messages. These intents should not be configurable. For more information about intents, see <i>Intents</i> on page 26. This property is optional.
service.exported.intents.extra	String+	This property is merged with the <code>service.exported.intents</code> property before the distribution provider interprets the listed intents; it has therefore the same semantics but the property should be configurable so the administrator can choose the intents based on the topology. Bundles should therefore make this property configurable, for example through the Configuration Admin service. See <i>Intents</i> on page 26. This property is optional. If absent or empty no specific intents are required.
service.exported.interfaces	String+	Setting this property marks this service for export. It defines the interfaces under which this service can be exported. This list must be a subset of the types listed in the <code>objectClass</code> service property. The single value of an asterisk ('*' \u002A) indicates all interfaces in the registration's <code>objectClass</code> property and ignore the classes. It is strongly recommended to only export interfaces and not concrete classes due to the complexity of creating proxies for some type of concrete classes. See <i>Registering a Service for Export</i> on page 24.

Service Property Name	Type	Description
service.intents	String+	<p>A list of intents that this service implements. A distribution provider must use this property to convey the combined intents of:</p> <ul style="list-style-type: none"> <li>• The exporting service, and</li> <li>• The intents that the exporting distribution provider adds.</li> <li>• The intents that the importing distribution provider adds.</li> </ul> <p>To export a service, a distribution provider must expand any qualified intents to include those supported by the endpoint. This can be a subset of all known qualified intents. See <i>Intents</i> on page 26. This property is optional for registering bundles.</p>
service.pid	String+	<p>Services that are exported should have a service.pid property. The service.pid (PID) is a unique persistent identity for the service, the PID is defined in <i>Persistent Identifier (PID) of OSGi Core Release 6</i>. This property enables a distribution provider to associate persistent proprietary data with a service registration.</p>

The properties and their treatment by the distribution provider is depicted in Figure 100.2.

Figure 100.2 Distribution Service Properties

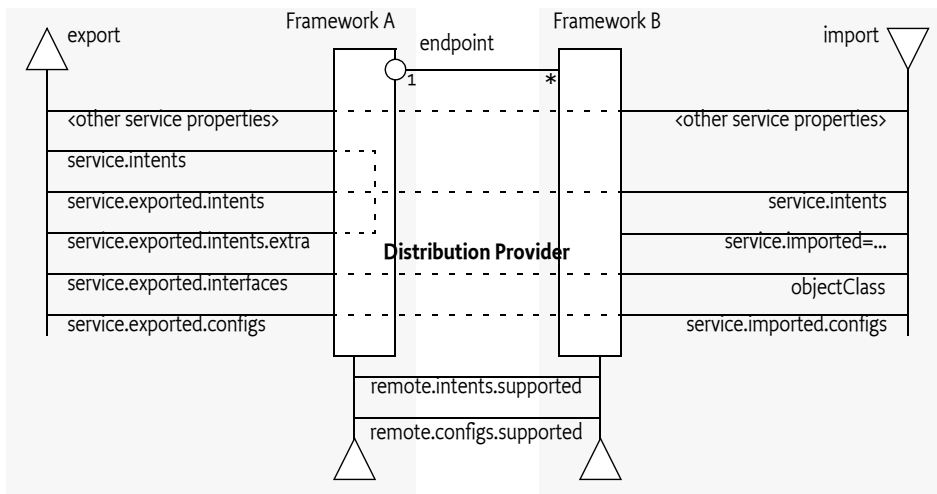

### 100.2.1 Registering a Service for Export

A distribution provider should create one or more endpoints for an exported service when the following conditions are met:

- The service has the service property service.exported.interfaces set.
- All intents listed in service.exported.intents, service.exported.intents.extra and service.intents are part of the distributed provider's vocabulary
- None of the intents are mutually exclusive.

- The distribution provider can use the configuration types in `service.exported.configs` to create one or more endpoints.

The endpoint must at least implement all the intents that are listed in the `service.exported.intents` and `service.exported.intents.extra` properties.

The configuration types listed in the `service.exported.configs` can contain *alternatives* and/or *synonyms*. Alternatives describe different endpoints for the same service while a synonym describes a different configuration type for the same endpoint.

A distribution provider should create endpoints for each of the configuration types it supports; these configuration types should be alternatives. Synonyms are allowed.

If no configuration types are recognized, the distribution provider should create an endpoint with a default configuration type except when one of the listed configuration types is `<<nodefault>>`.

For more information about the configuration types, see further *Configuration Types* on page 27.

### 100.2.2 Getting an Imported Service

An imported service must be a normal service, there are therefore no special rules for getting it. An imported service has a number of additional properties that must be set by the distribution provider.

If the endpoint for an exported service is imported as an OSGi service in another framework, then the following properties must be treated as special.

- `service.imported` - Must be set to some value.
- `service.intents` - This must be the combination of the following:
  - The `service.intents` property on the exported service
  - The `service.exported.intents` and `service.exported.intents.extra` properties on the exported service
  - Any additional intents implemented by the distribution providers on both sides.
- `service.imported.configs` - Contains the configuration types that can be used to import this service. The types listed in this property must be *synonymous*, that is, they must refer to exactly the same endpoint that is exporting the service. See *Configuration Types* on page 27.
- `service.exported.*` - Properties starting with `service.exported.` must not be set on the imported service.
- `service.exported.interfaces` - This property must not be set, its content is reflected in the object-Class property.

All other *public* service properties (not starting with a full stop (`' \u002E`)) must be listed on the imported service if they use the basic service property types. If the service property cannot be communicated because, for example, it uses a type that can not be marshaled by the distribution provider then the distribution provider must ignore this property.

The `service.imported` property indicates that a service is an imported service. If this service property is set to any value, then the imported service is a proxy for an endpoint. If a bundle wants to filter out imported services, then it can add the following filter:

```
(&(! (service.imported=*)) <previousfilter>)
```

Distribution providers can also use the *Service Hook Service Specification* of *OSGi Core Release 6* to hide services from specific bundles.

### 100.2.3 On Demand Import

The Service Hooks Service Specification of *OSGi Core Release 6*, allows a distribution provider to detect when a bundle is listening for specific services. Bundles can request imported services with spe-

cific intents by building an appropriate filter. The distribution provider can use this information to import a service on demand.

The following example creates a Service Tracker that is interested in an imported service.

```
Filter f = context.createFilter(
    "&(objectClass=com.acme.Foo)"
    + "(service.intents=confidentiality)");
ServiceTracker tracker =
    new ServiceTracker(context, f, null);
tracker.open();
```

Such a Service Tracker will inform the Listener Hook and will give it the filter expression. If the distribution provider has registered such a hook, it will be informed about the need for an imported `com.acme.Foo` service that has a confidentiality intent. It can then use some proprietary means to find a service to import that matches the given object class and intent.

How the distribution provider finds an appropriate endpoint is out of scope for this specification.

## 100.3 Intents

An intent is a name for an abstract distribution capability. An intent can be *implemented* by a service; this can then be reflected in the `service.intents` property. An intent can also *constrain* the possible communication mechanisms that a distribution provider can choose to distribute a service. This is reflected in the `service.export.intents` and `service.exported.intents.extra` properties.

The purpose of the intents is to have a *vocabulary* that is shared between distribution aware bundles and the distribution provider. This vocabulary allows the bundles to express constraints on the export of their services as well as providing information on what intents are implemented by a service.

Intents have the following syntax

```
intent ::= token ( '.' token )?
```

*Qualified intents* use a full stop (`'\u002E'`) to separate the intent from the qualifier. A qualifier provides additional details, however, it implies its prefix. For example:

```
confidentiality.message
```

This example, can be *expanded* into `confidentiality` and `confidentiality.message`. Qualified intents can be used to provide additional details how an intent is achieved. However, a Distribution Provider must expand any qualified intents to include those supported by the endpoint. This can be a subset of all known qualified intents.

The concept of intents is derived from the [3] *SCA Policy Framework specification*. When designing a vocabulary for a distribution provider it is recommended to closely follow the vocabulary of intents defined in the SCA Policy Framework.

## 100.4 General Usage

### 100.4.1 Call by Value

Normal service semantics are call-by-reference. An object passed as an argument in a service call is a direct reference to that object. Any changes to this object will be shared on both sides of the service registry.

Distributed services are different. Arguments are normally passed by value, which means that a copy is sent to the remote system, changes to this value are not reflected in the originating framework. When using distributed services, call-by-value should always be assumed by all participants in the distribution chain.

### 100.4.2 Data Fencing

Services are syntactically defined by their Java interfaces. When exposing a service over a remote protocol, typically such an interface is mapped to a protocol-specific interface definition. For example, in CORBA the Java interfaces would be converted to a corresponding IDL definition. This mapping does not always result in a complete solution.

Therefore, for many practical distributed applications it will be necessary to constrain the possible usage of data types in service interfaces. A distribution provider must at least support interfaces (not classes) that only use the basic types as defined for the service properties. These are the primitive types and their wrappers as well as arrays and collections. See *Filter Syntax of OSGi Core Release 6* for a list of service property types.

Distribution providers will in general provide a richer set of types that can be distributed.

### 100.4.3 Remote Services Life Cycle

A distributed service must closely track any modifications on the corresponding service registration. If service properties are modified, these modifications should be propagated to the distributed service and associated service proxies. If the exported service is unregistered, the endpoint must be withdrawn as soon as possible and any imported service proxies unregistered.

### 100.4.4 Runtime

An imported service is just like any other service and can be used as such. However, certain non-functional characteristics of this service can differ significantly from what is normal for an in-VM object call. Many of these characteristics can be mapped to the normal service operations. That is, if the connection fails in any way, the service can be unregistered. According to the standard OSGi contract, this means that the users of that service must perform the appropriate cleanup to prevent stale references.

### 100.4.5 Exceptions

It is impossible to guarantee that a service is not used when it is no longer valid. Even with the synchronous callbacks from the Service Listeners, there is always a finite window where a service can be used while the underlying implementation has failed. In a distributed environment, this window can actually be quite large for an imported service.

Such failure situations must be exposed to the application code that uses a failing imported service. In these occasions, the distribution provider must notify the application by throwing a Service Exception, or subclass thereof, with the reason REMOTE. The Service Exception is a Runtime Exception, it can be handled higher up in the call chain. The cause of this Service Exception must be the Exception that caused the problem.

A distribution provider should log any problems with the communications layer to the Log Service, if available.

## 100.5 Configuration Types

An exported service can have a `service.exported.configs` service property. This property lists configuration types for endpoints that are provided for this service. Each type provides a specification that defines how the configuration data for one or more endpoints is provided. For example, a hypothetical configuration type could use a service property to hold a URL for the RMI naming registry.

Configuration types that are not defined by the OSGi Alliance should use a name that follows the reverse capabilities domain name scheme defined in [4] *Java Language Specification* for Java packages. For example, com.acme.wsdl would be the proprietary way for the ACME company to specify a WSDL configuration type.

### 100.5.1 Configuration Type Properties

The service.exported.configs and service.imported.configs use the configuration types in very different ways. That is, the service.imported.configs property is not a copy of the service.exported.configs as the name might seem to imply.

An exporting service can list its desired configuration types in the service.exported.configs property. This property is potentially seen and interpreted by multiple distribution providers. Each of these providers can independently create endpoints from the configuration types. In principle, the service.exported.configs lists *alternatives* for a single distribution provider and can list *synonyms* to support alternative distribution providers. If only one of the synonyms is useful, there is an implicit assumption that when the service is exported, only one of the synonyms should be supported by the installed distribution providers. If it is detected that this assumption is violated, then an error should be logged and the conflicting configuration is further ignored.

The interplay of synonyms and alternatives is depicted in Table 100.3. In this table, the first columns on the left list different combinations of the configuration types in the service.exported.configs property. The next two columns list two distribution providers that each support an overlapping set of configuration types. The x's in this table indicate if a configuration type or distribution provider is active in a line. The description then outlines the issues, if any. It is assumed in this table that hypothetical configuration types net.rmi and com.rmix map to an identical endpoint, just like net.soap and net.soapx.

Table 100.3 Synonyms and Alternatives in Exported Configurations

service.exported.configs				Distribution Provider A	Distribution Provider B	Description
			<<no default>>	Supports:	Supports:	
net.rmi	com.rmix	net.soap	com.soapx	net.rmi	net.rmi	
				com.rmix	net.soap	
				com.soapx		
x	x			x		Ok, A will create an endpoint for the RMI and SOAP alternatives.
x				x	x	Configuration error. There is a clash for net.rmi because A and B can both create an endpoint for the same configuration. It is likely that one will fail.
		x	x	x		Ok, exported on com.soapx by A, the net.soap is ignored.
		x	x	x	x	Synonym error because A and B export to same SOAP endpoint, it is likely that one will fail.
x	x			x	x	Ok, two alternative endpoints over RMI (by A) and SOAP (by B) are created. This is a typical use case.
		x	x	x		Ok. Synonyms are used to allow frameworks that have either A or B installed. In this case A exports over SOAP.
		x	x		x	Ok. Synonyms are used to allow frameworks that have either A or B installed. In this case B exports.
					x	Ok. A creates an endpoint with default configuration type.



<b>service.exported.configs</b>	<b>Distribution Provider A</b>	<b>Distribution Provider B</b>	<b>Description</b>
	x	x	<i>Ok</i> Both A and B each create an endpoint with their default configuration type.
	x x		<i>Ok</i> No endpoint is created.
x x		x	Provider B does not recognize the configuration types it should therefore use a default configuration type.

To summarize, the following rules apply for a single distribution provider:

- Only configuration types that are supported by this distribution provider must be used. All other configuration types must be ignored.
- All of the supported configuration types must be *alternatives*, that is, they must map to different endpoints. Synonyms for the same distribution provider should be logged as errors.
- If a configuration type results in an endpoint that is already in use, then an error should be logged. It is likely then that another distribution provider already had created that endpoint.

An export of a service can therefore result in multiple endpoints being created. For example, a service can be exported over RMI as well as SOAP. Creating an endpoint can fail, in that case the distribution provider must log this information in the Log Service, if available, and not export the service to that endpoint. Such a failure can, for example, occur when two configuration types are synonym and multiple distribution providers are installed that supporting this type.

On the importing side, the `service.imported.configs` property lists configuration types that must refer to the same endpoint. That is, it can list alternative configuration types for this endpoint but all configuration types must result in the same endpoint.

For example, there are two distribution providers installed at the exporting and importing frameworks. Distribution provider A supports the hypothetical configuration type `net.rmi` and `net.soap`. Distribution provider B supports the hypothetical configuration type `net.smart`. A service is registered that list all three of those configuration types.

Distribution provider A will create two endpoints, one for RMI and one for SOAP. Distribution provider B will create one endpoint for the smart protocol. The distribution provider A knows how to create the configuration data for the `com.acme.rmi` configuration type as well and can therefore create a synonymous description of the endpoint in that configuration type. It will therefore set the imported configuration type for the RMI endpoint to:

```
service.imported.configs = net.rmi, com.acme.rmi
net.rmi.url = rmi://172.25.25.109:1099/service-id/24
com.acme.rmi.address = 172.25.25.109
com.acme.rmi.port = 1099
com.acme.rmi.path = service-id/24
```

Figure 100.3

Relation between imported and exported configuration types

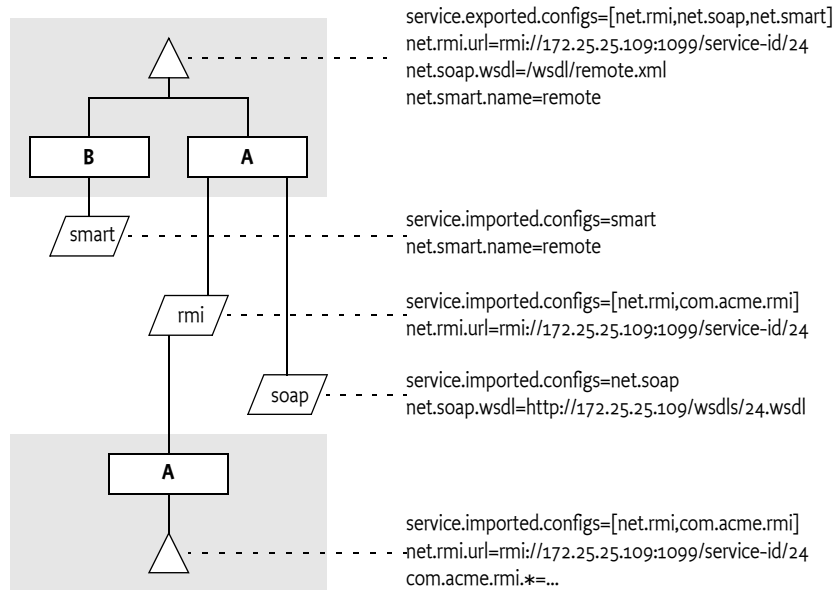

## 100.5.2 Dependencies

A bundle that uses a configuration type has an implicit dependency on the distribution provider. To make this dependency explicit, the distribution provider must register a service with the following properties:

- `remote.intents.supported` - (String+) The vocabulary of the given distribution provider.
- `remote.configs.supported` - (String+) The configuration types that are implemented by the distribution provider.

A bundle that depends on the availability of specific intents or configuration types can create a service dependency on an anonymous service with the given properties. The following filter is an example of depending on a hypothetical `net.rmi` configuration type:

```
(remote.configs.supported=net.rmi)
```

## 100.6 Security

The distribution provider will be required to invoke methods on any exported service. This implies that it must have the combined set of permissions of all methods it can call. It also implies that the distribution provider is responsible for ensuring that a bundle that calls an imported service is not granted additional permissions through the fact that the distribution provider will call the exported service, not the original invoker.

The actual mechanism to ensure that bundles can get additional permissions through the distribution is out of scope for this specification. However, distribution providers should provide mechanisms to limit the set of available permissions for a remote invocation, preferably on a small granularity basis.

One possible means is to use the `getAccessControlContext` method on the Conditional Permission Admin service to get an Access Control Context that is used in a `doPrivileged` block where the invocation takes place. The `getAccessControlContext` method takes a list of signers which could repre-

sent the remote bundles that cause an invocation. How these are authenticated is up to the distribution provider.

A distribution provider is a potential attack point for intruders. Great care should be taken to properly setup the permissions or topology in an environment that requires security.

### 100.6.1 Limiting Exports and Imports

Service registration and getting services is controlled through the ServicePermission class. This permission supports a filter based constructor that can assert service properties. This facility can be used to limit bundles from being able to register exported services or get imported services if they are combined with Conditional Permission Admin's ALLOW facility. The following example shows how all bundles except from www.acme.com are denied the registration and getting of distributed services.

```
DENY {
    [...BundleLocationCondition("http://www.acme.com/*" "!")]
    (...ServicePermission "(service.imported=*)" "GET" )
    (...ServicePermission "(service.exported.interfaces=*)"
        "REGISTER" )
}
```

## 100.7 References

- [1] *The Fallacies of Distributed Computing Explained*  
<http://www.rgoarchitects.com/Files/fallacies.pdf>
- [2] *Service Component Architecture (SCA)*  
<http://www.oasis-opencsa.org/>
- [3] *SCA Policy Framework specification*  
<http://www.oasis-open.org/committees/sca-policy/>
- [4] *Java Language Specification*  
<http://docs.oracle.com/javase/specs/>



# 101 Log Service Specification

## Version 1.3

### 101.1 Introduction

The Log Service provides a general purpose message logger for the OSGi framework. It consists of two services, one for logging information and another for retrieving current or previously recorded log information.

This specification defines the methods and semantics of interfaces which bundle developers can use to log entries and to retrieve log entries.

Bundles can use the Log Service to log information for the Operator. Other bundles, oriented toward management of the environment, can use the Log Reader Service to retrieve Log Entry objects that were recorded recently or to receive Log Entry objects as they are logged by other bundles.

#### 101.1.1 Entities

- *LogService* - The service interface that allows a bundle to log information, including a message, a level, an exception, a ServiceReference object, and a Bundle object.
- *LogEntry* - An interface that allows access to a log entry in the log. It includes all the information that can be logged through the Log Service and a time stamp.
- *LogReaderService* - A service interface that allows access to a list of recent LogEntry objects, and allows the registration of a LogListener object that receives LogEntry objects as they are created.
- *LogListener* - The interface for the listener to LogEntry objects. Must be registered with the Log Reader Service.

Figure 101.1 Log Service Class Diagram org.osgi.service.log package

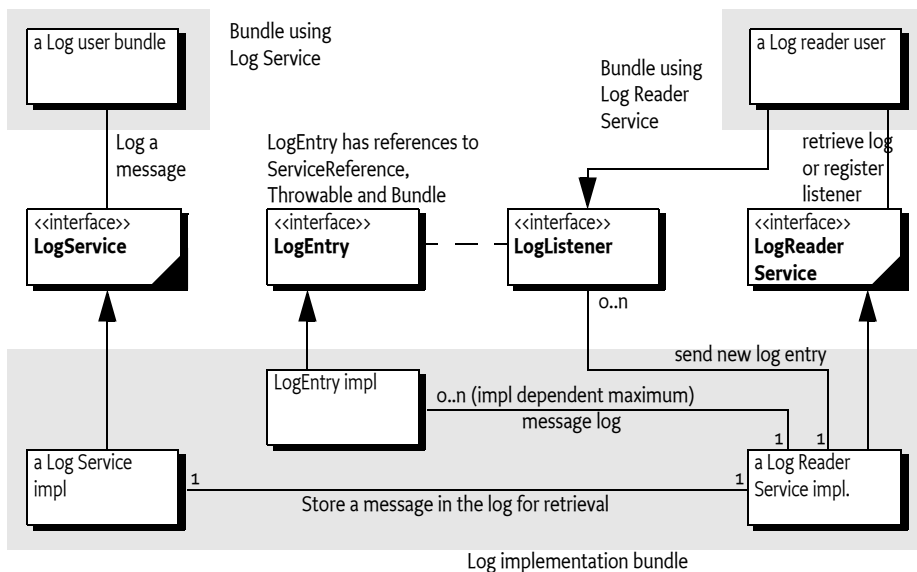

## 101.2 The Log Service Interface

The `LogService` interface allows bundle developers to log messages that can be distributed to other bundles, which in turn can forward the logged entries to a file system, remote system, or some other destination.

The `LogService` interface allows the bundle developer to:

- Specify a message and/or exception to be logged.
- Supply a log level representing the severity of the message being logged. This should be one of the levels defined in the `LogService` interface but it may be any integer that is interpreted in a user-defined way.
- Specify the Service associated with the log requests.

By obtaining a `LogService` object from the Framework service registry, a bundle can start logging messages to the `LogService` object by calling one of the `LogService` methods. A `LogService` object can log any message, but it is primarily intended for reporting events and error conditions.

The `LogService` interface defines these methods for logging messages:

- `log(int, String)` - This method logs a simple message at a given log level.
- `log(int, String, Throwable)` - This method logs a message with an exception at a given log level.
- `log(ServiceReference, int, String)` - This method logs a message associated with a specific service.
- `log(ServiceReference, int, String, Throwable)` - This method logs a message with an exception associated with a specific service.

While it is possible for a bundle to call one of the log methods without providing a `ServiceReference` object, it is recommended that the caller supply the `ServiceReference` argument whenever appropriate, because it provides important context information to the operator in the event of problems.

The following example demonstrates the use of a log method to write a message into the log.

```
logService.log(  
    myServiceReference,  
    LogService.LOG_INFO,  
    "myService is up and running"  
);
```

In the example, the `myServiceReference` parameter identifies the service associated with the log request. The specified level, `LogService.LOG_INFO`, indicates that this message is informational.

The following example code records error conditions as log messages.

```
try {  
    FileInputStream fis = new FileInputStream("myFile");  
    int b;  
    while ( (b = fis.read()) != -1 ) {  
        ...  
    }  
    fis.close();  
}  
catch ( IOException exception ) {  
    logService.log(  
        myServiceReference,
```

```

        LogService.LOG_ERROR,
        "Cannot access file",
        exception );
    }

```

Notice that in addition to the error message, the exception itself is also logged. Providing this information can significantly simplify problem determination by the Operator.

## 101.3 Log Level and Error Severity

The log methods expect a log level indicating error severity, which can be used to filter log messages when they are retrieved. The severity levels are defined in the LogService interface.

Callers must supply the log levels that they deem appropriate when making log requests.

The following table lists the log levels.

Table 101.1

### Log Levels

Level	Descriptions
LOG_DEBUG	Used for problem determination and may be irrelevant to anyone but the bundle developer.
LOG_ERROR	Indicates the bundle or service may not be functional. Action should be taken to correct this situation.
LOG_INFO	May be the result of any change in the bundle or service and does not indicate a problem.
LOG_WARNING	Indicates a bundle or service is still functioning but may experience problems in the future because of the warning condition.

## 101.4 Log Reader Service

The Log Reader Service maintains a list of LogEntry objects called the *log*. The Log Reader Service is a service that bundle developers can use to retrieve information contained in this log, and receive notifications about LogEntry objects when they are created through the Log Service.

The size of the log is implementation-specific, and it determines how far into the past the log entries go. Additionally, some log entries may not be recorded in the log in order to save space. In particular, LOG\_DEBUG log entries may not be recorded. Note that this rule is implementation-dependent. Some implementations may allow a configurable policy to ignore certain LogEntry object types.

The LogReaderService interface defines these methods for retrieving log entries.

- `getLog()` - This method retrieves past log entries as an enumeration with the most recent entry first.
- `addLogListener(LogListener)` - This method is used to subscribe to the Log Reader Service in order to receive log messages as they occur. Unlike the previously recorded log entries, all log messages must be sent to subscribers of the Log Reader Service as they are recorded.

A subscriber to the Log Reader Service must implement the LogListener interface.

After a subscription to the Log Reader Service has been started, the subscriber's LogListener.logged method must be called with a Log-Entry object for the message each time a message is logged.

The LogListener interface defines the following method:

- `logged(LogEntry)` - This method is called for each Log-Entry object created. A Log Reader Service implementation must not filter entries to the `LogListener` interface as it is allowed to do for its log. A `LogListener` object should see all `LogEntry` objects that are created.

The delivery of `LogEntry` objects to the `LogListener` object should be done asynchronously.

## 101.5 Log Entry Interface

The `LogEntry` interface abstracts a log entry. It is a record of the information that was passed when an event was logged, and consists of a superset of information which can be passed through the `LogService` methods. The `LogEntry` interface defines these methods to retrieve information related to Log-Entry objects:

- `getBundle()` - This method returns the `Bundle` object related to a Log-Entry object.
- `getException()` - This method returns the exception related to a Log-Entry object. In some implementations, the returned exception may not be the original exception. To avoid references to a bundle defined exception class, thus preventing an uninstalled bundle from being garbage collected, the Log Service may return an exception object of an implementation defined `Throwable` subclass. This object will attempt to return as much information as possible, such as the message and stack trace, from the original exception object.
- `getLevel()` - This method returns the severity level related to a Log-Entry object.
- `getMessage()` - This method returns the message related to a Log-Entry object.
- `getServiceReference()` - This method returns the `ServiceReference` object of the service related to a Log-Entry object.
- `getTime()` - This method returns the time that the log entry was created.

## 101.6 Mapping of Events

Implementations of a Log Service must log Framework-generated events and map the information to `LogEntry` objects in a consistent way. Framework events must be treated exactly the same as other logged events and distributed to all `LogListener` objects that are associated with the Log Reader Service. The following sections define the mapping for the three different event types: `Bundle`, `Service`, and `Framework`.

### 101.6.1 Bundle Events Mapping

A `Bundle` Event is mapped to a `LogEntry` object according to the following table.

Table 101.2

*Mapping of Bundle Events to Log Entries*

Log Entry method	Information about Bundle Event
<code>getLevel()</code>	<code>LOG_INFO</code>
<code>getBundle()</code>	Identifies the bundle to which the event happened. In other words, it identifies the bundle that was installed, started, stopped, updated, or uninstalled. This identification is obtained by calling <code>getBundle()</code> on the <code>BundleEvent</code> object.
<code>getException()</code>	null
<code>getServiceReference()</code>	null



Log Entry method	Information about Bundle Event
getMessage()	The message depends on the event type: <ul style="list-style-type: none"> <li>• INSTALLED - "BundleEvent INSTALLED"</li> <li>• STARTED - "BundleEvent STARTED"</li> <li>• STOPPED - "BundleEvent STOPPED"</li> <li>• UPDATED - "BundleEvent UPDATED"</li> <li>• UNINSTALLED - "BundleEvent UNINSTALLED"</li> <li>• RESOLVED - "BundleEvent RESOLVED"</li> <li>• UNRESOLVED - "BundleEvent UNRESOLVED"</li> </ul>

## 101.6.2 Service Events Mapping

A Service Event is mapped to a LogEntry object according to the following table.

Table 101.3 Mapping of Service Events to Log Entries

Log Entry method	Information about Service Event
getLevel()	LOG_INFO, except for the ServiceEvent.MODIFIED event. This event can happen frequently and contains relatively little information. It must be logged with a level of LOG_DEBUG.
getBundle()	Identifies the bundle that registered the service associated with this event. It is obtained by calling getServiceReference().getBundle() on the ServiceEvent object.
getException()	null
getServiceReference()	Identifies a reference to the service associated with the event. It is obtained by calling getServiceReference() on the ServiceEvent object.
getMessage()	This message depends on the actual event type. The messages are mapped as follows: <ul style="list-style-type: none"> <li>• REGISTERED - "ServiceEvent REGISTERED"</li> <li>• MODIFIED - "ServiceEvent MODIFIED"</li> <li>• UNREGISTERING - "ServiceEvent UNREGISTERING"</li> </ul>

## 101.6.3 Framework Events Mapping

A Framework Event is mapped to a LogEntry object according to the following table.

Table 101.4 Mapping of Framework Event to Log Entries

Log Entry method	Information about Framework Event
getLevel()	LOG_INFO, except for the FrameworkEvent.ERROR event. This event represents an error and is logged with a level of LOG_ERROR.
getBundle()	Identifies the bundle associated with the event. This may be the system bundle. It is obtained by calling getBundle() on the FrameworkEvent object.
getException()	Identifies the exception associated with the error. This will be null for event types other than ERROR. It is obtained by calling getThrowable() on the FrameworkEvent object.
getServiceReference()	null

Log Entry method	Information about Framework Event
getMessage()	<p>This message depends on the actual event type. The messages are mapped as follows:</p> <ul style="list-style-type: none"> <li>• STARTED - "FrameworkEvent STARTED"</li> <li>• ERROR - "FrameworkEvent ERROR"</li> <li>• PACKAGES_REFRESHED - "FrameworkEvent PACKAGES REFRESHED"</li> <li>• STARTLEVEL_CHANGED - "FrameworkEvent STARTLEVEL CHANGED"</li> <li>• WARNING - "FrameworkEvent WARNING"</li> <li>• INFO - "FrameworkEvent INFO"</li> </ul>

#### 101.6.4 Log Events

Log events must be delivered by the Log Service implementation to the Event Admin service (if present) asynchronously under the topic:

`org.osgi/service/log/LogEntry/<event type>`

The logging level is used as event type:

```
LOG_ERROR
LOG_WARNING
LOG_INFO
LOG_DEBUG
LOG_OTHER (when event is not recognized)
```

The properties of a log event are:

- `bundle.id` - (Long) The source bundle's id.
- `bundle.symbolicName` - (String) The source bundle's symbolic name. Only set if not null.
- `bundle` - (Bundle) The source bundle.
- `log.level` - (Integer) The log level.
- `message` - (String) The log message.
- `timestamp` - (Long) The log entry's timestamp.
- `log.entry` - (LogEntry) The LogEntry object.

If the log entry has an associated Exception:

- `exception.class` - (String) The fully-qualified class name of the attached exception. Only set if the `getException` method returns a non-null value.
- `exception.message` - (String) The message of the attached Exception. Only set if the Exception message is not null.
- `exception` - (Throwable) The Exception returned by the `getException` method.

If the `getServiceReference` method returns a non- null value:

- `service` - (ServiceReference) The result of the `getServiceReference` method.
- `service.id` - (Long) The id of the service.
- `service.pid` - (String) The service's persistent identity. Only set if the `service.pid` service property is not null.
- `service.objectClass` - (String[]) The object class of the service object.

## 101.7 Security

The Log Service should only be implemented by trusted bundles. This bundle requires `ServicePermission[LogService|LogReaderService, REGISTER]`. Virtually all bundles should get `ServicePermission[LogService, GET]`. The `ServicePermission[LogReaderService, GET]` should only be assigned to trusted bundles.

## 101.8 org.osgi.service.log

Log Service Package Version 1.3.

Bundles wishing to use this package must list the package in the Import-Package header of the bundle's manifest. This package has two types of users: the consumers that use the API in this package and the providers that implement the API in this package.

Example import for consumers using the API in this package:

```
Import-Package: org.osgi.service.log; version="[1.3,2.0]"
```

Example import for providers implementing the API in this package:

```
Import-Package: org.osgi.service.log; version="[1.3,1.4]"
```

### 101.8.1 Summary

- `LogEntry` - Provides methods to access the information contained in an individual Log Service log entry.
- `LogListener` - Subscribes to `LogEntry` objects from the `LogReaderService`.
- `LogReaderService` - Provides methods to retrieve `LogEntry` objects from the log.
- `LogService` - Provides methods for bundles to write messages to the log.

### 101.8.2 public interface LogEntry

Provides methods to access the information contained in an individual Log Service log entry.

A `LogEntry` object may be acquired from the `LogReaderService.getLog` method or by registering a `LogListener` object.

*See Also* `LogReaderService.getLog`, `LogListener`

*Concurrency* Thread-safe

*No Implement* Consumers of this API must not implement this interface

#### 101.8.2.1 public Bundle getBundle()

- Returns the bundle that created this `LogEntry` object.

*Returns* The bundle that created this `LogEntry` object; null if no bundle is associated with this `LogEntry` object.

#### 101.8.2.2 public Throwable getException()

- Returns the exception object associated with this `LogEntry` object.

In some implementations, the returned exception may not be the original exception. To avoid references to a bundle defined exception class, thus preventing an uninstalled bundle from being garbage collected, the Log Service may return an exception object of an implementation defined `Throwable` subclass. The returned object will attempt to provide as much information as possible from the original exception object such as the message and stack trace.

*Returns* Throwable object of the exception associated with this LogEntry; null if no exception is associated with this LogEntry object.

#### 101.8.2.3 **public int getLevel()**

- Returns the severity level of this LogEntry object.

This is one of the severity levels defined by the LogService interface.

*Returns* Severity level of this LogEntry object.

*See Also* LogService.LOG\_ERROR, LogService.LOG\_WARNING, LogService.LOG\_INFO, LogService.LOG\_DEBUG

#### 101.8.2.4 **public String getMessage()**

- Returns the human readable message associated with this LogEntry object.

*Returns* String containing the message associated with this LogEntry object.

#### 101.8.2.5 **public ServiceReference getServiceReference()**

- Returns the ServiceReference object for the service associated with this LogEntry object.

*Returns* ServiceReference object for the service associated with this LogEntry object; null if no ServiceReference object was provided.

#### 101.8.2.6 **public long getTime()**

- Returns the value of currentTimeMillis() at the time this LogEntry object was created.

*Returns* The system time in milliseconds when this LogEntry object was created.

*See Also* System.currentTimeMillis()

### 101.8.3 **public interface LogListener extends EventListener**

Subscribes to LogEntry objects from the LogReaderService.

A LogListener object may be registered with the Log Reader Service using the LogReaderService.addListener method. After the listener is registered, the logged method will be called for each LogEntry object created. The LogListener object may be unregistered by calling the LogReaderService.removeLogListener method.

*See Also* LogReaderService, LogEntry, LogReaderService.addListener(LogListener), LogReaderService.removeLogListener(LogListener)

*Concurrency* Thread-safe

#### 101.8.3.1 **public void logged(LogEntry entry)**

*entry* A LogEntry object containing log information.

- Listener method called for each LogEntry object created.

As with all event listeners, this method should return to its caller as soon as possible.

*See Also* LogEntry

### 101.8.4 **public interface LogReaderService**

Provides methods to retrieve LogEntry objects from the log.

There are two ways to retrieve LogEntry objects:

- The primary way to retrieve LogEntry objects is to register a LogListener object whose LogListener.logged method will be called for each entry added to the log.

- To retrieve past LogEntry objects, the getLog method can be called which will return an Enumeration of all LogEntry objects in the log.

*See Also* LogEntry, LogListener, LogListener.logged(LogEntry)

*Concurrency* Thread-safe

#### **101.8.4.1 public void addLogListener(LogListener listener)**

*listener* A LogListener object to register; the LogListener object is used to receive LogEntry objects.

- Subscribes to LogEntry objects.

This method registers a LogListener object with the Log Reader Service. The LogListener.logged(LogEntry) method will be called for each LogEntry object placed into the log.

When a bundle which registers a LogListener object is stopped or otherwise releases the Log Reader Service, the Log Reader Service must remove all of the bundle's listeners.

If this Log Reader Service's list of listeners already contains a listener *l* such that (*l*==*listener*), this method does nothing.

*See Also* LogListener, LogEntry, LogListener.logged(LogEntry)

#### **101.8.4.2 public Enumeration getLog()**

- Returns an Enumeration of all LogEntry objects in the log.

Each element of the enumeration is a LogEntry object, ordered with the most recent entry first.

Whether the enumeration is of all LogEntry objects since the Log Service was started or some recent past is implementation-specific. Also implementation-specific is whether informational and debug LogEntry objects are included in the enumeration.

*Returns* An Enumeration of all LogEntry objects in the log.

#### **101.8.4.3 public void removeLogListener(LogListener listener)**

*listener* A LogListener object to unregister.

- Unsubscribes to LogEntry objects.

This method unregisters a LogListener object from the Log Reader Service.

If *listener* is not contained in this Log Reader Service's list of listeners, this method does nothing.

*See Also* LogListener

### **101.8.5 public interface LogService**

Provides methods for bundles to write messages to the log.

LogService methods are provided to log messages; optionally with a ServiceReference object or an exception.

Bundles must log messages in the OSGi environment with a severity level according to the following hierarchy:

1. LOG\_ERROR
2. LOG\_WARNING
3. LOG\_INFO
4. LOG\_DEBUG

*Concurrency* Thread-safe

*No Implement* Consumers of this API must not implement this interface

**101.8.5.1      public static final int LOG\_DEBUG = 4**

A debugging message (Value 4).

This log entry is used for problem determination and may be irrelevant to anyone but the bundle developer.

**101.8.5.2      public static final int LOG\_ERROR = 1**

An error message (Value 1).

This log entry indicates the bundle or service may not be functional.

**101.8.5.3      public static final int LOG\_INFO = 3**

An informational message (Value 3).

This log entry may be the result of any change in the bundle or service and does not indicate a problem.

**101.8.5.4      public static final int LOG\_WARNING = 2**

A warning message (Value 2).

This log entry indicates a bundle or service is still functioning but may experience problems in the future because of the warning condition.

**101.8.5.5      public void log(int level,String message)**

*level* The severity of the message. This should be one of the defined log levels but may be any integer that is interpreted in a user defined way.

*message* Human readable string describing the condition or null.

- Logs a message.

The ServiceReference field and the Throwable field of the LogEntry object will be set to null.

*See Also* LOG\_ERROR, LOG\_WARNING, LOG\_INFO, LOG\_DEBUG

**101.8.5.6      public void log(int level,String message,Throwable exception)**

*level* The severity of the message. This should be one of the defined log levels but may be any integer that is interpreted in a user defined way.

*message* The human readable string describing the condition or null.

*exception* The exception that reflects the condition or null.

- Logs a message with an exception.

The ServiceReference field of the LogEntry object will be set to null.

*See Also* LOG\_ERROR, LOG\_WARNING, LOG\_INFO, LOG\_DEBUG

**101.8.5.7      public void log(ServiceReference sr,int level,String message)**

*sr* The ServiceReference object of the service that this message is associated with or null.

*level* The severity of the message. This should be one of the defined log levels but may be any integer that is interpreted in a user defined way.

*message* Human readable string describing the condition or null.

- Logs a message associated with a specific ServiceReference object.

The Throwable field of the LogEntry will be set to null.

*See Also* LOG\_ERROR, LOG\_WARNING, LOG\_INFO, LOG\_DEBUG

**101.8.5.8      public void log(ServiceReference sr,int level,String message,Throwable exception)**

*sr* The ServiceReference object of the service that this message is associated with.

*level* The severity of the message. This should be one of the defined log levels but may be any integer that is interpreted in a user defined way.

*message* Human readable string describing the condition or null.

*exception* The exception that reflects the condition or null.

- Logs a message with an exception associated and a ServiceReference object.

*See Also* LOG\_ERROR, LOG\_WARNING, LOG\_INFO, LOG\_DEBUG





# 102 Http Service Specification

## Version 1.2

### 102.1 Introduction

An OSGi framework normally provides users with access to services on the Internet and other networks. This access allows users to remotely retrieve information from, and send control to, services in an OSGi framework using a standard web browser.

Bundle developers typically need to develop communication and user interface solutions for standard technologies such as HTTP, HTML, XML, and servlets.

The Http Service supports two standard techniques for this purpose:

- *Registering servlets* - A servlet is a Java object which implements the Java Servlet API. Registering a servlet in the Framework gives it control over some part of the Http Service URI name-space.
- *Registering resources* - Registering a resource allows HTML files, image files, and other static resources to be made visible in the Http Service URI name-space by the requesting bundle.

Implementations of the Http Service can be based on:

- [1] *HTTP 1.0 Specification RFC-1945*
- [2] *HTTP 1.1 Specification RFC-2616*

Alternatively, implementations of this service can support other protocols if these protocols can conform to the semantics of the `javax.servlet` API. This additional support is necessary because the Http Service is closely related to [3] *Java Servlet Technology*. Http Service implementations must support at least version 2.1 of the Java Servlet API.

#### 102.1.1 Entities

This specification defines the following interfaces which a bundle developer can implement collectively as an Http Service or use individually:

- [\*HttpContext\*](#) - Allows bundles to provide information for a servlet or resource registration.
- [\*HttpService\*](#) - Allows other bundles in the Framework to dynamically register and unregister resources and servlets into the Http Service URI name-space.
- [\*NamespaceException\*](#) - Is thrown to indicate an error with the caller's request to register a servlet or resource into the Http Service URI name-space.

Figure 102.1 Http Service Overview Diagram

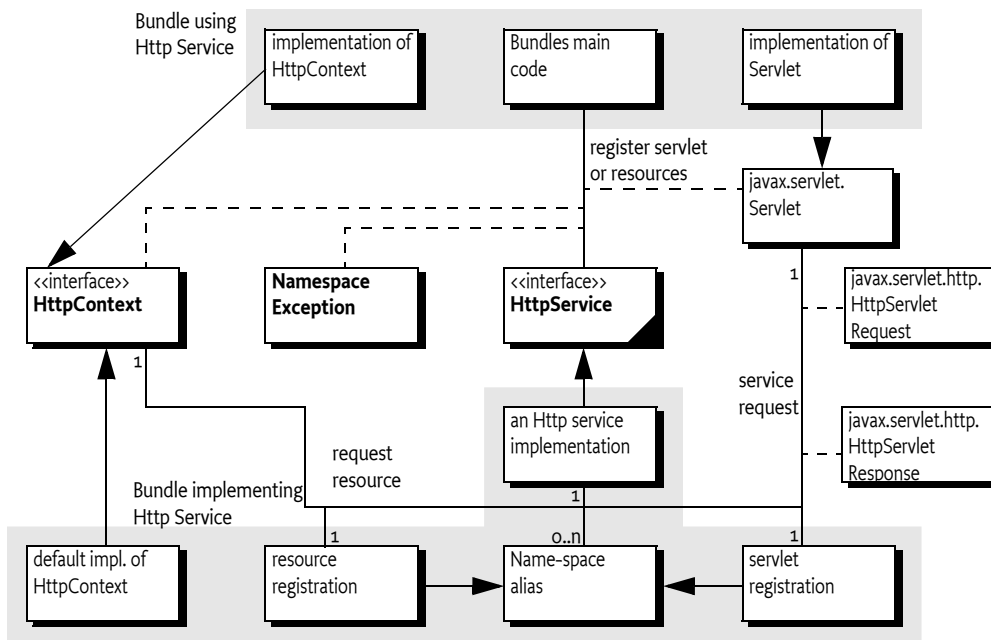

## 102.2 Registering Servlets

`javax.servlet.Servlet` objects can be registered with the Http Service by using the `HttpService` interface. For this purpose, the `HttpService` interface defines the method `registerServlet(String, javax.servlet.Servlet, Dictionary, HttpContext)`.

For example, if the Http Service implementation is listening to port 80 on the machine `www.acme.com` and the Servlet object is registered with the name `"/servlet"`, then the Servlet object's service method is called when the following URL is used from a web browser:

```
http://www.acme.com/servlet?name=bugs
```

All Servlet objects and resource registrations share the same name-space. If an attempt is made to register a resource or Servlet object under the same name as a currently registered resource or Servlet object, a `NamespaceException` is thrown. See *Mapping HTTP Requests to Servlet and Resource Registrations* on page 49 for more information about the handling of the Http Service name-space.

Each Servlet registration must be accompanied with an `HttpContext` object. This object provides the handling of resources, media typing, and a method to handle authentication of remote requests. See *Authentication* on page 52.

For convenience, a default `HttpContext` object is provided by the Http Service and can be obtained with `createDefaultHttpContext()`. Passing a null parameter to the registration method achieves the same effect.

Servlet objects require a `ServletContext` object. This object provides a number of functions to access the Http Service Java Servlet environment. It is created by the implementation of the Http Service for each unique `HttpContext` object with which a Servlet object is registered. Thus, Servlet objects registered with the same `HttpContext` object must also share the same `ServletContext` object.

Servlet objects are initialized by the Http Service when they are registered and bound to that specific Http Service. The initialization is done by calling the Servlet object's `Servlet.init(ServletConfig)` method. The `ServletConfig` parameter provides access to the initialization parameters specified when the Servlet object was registered.

Therefore, the same Servlet instance must not be reused for registration with another Http Service, nor can it be registered under multiple names. Unique instances are required for each registration.

The following example code demonstrates the use of the `registerServlet` method:

```
Hashtable initparams = new Hashtable();
initparams.put( "name", "value" );

Servlet myServlet = new HttpServlet() {
    String name = "<not set>";

    public void init( ServletConfig config ) {
        this.name = (String)
            config.getInitParameter( "name" );
    }

    public void doGet(
        HttpServletRequest req,
        HttpServletResponse rsp
    ) throws IOException {
        rsp.setContentType( "text/plain" );
        req.getWriter().println( this.name );
    }
};

getHttpService().registerServlet(
    "/servletAlias",
    myServlet,
    initparams,
    null // use default context
);
// myServlet has been registered
// and its init method has been called. Remote
// requests are now handled and forwarded to
// the servlet.
...
getHttpService().unregister("/servletAlias");
// myServlet has been unregistered and its
// destroy method has been called
```

This example registers the servlet, `myServlet`, at alias: `/servletAlias`. Future requests for `http://www.acme.com/servletAlias` maps to the servlet, `myServlet`, whose service method is called to process the request. (The service method is called in the `HttpServlet` base class and dispatched to a `doGet`, `doPut`, `doPost`, `doOptions`, `doTrace`, or `doDelete` call depending on the HTTP request method used.)

## 102.3 Registering Resources

A resource is a file containing images, static HTML pages, sounds, movies, applets, etc. Resources do not require any handling from the bundle. They are transferred directly from their source - usually the JAR file that contains the code for the bundle - to the requester using HTTP.

Resources could be handled by Servlet objects as explained in *Registering Servlets* on page 46. Transferring a resource over HTTP, however, would require very similar Servlet objects for each bundle. To prevent this redundancy, resources can be registered directly with the Http Service via the [HttpService](#) interface. This HttpService interface defines the `registerResources(String,String,HttpContext)` method for registering a resource into the Http Service URI name-space.

The first parameter is the external alias under which the resource is registered with the Http Service. The second parameter is an internal prefix to map this resource to the bundle's name-space. When a request is received, the HttpService object must remove the external alias from the URI, replace it with the internal prefix, and call the `getResource(String)` method with this new name on the associated HttpContext object. The HttpContext object is further used to get the MIME type of the resource and to authenticate the request.

Resources are returned as a `java.net.URL` object. The Http Service must read from this URL object and transfer the content to the initiator of the HTTP request.

This return type was chosen because it matches the return type of the `java.lang.Class.getResource(String resource)` method. This method can retrieve resources directly from the same place as the one from which the class was loaded - often a package directory in the JAR file of the bundle. This method makes it very convenient to retrieve resources from the bundle that are contained in the package.

The following example code demonstrates the use of the `registerResources` method:

```
package com.acme;
...
HttpContext context = new HttpContext() {
    public boolean handleSecurity(
        HttpServletRequest request,
        HttpServletResponse response
    ) throws IOException {
        return true;
    }

    public URL getResource(String name) {
        return getClass().getResource(name);
    }

    public String getMimeType(String name) {
        return null;
    }
};

getHttpService().registerResources (
    "/files",
    "www",
    context
);
...
```

```
getHttpService().unregister("/files");
```

This example registers the alias `/files` on the Http Service. Requests for resources below this namespace are transferred to the `HttpContext` object with an internal name of `www/<name>`. This example uses the `Class.getResource(String)` method. Because the internal name does not start with a `/`, it must map to a resource in the `"com/acme/www"` directory of the JAR file. If the internal name did start with a `/`, the package name would not have to be prefixed and the JAR file would be searched from the root. Consult the `java.lang.Class.getResource(String)` method for more information.

In the example, a request for `http://www.acme.com/files/myfile.html` must map to the name `"com/acme/www/myfile.html"` which is in the bundle's JAR file.

More sophisticated implementations of the `getResource(String)` method could filter the input name, restricting the resources that may be returned or map the input name onto the file system (if the security implications of this action are acceptable).

Alternatively, the resource registration could have used a default `HttpContext` object, as demonstrated in the following call to `registerResources`:

```
getHttpService().registerResources(  
    "/files",  
    "/com/acme/www",  
    null  
);
```

In this case, the Http Service implementation would call the `createDefaultHttpContext()` method and use its return value as the `HttpContext` argument for the `registerResources` method. The default implementation must map the resource request to the bundle's resource, using `Bundle.getResource(String)`. In the case of the previous example, however, the internal name must now specify the full path to the directory containing the resource files in the JAR file. No automatic prefixing of the package name is done.

The `getMimeType(String)` implementation of the default `HttpContext` object should rely on the default mapping provided by the Http Service by returning `null`. Its `handleSecurity(HttpServletRequest, HttpServletResponse)` may implement an authentication mechanism that is implementation-dependent.

## 102.4 Mapping HTTP Requests to Servlet and Resource Registrations

When an HTTP request comes in from a client, the Http Service checks to see if the requested URI matches any registered aliases. A URI matches only if the path part of the URI is exactly the same string. Matching is case sensitive.

If it does match, a matching registration takes place, which is processed as follows:

1. If the registration corresponds to a servlet, the authorization is verified by calling the `handleSecurity` method of the associated `HttpContext` object. See *Authentication* on page 52. If the request is authorized, the servlet must be called by its service method to complete the HTTP request.
2. If the registration corresponds to a resource, the authorization is verified by calling the `handleSecurity` method of the associated `HttpContext` object. See *Authentication* on page 52. If the request is authorized, a target resource name is constructed from the requested URI by substituting the alias from the registration with the internal name from the registration if the alias is not `/`. If the alias is `/`, then the target resource name is constructed by prefixing the request-

- ed URI with the internal name. An internal name of "/" is considered to have the value of the empty string ("") during this process.
3. The target resource name must be passed to the `getResource` method of the associated `HttpContext` object.
  4. If the returned URL object is not null, the Http Service must return the contents of the URL to the client completing the HTTP request. The translated target name, as opposed to the original requested URI, must also be used as the argument to `HttpContext.getMimeType`.
  5. If the returned URL object is null, the Http Service continues as if there was no match.
  6. If there is no match, the Http Service must attempt to match sub-strings of the requested URI to registered aliases. The sub-strings of the requested URI are selected by removing the last "/" and everything to the right of the last "/".

The Http Service must repeat this process until either a match is found or the sub-string is an empty string. If the sub-string is empty and the alias "/" is registered, the request is considered to match the alias "/". Otherwise, the Http Service must return `HttpServletResponse.SC_NOT_FOUND(404)` to the client.

For example, an HTTP request comes in with a request URI of `/fudd/bugs/foo.txt`, and the only registered alias is `/fudd`. A search for `/fudd/bugs/foo.txt` will not match an alias. Therefore, the Http Service will search for the alias `/fudd/bugs` and the alias `/fudd`. The latter search will result in a match and the matched alias registration must be used.

Registrations for identical aliases are not allowed. If a bundle registers the alias `/fudd`, and another bundle tries to register the exactly the same alias, the second caller must receive a `NamespaceException` and its resource or servlet must *not* be registered. It could, however, register a similar alias - for example, `/fudd/bugs`, as long as no other registration for this alias already exists.

The following table shows some examples of the usage of the name-space.

Table 102.1

*Examples of Name-space Mapping*

Alias	Internal Name	URI	<code>getResource</code> Parameter
/	(empty string)	<code>/fudd/bugs</code>	<code>/fudd/bugs</code>
/	/	<code>/fudd/bugs</code>	<code>/fudd/bugs</code>
/	<code>/tmp</code>	<code>/fudd/bugs</code>	<code>/tmp/fudd/bugs</code>
<code>/fudd</code>	(empty string)	<code>/fudd/bugs</code>	<code>/bugs</code>
<code>/fudd</code>	/	<code>/fudd/bugs</code>	<code>/bugs</code>
<code>/fudd</code>	<code>/tmp</code>	<code>/fudd/bugs</code>	<code>/tmp/bugs</code>
<code>/fudd</code>	<code>tmp</code>	<code>/fudd/bugs/x.gif</code>	<code>tmp/bugs/x.gif</code>
<code>/fudd/bugs/x.gif</code>	<code>tmp/y.gif</code>	<code>/fudd/bugs/x.gif</code>	<code>tmp/y.gif</code>

## 102.5 The Default Http Context Object

The `HttpContext` object in the first example demonstrates simple implementations of the `HttpContext` interface methods. Alternatively, the example could have used a default `HttpContext` object, as demonstrated in the following call to `registerServlet`:

```
getHttpService().registerServlet(
    "/servletAlias",
    myServlet,
    initparams,
    null
);
```

In this case, the Http Service implementation must call `createDefault HttpContext` and use the return value as the `HttpContext` argument.

If the default `HttpContext` object, and thus the `ServletContext` object, is to be shared by multiple servlet registrations, the previous servlet registration example code needs to be changed to use the same default `HttpContext` object. This change is demonstrated in the next example:

```
HttpContext defaultContext =
    getHttpService().createDefaultHttpContext();

getHttpService().registerServlet(
    "/servletAlias",
    myServlet,
    initparams,
    defaultContext
);

// defaultContext can be reused
// for further servlet registrations
```

## 102.6 Multipurpose Internet Mail Extension (MIME) Types

MIME defines an extensive set of headers and procedures to encode binary messages in US-ASCII mails. For an overview of all the related RFCs, consult [4] *MIME Multipurpose Internet Mail Extension*.

An important aspect of this extension is the type (file format) mechanism of the binary messages. The type is defined by a string containing a general category (text, application, image, audio and video, multipart, and message) followed by a "/" and a specific media type, as in the example, "text/html" for HTML formatted text files. A MIME type string can be followed by additional specifiers by separating key=value pairs with a semicolon (';' \u003B). These specifiers can be used, for example, to define character sets as follows:

```
text/plain ; charset=iso-8859-1
```

The Internet Assigned Number Authority (IANA) maintains a set of defined MIME media types. This list can be found at [5] *Assigned MIME Media Types*. MIME media types are extendable, and when any part of the type starts with the prefix "x-", it is assumed to be vendor-specific and can be used for testing. New types can be registered as described in [6] *Registration Procedures for new MIME media types*.

HTTP bases its media typing on the MIME RFCs. The "Content-Type" header should contain a MIME media type so that the browser can recognize the type and format the content correctly.

The source of the data must define the MIME media type for each transfer. Most operating systems do not support types for files, but use conventions based on file names, such as the last part of the file name after the last ".". This extension is then mapped to a media type.

Implementations of the Http Service should have a reasonable default of mapping common extensions to media types based on file extensions.

Table 102.2 Sample Extension to MIME Media Mapping

Extension	MIME media type	Description
.jpg .jpeg	image/jpeg	JPEG Files
.gif	image/gif	GIF Files
.css	text/css	Cascading Style Sheet Files
.txt	text/plain	Text Files

Extension	MIME media type	Description
.wml	text/vnd.wap.wml	Wireless Access Protocol (WAP) Mark Language
.htm .html	text/html	Hyper Text Markup Language
.wbmp	image/vnd.wap.wbmp	Bitmaps for WAP

Only the bundle developer, however, knows exactly which files have what media type. The `HttpContext` interface can therefore be used to map this knowledge to the media type. The `HttpContext` class has the following method for this: `getMimeType(String)`.

The implementation of this method should inspect the file name and use its internal knowledge to map this name to a MIME media type.

Simple implementations can extract the extension and look up this extension in a table.

Returning null from this method allows the Http Service implementation to use its default mapping mechanism.

## 102.7 Authentication

The Http Service has separated the authentication and authorization of a request from the execution of the request. This separation allows bundles to use available `Servlet` sub-classes while still providing bundle specific authentication and authorization of the requests.

Prior to servicing each incoming request, the Http Service calls the `handleSecurity(javax.servlet.http.HttpServletRequest, javax.servlet.http.HttpServletResponse)` method on the `HttpContext` object that is associated with the request URI. This method controls whether the request is processed in the normal manner or an authentication error is returned.

If an implementation wants to authenticate the request, it can use the authentication mechanisms of HTTP. See [7] *RFC 2617: HTTP Authentication: Basic and Digest Access Authentication*. These mechanisms normally interpret the headers and decide if the user identity is available, and if it is, whether that user has authenticated itself correctly.

There are many different ways of authenticating users, and the `handleSecurity` method on the `HttpContext` object can use whatever method it requires. If the method returns `true`, the request must continue to be processed using the potentially modified `HttpServletRequest` and `HttpServletResponse` objects. If the method returns `false`, the request must *not* be processed.

A common standard for HTTP is the basic authentication scheme that is not secure when used with HTTP. Basic authentication passes the password in base 64 encoded strings that are trivial to decode into clear text. Secure transport protocols like HTTPS use SSL to hide this information. With these protocols basic authentication is secure.

Using basic authentication requires the following steps:

1. If no `Authorization` header is set in the request, the method should set the `WWW-Authenticate` header in the response. This header indicates the desired authentication mechanism and the realm. For example, `WWW-Authenticate: Basic realm="ACME"`.

The header should be set with the response object that is given as a parameter to the `handleSecurity` method. The `handleSecurity` method should set the status to `HttpServletResponse.SC_UNAUTHORIZED (401)` and return `false`.

2. Secure connections can be verified with the `ServletRequest.getScheme()` method. This method returns, for example, "https" for an SSL connection; the `handleSecurity` method can use this and other information to decide if the connection's security level is acceptable. If not, the `handleSecurity` method should set the status to `HttpServletResponse.SC_FORBIDDEN (403)` and return `false`.



3. Next, the request must be authenticated. When basic authentication is used, the Authorization header is available in the request and should be parsed to find the user and password. See [7] *RFC 2617: HTTP Authentication: Basic and Digest Access Authentication* for more information.

If the user cannot be authenticated, the status of the response object should be set to `HttpServletResponse.SC_UNAUTHORIZED` (401) and return false.

4. The authentication mechanism that is actually used and the identity of the authenticated user can be of interest to the Servlet object. Therefore, the implementation of the `handleSecurity` method should set this information in the request object using the `ServletRequest.setAttribute` method. This specification has defined a number of OSGi-specific attribute names for this purpose:
  - **AUTHENTICATION\_TYPE** - Specifies the scheme used in authentication. A Servlet may retrieve the value of this attribute by calling the `HttpServletRequest.getAuthType` method. This attribute name is `org.osgi.service.http.authentication.type`.
  - **REMOTE\_USER** - Specifies the name of the authenticated user. A Servlet may retrieve the value of this attribute by calling the `HttpServletRequest.getRemoteUser` method. This attribute name is `org.osgi.service.http.authentication.remote.user`.
  - **AUTHORIZATION** - If a User Admin service is available in the environment, then the `handleSecurity` method should set this attribute with the Authorization object obtained from the User Admin service. Such an object encapsulates the authentication of its remote user. A Servlet may retrieve the value of this attribute by calling `ServletRequest.getAttribute(HttpContext.AUTHORIZATION)`. This header name is `org.osgi.service.useradmin.authorization`.
5. Once the request is authenticated and any attributes are set, the `handleSecurity` method should return true. This return indicates to the Http Service that the request is authorized and processing may continue. If the request is for a Servlet, the Http Service must then call the service method on the Servlet object.

## 102.8 Security

This section only applies when executing in an OSGi environment which is enforcing Java permissions.

### 102.8.1 Accessing Resources with the Default Http Context

The Http Service must be granted `AdminPermission[* ,RESOURCE]` so that bundles may use a default `HttpContext` object. This is necessary because the implementation of the default `HttpContext` object must call `Bundle.getResource` to access the resources of a bundle and this method requires the caller to have `AdminPermission[bundle,RESOURCE]`.

Any bundle may access resources in its own bundle by calling `Class.getResource`. This operation is privileged. The resulting URL object may then be passed to the Http Service as the result of a `HttpContext.getResource` call. No further permission checks are performed when accessing bundle resource URL objects, so the Http Service does not need to be granted any additional permissions.

### 102.8.2 Accessing Other Types of Resources

In order to access resources that were not registered using the default `HttpContext` object, the Http Service must be granted sufficient privileges to access these resources. For example, if the `getResource` method of the registered `HttpContext` object returns a file URL, the Http Service requires the corresponding `FilePermission` to read the file. Similarly, if the `getResource` method of the registered `HttpContext` object returns an HTTP URL, the Http Service requires the corresponding `SocketPermission` to connect to the resource.

Therefore, in most cases, the Http Service should be a privileged service that is granted sufficient permission to serve any bundle's resources, no matter where these resources are located. Therefore, the Http Service must capture the `AccessControlContext` object of the bundle registering resources or a servlet, and then use the captured `AccessControlContext` object when accessing resources returned by the registered `HttpContext` object. This situation prevents a bundle from registering resources that it does not have permission to access.

Therefore, the Http Service should follow a scheme like the following example. When a resource or servlet is registered, it should capture the context.

```
AccessControlContext acc =
    AccessController.getContext();
```

When a URL returned by the `getResource` method of the associated `HttpContext` object is called, the Http Service must call the `getResource` method in a `doPrivileged` construct using the `AccessControlContext` object of the registering bundle:

```
AccessController.doPrivileged(
    new PrivilegedExceptionAction() {
        public Object run() throws Exception {
            ...
        }
    }, acc);
```

The Http Service must only use the captured `AccessControlContext` when accessing resource URL objects.

### 102.8.3 Servlet and HttpContext objects

This specification does not require that the Http Service is granted All Permission or wraps calls to the Servlet and Http Context objects in a `doPrivileged` block. Therefore, it is the responsibility of the Servlet and Http Context implementations to use a `doPrivileged` block when performing privileged operations.

## 102.9 Configuration Properties

If the Http Service does not have its port values configured through some other means, the Http Service implementation should use the following properties to determine the port values upon which to listen.

The following OSGi environment properties are used to specify default HTTP ports:

- `org.osgi.service.http.port` - This property specifies the port used for servlets and resources accessible via HTTP. The default value for this property is 80.
- `org.osgi.service.http.port.secure` - This property specifies the port used for servlets and resources accessible via HTTPS. The default value for this property is 443.

### 102.10 org.osgi.service.http

Http Service Package Version 1.2.

Bundles wishing to use this package must list the package in the `Import-Package` header of the bundle's manifest. This package has two types of users: the consumers that use the API in this package and the providers that implement the API in this package.

Example import for consumers using the API in this package:

```
Import-Package: org.osgi.service.http; version="[1.2,2.0)"
```

Example import for providers implementing the API in this package:

```
Import-Package: org.osgi.service.http; version="[1.2,1.3)"
```

### 102.10.1 Summary

- `HttpContext` - Context for HTTP Requests.
- `HttpService` - The Http Service allows other bundles in the OSGi environment to dynamically register resources and servlets into the URI namespace of Http Service.
- `NamespaceException` - A `NamespaceException` is thrown to indicate an error with the caller's request to register a servlet or resources into the URI namespace of the Http Service.

### 102.10.2 public interface `HttpContext`

Context for HTTP Requests.

This service defines methods that the Http Service may call to get information for a request.

Servlets may be associated with an `HttpContext` service. Servlets that are associated using the same `HttpContext` object will share the same `ServletContext` object.

If no `HttpContext` service is associated, a default `HttpContext` is used. The behavior of the methods on the default `HttpContext` is defined as follows:

- `getMimeType` - Does not define any customized MIME types for the Content-Type header in the response, and always returns null.
- `handleSecurity` - Performs implementation-defined authentication on the request.
- `getResource` - Assumes the named resource is in the bundle of the servlet service. This method calls the servlet bundle's `Bundle.getResource` method, and returns the appropriate URL to access the resource. On a Java runtime environment that supports permissions, the Http Service needs to be granted `org.osgi.framework.AdminPermission[*],RESOURCE]`.

#### 102.10.2.1 public static final String AUTHENTICATION\_TYPE = "org.osgi.service.http.authentication.type"

`HttpServletRequest` attribute specifying the scheme used in authentication. The value of the attribute can be retrieved by `HttpServletRequest.getAuthType`. This attribute name is `org.osgi.service.http.authentication.type`.

Since 1.1

#### 102.10.2.2 public static final String AUTHORIZATION = "org.osgi.service.useradmin.authorization"

`HttpServletRequest` attribute specifying the Authorization object obtained from the `org.osgi.service.useradmin.UserAdmin` service. The value of the attribute can be retrieved by `HttpServletRequest.getAttribute(HttpContext.AUTHORIZATION)`. This attribute name is `org.osgi.service.useradmin.authorization`.

Since 1.1

#### 102.10.2.3 public static final String REMOTE\_USER = "org.osgi.service.http.authentication.remote.user"

`HttpServletRequest` attribute specifying the name of the authenticated user. The value of the attribute can be retrieved by `HttpServletRequest.getRemoteUser`. This attribute name is `org.osgi.service.http.authentication.remote.user`.

Since 1.1

#### 102.10.2.4 public String getMimeType(String name)

*name* The name for which to determine the MIME type.

- Maps a name to a MIME type.

Called by the Http Service to determine the MIME type for the specified name. For servlets, the Http Service will call this method to support the ServletContext method `getMimeType`. For resources, the Http Service will call this method to determine the MIME type for the Content-Type header in the response.

*Returns* The MIME type (e.g. `text/html`) of the specified name or null to indicate that the Http Service should determine the MIME type itself.

#### 102.10.2.5 **public URL getResource(String name)**

*name* the name of the requested resource

- Maps a resource name to a URL.

Called by the Http Service to map a resource name to a URL. For servlet registrations, Http Service will call this method to support the ServletContext methods `getResource` and `getResourceAsStream`. For resource registrations, Http Service will call this method to locate the named resource. The context can control from where resources come. For example, the resource can be mapped to a file in the bundle's persistent storage area via `bundleContext.getDataFile(name).toURL()` or to a resource in the context's bundle via `getClass().getResource(name)`

*Returns* URL that Http Service can use to read the resource or null if the resource does not exist.

#### 102.10.2.6 **public boolean handleSecurity(HttpServletRequest request, HttpServletResponse response) throws IOException**

*request* The HTTP request.

*response* The HTTP response.

- Handles security for the specified request.

The Http Service calls this method prior to servicing the specified request. This method controls whether the request is processed in the normal manner or an error is returned.

If the request requires authentication and the Authorization header in the request is missing or not acceptable, then this method should set the WWW-Authenticate header in the response object, set the status in the response object to Unauthorized(401) and return false. See also RFC 2617: *HTTP Authentication: Basic and Digest Access Authentication* (available at <http://www.ietf.org/rfc/rfc2617.txt>).

If the request requires a secure connection and the `getScheme` method in the request does not return 'https' or some other acceptable secure protocol, then this method should set the status in the response object to Forbidden(403) and return false.

When this method returns false, the Http Service will send the response back to the client, thereby completing the request. When this method returns true, the Http Service will proceed with servicing the request.

If the specified request has been authenticated, this method must set the AUTHENTICATION\_TYPE request attribute to the type of authentication used, and the REMOTE\_USER request attribute to the remote user (request attributes are set using the `setAttribute` method on the request). If this method does not perform any authentication, it must not set these attributes.

If the authenticated user is also authorized to access certain resources, this method must set the AUTHORIZATION request attribute to the Authorization object obtained from the `org.osgi.service.useradmin.UserAdmin` service.

The servlet responsible for servicing the specified request determines the authentication type and remote user by calling the `getAuthType` and `getRemoteUser` methods, respectively, on the request.

*Returns* true if the request should be serviced, false if the request should not be serviced and Http Service will send the response back to the client.

*Throws* IOException— may be thrown by this method. If this occurs, the Http Service will terminate the request and close the socket.

### 102.10.3 public interface **HttpService**

The Http Service allows other bundles in the OSGi environment to dynamically register resources and servlets into the URI namespace of Http Service. A bundle may later unregister its resources or servlets.

*See Also* HttpContext

*No Implement* Consumers of this API must not implement this interface

#### 102.10.3.1 public **HttpContext createDefaultHttpContext()**

- Creates a default HttpContext for registering servlets or resources with the HttpService, a new HttpContext object is created each time this method is called.

The behavior of the methods on the default HttpContext is defined as follows:

- `getMimeType` - Does not define any customized MIME types for the Content-Type header in the response, and always returns null.
- `handleSecurity` - Performs implementation-defined authentication on the request.
- `getResource` - Assumes the named resource is in the context bundle; this method calls the context bundle's `Bundle.getResource` method, and returns the appropriate URL to access the resource. On a Java runtime environment that supports permissions, the Http Service needs to be granted `org.osgi.framework.AdminPermission[* ,RESOURCE]`.

*Returns* a default HttpContext object.

*Since* 1.1

#### 102.10.3.2 public void **registerResources(String alias,String name,HttpContext context) throws NamespaceException**

*alias* name in the URI namespace at which the resources are registered

*name* the base name of the resources that will be registered

*context* the HttpContext object for the registered resources, or null if a default HttpContext is to be created and used.

- Registers resources into the URI namespace.

The alias is the name in the URI namespace of the Http Service at which the registration will be mapped. An alias must begin with slash (/) and must not end with slash (/), with the exception that an alias of the form "/" is used to denote the root alias. The name parameter must also not end with slash (/) with the exception that a name of the form "/" is used to denote the root of the bundle. See the specification text for details on how HTTP requests are mapped to servlet and resource registrations.

For example, suppose the resource name /tmp is registered to the alias /files. A request for /files/foo.txt will map to the resource name /tmp/foo.txt.

```
httpservice.registerResources("/files", "/tmp", context);
```

The Http Service will call the HttpContext argument to map resource names to URLs and MIME types and to handle security for requests. If the HttpContext argument is null, a default HttpContext is used (see `createDefaultHttpContext()`).

*Throws* NamespaceException— if the registration fails because the alias is already in use.

IllegalArgumentException— if any of the parameters are invalid

**102.10.3.3 public void registerServlet(String alias,Servlet servlet,Dictionary initparams,HttpContext context) throws ServletException, NamespaceException**

*alias* name in the URI namespace at which the servlet is registered

*servlet* the servlet object to register

*initparams* initialization arguments for the servlet or null if there are none. This argument is used by the servlet's ServletConfig object.

*context* the HttpContext object for the registered servlet, or null if a default HttpContext is to be created and used.

- Registers a servlet into the URI namespace.

The alias is the name in the URI namespace of the Http Service at which the registration will be mapped.

An alias must begin with slash ("/") and must not end with slash ("/"), with the exception that an alias of the form "/" is used to denote the root alias. See the specification text for details on how HTTP requests are mapped to servlet and resource registrations.

The Http Service will call the servlet's init method before returning.

```
httpService.registerServlet("/myservlet", servlet, initparams, context);
```

Servlets registered with the same HttpContext object will share the same ServletContext.

The Http Service will call the context argument to support the ServletContext methods getResource,getResourceAsStream and getMimeType, and to handle security for requests. If the context argument is null, a default HttpContext object is used (see createDefaultHttpContext()).

*Throws* NamespaceException– if the registration fails because the alias is already in use.

javax.servlet.ServletException– if the servlet's init method throws an exception, or the given servlet object has already been registered at a different alias.

IllegalArgumentException– if any of the arguments are invalid

**102.10.3.4 public void unregister(String alias)**

*alias* name in the URI name-space of the registration to unregister

- Unregisters a previous registration done by registerServlet or registerResources methods.

After this call, the registered alias in the URI name-space will no longer be available. If the registration was for a servlet, the Http Service must call the destroy method of the servlet before returning.

If the bundle which performed the registration is stopped or otherwise "unget"s the Http Service without calling unregister(String) then Http Service must automatically unregister the registration. However, if the registration was for a servlet, the destroy method of the servlet will not be called in this case since the bundle may be stopped. unregister(String) must be explicitly called to cause the destroy method of the servlet to be called. This can be done in the BundleActivator.stop method of the bundle registering the servlet.

*Throws* IllegalArgumentException– if there is no registration for the alias or the calling bundle was not the bundle which registered the alias.

**102.10.4 public class NamespaceException extends Exception**

A NamespaceException is thrown to indicate an error with the caller's request to register a servlet or resources into the URI namespace of the Http Service. This exception indicates that the requested alias already is in use.

**102.10.4.1 public NamespaceException(String message)**

*message* the detail message

- Construct a NamespaceException object with a detail message.

**102.10.4.2 public NamespaceException(String message,Throwable cause)**

*message* The detail message.

*cause* The nested exception.

- Construct a NamespaceException object with a detail message and a nested exception.

**102.10.4.3 public Throwable getCause()**

- Returns the cause of this exception or null if no cause was set.

*Returns* The cause of this exception or null if no cause was set.

*Since* 1.2

**102.10.4.4 public Throwable getException()**

- Returns the nested exception.

This method predates the general purpose exception chaining mechanism. The `getCause()` method is now the preferred means of obtaining this information.

*Returns* The result of calling `getCause()`.

**102.10.4.5 public Throwable initCause(Throwable cause)**

*cause* The cause of this exception.

- Initializes the cause of this exception to the specified value.

*Returns* This exception.

*Throws* `IllegalArgumentException`– If the specified cause is this exception.

`IllegalStateException`– If the cause of this exception has already been set.

*Since* 1.2

## 102.11 References

- [1] *HTTP 1.0 Specification RFC-1945*  
<http://www.ietf.org/rfc/rfc1945.txt>, May 1996
- [2] *HTTP 1.1 Specification RFC-2616*  
<http://www.ietf.org/rfc/rfc2616.txt>, June 1999
- [3] *Java Servlet Technology*  
<http://www.oracle.com/technetwork/java/javaee/servlet/index.html>
- [4] *MIME Multipurpose Internet Mail Extension*  
<http://www.mhonarc.org/~ehood/MIME/MIME.html>
- [5] *Assigned MIME Media Types*  
<http://www.iana.org/assignments/media-types>
- [6] *Registration Procedures for new MIME media types*  
<http://www.ietf.org/rfc/rfc2048.txt>
- [7] *RFC 2617: HTTP Authentication: Basic and Digest Access Authentication*  
<http://www.ietf.org/rfc/rfc2617.txt>





# 103 Device Access Specification

## Version 1.1

### 103.1 Introduction

A Framework is a meeting point for services and devices from many different vendors: a meeting point where users add and cancel service subscriptions, newly installed services find their corresponding input and output devices, and device drivers connect to their hardware.

In an OSGi Framework, these activities will dynamically take place while the Framework is running. Technologies such as USB and IEEE 1394 explicitly support plugging and unplugging devices at any time, and wireless technologies are even more dynamic.

This flexibility makes it hard to configure all aspects of an OSGi Framework, particularly those relating to devices. When all of the possible services and device requirements are factored in, each OSGi Framework will be unique. Therefore, automated mechanisms are needed that can be extended and customized, in order to minimize the configuration needs of the OSGi environment.

The Device Access specification supports the coordination of automatic detection and attachment of existing devices on an OSGi Framework, facilitates hot-plugging and -unplugging of new devices, and downloads and installs device drivers on demand.

This specification, however, deliberately does not prescribe any particular device or network technology, and mentioned technologies are used as examples only. Nor does it specify a particular device discovery method. Rather, this specification focuses on the attachment of devices supplied by different vendors. It emphasizes the development of standardized device interfaces to be defined in device categories, although no such device categories are defined in this specification.

#### 103.1.1 Essentials

- *Embedded Devices* - OSGi bundles will likely run in embedded devices. This environment implies limited possibility for user interaction, and low-end devices will probably have resource limitations.
- *Remote Administration* - OSGi environments must support administration by a remote service provider.
- *Vendor Neutrality* - OSGi-compliant driver bundles will be supplied by different vendors; each driver bundle must be well-defined, documented, and replaceable.
- *Continuous Operation* - OSGi environments will be running for extended periods without being restarted, possibly continuously, requiring stable operation and stable resource consumption.
- *Dynamic Updates* - As much as possible, driver bundles must be individually replaceable without affecting unrelated bundles. In particular, the process of updating a bundle should not require a restart of the whole OSGi Framework or disrupt operation of connected devices.

A number of requirements must be satisfied by Device Access implementations in order for them to be OSGi-compliant. Implementations must support the following capabilities:

- *Hot-Plugging* - Plugging and unplugging of devices at any time if the underlying hardware and drivers allow it.
- *Legacy Systems* - Device technologies which do not implement the automatic detection of plugged and unplugged devices.

- *Dynamic Device Driver Loading* - Loading new driver bundles on demand with no prior device-specific knowledge of the Device service.
- *Multiple Device Representations* - Devices to be accessed from multiple levels of abstraction.
- *Deep Trees* - Connections of devices in a tree of mixed network technologies of arbitrary depth.
- *Topology Independence* - Separation of the interfaces of a device from where and how it is attached.
- *Complex Devices* - Multifunction devices and devices that have multiple configurations.

### 103.1.2 Operation

This specification defines the behavior of a device manager (which is *not* a service as might be expected). This device manager detects registration of Device services and is responsible for associating these devices with an appropriate Driver service. These tasks are done with the help of Driver Locator services and the Driver Selector service that allow a device manager to find a Driver bundle and install it.

### 103.1.3 Entities

The main entities of the Device Access specification are:

- *Device Manager* - The bundle that controls the initiation of the attachment process behind the scenes.
- *Device Category* - Defines how a Driver service and a Device service can cooperate.
- *Driver* - Competes for attaching Device services of its recognized device category. See *Driver Services* on page 67.
- *Device* - A representation of a physical device or other entity that can be attached by a Driver service. See *Device Services* on page 63.
- *DriverLocator* - Assists in locating bundles that provide a Driver service. See *Driver Locator Service* on page 73.
- *DriverSelector* - Assists in selecting which Driver service is best suited to a Device service. See *The Driver Selector Service* on page 76.

Figure 103.1 show the classes and their relationships.

Figure 103.1 Device Access Class Overview

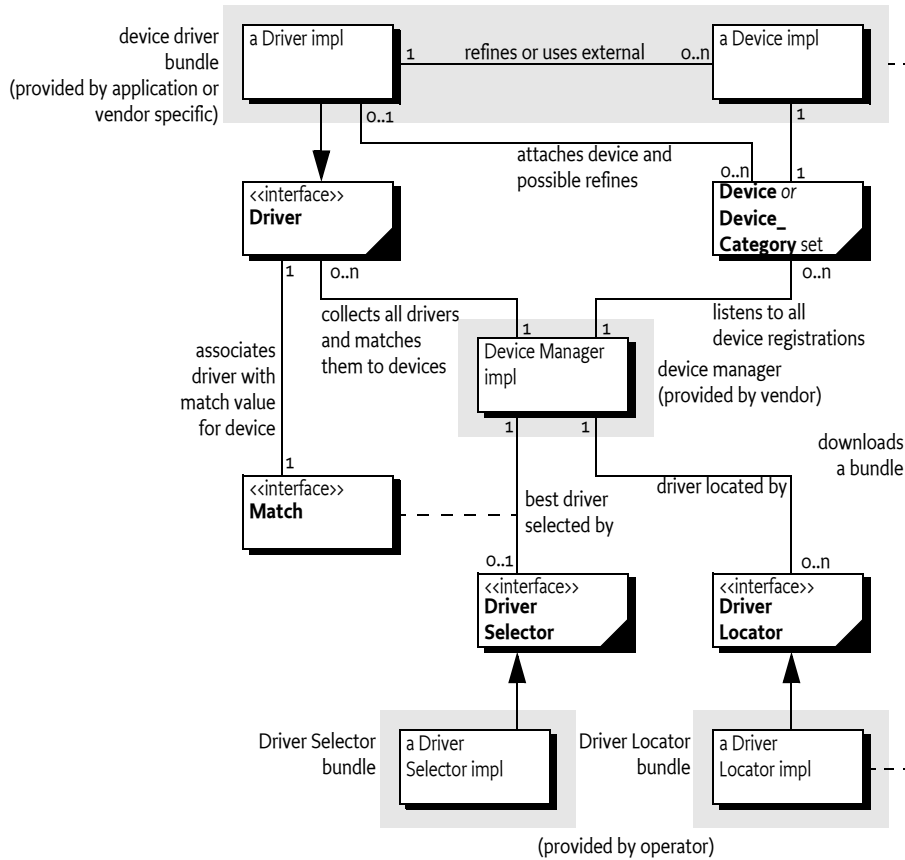

## 103.2 Device Services

A Device service represents some form of a device. It can represent a hardware device, but that is not a requirement. Device services differ widely: some represent individual physical devices and others represent complete networks. Several Device services can even simultaneously represent the same physical device at different levels of abstraction. For example:

- A USB network.
- A device attached on the USB network.
- The same device recognized as a USB to Ethernet bridge.
- A device discovered on the Ethernet using Salutation.
- The same device recognized as a simple printer.
- The same printer refined to a PostScript printer.

A device can also be represented in different ways. For example, a USB mouse can be considered as:

- A USB device which delivers information over the USB bus.
- A mouse device which delivers x and y coordinates and information about the state of its buttons.

Each representation has specific implications:

- That a particular device is a mouse is irrelevant to an application which provides management of USB devices.
- That a mouse is attached to a USB bus or a serial port would be inconsequential to applications that respond to mouse-like input.

Device services must belong to a defined *device category*, or else they can implement a generic service which models a particular device, independent of its underlying technology. Examples of this type of implementation could be Sensor or Actuator services.

A device category specifies the methods for communicating with a Device service, and enables interoperability between bundles that are based on the same underlying technology. Generic Device services will allow interoperability between bundles that are not coupled to specific device technologies.

For example, a device category is required for the USB, so that Driver bundles can be written that communicate to the devices that are attached to the USB. If a printer is attached, it should also be available as a generic Printer service defined in a Printer service specification, indistinguishable from a Printer service attached to a parallel port. Generic categories, such as a Printer service, should also be described in a Device Category.

It is expected that most Device service objects will actually represent a physical device in some form, but that is not a requirement of this specification. A Device service is represented as a normal service in the OSGi Framework and all coordination and activities are performed upon Framework services. This specification does not limit a bundle developer from using Framework mechanisms for services that are not related to physical devices.

### 103.2.1 Device Service Registration

A Device service is defined as a normal service registered with the Framework that either:

- Registers a service object under the interface `org.osgi.service.Device` with the Framework, or
- Sets the `DEVICE_CATEGORY` property in the registration. The value of `DEVICE_CATEGORY` is an array of String objects of all the device categories that the device belongs to. These strings are defined in the associated device category.

If this document mentions a Device service, it is meant to refer to services registered with the name `org.osgi.service.device.Device` or services registered with the `DEVICE_CATEGORY` property set.

When a Device service is registered, additional properties may be set that describe the device to the device manager and potentially to the end users. The following properties have their semantics defined in this specification:

- `DEVICE_CATEGORY` - A marker property indicating that this service must be regarded as a Device service by the device manager. Its value is of type `String[]`, and its meaning is defined in the associated device category specification.
- `DEVICE_DESCRIPTION` - Describes the device to an end user. Its value is of type `String`.
- `DEVICE_SERIAL` - A unique serial number for this device. If the device hardware contains a serial number, the driver bundle is encouraged to specify it as this property. Different Device services representing the same physical hardware at different abstraction levels should set the same `DEVICE_SERIAL`, thus simplifying identification. Its value is of type `String`.
- `service.pid` - Service Persistent ID (PID), defined in `org.osgi.framework.Constants`. Device services should set this property. It must be unique among all registered services. Even different abstraction levels of the same device must use different PIDs. The service PIDs must be reproducible, so that every time the same hardware is plugged in, the same PIDs are used.

### 103.2.2 Device Service Attachment

When a Device service is registered with the Framework, the device manager is responsible for finding a suitable Driver service and instructing it to attach to the newly registered Device service. The

Device service itself is passive: it only registers a Device service with the Framework and then waits until it is called.

The actual communication with the underlying physical device is not defined in the Device interface because it differs significantly between different types of devices. The Driver service is responsible for attaching the device in a device type-specific manner. The rules and interfaces for this process must be defined in the appropriate device category.

If the device manager is unable to find a suitable Driver service, the Device service remains unattached. In that case, if the service object implements the Device interface, it must receive a call to the `noDriverFound()` method. The Device service can wait until a new driver is installed, or it can unregister and attempt to register again with different properties that describe a more generic device or try a different configuration.

#### 103.2.2.1 Idle Device Service

The main purpose of the device manager is to try to attach drivers to idle devices. For this purpose, a Device service is considered *idle* if no bundle that itself has registered a Driver service is using the Device service.

#### 103.2.2.2 Device Service Unregistration

When a Device service is unregistered, no immediate action is required by the device manager. The normal service of unregistering events, provided by the Framework, takes care of propagating the unregistration information to affected drivers. Drivers must take the appropriate action to release this Device service and perform any necessary cleanup, as described in their device category specification.

The device manager may, however, take a device unregistration as an indication that driver bundles may have become idle and are thus eligible for removal. It is therefore important for Device services to unregister their service object when the underlying entity becomes unavailable.

## 103.3 Device Category Specifications

A device category specifies the rules and interfaces needed for the communication between a Device service and a Driver service. Only Device services and Driver services of the same device category can communicate and cooperate.

The Device Access service specification is limited to the attachment of Device services by Driver services, and does *not* enumerate different device categories.

Other specifications must specify a number of device categories before this specification can be made operational. Without a set of defined device categories, no inter-operability can be achieved.

Device categories are related to a specific device technology, such as USB, IEEE 1394, JINI, UPnP, Salutation, CEBus, Lonworks, and others. The purpose of a device category specification is to make all Device services of that category conform to an agreed interface, so that, for example, a USB Driver service of vendor A can control Device services from vendor B attached to a USB bus.

This specification is limited to defining the guidelines for device category definitions only. Device categories may be defined by the OSGi organization or by external specification bodies - for example, when these bodies are associated with a specific device technology.

#### 103.3.1 Device Category Guidelines

A device category definition comprises the following elements:

- An interface that all devices belonging to this category must implement. This interface should lay out the rules of how to communicate with the underlying device. The specification body may define its own device interfaces (or classes) or leverage existing ones. For example, a serial port

device category could use the `javax.comm.SerialPort` interface which is defined in [1] *Java Communications API*.

When registering a device belonging to this category with the Framework, the interface or class name for this category must be included in the registration.

- A set of service registration properties, their data types, and semantics, each of which must be declared as either MANDATORY or OPTIONAL for this device category.
- A range of match values specific to this device category. Matching is explained later in *The Device Attachment Algorithm* on page 77.

### 103.3.2 Sample Device Category Specification

The following is a partial example of a fictitious device category:

```
public interface /* com.acme.widget.* / WidgetDevice{
    int MATCH_SERIAL          = 10;
    int MATCH_VERSION         = 8;
    int MATCH_MODEL           = 6;
    int MATCH_MAKE            = 4;
    int MATCH_CLASS           = 2;
    void sendPacket( byte [] data );
    byte [] receivePacket( long timeout );
}
```

Devices in this category must implement the interface `com.acme.widget.WidgetDevice` to receive attachments from Driver services in this category.

Device properties for this fictitious category are defined in the following table.

Table 103.1

*Example Device Category Properties, M=Mandatory, O=Optional*

Property name	M/O	Type	Value
DEVICE_CATEGORY	M	String[]	{"Widget"}
com.acme.class	M	String	A class description of this device. For example "audio", "video", "serial", etc. An actual device category specification should contain an exhaustive list and define a process to add new classes.
com.acme.model	M	String	A definition of the model. This is usually vendor specific. For example "Mouse".
com.acme.manufacturer	M	String	Manufacturer of this device, for example "ACME Widget Division".
com.acme.revision	O	String	Revision number. For example, "42".
com.acme.serial	O	String	A serial number. For example "SN6751293-12-2112/A".

### 103.3.3 Match Example

Driver services and Device services are connected via a matching process that is explained in *The Device Attachment Algorithm* on page 77. The Driver service plays a pivotal role in this matching process. It must inspect the Device service (from its `ServiceReference` object) that has just been registered and decide if it potentially could cooperate with this Device service.

It must be able to answer a value indicating the quality of the match. The scale of this match value must be defined in the device category so as to allow Driver services to match on a fair basis. The scale must start at least at 1 and go upwards.

Driver services for this sample device category must return one of the match codes defined in the `com.acme.widget.WidgetDevice` interface or `Device.MATCH_NONE` if the Device service is not recognized. The device category must define the exact rules for the match codes in the device category specification. In this example, a small range from 2 to 10 (`MATCH_NONE` is 0) is defined for `WidgetDevice` devices. They are named in the `WidgetDevice` interface for convenience and have the following semantics.

Table 103.2 Sample Device Category Match Scale

Match name	Value	Description
<code>MATCH_SERIAL</code>	10	An exact match, including the serial number.
<code>MATCH_VERSION</code>	8	Matches the right class, make model, and version.
<code>MATCH_MODEL</code>	6	Matches the right class and make model.
<code>MATCH_MAKE</code>	4	Matches the make.
<code>MATCH_CLASS</code>	2	Only matches the class.

A Driver service should use the constants to return when it decides how closely the Device service matches its suitability. For example, if it matches the exact serial number, it should return `MATCH_SERIAL`.

## 103.4 Driver Services

A Driver service is responsible for attaching to suitable Device services under control of the device manager. Before it can attach a Device service, however, it must compete with other Driver services for control.

If a Driver service wins the competition, it must attach the device in a device category-specific way. After that, it can perform its intended functionality. This functionality is not defined here nor in the device category; this specification only describes the behavior of the Device service, not how the Driver service uses it to implement its intended functionality. A Driver service may register one or more new Device services of another device category or a generic service which models a more refined form of the device.

Both refined Device services as well as generic services should be defined in a Device Category. See *Device Category Specifications* on page 65.

### 103.4.1 Driver Bundles

A Driver service is, like *all* services, implemented in a bundle, and is recognized by the device manager by registering one or more Driver service objects with the Framework.

Such bundles containing one or more Driver services are called *driver bundles*. The device manager must be aware of the fact that the cardinality of the relationship between bundles and Driver services is 1:1...\*.

A driver bundle must register *at least* one Driver service in its `BundleActivator.start` implementation.

### 103.4.2 Driver Taxonomy

Device Drivers may belong to one of the following categories:

- Base Drivers (Discovery, Pure Discovery and Normal)
- Refining Drivers
- Network Drivers

- Composite Drivers
- Referring Drivers
- Bridging Drivers
- Multiplexing Drivers
- Pure Consuming Drivers

This list is not definitive, and a Driver service is not required to fit into one of these categories. The purpose of this taxonomy is to show the different topologies that have been considered for the Device Access service specification.

Figure 103.2 Legend for Device Driver Services Taxonomy



**103.4.2.1 Base Drivers**

The first category of device drivers are called *base drivers* because they provide the lowest-level representation of a physical device. The distinguishing factor is that they are not registered as Driver services because they do not have to compete for access to their underlying technology.

Figure 103.3 Base Driver Types

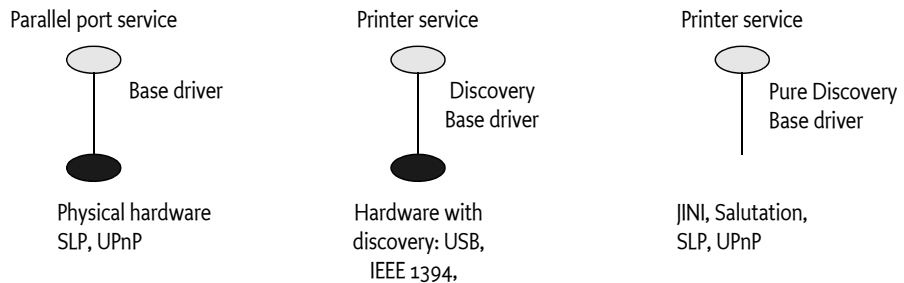

Base drivers discover physical devices using code not specified here (for example, through notifications from a device driver in native code) and then register corresponding Device services.

When the hardware supports a discovery mechanism and reports a physical device, a Device service is then registered. Drivers supporting a discovery mechanism are called *discovery base drivers*.

An example of a discovery base driver is a USB driver. Discovered USB devices are registered with the Framework as a generic USB Device service. The USB specification (see [2] *USB Specification*) defines a tightly integrated discovery method. Further, devices are individually addressed; no provision exists for broadcasting a message to all devices attached to the USB bus. Therefore, there is no reason to expose the USB network itself; instead, a discovery base driver can register the individual devices as they are discovered.

Not all technologies support a discovery mechanism. For example, most serial ports do not support detection, and it is often not even possible to detect whether a device is attached to a serial port.



Although each driver bundle should perform discovery on its own, a driver for a non-discoverable serial port requires external help - either through a user interface or by allowing the Configuration Admin service to configure it.

It is possible for the driver bundle to combine automatic discovery of Plug and Play-compliant devices with manual configuration when non-compliant devices are plugged in.

**103.4.2.2 Refining Drivers**

The second category of device drivers are called *refining drivers*. Refining drivers provide a refined view of a physical device that is already represented by another Device service registered with the Framework. Refining drivers register a Driver service with the Framework. This Driver service is used by the device manager to attach the refining driver to a less refined Device service that is registered as a result of events within the Framework itself.

Figure 103.4 Refining Driver Diagram

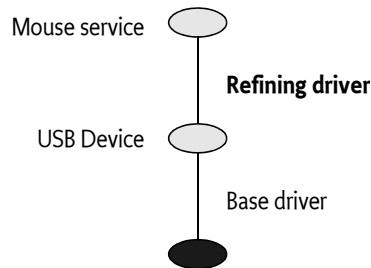

An example of a refining driver is a mouse driver, which is attached to the generic USB Device service representing a physical mouse. It then registers a new Device service which represents it as a Mouse service, defined elsewhere.

The majority of drivers fall into the refining driver type.

**103.4.2.3 Network Drivers**

An Internet Protocol (IP) capable network such as Ethernet supports individually addressable devices and allows broadcasts, but does not define an intrinsic discovery protocol. In this case, the entire network should be exposed as a single Device service.

Figure 103.5 Network Driver diagram

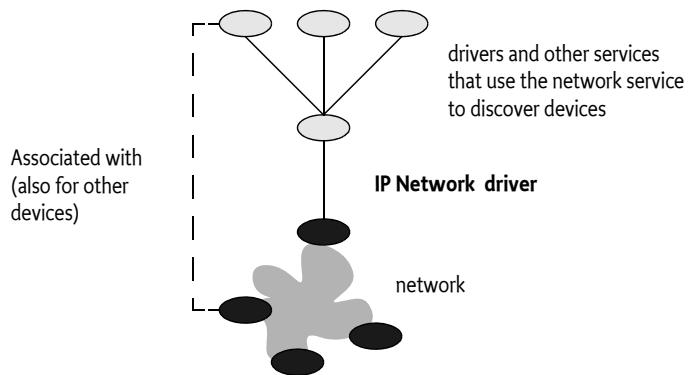

**103.4.2.4 Composite Drivers**

Complex devices can often be broken down into several parts. Drivers that attach to a single service and then register multiple Device services are called *composite drivers*. For example, a USB speaker

containing software-accessible buttons can be registered by its driver as two separate Device services: an Audio Device service and a Button Device service.

Figure 103.6 Composite Driver structure

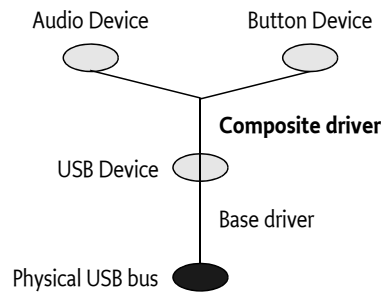

This approach can greatly reduce the number of interfaces needed, as well as enhance reusability.

#### 103.4.2.5 Referring Drivers

A referring driver is actually not a driver in the sense that it controls Device services. Instead, it acts as an intermediary to help locate the correct driver bundle. This process is explained in detail in *The Device Attachment Algorithm* on page 77.

A referring driver implements the call to the attach method to inspect the Device service, and decides which Driver bundle would be able to attach to the device. This process can actually involve connecting to the physical device and communicating with it. The attach method then returns a String object that indicates the DRIVER\_ID of another driver bundle. This process is called a referral.

For example, a vendor ACME can implement one driver bundle that specializes in recognizing all of the devices the vendor produces. The referring driver bundle does not contain code to control the device - it contains only sufficient logic to recognize the assortment of devices. This referring driver can be small, yet can still identify a large product line. This approach can drastically reduce the amount of downloading and matching needed to find the correct driver bundle.

#### 103.4.2.6 Bridging Drivers

A bridging driver registers a Device service from one device category but attaches it to a Device service from another device category.

Figure 103.7 Bridging Driver Structure

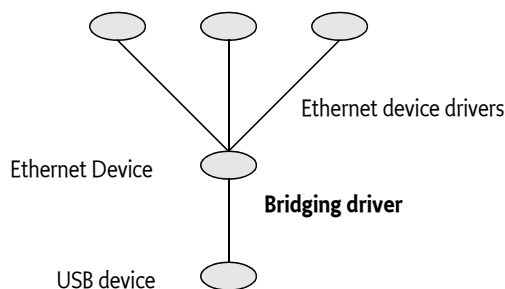

For example, USB to Ethernet bridges exist that allow connection to an Ethernet network through a USB device. In this case, the top level of the USB part of the Device service stack would be an Ethernet Device service. But the same Ethernet Device service can also be the bottom layer of an Ethernet layer of the Device service stack. A few layers up, a bridge could connect into yet another network.

The stacking depth of Device services has no limit, and the same drivers could in fact appear at different levels in the same Device service stack. The graph of drivers-to-Device services roughly mirrors the hardware connections.

#### 103.4.2.7 Multiplexing Drivers

A *multiplexing driver* attaches a number of Device services and aggregates them in a new Device service.

Figure 103.8 Multiplexing Driver Structure

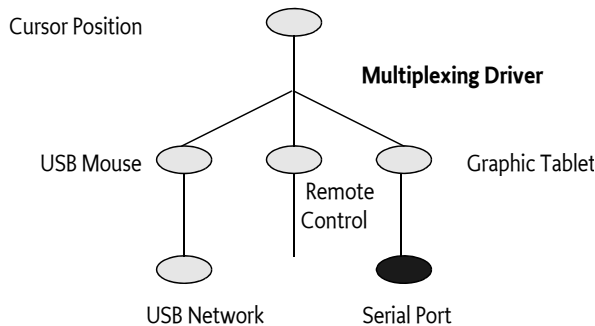

For example, assume that a system has a mouse on USB, a graphic tablet on a serial port, and a remote control facility. Each of these would be registered as a service with the Framework. A multiplexing driver can attach all three, and can merge the different positions in a central Cursor Position service.

#### 103.4.2.8 Pure Consuming Drivers

A *pure consuming driver* bundle will attach to devices without registering a refined version.

Figure 103.9 Pure Consuming Driver Structure

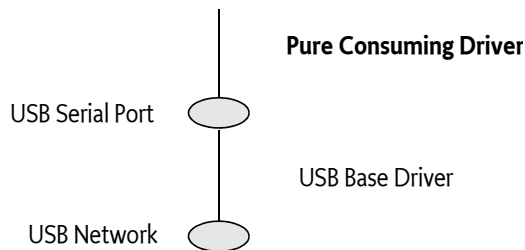

For example, one driver bundle could decide to handle all serial ports through `javax.comm` instead of registering them as services. When a USB serial port is plugged in, one or more Driver services are attached, resulting in a Device service stack with a Serial Port Device service. A pure consuming driver may then attach to the Serial Port Device service and register a new serial port with the `javax.comm.*` registry instead of the Framework service registry. This registration effectively transfers the device from the OSGi environment into another environment.

#### 103.4.2.9 Other Driver Types

It should be noted that any bundle installed in the OSGi environment may get and use a Device service without having to register a Driver service.

The following functionality is offered to those bundles that do register a Driver service and conform to the this specification:

- The bundles can be installed and uninstalled on demand.
- Attachment to the Device service is only initiated after the winning the competition with other drivers.

### 103.4.3 Driver Service Registration

Drivers are recognized by registering a Driver service with the Framework. This event makes the device manager aware of the existence of the Driver service. A Driver service registration must have a `DRIVER_ID` property whose value is a String object, uniquely identifying the driver to the device manager. The device manager must use the `DRIVER_ID` to prevent the installation of duplicate copies of the same driver bundle.

Therefore, this `DRIVER_ID` must:

- Depend only on the specific behavior of the driver, and thus be independent of unrelated aspects like its location or mechanism of downloading.
- Start with the reversed form of the domain name of the company that implements it: for example, `com.acme.widget.1.1`.
- Differ from the `DRIVER_ID` of drivers with different behavior. Thus, it must *also* be different for each revision of the same driver bundle so they may be distinguished.

When a new Driver service is registered, the Device Attachment Algorithm must be applied to each idle Device service. This requirement gives the new Driver service a chance to compete with other Driver services for attaching to idle devices. The techniques outlined in *Optimizations* on page 80 can provide significant shortcuts for this situation.

As a result, the Driver service object can receive match and attach requests before the method which registered the service has returned.

This specification does not define any method for new Driver services to *steal* already attached devices. Once a Device service has been attached by a Driver service, it can only be released by the Driver service itself.

### 103.4.4 Driver Service Unregistration

When a Driver service is unregistered, it must release all Device services to which it is attached. Thus, *all* its attached Device services become idle. The device manager must gather all of these idle Device services and try to re-attach them. This condition gives other Driver services a chance to take over the refinement of devices after the unregistering driver. The techniques outlined in *Optimizations* on page 80 can provide significant shortcuts for this situation.

A Driver service that is installed by the device manager must remain registered as long as the driver bundle is active. Therefore, a Driver service should only be unregistered if the driver bundle is stopping, an occurrence which may precede its being uninstalled or updated. Driver services should thus not unregister in an attempt to minimize resource consumption. Such optimizations can easily introduce race conditions with the device manager.

### 103.4.5 Driver Service Methods

The Driver interface consists of the following methods:

- `match(ServiceReference)` - This method is called by the device manager to find out how well this Driver service matches the Device service as indicated by the `ServiceReference` argument. The value returned here is specific for a device category. If this Device service is of another device category, the value `Device.MATCH_NONE` must be returned. Higher values indicate a better match. For the exact matching algorithm, see *The Device Attachment Algorithm* on page 77.

Driver match values and referrals must be deterministic, in that repeated calls for the same Device service must return the same results so that results can be cached by the device manager.

- [attach\(ServiceReference\)](#) - If the device manager decides that a Driver service should be attached to a Device service, it must call this method on the Driver service object. Once this method is called, the Device service is regarded as attached to that Driver service, and no other Driver service must be called to attach to the Device service. The Device service must remain *owned* by the Driver service until the Driver bundle is stopped. No unattach method exists.

The attach method should return null when the Device service is correctly attached. A referring driver (see *Referring Drivers* on page 70) can return a String object that specifies the DRIVER\_ID of a driver that can handle this Device service. In this case, the Device service is not attached and the device manager must attempt to install a Driver service with the same DRIVER\_ID via a Driver Locator service. The attach method must be deterministic as described in the previous method.

### 103.4.6 Idle Driver Bundles

An idle Driver bundle is a bundle with a registered Driver service, and is not attached to any Device service. Idle Driver bundles are consuming resources in the OSGi Framework. The device manager should uninstall bundles that it has installed and which are idle.

## 103.5 Driver Locator Service

The device manager must automatically install Driver bundles, which are obtained from Driver Locator services, when new Device services are registered.

A Driver Locator service encapsulates the knowledge of how to fetch the Driver bundles needed for a specific Device service. This selection is made on the properties that are registered with a device: for example, DEVICE\_CATEGORY and any other properties registered with the Device service registration.

The purpose of the Driver Locator service is to separate the mechanism from the policy. The decision to install a new bundle is made by the device manager (the mechanism), but a Driver Locator service decides which bundle to install and from where the bundle is downloaded (the policy).

Installing bundles has many consequences for the security of the system, and this process is also sensitive to network setup and other configuration details. Using Driver Locator services allows the Operator to choose a strategy that best fits its needs.

Driver services are identified by the DRIVER\_ID property. Driver Locator services use this particular ID to identify the bundles that can be installed. Driver ID properties have uniqueness requirements as specified in *Device Service Registration* on page 64. This uniqueness allows the device manager to maintain a list of Driver services and prevent unnecessary installs.

An OSGi Framework can have several different Driver Locator services installed. The device manager must consult all of them and use the combined result set, after pruning duplicates based on the DRIVER\_ID values.

### 103.5.1 The DriverLocator Interface

The [DriverLocator](#) interface allows suitable driver bundles to be located, downloaded, and installed on demand, even when completely unknown devices are detected.

It has the following methods:

- [findDrivers\(Dictionary\)](#) - This method returns an array of driver IDs that potentially match a service described by the properties in the Dictionary object. A driver ID is the String object that is registered by a Driver service under the DRIVER\_ID property.
- [loadDriver\(String\)](#) - This method returns an InputStream object that can be used to download the bundle containing the Driver service as specified by the driver ID argument. If the Driver Lo-

locator service cannot download such a bundle, it should return null. Once this bundle is downloaded and installed in the Framework, it must register a Driver service with the DRIVER\_ID property set to the value of the String argument.

### 103.5.2 A Driver Example

The following example shows a very minimal Driver service implementation. It consists of two classes. The first class is SerialWidget. This class tracks a single WidgetDevice from *Sample Device Category Specification* on page 66. It registers a javax.comm.SerialPort service, which is a general serial port specification that could also be implemented from other device categories like USB, a COM port, etc. It is created when the SerialWidgetDriver object is requested to attach a WidgetDevice by the device manager. It registers a new javax.comm.SerialPort service in its constructor.

The org.osgi.util.tracker.ServiceTracker is extended to handle the Framework events that are needed to simplify tracking this service. The removedService method of this class is overridden to unregister the SerialPort when the underlying WidgetDevice is unregistered.

```
package com.acme.widget;
import org.osgi.service.device.*;
import org.osgi.framework.*;
import org.osgi.util.tracker.*;

class SerialWidget extends ServiceTracker
    implements javax.comm.SerialPort,
               org.osgi.service.device.Constants {
    ServiceRegistration registration;

    SerialWidget( BundleContext c, ServiceReference r ) {
        super( c, r, null );
        open();
    }

    public Object addingService( ServiceReference ref ) {
        WidgetDevice dev = (WidgetDevice)
            context.getService( ref );
        registration = context.registerService(
            javax.comm.SerialPort.class.getName(),
            this,
            null );
        return dev;
    }

    public void removedService( ServiceReference ref,
        Object service ) {
        registration.unregister();
        context.ungetService(ref);
    }
    ... methods for javax.comm.SerialPort that are
    ... converted to underlying WidgetDevice
}
```

A SerialWidgetDriver object is registered with the Framework in the Bundle Activator start method under the Driver interface. The device manager must call the match method for each idle Device service that is registered. If it is chosen by the device manager to control this Device service, a new SerialWidget is created that offers serial port functionality to other bundles.

```
public class SerialWidgetDriver implements Driver {
```

```
BundleContext context;

String      spec =
    "&"
    +" (objectclass=com.acme.widget.WidgetDevice) "
    +" (DEVICE_CATEGORY=WidgetDevice) "
    +" (com.acme.class=Serial) "
    +" ";

Filter      filter;

SerialWidgetDriver( BundleContext context )
    throws Exception {
    this.context = context;
    filter = context.createFilter(spec);
}
public int match( ServiceReference d ) {
    if ( filter.match( d ) )
        return WidgetDevice.MATCH_CLASS;
    else
        return Device.MATCH_NONE;
}
public synchronized String attach(ServiceReference r){
    new SerialWidget( context, r );
}
}
```

## 103.6 The Driver Selector Service

The purpose of the Driver Selector service is to customize the selection of the best Driver service from a set of suitable Driver bundles. The device manager has a default algorithm as described in *The Device Attachment Algorithm* on page 77. When this algorithm is not sufficient and requires customizing by the operator, a bundle providing a Driver Selector service can be installed in the Framework. This service must be used by the device manager as the final arbiter when selecting the best match for a Device service.

The Driver Selector service is a singleton; only one such service is recognized by the device manager. The Framework method `BundleContext.getServiceReference` must be used to obtain a Driver Selector service. In the erroneous case that multiple Driver Selector services are registered, the `service.ranking` property will thus define which service is actually used.

A device manager implementation must invoke the method `select(ServiceReference,Match[])`. This method receives a Service Reference to the Device service and an array of `Match` objects. Each `Match` object contains a link to the `ServiceReference` object of a Driver service and the result of the match value returned from a previous call to `Driver.match`. The Driver Selector service should inspect the array of `Match` objects and use some means to decide which Driver service is best suited. The index of the best match should be returned. If none of the `Match` objects describe a possible Driver service, the implementation must return `DriverSelector.SELECT_NONE (-1)`.

## 103.7 Device Manager

Device Access is controlled by the device manager in the background. The device manager is responsible for initiating all actions in response to the registration, modification, and unregistration of Device services and Driver services, using Driver Locator services and a Driver Selector service as helpers.

The device manager detects the registration of Device services and coordinates their attachment with a suitable Driver service. Potential Driver services do not have to be active in the Framework to be eligible. The device manager must use Driver Locator services to find bundles that might be suitable for the detected Device service and that are not currently installed. This selection is done via a `DRIVER_ID` property that is unique for each Driver service.

The device manager must install and start these bundles with the help of a Driver Locator service. This activity must result in the registration of one or more Driver services. All available Driver services, installed by the device manager and also others, then participate in a bidding process. The Driver service can inspect the Device service through its `ServiceReference` object to find out how well this Driver service matches the Device service.

If a Driver Selector service is available in the Framework service registry, it is used to decide which of the eligible Driver services is the best match.

If no Driver Selector service is available, the highest bidder must win, with tie breaks defined on the `service.ranking` and `service.id` properties. The selected Driver service is then asked to attach the Device service.

If no Driver service is suitable, the Device service remains idle. When new Driver bundles are installed, these idle Device services must be reattached.

The device manager must reattach a Device service if, at a later time, a Driver service is unregistered due to an uninstallation or update. At the same time, however, it should prevent superfluous and non-optimal reattachments. The device manager should also garbage-collect driver bundles it installed which are no longer used.



The device manager is a singleton. Only one device manager may exist, and it must have no public interface.

### **103.7.1 Device Manager Startup**

To prevent race conditions during Framework startup, the device manager must monitor the state of Device services and Driver services immediately when it is started. The device manager must not, however, begin attaching Device services until the Framework has been fully started, to prevent superfluous or non-optimal attachments.

The Framework has completed starting when the FrameworkEvent.STARTED event has been published. Publication of that event indicates that Framework has finished all its initialization and all bundles are started. If the device manager is started after the Framework has been initialized, it should detect the state of the Framework by examining the state of the system bundle.

### **103.7.2 The Device Attachment Algorithm**

A key responsibility of the device manager is to attach refining drivers to idle devices. The following diagram illustrates the device attachment algorithm.

Figure 103.10 Device Attachment Algorithm

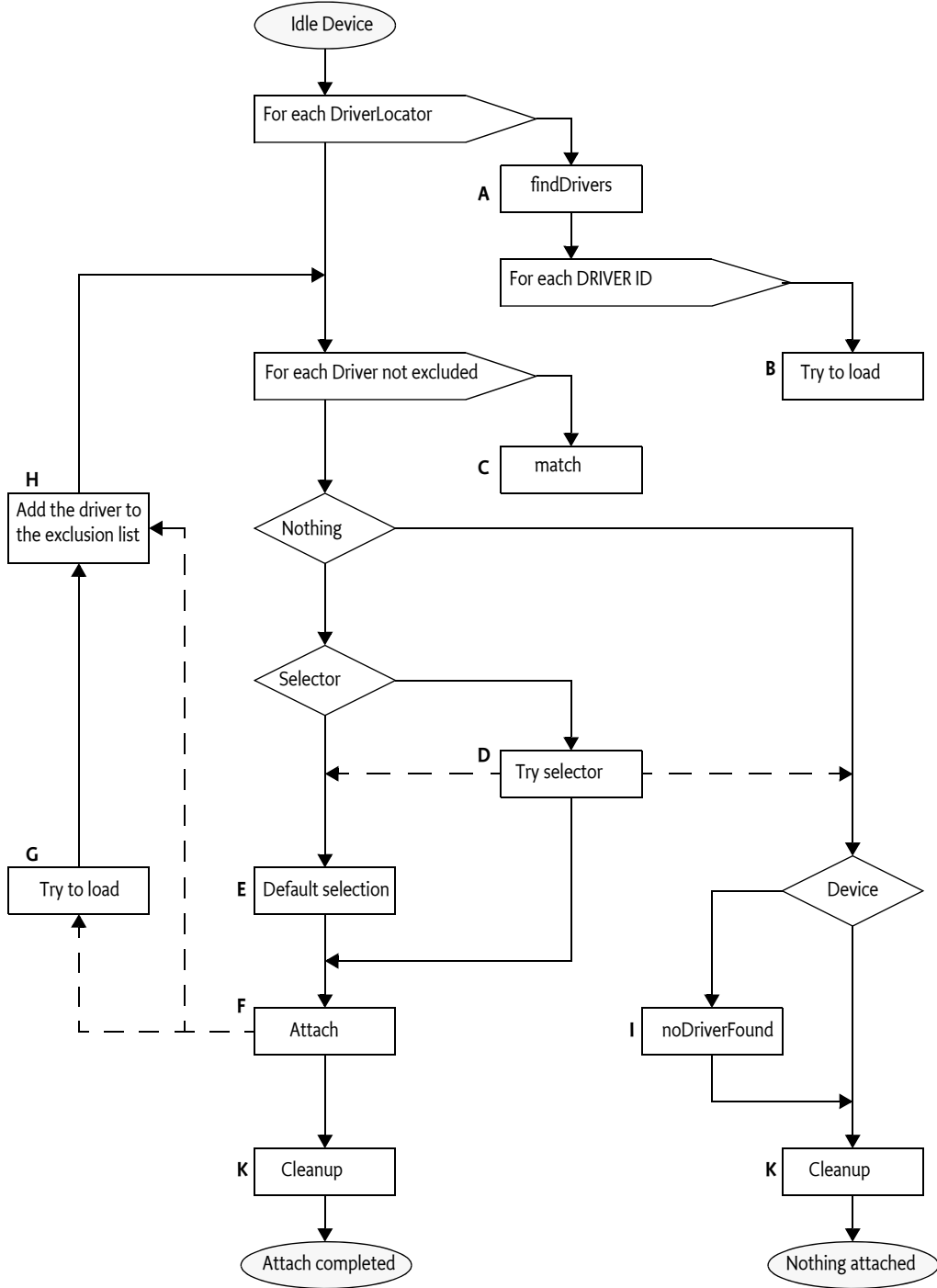

### 103-7.3 Legend

Table 103.3 *Driver attachment algorithm*

Step	Description
A	<p>DriverLocator.findDrivers is called for each registered Driver Locator service, passing the properties of the newly detected Device service. Each method call returns zero or more DRIVER_ID values (identifiers of particular driver bundles).</p> <p>If the findDrivers method throws an exception, it is ignored, and processing continues with the next Driver Locator service. See <i>Optimizations</i> on page 80 for further guidance on handling exceptions.</p>
B	<p>For each found DRIVER_ID that does not correspond to an already registered Driver service, the device manager calls DriverLocator.loadDriver to return an InputStream containing the driver bundle. Each call to loadDriver is directed to one of the Driver Locator services that mentioned the DRIVER_ID in step A. If the loadDriver method fails, the other Driver Locator objects are tried. If they all fail, the driver bundle is ignored.</p> <p>If this method succeeds, the device manager installs and starts the driver bundle. Driver bundles must register their Driver services synchronously during bundle activation.</p>
C	<p>For each Driver service, except those on the exclusion list, call its Driver.match method, passing the ServiceReference object to the Device service.</p> <p>Collect all successful matches - that is, those whose return values are greater than Device.MATCH_NONE - in a list of active matches. A match call that throws an exception is considered unsuccessful and is not added to the list.</p>
D	<p>If there is a Driver Selector service, the device manager calls the DriverSelector.select method, passing the array of active Match objects.</p> <p>If the Driver Selector service returns the index of one of the Match objects from the array, its associated Driver service is selected for attaching the Device service. If the Driver Selector service returns DriverSelector.SELECT_NONE, no Driver service must be considered for attaching the Device service.</p> <p>If the Driver Selector service throws an exception or returns an invalid result, the default selection algorithm is used.</p> <p>Only one Driver Selector service is used, even if there is more than one registered in the Framework. See <i>The Driver Selector Service</i> on page 76.</p>
E	<p>The winner is the one with the highest match value. Tie breakers are respectively:</p> <ul style="list-style-type: none"> <li>• Highest service.ranking property.</li> <li>• Lowest service.id property.</li> </ul>
F	<p>The selected Driver service's attach method is called. If the attach method returns null, the Device service has been successfully attached. If the attach method returns a String object, it is interpreted as a referral to another Driver service and processing continues at G. See <i>Referring Drivers</i> on page 70.</p> <p>If an exception is thrown, the Driver service has failed, and the algorithm proceeds to try another Driver service after excluding this one from further consideration at Step H.</p>

Step	Description
G	The device manager attempts to load the referred driver bundle in a manner similar to Step B, except that it is unknown which Driver Locator service to use. Therefore, the loadDriver method must be called on each Driver Locator service until one succeeds (or they all fail). If one succeeds, the device manager installs and starts the driver bundle. The driver bundle must register a Driver service during its activation which must be added to the list of Driver services in this algorithm.
H	The referring driver bundle is added to the exclusion list. Because each new referral adds an entry to the exclusion list, which in turn disqualifies another driver from further matching, the algorithm cannot loop indefinitely. This list is maintained for the duration of this algorithm. The next time a new Device service is processed, the exclusion list starts out empty.
I	If no Driver service attached the Device service, the Device service is checked to see whether it implements the Device interface. If so, the noDriverFound method is called. Note that this action may cause the Device service to unregister and possibly a new Device service (or services) to be registered in its place. Each new Device service registration must restart the algorithm from the beginning.
K	Whether an attachment was successful or not, the algorithm may have installed a number of driver bundles. The device manager should remove any idle driver bundles that it installed.

### 103.7.4 Optimizations

Optimizations are explicitly allowed and even recommended for an implementation of a device manager. Implementations may use the following assumptions:

- Driver match values and referrals must be deterministic, in that repeated calls for the same Device service must return the same results.
- The device manager may cache match values and referrals. Therefore, optimizations in the device attachment algorithm based on this assumption are allowed.
- The device manager may delay loading a driver bundle until it is needed. For example, a delay could occur when that DRIVER\_ID's match values are cached.
- The results of calls to DriverLocator and DriverSelector methods are not required to be deterministic, and must not be cached by the device manager.
- Thrown exceptions must not be cached. Exceptions are considered transient failures, and the device manager must always retry a method call even if it has thrown an exception on a previous invocation with the same arguments.

### 103.7.5 Driver Bundle Reclamation

The device manager may remove driver bundles it has installed at any time, provided that all the Driver services in that bundle are idle. This recommended practice prevents unused driver bundles from accumulating over time. Removing driver bundles too soon, however, may cause unnecessary installs and associated delays when driver bundles are needed again.

If a device manager implements driver bundle reclamation, the specified matching algorithm is not guaranteed to terminate unless the device manager takes reclamation into account.

For example, assume that a new Device service triggers the attachment algorithm. A driver bundle recommended by a Driver Locator service is loaded. It does not match, so the Device service remains idle. The device manager is eager to reclaim space, and unloads the driver bundle. The disappearance of the Driver service causes the device manager to reattach idle devices. Because it has not kept a record of its previous activities, it tries to reattach the same device, which closes the loop.

On systems where the device manager implements driver bundle reclamation, all refining drivers should be loaded through Driver Locator services. This recommendation is intended to prevent the

device manager from erroneously uninstalling pre-installed driver bundles that cannot later be reinstalled when needed.

The device manager can be updated or restarted. It cannot, however, rely on previously stored information to determine which driver bundles were pre-installed and which were dynamically installed and thus are eligible for removal. The device manager may persistently store cachable information for optimization, but must be able to cold start without any persistent information and still be able to manage an existing connection state, satisfying all of the requirements in this specification.

### 103.7.6 Handling Driver Bundle Updates

It is not straightforward to determine whether a driver bundle is being updated when the UNREGISTER event for a Driver service is received. In order to facilitate this distinction, the device manager should wait for a period of time after the unregistration for one of the following events to occur:

- A BundleEvent.UNINSTALLED event for the driver bundle.
- A ServiceEvent.REGISTERED event for another Driver service registered by the driver bundle.

If the driver bundle is uninstalled, or if neither of the above events are received within the allotted time period, the driver is assumed to be inactive. The appropriate waiting period is implementation-dependent and will vary for different installations. As a general rule, this period should be long enough to allow a driver to be stopped, updated, and restarted under normal conditions, and short enough not to cause unnecessary delays in reattaching devices. The actual time should be configurable.

### 103.7.7 Simultaneous Device Service and Driver Service Registration

The device attachment algorithm may discover new driver bundles that were installed outside its direct control, which requires executing the device attachment algorithm recursively. However, in this case, the appearance of the new driver bundles should be queued until completion of the current device attachment algorithm.

Only one device attachment algorithm may be in progress at any moment in time.

The following example sequence illustrates this process when a Driver service is registered:

- Collect the set of all idle devices.
- Apply the device attachment algorithm to each device in the set.
- If no Driver services were registered during the execution of the device attachment algorithm, processing terminates.
- Otherwise, restart this process.

## 103.8 Security

The device manager is the only privileged bundle in the Device Access specification and requires the `org.osgi.framework.AdminPermission` with the `LIFECYCLE` action to install and uninstall driver bundles.

The device manager itself should be free from any knowledge of policies and should not actively set bundle permissions. Rather, if permissions must be set, it is up to the Management Agent to listen to synchronous bundle events and set the appropriate permissions.

Driver Locator services can trigger the download of any bundle, because they deliver the content of a bundle to the privileged device manager and could potentially insert a Trojan horse into the environment. Therefore, Driver Locator bundles need the `ServicePermission[DriverLocator, REGISTER]`

to register Driver Locator services, and the operator should exercise prudence in assigning this ServicePermission.

Bundles with Driver Selector services only require ServicePermission[DriverSelector, REGISTER] to register the DriverSelector service. The Driver Selector service can play a crucial role in the selection of a suitable Driver service, but it has no means to define a specific bundle itself.

## 103.9 org.osgi.service.device

Device Access Package Version 1.1.

Bundles wishing to use this package must list the package in the Import-Package header of the bundle's manifest. This package has two types of users: the consumers that use the API in this package and the providers that implement the API in this package.

Example import for consumers using the API in this package:

```
Import-Package: org.osgi.service.device; version="[1.1,2.0)"
```

Example import for providers implementing the API in this package:

```
Import-Package: org.osgi.service.device; version="[1.1,1.2)"
```

### 103.9.1 Summary

- Constants - This interface defines standard names for property keys associated with Device and Driver services.
- Device - Interface for identifying device services.
- Driver - A Driver service object must be registered by each Driver bundle wishing to attach to Device services provided by other drivers.
- DriverLocator - A Driver Locator service can find and load device driver bundles given a property set.
- DriverSelector - When the device manager detects a new Device service, it calls all registered Driver services to determine if anyone matches the Device service.
- Match - Instances of Match are used in the DriverSelector.select(ServiceReference, Match[]) method to identify Driver services matching a Device service.

### 103.9.2 public interface Constants

This interface defines standard names for property keys associated with Device and Driver services.

The values associated with these keys are of type java.lang.String, unless otherwise stated.

*See Also* Device, Driver

*Since* 1.1

*No Implement* Consumers of this API must not implement this interface

#### 103.9.2.1 public static final String DEVICE\_CATEGORY = "DEVICE\_CATEGORY"

Property (named "DEVICE\_CATEGORY") containing a human readable description of the device categories implemented by a device. This property is of type String[]

Services registered with this property will be treated as devices and discovered by the device manager

#### 103.9.2.2 public static final String DEVICE\_DESCRIPTION = "DEVICE\_DESCRIPTION"

Property (named "DEVICE\_DESCRIPTION") containing a human readable string describing the actual hardware device.

**103.9.2.3**      **public static final String DEVICE\_SERIAL = "DEVICE\_SERIAL"**  
 Property (named "DEVICE\_SERIAL") specifying a device's serial number.

**103.9.2.4**      **public static final String DRIVER\_ID = "DRIVER\_ID"**  
 Property (named "DRIVER\_ID") identifying a driver.  
 A DRIVER\_ID should start with the reversed domain name of the company that implemented the driver (e.g., com.acme), and must meet the following requirements:

- It must be independent of the location from where it is obtained.
- It must be independent of the DriverLocator service that downloaded it.
- It must be unique.
- It must be different for different revisions of the same driver.

This property is mandatory, i.e., every Driver service must be registered with it.

### **103.9.3**      **public interface Device**

Interface for identifying device services.

A service must implement this interface or use the Constants.DEVICE\_CATEGORY registration property to indicate that it is a device. Any services implementing this interface or registered with the DEVICE\_CATEGORY property will be discovered by the device manager.

Device services implementing this interface give the device manager the opportunity to indicate to the device that no drivers were found that could (further) refine it. In this case, the device manager calls the noDriverFound() method on the Device object.

Specialized device implementations will extend this interface by adding methods appropriate to their device category to it.

*See Also* Driver

*Concurrency* Thread-safe

**103.9.3.1**      **public static final int MATCH\_NONE = 0**  
 Return value from Driver.match(ServiceReference) indicating that the driver cannot refine the device presented to it by the device manager. The value is zero.

**103.9.3.2**      **public void noDriverFound()**

- Indicates to this Device object that the device manager has failed to attach any drivers to it.

If this Device object can be configured differently, the driver that registered this Device object may unregister it and register a different Device service instead.

### **103.9.4**      **public interface Driver**

A Driver service object must be registered by each Driver bundle wishing to attach to Device services provided by other drivers. For each newly discovered Device object, the device manager enters a bidding phase. The Driver object whose match(ServiceReference) method bids the highest for a particular Device object will be instructed by the device manager to attach to the Device object.

*See Also* Device, DriverLocator

*Concurrency* Thread-safe

**103.9.4.1**      **public String attach(ServiceReference reference) throws Exception**  
*reference* the ServiceReference object of the device to attach to

- Attaches this Driver service to the Device service represented by the given ServiceReference object.

A return value of null indicates that this Driver service has successfully attached to the given Device service. If this Driver service is unable to attach to the given Device service, but knows of a more suitable Driver service, it must return the DRIVER\_ID of that Driver service. This allows for the implementation of referring drivers whose only purpose is to refer to other drivers capable of handling a given Device service.

After having attached to the Device service, this driver may register the underlying device as a new service exposing driver-specific functionality.

This method is called by the device manager.

*Returns* null if this Driver service has successfully attached to the given Device service, or the DRIVER\_ID of a more suitable driver

*Throws* Exception— if the driver cannot attach to the given device and does not know of a more suitable driver

#### 103.9.4.2 **public int match(ServiceReference reference) throws Exception**

*reference* the ServiceReference object of the device to match

- Checks whether this Driver service can be attached to the Device service. The Device service is represented by the given ServiceReference and returns a value indicating how well this driver can support the given Device service, or Device.MATCH\_NONE if it cannot support the given Device service at all.

The return value must be one of the possible match values defined in the device category definition for the given Device service, or Device.MATCH\_NONE if the category of the Device service is not recognized.

In order to make its decision, this Driver service may examine the properties associated with the given Device service, or may get the referenced service object (representing the actual physical device) to talk to it, as long as it ungets the service and returns the physical device to a normal state before this method returns.

A Driver service must always return the same match code whenever it is presented with the same Device service.

The match function is called by the device manager during the matching process.

*Returns* value indicating how well this driver can support the given Device service, or Device.MATCH\_NONE if it cannot support the Device service at all

*Throws* Exception— if this Driver service cannot examine the Device service

#### 103.9.5 **public interface DriverLocator**

A Driver Locator service can find and load device driver bundles given a property set. Each driver is represented by a unique DRIVER\_ID.

Driver Locator services provide the mechanism for dynamically downloading new device driver bundles into an OSGi environment. They are supplied by providers and encapsulate all provider-specific details related to the location and acquisition of driver bundles.

*See Also* Driver

*Concurrency* Thread-safe

##### 103.9.5.1 **public String[] findDrivers(Dictionary props)**

*props* the properties of the device for which a driver is sought

- Returns an array of DRIVER\_ID strings of drivers capable of attaching to a device with the given properties.

The property keys in the specified Dictionary objects are case-insensitive.



*Returns* array of driver DRIVER\_ID strings of drivers capable of attaching to a Device service with the given properties, or null if this Driver Locator service does not know of any such drivers

### 103.9.5.2 **public InputStream loadDriver(String id) throws IOException**

*id* the DRIVER\_ID of the driver that needs to be installed.

- Get an InputStream from which the driver bundle providing a driver with the giving DRIVER\_ID can be installed.

*Returns* An InputStream object from which the driver bundle can be installed or null if the driver with the given ID cannot be located

*Throws* IOException– the input stream for the bundle cannot be created

## 103.9.6 **public interface DriverSelector**

When the device manager detects a new Device service, it calls all registered Driver services to determine if anyone matches the Device service. If at least one Driver service matches, the device manager must choose one. If there is a Driver Selector service registered with the Framework, the device manager will ask it to make the selection. If there is no Driver Selector service, or if it returns an invalid result, or throws an Exception, the device manager uses the default selection strategy.

*Since* 1.1

*Concurrency* Thread-safe

### 103.9.6.1 **public static final int SELECT\_NONE = -1**

Return value from DriverSelector.select, if no Driver service should be attached to the Device service. The value is -1.

### 103.9.6.2 **public int select(ServiceReference reference, Match[] matches)**

*reference* the ServiceReference object of the Device service.

*matches* the array of all non-zero matches.

- Select one of the matching Driver services. The device manager calls this method if there is at least one driver bidding for a device. Only Driver services that have responded with nonzero (not Device.MATCH\_NONE) match values will be included in the list.

*Returns* index into the array of Match objects, or SELECT\_NONE if no Driver service should be attached

## 103.9.7 **public interface Match**

Instances of Match are used in the DriverSelector.select(ServiceReference, Match[]) method to identify Driver services matching a Device service.

*See Also* DriverSelector

*Since* 1.1

*Concurrency* Thread-safe

*No Implement* Consumers of this API must not implement this interface

### 103.9.7.1 **public ServiceReference getDriver()**

- Return the reference to a Driver service.

*Returns* ServiceReference object to a Driver service.

### 103.9.7.2 **public int getMatchValue()**

- Return the match value of this object.

*Returns* the match value returned by this Driver service.

## 103.10 References

- [1] *Java Communications API*  
<http://www.oracle.com/technetwork/java/index-jsp-141752.html>
- [2] *USB Specification*  
<http://www.usb.org>
- [3] *Universal Plug and Play*  
<http://www.upnp.org>
- [4] *Jini, Service Discovery and Usage*  
<http://en.wikipedia.org/wiki/Jini>

# 104 Configuration Admin Service Specification

## Version 1.5

### 104.1 Introduction

The Configuration Admin service is an important aspect of the deployment of an OSGi framework. It allows an Operator to configure deployed bundles. Configuring is the process of defining the configuration data for bundles and assuring that those bundles receive that data when they are active in the OSGi framework.

Figure 104.1 Configuration Admin Service Overview

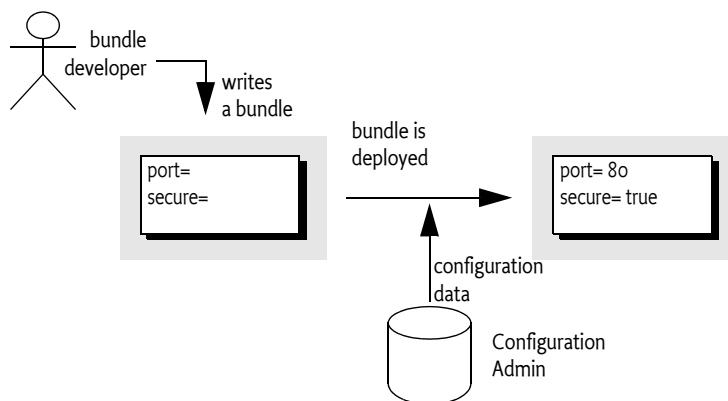

#### 104.1.1 Essentials

The following requirements and patterns are associated with the Configuration Admin service specification:

- *Local Configuration* - The Configuration Admin service must support bundles that have their own user interface to change their configurations.
- *Reflection* - The Configuration Admin service must be able to deduce the names and types of the needed configuration data.
- *Legacy* - The Configuration Admin service must support configuration data of existing entities (such as devices).
- *Object Oriented* - The Configuration Admin service must support the creation and deletion of instances of configuration information so that a bundle can create the appropriate number of services under the control of the Configuration Admin service.
- *Embedded Devices* - The Configuration Admin service must be deployable on a wide range of platforms. This requirement means that the interface should not assume file storage on the platform. The choice to use file storage should be left to the implementation of the Configuration Admin service.

- *Remote versus Local Management* - The Configuration Admin service must allow for a remotely managed OSGi framework, and must not assume that configuration information is stored locally. Nor should it assume that the Configuration Admin service is always done remotely. Both implementation approaches should be viable.
- *Availability* - The OSGi environment is a dynamic environment that must run continuously (24/7/365). Configuration updates must happen dynamically and should not require restarting of the system or bundles.
- *Immediate Response* - Changes in configuration should be reflected immediately.
- *Execution Environment* - The Configuration Admin service will not require more than an environment that fulfills the minimal execution requirements.
- *Communications* - The Configuration Admin service should not assume "always-on" connectivity, so the API is also applicable for mobile applications in cars, phones, or boats.
- *Extendability* - The Configuration Admin service should expose the process of configuration to other bundles. This exposure should at a minimum encompass initiating an update, removing certain configuration properties, adding properties, and modifying the value of properties potentially based on existing property or service values.
- *Complexity Trade-offs* - Bundles in need of configuration data should have a simple way of obtaining it. Most bundles have this need and the code to accept this data. Additionally, updates should be simple from the perspective of the receiver.

Trade-offs in simplicity should be made at the expense of the bundle implementing the Configuration Admin service and in favor of bundles that need configuration information. The reason for this choice is that normal bundles will outnumber Configuration Admin bundles.

- *Regions* - It should be possible to create groups of bundles and a manager in a single system that share configuration data that is not accessible outside the region.
- *Shared Information* - It should be possible to share configuration data between bundles.

## 104.1.2

### Entities

- *Configuration information* - The information needed by a bundle before it can provide its intended functionality.
- *Configuration dictionary* - The configuration information when it is passed to the target service. It consists of a Dictionary object with a number of properties and identifiers.
- *Configuring Bundle* - A bundle that modifies the configuration information through the Configuration Admin service. This bundle is either a management bundle or the bundle for which the configuration information is intended.
- *Configuration Target* - The target service that will receive the configuration information. For services, there are two types of targets: ManagedServiceFactory or ManagedService objects.
- *Configuration Admin Service* - This service is responsible for supplying configuration target bundles with their configuration information. It maintains a database with configuration information, keyed on the service.pid of configuration target services. These services receive their configuration dictionary/dictionaries when they are registered with the Framework. Configurations can be modified or extended using Configuration Plugin services before they reach the target bundle.
- *Managed Service* - A Managed Service represents a client of the Configuration Admin service, and is thus a configuration target. Bundles should register a Managed Service to receive the configuration data from the Configuration Admin service. A Managed Service adds one or more unique service.pid service properties as a primary key for the configuration information.
- *Managed Service Factory* - A Managed Service Factory can receive a number of configuration dictionaries from the Configuration Admin service, and is thus also a configuration target service. It should register with one or more service.pid strings and receives zero or more configuration dictionaries. Each dictionary has its own PID that is distinct from the factory PID.

- *Configuration Object* - Implements the Configuration interface and contains the configuration dictionary for a Managed Service or one of the configuration dictionaries for a Managed Service Factory. These objects are manipulated by configuring bundles.
- *Configuration Plugin Services* - Configuration Plugin services are called before the configuration dictionary is given to the configuration targets. The plug-in can modify the configuration dictionary, which is passed to the Configuration Target.

Figure 104.2 Overall Service Diagram

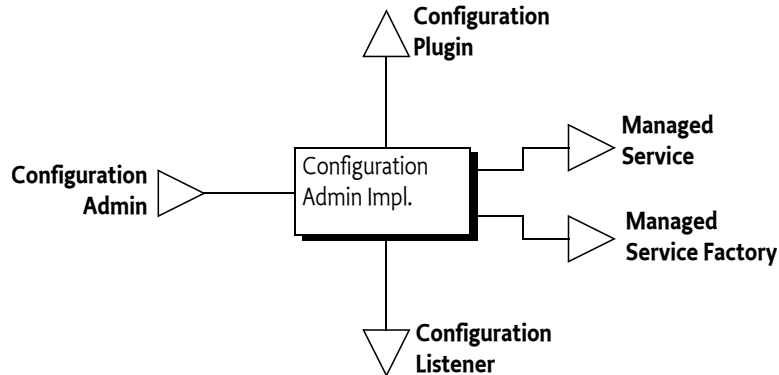

### 104.1.3 Synopsis

This specification is based on the concept of a Configuration Admin service that manages the configuration of an OSGi framework. It maintains a database of Configuration objects, locally or remotely. This service monitors the service registry and provides configuration information to services that are registered with a service.pid property, the Persistent IDENTITY (PID), and implement one of the following interfaces:

- *Managed Service* - A service registered with this interface receives its *configuration dictionary* from the database or receives null when no such configuration exists.
- *Managed Service Factory* - Services registered with this interface can receive several configuration dictionaries when registered. The database contains zero or more configuration dictionaries for this service. Each configuration dictionary is given sequentially to the service.

The database can be manipulated either by the Management Agent or bundles that configure themselves. Other parties can provide Configuration Plugin services. Such services participate in the configuration process. They can inspect the configuration dictionary and modify it before it reaches the target service.

## 104.2 Configuration Targets

One of the more complicated aspects of this specification is the subtle distinction between the ManagedService and ManagedServiceFactory classes. Both receive configuration information from the Configuration Admin service and are treated similarly in most respects. Therefore, this specification refers to *configuration targets* or simply *targets* when the distinction is irrelevant.

The difference between these types is related to the cardinality of the configuration dictionary. A Managed Service is used when an existing entity needs a configuration dictionary. Thus, a one-to-one relationship always exists between the configuration dictionary and the configurable entity in the Managed Service. There can be multiple Managed Service targets registered with the same PID but a Managed Service can only configure a single entity in each given Managed Service.

A Managed Service Factory is used when part of the configuration is to define *how many instances are required* for a given Managed Service Factory. A management bundle can create, modify, and delete any number of instances for a Managed Service Factory through the Configuration Admin service. Each instance is configured by a single Configuration object. Therefore, a Managed Service Factory can have multiple associated Configuration objects.

Figure 104.3

Differentiation of ManagedService and ManagedServiceFactory Classes

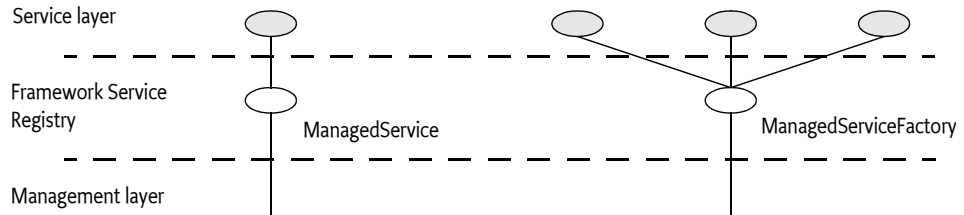

A Configuration target updates the target when the underlying Configuration object is created, updated, or deleted. However, it is not called back when the Configuration Admin service is shutdown or the service is ungotten.

To summarize:

- A *Managed Service* must receive a single configuration dictionary when it is registered or when its configuration is modified.
- A *Managed Service Factory* must receive from zero to  $n$  configuration dictionaries when it registers, depending on the current configuration. The Managed Service Factory is informed of configuration dictionary changes: modifications, creations, and deletions.

## 104.3 The Persistent Identity

A crucial concept in the Configuration Admin service specification is the Persistent IDentity (PID) as defined in the Framework's service layer. Its purpose is to act as a primary key for objects that need a configuration dictionary. The name of the service property for PID is defined in the Framework in `org.osgi.framework.Constants.SERVICE_PID`.

The Configuration Admin service requires the use of one or more PIDs with Managed Service and Managed Service Factory registrations because it associates its configuration data with PIDs.

A service can register with multiple PIDs and PIDs can be shared between multiple targets (both Managed Service and Managed Service Factory targets) to receive the same information. If PIDs are to be shared between Bundles then the location of the Configuration must be a multi-location, see *Location Binding* on page 93.

The Configuration Admin must track the configuration targets on their actual PID. That is, if the `service.pid` service property is modified then the Configuration Admin must treat it as if the service was unregistered and then re-registered with the new PID.

### 104.3.1 PID Syntax

PIDs are intended for use by other bundles, not by people, but sometimes the user is confronted with a PID. For example, when installing an alarm system, the user needs to identify the different components to a wiring application. This type of application exposes the PID to end users.

PIDs should follow the symbolic-name syntax, which uses a very restricted character set. The following sections define some schemes for common cases. These schemes are not required, but bundle developers are urged to use them to achieve consistency.

**104.3.1.1 Local Bundle PIDs**

As a convention, descriptions starting with the bundle identity and a full stop (' \u002E) are reserved for a bundle. As an example, a PID of "65.536" would belong to the bundle with a bundle identity of 65.

**104.3.1.2 Software PIDs**

Configuration target services that are singletons can use a Java package name they own as the PID (the reverse domain name scheme) as long as they do not use characters outside the basic ASCII set. As an example, the PID named com.acme.watchdog would represent a Watchdog service from the ACME company.

**104.3.1.3 Devices**

Devices are usually organized on buses or networks. The identity of a device, such as a unique serial number or an address, is a good component of a PID. The format of the serial number should be the same as that printed on the housing or box, to aid in recognition.

Table 104.1 Schemes for Device-Oriented PID Names

Bus	Example	Format	Description
USB	USB.0123-0002-9909873	idVendor (hex 4) idProduct (hex 4) iSerialNumber (decimal)	Universal Serial Bus. Use the standard device descriptor.
IP	IP.172.16.28.21	IP nr (dotted decimal)	Internet Protocol
802	802-00:60:97:00:9A:56	MAC address with : separators	IEEE 802 MAC address (Token Ring, Ethernet,...)
ONE	ONE.06-00000021E461	Family (hex 2) and serial number including CRC (hex 6)	1-wire bus of Dallas Semiconductor
COM	COM.krups-brewer-12323	serial number or type name of device	Serial ports

**104.3.2 Targeted PIDs**

PIDs are defined as primary keys for the configuration object; any target that uses the PID in its service registration (and has the proper permissions if security is on) will receive the configuration associated with it, regardless of the bundle that registered the target service. Though in general the PID is designed to ignore the bundle, there are a number of cases where the bundle becomes relevant. The most typical case is where a bundle is available in different versions. Each version will request the same PID and will get therefore configured identically.

*Targeted PIDs* are specially formatted PIDs that are interpreted by the Configuration Admin service. Targeted PIDs work both as a normal Managed Service PID and as a Managed Service Factory PID. In the case of factories, the targeted PID is the Factory PID since the other PID is chosen by CM for each instance.

The target PID scopes the applicability of the PID to a limited set of target bundles. The syntax of a target pid is:

```
target-pid ::= PID
              ( '|' symbolic-name ( '|' version ( '|' location )? )? )?
```

Targets never register with a target PID, target PIDs should only be used when creating, getting, or deleting a Configuration through the Configuration Admin service. The target PID is still the primary key of the Configuration and is thus in itself a PID. The distinction is only made when the Configuration Admin must update a target service. Instead of using the non-target PID as the primary key it must first search if there exists a target PID in the Configuration store that matches the requested target PID.

When a target registers and needs to be updated the Configuration Admin must first find the Configuration with the *best matching* PID. It must logically take the requested PID, append it with the bundle symbolic name, the bundle version, and the bundle location. The version must be formatted canonically, that is, according to the `toString()` method of the Version class. The rules for best matching are then as follows:

Look for a Configuration, in the given order, with a key of:

```
<pid>|<bsn>|<version>|<location>
<pid>|<bsn>|<version>
<pid>|<bsn>
<pid>
```

For example:

```
com.example.web.WebConf|com.acme.example|3.2.0|http://www.xyz.com/acme.jar
com.example.web.WebConf|com.acme.example|3.2.0
com.example.web.WebConf|com.acme.example
com.example.web.WebConf
```

If a registered target service has a PID that contains a vertical line (`'\u007c'`) then the value must be taken as is and must not be interpreted as a targeted PID.

The `service.pid` configuration property for a targeted PID configuration must always be set to the targeted PID. That is, if the PID is `com.example.web.WebConf` and the targeted PID `com.example.web.WebConf|com.acme.example|3.2.0` then the property in the Configuration dictionary must be the targeted PID.

If a Configuration with a targeted PID is deleted or a Configuration with a new targeted PID is added then all targets that would be stale must be reevaluated against the new situation and updated accordingly if they are no longer bound against the best matching target PID.

### 104.3.3 Extenders and Targeted PIDs

Extenders like Declarative Services use Configurations but bypass the general Managed Service or Managed Service Factory method. It is the responsibility of these extenders to access the Configurations using the targeted PIDs.

Since getting a Configuration tends to create that Configuration it is necessary for these extenders to use the `listConfigurations(String)` method to find out if a more targeted Configuration exists. There are many ways the extender can find the most targeted PID. For example, the following code gets the most targeted PID for a given bundle.

```
String mostTargeted(String key, String pid, Bundle bundle) throws Exception {
    String bsn = bundle.getSymbolicName();
    Version version = bundle.getVersion();
    String location = bundle.getLocation();
    String f = String.format("(|%1$s=%2$s)|%1$s=%2$s|%3$s" +
        "(|%1$s=%2$s|%3$s|%4$s)|%1$s=%2$s|%3$s|%4$s|%5$s)",
        key, pid, bsn, version, location);

    Configuration[] configurations = cm.listConfigurations(f);
    if (configurations == null)
        return null;

    String largest = null;
    for (Configuration c : configurations) {
        String s = (String) c.getProperties().get(key);
        if ((largest == null) || (largest.length() < s.length()))
```



```

        largest = s;
    }
    return largest;
}

```

## 104.4 The Configuration Object

A Configuration object contains the configuration dictionary, which is a set of properties that configure an aspect of a bundle. A bundle can receive Configuration objects by registering a configuration target service with a PID service property. See *The Persistent Identity* on page 90 for more information about PIDs.

During registration, the Configuration Admin service must detect these configuration target services and hand over their configuration dictionary via a callback. If this configuration dictionary is subsequently modified, the modified dictionary is handed over to the configuration target with the same callback.

The Configuration object is primarily a set of properties that can be updated by a Management Agent, user interfaces on the OSGi framework, or other applications. Configuration changes are first made persistent, and then passed to the target service via a call to the updated method in the `ManagedServiceFactory` or `ManagedService` class.

A Configuration object must be uniquely bound to a Managed Service or Managed Service Factory. This implies that a bundle must not register a Managed Service Factory with a PID that is the same as the PID given to a Managed Service.

### 104.4.1 Location Binding

When a `Configuration` object is created with either `getConfiguration(String)` or `createFactoryConfiguration(String)`, it becomes *bound* to the location of the calling bundle. This location is obtained with the `getBundleLocation()` method.

Location binding is a security feature that assures that only management bundles can modify configuration data, and other bundles can only modify their own configuration data. A Security Exception is thrown if a bundle does not have `ConfigurationPermission[location, CONFIGURE]`.

The two argument versions of `getConfiguration(String,String)` and `createFactoryConfiguration(String,String)` take a location `String` as their second argument. These methods require the correct permission, and they create `Configuration` objects bound to the specified location.

Locations can be specified for a specific Bundle or use *multi-locations*. For a specific location the Configuration location must exactly match the location of the target's Bundle. A multi-location is any location that has the following syntax:

```
multi-location ::= '?' symbolic-name?
```

For example

```
?com.acme
```

The path after the question mark is the *multi-location name*, the multi-location name can be empty if only a question mark is specified. Configurations with a multi-location are dispatched to any target that has *visibility* to the Configuration. The visibility for a given Configuration `c` depends on the following rules:

- *Single-Location* - If `c.location` is not a multi-location then a Bundle only has visibility if the Bundle's location exactly matches `c.location`. In this case there is never a security check.
- *Multi-Location* - If `c.location` is a multi-location (that is, starts with a question mark):

- *Security Off* - The Bundle always has visibility
- *Security On* - The target's Bundle must have ConfigurationPermission[ c.location, TARGET ] as defined by the Bundle's hasPermission method. The resource name of the permission must include the question mark.

The permission matches on the whole name, including any leading ?. The TARGET action is only applicable in the multi-location scenario since the security is not checked for a single-location. There is therefore no point in granting a Bundle a permission with TARGET action for anything but a multi-location (starting with a ?).

It is therefore possible to register services with the same PID from different bundles. If a multi-location is used then each bundle will be evaluated for a corresponding configuration update. If the bundle has visibility then it is updated, otherwise it is not.

If multiple targets must be updated then the order of updating is the ranking order of their services.

If a target loses visibility because the Configuration's location changes then it must immediately be deleted from the perspective of that target. That is, the target must see a deletion (Managed Service Factory) or an update with null (Managed Service). If a configuration target gains visibility then the target must see a new update with the proper configuration dictionary. However, the associated events must not be sent as the underlying Configuration is not actually deleted nor modified.

Changes in the permissions must not initiate a recalculation of the visibility. If the permissions are changed this will not become visible until one of the other events happen that cause a recalculation of the visibility.

If the location is changed then the Configuration Admin must send a CM\_LOCATION\_CHANGED event to signal that the location has changed. It is up to the Configuration Listeners to update their state appropriately.

### 104.4.2 Dynamic Binding

Dynamic binding is available for backward compatibility with earlier versions. It is recommended that management agents explicitly set the location to a ? (a multi-location) to allow multiple bundles to share PIDs and not use the dynamic binding facility. If a management agent uses ?, it must at least have ConfigurationPermission[ ?, CONFIGURE ] when security is on, it is also possible to use ConfigurationPermission[ ?\*, CONFIGURE ] to not limit the management agent. See *Regions* on page 105 for some examples of using the locations in isolation scenarios.

A null location parameter can be used to create Configuration objects that are not yet bound. In this case, the Configuration becomes bound to a specific location the first time that it is compared to a Bundle's location. If a bundle becomes dynamically bound to a Configuration then a CM\_LOCATION\_CHANGED event must be dispatched.

When this *dynamically bound* Bundle is subsequently uninstalled, configurations that are bound to this bundle must be released. That means that for such Configuration object's the bundle location must be set to null again so it can be bound again to another bundle.

### 104.4.3 Configuration Properties

A configuration dictionary contains a set of properties in a Dictionary object. The value of the property must be the same type as the set of Primary Property Types specified in *OSGi Core Release 6* Filter Syntax.

The name or key of a property must always be a String object, and is not case-sensitive during look up, but must preserve the original case. The format of a property name should be:

```
property-name ::= public | private
public       ::= symbolic-name // See General Syntax in Core Framework
private     ::= '.' symbolic-name
```

Properties can be used in other subsystems that have restrictions on the character set that can be used. The symbolic-name production uses a very minimal character set.

Bundles must not use nested lists or arrays, nor must they use mixed types. Using mixed types or nesting makes it impossible to use the meta typing specification. See *Metatype Service Specification* on page 131.

Property values that are collections may have an ordering that must be preserved when persisting the configuration so that later access to the property value will see the preserved ordering of the collection.

#### 104.4.4 Property Propagation

A configuration target should copy the public configuration properties (properties whose name does not start with a '.' or '\u002E') of the Dictionary object argument in `updated(Dictionary)` into the service properties on any resulting service registration.

This propagation allows the development of applications that leverage the Framework service registry more extensively, so compliance with this mechanism is advised.

A configuration target may ignore any configuration properties it does not recognize, or it may change the values of the configuration properties before these properties are registered as service properties. Configuration properties in the Framework service registry are not strictly related to the configuration information.

Bundles that follow this recommendation to propagate public configuration properties can participate in horizontal applications. For example, an application that maintains physical location information in the Framework service registry could find out where a particular device is located in the house or car. This service could use a property dedicated to the physical location and provide functions that leverage this property, such as a graphic user interface that displays these locations.

Bundles performing service registrations on behalf of other bundles (e.g. OSGi Declarative Services) should propagate all public configuration properties and not propagate private configuration properties.

#### 104.4.5 Automatic Properties

The Configuration Admin service must automatically add a number of properties to the configuration dictionary. If these properties are also set by a configuring bundle or a plug-in, they must always be overridden before they are given to the target service, see *Configuration Plugin* on page 108. Therefore, the receiving bundle or plug-in can assume that the following properties are defined by the Configuration Admin service and not by the configuring bundle:

- `service.pid` - Set to the PID of the associated Configuration object. This is the full the targeted PID if a targeted PID is used, see *Targeted PIDs* on page 91.
- `service.factoryPid` - Only set for a Managed Service Factory. It is then set to the PID of the associated Managed Service Factory. This is the full the targeted PID if a targeted PID is used.
- `service.bundleLocation` - Set to the location of the Configuration object. This property can only be used for searching, it may not appear in the configuration dictionary returned from the `getProperties` method due to security reasons, nor may it be used when the target is updated.

Constants for some of these properties can be found in `org.osgi.framework.Constants` and the [ConfigurationAdmin](#) interface. These service properties are all of type String.

#### 104.4.6 Equality

Two different Configuration objects can actually represent the same underlying configuration. This means that a Configuration object must implement the `equals` and `hashCode` methods in such a way that two Configuration objects are equal when their PID is equal.

## 104.5 Managed Service

A Managed Service is used by a bundle that needs one or more configuration dictionaries. It therefore registers the Managed Service with one or more PIDs and is thus associated with one Configuration object in the Configuration Admin service for each registered PID. A bundle can register any number of ManagedService objects, but each must be identified with its own PID or PIDs.

A bundle should use a Managed Service when it needs configuration information for the following:

- *A Singleton* - A single entity in the bundle that needs to be configured.
- *Externally Detected Devices* - Each device that is detected causes a registration of an associated ManagedService object. The PID of this object is related to the identity of the device, such as the address or serial number.

A Managed Service may be registered with more than one PID and therefore be associated with multiple Configuration objects, one for each PID. Using multiple PIDs for a Managed Service is not recommended. For example, when a configuration is deleted for a Managed Service there is no way to identify which PID is associated with the deleted configuration.

### 104.5.1 Singletons

When an object must be instantiated only once, it is called a *singleton*. A singleton requires a single configuration dictionary. Bundles may implement several different types of singletons if necessary.

For example, a Watchdog service could watch the registry for the status and presence of services in the Framework service registry. Only one instance of a Watchdog service is needed, so only a single configuration dictionary is required that contains the polling time and the list of services to watch.

### 104.5.2 Networks

When a device in the external world needs to be represented in the OSGi Environment, it must be detected in some manner. The Configuration Admin service cannot know the identity and the number of instances of the device without assistance. When a device is detected, it still needs configuration information in order to play a useful role.

For example, a 1-Wire network can automatically detect devices that are attached and removed. When it detects a temperature sensor, it could register a Sensor service with the Framework service registry. This Sensor service needs configuration information specifically for that sensor, such as which lamps should be turned on, at what temperature the sensor is triggered, what timer should be started, in what zone it resides, and so on. One bundle could potentially have hundreds of these sensors and actuators, and each needs its own configuration information.

Each of these Sensor services should be registered as a Managed Service with a PID related to the physical sensor (such as the address) to receive configuration information.

Other examples are services discovered on networks with protocols like Jini, UPnP, and Salutation. They can usually be represented in the Framework service registry. A network printer, for example, could be detected via UPnP. Once in the service registry, these services usually require local configuration information. A Printer service needs to be configured for its local role: location, access list, and so on.

This information needs to be available in the Framework service registry whenever that particular Printer service is registered. Therefore, the Configuration Admin service must remember the configuration information for this Printer service.

This type of service should register with the Framework as a Managed Service in order to receive appropriate configuration information.

### 104.5.3 Configuring Managed Services

A bundle that needs configuration information should register one or more ManagedService objects with a PID service property. If it has a default set of properties for its configuration, it may include them as service properties of the Managed Service. These properties may be used as a configuration template when a Configuration object is created for the first time. A Managed Service optionally implements the MetaTypeProvider interface to provide information about the property types. See *Meta Typing* on page 110.

When this registration is detected by the Configuration Admin service, the following steps must occur:

- The configuration stored for the registered PID must be retrieved. If there is a Configuration object for this PID and the configuration is visible for the associated bundle then it is sent to the Managed Service with `updated(Dictionary)`.
- If a Managed Service is registered and no configuration information is available or the configuration is not visible then the Configuration Admin service must call `updated(Dictionary)` with a null parameter.
- If the Configuration Admin service starts *after* a Managed Service is registered, it must call `updated(Dictionary)` on this service as soon as possible according to the prior rules. For this reason, a Managed Service must always get a callback when it registers *and* the Configuration Admin service is started.

Multiple Managed Services can register with the same PID, they are all updated as long as they have visibility to the configuration as defined by the location, see *Location Binding* on page 93.

If the Managed Service is registered with more than one PID and more than one PID has no configuration information available, then `updated(Dictionary)` will be called multiple times with a null parameter.

The `updated(Dictionary)` callback from the Configuration Admin service to the Managed Service must take place asynchronously. This requirement allows the Managed Service to finish its initialization in a synchronized method without interference from the Configuration Admin service callback. Care should be taken not to cause deadlocks by calling the Framework within a synchronized method.

Figure 104.4 Managed Service Configuration Action Diagram

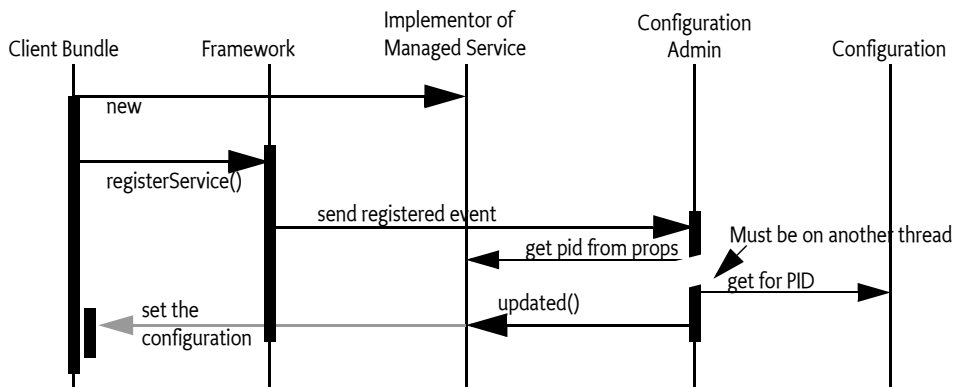

The `updated` method may throw a `ConfigurationException`. This object must describe the problem and what property caused the exception.

### 104.5.4 Race Conditions

When a Managed Service is registered, the default properties may be visible in the service registry for a short period before they are replaced by the properties of the actual configuration dictionary. Care should be taken that this visibility does not cause race conditions for other bundles.

In cases where race conditions could be harmful, the Managed Service must be split into two pieces: an object performing the actual service and a Managed Service. First, the Managed Service is registered, the configuration is received, and the actual service object is registered. In such cases, the use of a Managed Service Factory that performs this function should be considered.

### 104.5.5 Examples of Managed Service

Figure 104.5 shows a Managed Service configuration example. Two services are registered under the ManagedService interface, each with a different PID.

Figure 104.5

*PIDs and External Associations*

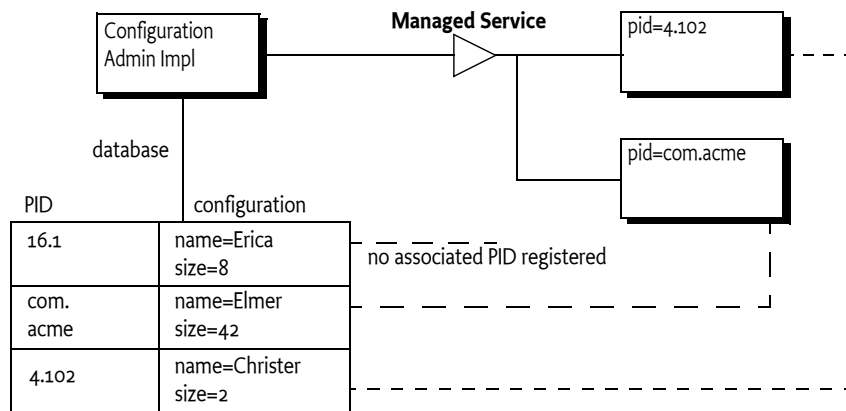

The Configuration Admin service has a database containing a configuration record for each PID. When the Managed Service with `service.pid = com.acme` is registered, the Configuration Admin service will retrieve the properties `name=Elmer` and `size=42` from its database. The properties are stored in a Dictionary object and then given to the Managed Service with the `updated(Dictionary)` method.

#### 104.5.5.1 Configuring A Console Bundle

In this example, a bundle can run a single debugging console over a Telnet connection. It is a singleton, so it uses a ManagedService object to get its configuration information: the port and the network name on which it should register.

```
class SampleManagedService implements ManagedService{
    Dictionary      properties;
    ServiceRegistration registration;
    Console        console;

    public void start(
        BundleContext context ) throws Exception {
        properties = new Hashtable();
        properties.put( Constants.SERVICE_PID,
            "com.acme.console" );

        registration = context.registerService(
```

```

        ManagedService.class.getName(),
        this,
        properties
    );
}

public synchronized void updated( Dictionary np ) {
    if ( np != null ) {
        properties = np;
        properties.put(
            Constants.SERVICE_PID, "com.acme.console" );
    }

    if ( console == null)
        console = new Console();

    int port = ((Integer)properties.get("port"))
        .intValue();

    String network = (String) properties.get("network");
    console.setPort(port, network);
    registration.setProperties(properties);
}
... further methods
}

```

### 104.5.6 Deletion

When a Configuration object for a Managed Service is deleted, the Configuration Admin service must call `updated(Dictionary)` with a null argument on a thread that is different from that on which the `Configuration.delete` was executed. This deletion must send out a Configuration Event `CM_DELETED` asynchronously to any registered Configuration Listener services after the `updated` method is called with a null.

## 104.6 Managed Service Factory

A Managed Service Factory is used when configuration information is needed for a service that can be instantiated multiple times. When a Managed Service Factory is registered with the Framework, the Configuration Admin service consults its database and calls `updated(String,Dictionary)` for each associated and visible Configuration object that matches the PIDs on the registration. It passes the identifier of the Configuration instance, which can be used as a PID, as well as a Dictionary object with the configuration properties.

A Managed Service Factory is useful when the bundle can provide functionality a number of times, each time with different configuration dictionaries. In this situation, the Managed Service Factory acts like a *class* and the Configuration Admin service can use this Managed Service Factory to *instantiate instances* for that *class*.

In the next section, the word *factory* refers to this concept of creating *instances* of a function defined by a bundle that registers a Managed Service Factory.

### 104.6.1 When to Use a Managed Service Factory

A Managed Service Factory should be used when a bundle does not have an internal or external entity associated with the configuration information but can potentially be instantiated multiple times.

### 104.6.1.1 Example Email Fetcher

An email fetcher program displays the number of emails that a user has - a function likely to be required for different users. This function could be viewed as a *class* that needs to be *instantiated* for each user. Each instance requires different parameters, including password, host, protocol, user id, and so on.

An implementation of the Email Fetcher service should register a `ManagedServiceFactory` object. In this way, the Configuration Admin service can define the configuration information for each user separately. The Email Fetcher service will only receive a configuration dictionary for each required instance (user).

### 104.6.1.2 Example Temperature Conversion Service

Assume a bundle has the code to implement a conversion service that receives a temperature and, depending on settings, can turn an actuator on and off. This service would need to be instantiated many times depending on where it is needed. Each instance would require its own configuration information for the following:

- Upper value
- Lower value
- Switch Identification
- ...

Such a conversion service should register a service object under a `ManagedServiceFactory` interface. A configuration program can then use this Managed Service Factory to create instances as needed. For example, this program could use a Graphic User Interface (GUI) to create such a component and configure it.

### 104.6.1.3 Serial Ports

Serial ports cannot always be used by the OSGi Device Access specification implementations. Some environments have no means to identify available serial ports, and a device on a serial port cannot always provide information about its type.

Therefore, each serial port requires a description of the device that is connected. The bundle managing the serial ports would need to instantiate a number of serial ports under the control of the Configuration Admin service, with the appropriate `DEVICE_CATEGORY` property to allow it to participate in the Device Access implementation.

If the bundle cannot detect the available serial ports automatically, it should register a Managed Service Factory. The Configuration Admin service can then, with the help of a configuration program, define configuration information for each available serial port.

## 104.6.2 Registration

Similar to the Managed Service configuration dictionary, the configuration dictionary for a Managed Service Factory is identified by a PID. The Managed Service Factory, however, also has a *factory* PID, which is the PID of the associated Managed Service Factory. It is used to group all Managed Service Factory configuration dictionaries together.

When a Configuration object for a Managed Service Factory is created (`ConfigurationAdmin.createFactoryConfiguration(String,String)` or `createFactoryConfiguration(String)`), a new unique PID is created for this object by the Configuration Admin service. The scheme used for this PID is defined by the Configuration Admin service and is unrelated to the factory PID, which is chosen by the registering bundle.

When the Configuration Admin service detects the registration of a Managed Service Factory, it must find all visible configuration dictionaries for this factory and must then sequentially call `ManagedServiceFactory.updated(String,Dictionary)` for each configuration dictionary. The first ar-



gument is the PID of the Configuration object (the one created by the Configuration Admin service) and the second argument contains the configuration properties.

The Managed Service Factory should then create any artifacts associated with that factory. Using the PID given in the Configuration object, the bundle may register new services (other than a Managed Service) with the Framework, but this is not required. This may be necessary when the PID is useful in contexts other than the Configuration Admin service.

The receiver must *not* register a Managed Service with this PID because this would force two Configuration objects to have the same PID. If a bundle attempts to do this, the Configuration Admin service should log an error and must ignore the registration of the Managed Service.

The Configuration Admin service must guarantee that no race conditions exist between initialization, updates, and deletions.

Figure 104.6 Managed Service Factory Action Diagram

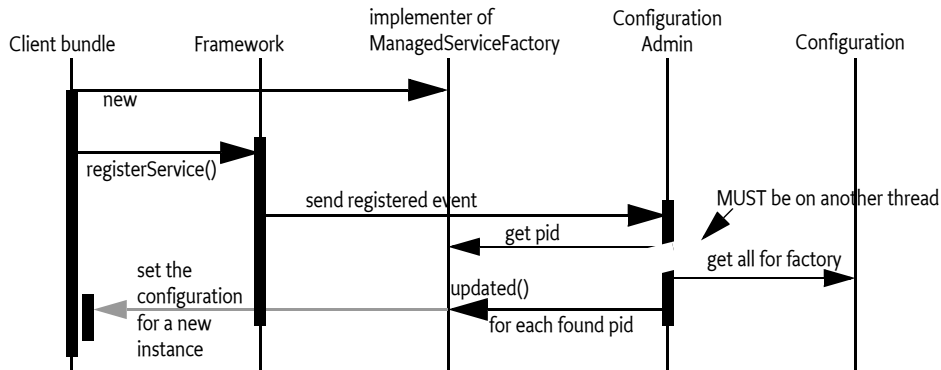

A Managed Service Factory has only one update method: `updated(String,Dictionary)`. This method can be called any number of times as Configuration objects are created or updated.

The Managed Service Factory must detect whether a PID is being used for the first time, in which case it should create a new *instance*, or a subsequent time, in which case it should update an existing instance.

The Configuration Admin service must call `updated(String,Dictionary)` on a thread that is different from the one that executed the registration. This requirement allows an implementation of a Managed Service Factory to use a synchronized method to assure that the callbacks do not interfere with the Managed Service Factory registration.

The `updated(String,Dictionary)` method may throw a `ConfigurationException` object. This object describes the problem and what property caused the problem. These exceptions should be logged by a Configuration Admin service.

Multiple Managed Service Factory services can be registered with the same PID. Each of those services that have visibility to the corresponding configuration will be updated in service ranking order.

### 104.6.3 Deletion

If a configuring bundle deletes an instance of a Managed Service Factory, the `deleted(String)` method is called. The argument is the PID for this instance. The implementation of the Managed Service Factory must remove all information and stop any behavior associated with that PID. If a service was registered for this PID, it should be unregistered.

Deletion will asynchronously send out a Configuration Event `CM_DELETED` to all registered Configuration Listener services.

## 104.6.4 Managed Service Factory Example

Figure 104.7 highlights the differences between a Managed Service and a Managed Service Factory. It shows how a Managed Service Factory implementation receives configuration information that was created before it was registered.

- A bundle implements an EMail Fetcher service. It registers a ManagedServiceFactory object with PID=com.acme.email.
- The Configuration Admin service notices the registration and consults its database. It finds three Configuration objects for which the factory PID is equal to com.acme.email. It must call updated(String,Dictionary) for each of these Configuration objects on the newly registered ManagedServiceFactory object.
- For each configuration dictionary received, the factory should create a new instance of a EMail-Fetcher object, one for erica (PID=16.1), one for anna (PID=16.3), and one for elmer (PID=16.2).
- The EMailFetcher objects are registered under the Topic interface so their results can be viewed by an online display.

If the EMailFetcher object is registered, it may safely use the PID of the Configuration object because the Configuration Admin service must guarantee its suitability for this purpose.

Figure 104.7

Managed Service Factory Example

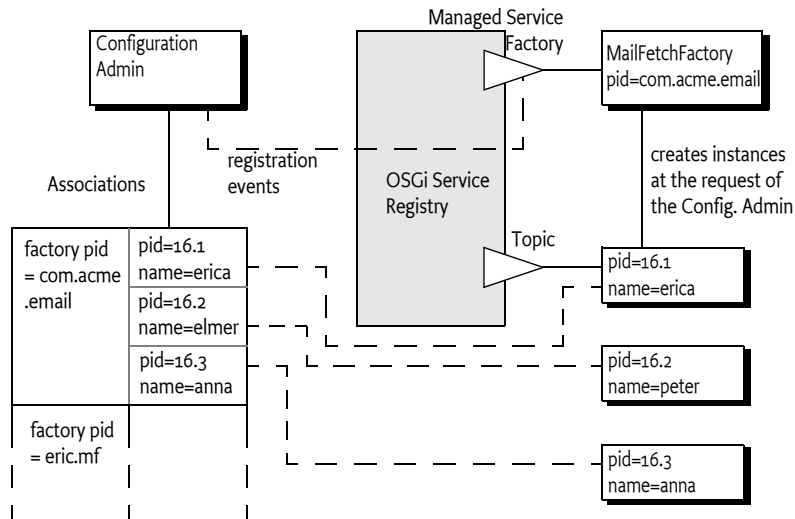

## 104.6.5 Multiple Consoles Example

This example illustrates how multiple consoles, each of which has its own port and interface can run simultaneously. This approach is very similar to the example for the Managed Service, but highlights the difference by allowing multiple consoles to be created.

```
class ExampleFactory implements ManagedServiceFactory{
    Hashtable    consoles = new Hashtable();
    BundleContext context;
    public void start( BundleContext context )
        throws Exception {
        this.context = context;
        Hashtable local = new Hashtable();
        local.put(Constants.SERVICE_PID, "com.acme.console");
        context.registerService(
            ManagedServiceFactory.class.getName(),
```

```

        this,
        local );
    }

    public void updated( String pid, Dictionary config ){
        Console console = (Console) consoles.get(pid);
        if (console == null) {
            console = new Console(context);
            consoles.put(pid, console);
        }

        int port = getInt(config, "port", 2011);
        String network = getString(
            config,
            "network",
            null /*all*/
        );
        console.setPort(port, network);
    }

    public void deleted(String pid) {
        Console console = (Console) consoles.get(pid);
        if (console != null) {
            consoles.remove(pid);
            console.close();
        }
    }
}

```

## 104.7 Configuration Admin Service

The [ConfigurationAdmin](#) interface provides methods to maintain configuration data in an OSGi environment. This configuration information is defined by a number of Configuration objects associated with specific configuration targets. Configuration objects can be created, listed, modified, and deleted through this interface. Either a remote management system or the bundles configuring their own configuration information may perform these operations.

The ConfigurationAdmin interface has methods for creating and accessing Configuration objects for a Managed Service, as well as methods for managing new Configuration objects for a Managed Service Factory.

### 104.7.1 Creating a Managed Service Configuration Object

A bundle can create a new Managed Service Configuration object with `ConfigurationAdmin.getConfiguration`. No create method is offered because doing so could introduce race conditions between different bundles trying to create a Configuration object for the same Managed Service. The `getConfiguration` method must atomically create and persistently store an object if it does not yet exist.

Two variants of this method are:

- [getConfiguration\(String\)](#) - This method is used by a bundle with a given location to configure its *own* ManagedService objects. The argument specifies the PID of the targeted service.
- [getConfiguration\(String,String\)](#) - This method is used by a management bundle to configure *another* bundle. Therefore, this management bundle needs the right permission. The first argument

is the PID and the second argument is the location identifier of the targeted ManagedService object.

All Configuration objects have a method, `getFactoryPid()`, which in this case must return null because the Configuration object is associated with a Managed Service.

Creating a new Configuration object must *not* initiate a callback to the Managed Service updated method until the properties are set in the Configuration with the update method.

### 104.7.2 Creating a Managed Service Factory Configuration Object

The ConfigurationAdmin class provides two methods to create a new instance of a Managed Service Factory:

- `createFactoryConfiguration(String)` - This method is used by a bundle with a given location to configure its own ManagedServiceFactory objects. The argument specifies the PID of the targeted ManagedServiceFactory object. This *factory PID* can be obtained from the returned Configuration object with the `getFactoryPid()` method.
- `createFactoryConfiguration(String,String)` - This method is used by a management bundle to configure another bundle's ManagedServiceFactory object. The first argument is the PID and the second is the location identifier of the targeted ManagedServiceFactory object. The *factory PID* can be obtained from the returned Configuration object with `getFactoryPid` method.

Creating a new factory configuration must *not* initiate a callback to the Managed Service Factory updated method until the properties are set in the Configuration object with the update method.

### 104.7.3 Accessing Existing Configurations

The existing set of Configuration objects can be listed with `listConfigurations(String)`. The argument is a String object with a filter expression. This filter expression has the same syntax as the Framework Filter class. For example:

```
(&(size=42) (service.factoryPid=*osgi*))
```

The Configuration Admin service must only return Configurations that are visible to the calling bundle, see *Location Binding* on page 93.

A single Configuration object is identified with a PID, and can be obtained with `listConfigurations(String)` if it is visible. null is returned in both cases when there are no visible Configuration objects.

The PIDs that are filtered on can be targeted PIDs, see *Targeted PIDs* on page 91.

### 104.7.4 Updating a Configuration

The process of updating a Configuration object is the same for Managed Services and Managed Service Factories. First, `listConfigurations(String)` or `getConfiguration(String)` should be used to get a Configuration object. The properties can be obtained with `Configuration.getProperties`. When no update has occurred since this object was created, `getProperties` returns null.

New properties can be set by calling `Configuration.update`. The Configuration Admin service must first store the configuration information and then call all configuration targets that have visibility with the updated method: either the `ManagedService.updated(Dictionary)` or `ManagedServiceFactory.updated(String,Dictionary)` method. If a target service is not registered, the fresh configuration information must be given to the target when the configuration target service registers and it has visibility. Each update of the Configuration properties must update a counter in the Configuration object after the data has been persisted but before the target(s) have been updated and any events are sent out. This counter is available from the `getChangeCount()` method.

The update method calls in Configuration objects are not executed synchronously with the related target services updated method. The updated method must be called asynchronously. The Configu-

ration Admin service, however, must have updated the persistent storage before the update method returns.

The update method must also asynchronously send out a Configuration Event `CM_UPDATED` to all registered Configuration Listeners.

### 104.7.5 Using Multi-Locations

Sharing configuration between different bundles can be done using multi-locations, see *Location Binding* on page 93. A multi-location for a Configuration enables this Configuration to be delivered to any bundle that has visibility to that configuration. It is also possible that Bundles are interested in multiple PIDs for one target service, for this reason they can register multiple PIDs for one service.

For example, a number of bundles require access to the URL of a remote host, associated with the PID `com.acme.host`. A manager, aware that this PID is used by different bundles, would need to specify a location for the Configuration that allows delivery to any bundle. A multi-location, any location starting with a question mark achieves this. The part after the question mark has only use if the system runs with security, it allows the implementation of regions, see *Regions* on page 105. In this example a single question mark is used because any Bundle can receive this Configuration. The manager's code could look like:

```
Configuration c = admin.getConfiguration("com.acme.host", "?" );
Hashtable ht = new Hashtable();
ht.put( "host", hostURL);
c.update(ht);
```

A Bundle interested in the host configuration would register a Managed Service with the following properties:

```
service.pid = [ "com.acme.host", "com.acme.system"]
```

The Bundle would be called back for both the `com.acme.host` and `com.acme.system` PID and must therefore discriminate between these two cases. This Managed Service therefore would have a callback like:

```
volatile URL url;
public void updated( Dictionary d ) {
    if ( d.get("service.pid").equals("com.acme.host"))
        this.url = new URL( d.get("host"));
    if ( d.get("service.pid").equals("com.acme.system"))
        ....
}
```

### 104.7.6 Regions

In certain cases it is necessary to isolate bundles from each other. This will require that the configuration can be separated in *regions*. Each region can then be configured by a separate manager that is only allowed to manage bundles in its own region. Bundles can then only see configurations from their own region. Such a region based system can only be achieved with Java security as this is the only way to place bundles in a sandbox. This section describes how the Configuration's location binding can be used to implement regions if Java security is active.

Regions are groups of bundles that share location information among each other but are not willing to share this information with others. Using the multi-locations, see *Location Binding* on page 93, and security it is possible to limit access to a Configuration by using a location name. A Bundle can only receive a Configuration when it has `ConfigurationPermission` [`location name`, `TARGET`]. It is therefore possible to create region by choosing a region name for the location. A management agent

then requires `ConfigurationPermission` [`?region-name, CONFIGURE` ] and a Bundle in the region requires `ConfigurationPermission` [`?region-name, TARGET` ].

To implement regions, the management agent is required to use multi-locations; without the question mark a Configuration is only visible to a Bundle that has the exact location of the Configuration. With a multi-location, the Configuration is delivered to any bundle that has the appropriate permission. Therefore, if regions are used, no manager should have `ConfigurationPermission` [`*`, `CONFIGURE` ] because it would be able to configure anybody. This permission would enable the manager to set the location to any region or set the location to null. All managers must be restricted to a permission like `ConfigurationPermission` [`?com.acme.region.*, CONFIGURE`]. The resource name for a Configuration Permission uses substring matching as in the OSGi Filter, this facility can be used to simplify the administrative setup and implement more complex sharing schemes.

For example, a management agent works for the region `com.acme`. It has the following permission:

```
ConfigurationPermission [?com.acme.*, CONFIGURE]
```

The manager requires multi-location updates for `com.acme.*` (the last full stop is required in this wildcarding). For the `CONFIGURE` action the question mark must be specified in the resource name. The bundles in the region have the permission:

```
ConfigurationPermission ["?com.acme.alpha", TARGET]
```

The question mark must be specified for the `TARGET` permission. A management agent that needs to configure Bundles in a region must then do this as follows:

```
Configuration c = admin.getConfiguration("com.acme.host", "?com.acme.alpha" );
Hashtable ht = new Hashtable();
ht.put( "host", hostURL);
c.update(ht);
```

Another, similar, example with two regions:

- system
- application

There is only one manager that manages all bundles. Its permissions look like:

```
ConfigurationPermission [?system, CONFIGURE]
ConfigurationPermission [?application, CONFIGURE]
```

A Bundle in the application region can have the following permissions:

```
ConfigurationPermission [?application, TARGET]
```

This managed bundle therefore has only visibility to configurations in the application region.

## 104.7.7 Deletion

A Configuration object that is no longer needed can be deleted with `Configuration.delete`, which removes the Configuration object from the database. The database must be updated before the target service's updated or deleted method is called. Only services that have received the configuration dictionary before must be called.

If the target service is a Managed Service Factory, the factory is informed of the deleted Configuration object by a call to `ManagedServiceFactory.deleted(String)` method. It should then remove the associated *instance*. The `ManagedServiceFactory.deleted(String)` call must be done asynchronously with respect to `Configuration.delete()`.

When a Configuration object of a Managed Service is deleted, `ManagedService.updated` is called with null for the properties argument. This method may be used for clean-up, to revert to default values, or to unregister a service. This method is called asynchronously from the delete method.

The update method must also asynchronously send out a Configuration Event `CM_DELETED` to all registered Configuration Listeners.

### 104.7.8 Updating a Bundle's Own Configuration

The Configuration Admin service specification does not distinguish between updates via a Management Agent and a bundle updating its own configuration information (as defined by its location). Even if a bundle updates its own configuration information, the Configuration Admin service must callback the associated target service's `updated` method.

As a rule, to update its own configuration, a bundle's user interface should *only* update the configuration information and never its internal structures directly. This rule has the advantage that the events, from the bundle implementation's perspective, appear similar for internal updates, remote management updates, and initialization.

## 104.8 Configuration Events

Configuration Admin can update interested parties of changes in its repository. The model is based on the white board pattern where Configuration Listener services are registered with the service registry.

There are two types of Configuration Listener services:

- `ConfigurationListener` - The default Configuration Listener receives events asynchronously from the method that initiated the event and on another thread.
- `SynchronousConfigurationListener` - A Synchronous Configuration Listener is guaranteed to be called on the same thread as the method call that initiated the event.

The Configuration Listener service will receive `ConfigurationEvent` objects if important changes take place. The Configuration Admin service must call the `configurationEvent(ConfigurationEvent)` method with such an event. Configuration Events must be delivered in order for each listener as they are generated. The way events must be delivered is the same as described in *Delivering Events of OSGi Core Release 6*.

The `ConfigurationEvent` object carries a factory PID (`getFactoryPid()`) and a PID (`getPid()`). If the factory PID is null, the event is related to a Managed Service Configuration object, else the event is related to a Managed Service Factory Configuration object.

The `ConfigurationEvent` object can deliver the following events from the `getType()` method:

- `CM_DELETED` - The Configuration object is deleted.
- `CM_UPDATED` - The Configuration object is updated.
- `CM_LOCATION_CHANGED` - The location of the Configuration object changed.

The Configuration Event also carries the `ServiceReference` object of the Configuration Admin service that generated the event.

### 104.8.1 Event Admin Service and Configuration Change Events

Configuration events must be delivered asynchronously by the Configuration Admin implementation, if present. The topic of a configuration event must be:

```
org/osgi/service/cm/ConfigurationEvent/<eventtype>
```

The <event type> can be any of the following:

CM\_DELETED  
CM\_UPDATED  
CM\_LOCATION\_CHANGED

The properties of a configuration event are:

- `cm.factoryPid` - (String) The factory PID of the associated Configuration object, if the target is a Managed Service Factory. Otherwise not set.
- `cm.pid` - (String) The PID of the associated Configuration object.
- `service` - (ServiceReference) The Service Reference of the Configuration Admin service.
- `service.id` - (Long) The Configuration Admin service's ID.
- `service.objectClass` - (String[]) The Configuration Admin service's object class (which must include `org.osgi.service.cm.ConfigurationAdmin`)
- `service.pid` - (String) The Configuration Admin service's persistent identity, if set.

## 104.9 Configuration Plugin

The Configuration Admin service allows third-party applications to participate in the configuration process. Bundles that register a service object under a `ConfigurationPlugin` interface can process the configuration dictionary just before it reaches the configuration target service.

Plug-ins allow sufficiently privileged bundles to intercept configuration dictionaries just *before* they must be passed to the intended Managed Service or Managed Service Factory but *after* the properties are stored. The changes the plug-in makes are dynamic and must not be stored. The plug-in must only be called when an update takes place while it is registered and there is a valid dictionary. The plug-in is not called when a configuration is deleted.

The `ConfigurationPlugin` interface has only one method: `modifyConfiguration(ServiceReference,Dictionary)`. This method inspects or modifies configuration data.

All plug-ins in the service registry must be traversed and called before the properties are passed to the configuration target service. Each Configuration Plugin object gets a chance to inspect the existing data, look at the target object, which can be a `ManagedService` object or a `ManagedServiceFactory` object, and modify the properties of the configuration dictionary. The changes made by a plug-in must be visible to plugins that are called later.

`ConfigurationPlugin` objects should not modify properties that belong to the configuration properties of the target service unless the implications are understood. This functionality is mainly intended to provide functions that leverage the Framework service registry. The changes made by the plug-in should normally not be validated. However, the Configuration Admin must ignore changes to the automatic properties as described in *Automatic Properties* on page 95.

For example, a Configuration Plugin service may add a physical location property to a service. This property can be leveraged by applications that want to know where a service is physically located. This scenario could be carried out without any further support of the service itself, except for the general requirement that the service should propagate the public properties it receives from the Configuration Admin service to the service registry.



Figure 104.8 Order of Configuration Plugin Services

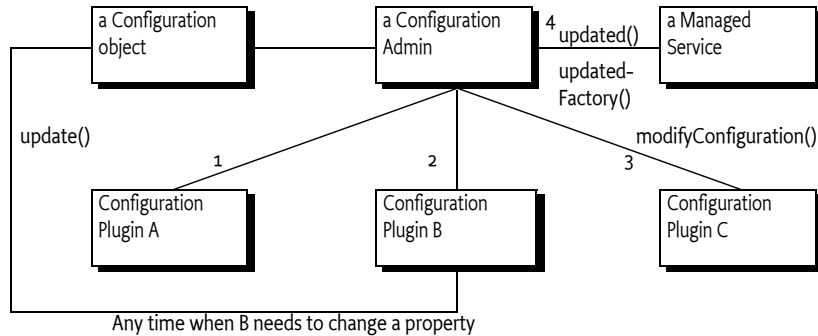

### 104.9.1 Limiting The Targets

A ConfigurationPlugin object may optionally specify a `cm.target` registration property. This value is the PID of the configuration target whose configuration updates the ConfigurationPlugin object wants to intercept.

The ConfigurationPlugin object must then only be called with updates for the configuration target service with the specified PID. For a factory target service, the factory PID is used and the plugin will see all instances of the factory. Omitting the `cm.target` registration property means that it is called for *all* configuration updates.

### 104.9.2 Example of Property Expansion

Consider a Managed Service that has a configuration property `service.to` with the value (`objectclass=com.acme.Alarm`). When the Configuration Admin service sets this property on the target service, a ConfigurationPlugin object may replace the (`objectclass=com.acme.Alarm`) filter with an array of existing alarm systems' PIDs as follows:

```
ID "service.to=[32434, 232, 12421, 1212]"
```

A new Alarm Service with `service.pid=343` is registered, requiring that the list of the target service be updated. The bundle which registered the Configuration Plugin service, therefore, wants to set the `service.to` registration property on the target service. It does *not* do this by calling `ManagedService.updated` directly for several reasons:

- In a securely configured system, it should not have the permission to make this call or even obtain the target service.
- It could get into race conditions with the Configuration Admin service if it had the permissions in the previous bullet. Both services would compete for access simultaneously.

Instead, it must get the Configuration object from the Configuration Admin service and call the `update` method on it.

The Configuration Admin service must schedule a new update cycle on another thread, and sometime in the future must call `ConfigurationPlugin.modifyProperties`. The ConfigurationPlugin object could then set the `service.to` property to [`32434,232,12421,1212, 343`]. After that, the Configuration Admin service must call `updated` on the target service with the new `service.to` list.

### 104.9.3 Configuration Data Modifications

Modifications to the configuration dictionary are still under the control of the Configuration Admin service, which must determine whether to accept the changes, hide critical variables, or deny the changes for other reasons.

The ConfigurationPlugin interface must also allow plugins to detect configuration updates to the service via the callback. This ability allows them to synchronize the configuration updates with transient information.

#### 104.9.4 Forcing a Callback

If a bundle needs to force a Configuration Plugin service to be called again, it must fetch the appropriate Configuration object from the Configuration Admin service and call the update() method (the no parameter version) on this object. This call forces an update with the current configuration dictionary so that all applicable plug-ins get called again.

#### 104.9.5 Calling Order

The order in which the ConfigurationPlugin objects are called must depend on the service.cmRanking configuration property of the ConfigurationPlugin object. Table 104.2 shows the usage of the service.cmRanking property for the order of calling the Configuration Plugin services.

Table 104.2 *service.cmRanking Usage For Ordering*

<b>service.cmRanking value</b>	<b>Description</b>
< 0	The Configuration Plugin service should not modify properties and must be called before any modifications are made.
>= 0 && <= 1000	The Configuration Plugin service modifies the configuration data. The calling order should be based on the value of the service.cmRanking property.
> 1000	The Configuration Plugin service should not modify data and is called after all modifications are made.

## 104.10 Meta Typing

This section discusses how the Metatype specification is used in the context of a Configuration Admin service.

When a Managed Service or Managed Service Factory is registered, the service object may also implement the MetaTypeProvider interface.

If the Managed Service or Managed Service Factory object implements the MetaTypeProvider interface, a management bundle may assume that the associated ObjectClassDefinition object can be used to configure the service.

The ObjectClassDefinition and AttributeDefinition objects contain sufficient information to automatically build simple user interfaces. They can also be used to augment dedicated interfaces with accurate validations.

When the Metatype specification is used, care should be taken to match the capabilities of the metatype package to the capabilities of the Configuration Admin service specification. Specifically:

- The metatype specification cannot describe nested arrays and lists or arrays/lists of mixed type.

This specification does not address how the metatype is made available to a management system due to the many open issues regarding remote management.

## 104.11 Security

### 104.11.1 Configuration Permission

Every bundle has the implicit right to receive and configure configurations with a location that exactly matches the Bundle's location or that is null. For all other situations the Configuration Admin must verify that the configuring and to be updated bundles have a Configuration Permission that matches the Configuration's location.

The resource name of this permission maps to the location of the Configuration, the location can control the visibility of a Configuration for a bundle. The resource name is compared with the actual configuration location using the OSGi Filter sub-string matching. The question mark for multi-locations is part of the given resource name. The Configure Permission has the following actions:

- **CONFIGURE** - Can manage matching configurations
- **TARGET** - Can be updated with a matching configuration

To be able to set the location to null requires a ConfigurationPermission[\*,**CONFIGURE**].

It is possible to deny bundles the use of multi-locations by using Conditional Permission Admin's deny model.

### 104.11.2 Permissions Summary

Configuration Admin service security is implemented using Service Permission and Configuration Permission. The following table summarizes the permissions needed by the Configuration Admin bundle itself, as well as the typical permissions needed by the bundles with which it interacts.

Configuration Admin:

```
ServicePermission[ ..ConfigurationAdmin, REGISTER]
ServicePermission[ ..ManagedService, GET ]
ServicePermission[ ..ManagedServiceFactory, GET ]
ServicePermission[ ..ConfigurationPlugin, GET ]
ConfigurationPermission[ *, CONFIGURE ]
AdminPermission[ *, METADATA ]
```

Managed Service:

```
ServicePermission[ ..ConfigurationAdmin, GET]
ServicePermission[ ..ManagedService, REGISTER ]
ConfigurationPermission[ ... , TARGET ]
```

Managed Service Factory:

```
ServicePermission[ ..ConfigurationAdmin, GET]
ServicePermission[ ..ManagedServiceFactory, REGISTER ]
ConfigurationPermission[ ... , TARGET ]
```

Configuration Plugin:

```
ServicePermission[ ..ConfigurationPlugin, REGISTER ]
```

Configuration Listener:

```
ServicePermission[ ..ConfigurationListener, REGISTER ]
```

The Configuration Admin service must have ServicePermission[ ConfigurationAdmin, REGISTER]. It will also be the only bundle that needs the ServicePermission[ManagedService | ManagedServiceFactory | ConfigurationPlugin, GET]. No other bundle should be allowed to

have GET permission for these interfaces. The Configuration Admin bundle must also hold `ConfigurationPermission[* ,CONFIGURE]`.

Bundles that can be configured must have the `ServicePermission[ManagedService | ManagedServiceFactory, REGISTER]`. Bundles registering `ConfigurationPlugin` objects must have `ServicePermission[ConfigurationPlugin, REGISTER]`. The Configuration Admin service must trust all services registered with the `ConfigurationPlugin` interface. Only the Configuration Admin service should have `ServicePermission[ ConfigurationPlugin, GET]`.

If a Managed Service or Managed Service Factory is implemented by an object that is also registered under another interface, it is possible, although inappropriate, for a bundle other than the Configuration Admin service implementation to call the updated method. Security-aware bundles can avoid this problem by having their updated methods check that the caller has `ConfigurationPermission[* ,CONFIGURE]`.

Bundles that want to change their own configuration need `ServicePermission[ConfigurationAdmin, GET]`. A bundle with `ConfigurationPermission[* ,CONFIGURE]` is allowed to access and modify any Configuration object.

Pre-configuration of bundles requires `ConfigurationPermission[location,CONFIGURE]` (location can use the sub-string matching rules of the Filter) because the methods that specify a location require this permission.

### 104.11.3 Configuration and Permission Administration

Configuration information has a direct influence on the permissions needed by a bundle. For example, when the Configuration Admin Bundle orders a bundle to use port 2011 for a console, that bundle also needs permission for listening to incoming connections on that port.

Both a simple and a complex solution exist for this situation.

The simple solution for this situation provides the bundle with a set of permissions that do not define specific values but allow a range of values. For example, a bundle could listen to ports above 1024 freely. All these ports could then be used for configuration.

The other solution is more complicated. In an environment where there is very strong security, the bundle would only be allowed access to a specific port. This situation requires an atomic update of both the configuration data and the permissions. If this update was not atomic, a potential security hole would exist during the period of time that the set of permissions did not match the configuration.

The following scenario can be used to update a configuration and the security permissions:

1. Stop the bundle.
2. Update the appropriate Configuration object via the Configuration Admin service.
3. Update the permissions in the Framework.
4. Start the bundle.

This scenario would achieve atomicity from the point of view of the bundle.

## 104.12 org.osgi.service.cm

Configuration Admin Package Version 1.5.

Bundles wishing to use this package must list the package in the Import-Package header of the bundle's manifest. This package has two types of users: the consumers that use the API in this package and the providers that implement the API in this package.

Example import for consumers using the API in this package:

Import-Package: org.osgi.service.cm; version="[1.5,2.0)"

Example import for providers implementing the API in this package:

Import-Package: org.osgi.service.cm; version="[1.5,1.6)"

### 104.12.1 Summary

- Configuration - The configuration information for a ManagedService or ManagedServiceFactory object.
- ConfigurationAdmin - Service for administering configuration data.
- ConfigurationEvent - A Configuration Event.
- ConfigurationException - An Exception class to inform the Configuration Admin service of problems with configuration data.
- ConfigurationListener - Listener for Configuration Events.
- ConfigurationPermission - Indicates a bundle's authority to configure bundles or be updated by Configuration Admin.
- ConfigurationPlugin - A service interface for processing configuration dictionary before the update.
- ManagedService - A service that can receive configuration data from a Configuration Admin service.
- ManagedServiceFactory - Manage multiple service instances.
- SynchronousConfigurationListener - Synchronous Listener for Configuration Events.

### 104.12.2 Permissions

#### 104.12.2.1 Configuration

- setBundleLocation(String)
  - ConfigurationPermission[this.location,CONFIGURE] - if this.location is not null
  - ConfigurationPermission[location,CONFIGURE] - if location is not null
  - ConfigurationPermission["\*",CONFIGURE] - if this.location is null or if location is null
- getBundleLocation()
  - ConfigurationPermission[this.location,CONFIGURE] - if this.location is not null
  - ConfigurationPermission["\*",CONFIGURE] - if this.location is null

#### 104.12.2.2 ConfigurationAdmin

- createFactoryConfiguration(String,String)
  - ConfigurationPermission[location,CONFIGURE] - if location is not null
  - ConfigurationPermission["\*",CONFIGURE] - if location is null
- getConfiguration(String,String)
  - ConfigurationPermission[\*,CONFIGURE] - if location is null or if the returned configuration c already exists and c.location is null
  - ConfigurationPermission[location,CONFIGURE] - if location is not null
  - ConfigurationPermission[c.location,CONFIGURE] - if the returned configuration c already exists and c.location is not null
- getConfiguration(String)
  - ConfigurationPermission[c.location,CONFIGURE] - If the configuration c already exists and c.location is not null
- listConfigurations(String)
  - ConfigurationPermission[c.location,CONFIGURE] - Only configurations c are returned for which the caller has this permission

**104.12.2.3 ManagedService**

- updated(Dictionary)
  - ConfigurationPermission[c.location,TARGET] - Required by the bundle that registered this service

**104.12.2.4 ManagedServiceFactory**

- updated(String,Dictionary)
  - ConfigurationPermission[c.location,TARGET] - Required by the bundle that registered this service

**104.12.3 public interface Configuration**

The configuration information for a ManagedService or ManagedServiceFactory object. The Configuration Admin service uses this interface to represent the configuration information for a ManagedService or for a service instance of a ManagedServiceFactory.

A Configuration object contains a configuration dictionary and allows the properties to be updated via this object. Bundles wishing to receive configuration dictionaries do not need to use this class - they register a ManagedService or ManagedServiceFactory. Only administrative bundles, and bundles wishing to update their own configurations need to use this class.

The properties handled in this configuration have case insensitive String objects as keys. However, case must be preserved from the last set key/value.

A configuration can be *bound* to a specific bundle or to a region of bundles using the *location*. In its simplest form the location is the location of the target bundle that registered a Managed Service or a Managed Service Factory. However, if the location starts with ? then the location indicates multiple delivery. In such a case the configuration must be delivered to all targets. If security is on, the Configuration Permission can be used to restrict the targets that receive updates. The Configuration Admin must only update a target when the configuration location matches the location of the target's bundle or the target bundle has a Configuration Permission with the action ConfigurationPermission.TARGET and a name that matches the configuration location. The name in the permission may contain wildcards ('\*') to match the location using the same substring matching rules as Filter. Bundles can always create, manipulate, and be updated from configurations that have a location that matches their bundle location.

If a configuration's location is null, it is not yet bound to a location. It will become bound to the location of the first bundle that registers a ManagedService or ManagedServiceFactory object with the corresponding PID.

The same Configuration object is used for configuring both a Managed Service Factory and a Managed Service. When it is important to differentiate between these two the term "factory configuration" is used.

*Concurrency* Thread-safe

*Provider Type* Consumers of this API must not implement this type

**104.12.3.1 public void delete() throws IOException**

- Delete this Configuration object. Removes this configuration object from the persistent store. Notify asynchronously the corresponding Managed Service or Managed Service Factory. A ManagedService object is notified by a call to its updated method with a null properties argument. A ManagedServiceFactory object is notified by a call to its deleted method.

Also notifies all Configuration Listeners with a ConfigurationEvent.CM\_DELETED event.

*Throws* IOException– If delete fails.

IllegalStateException– If this configuration has been deleted.

**104.12.3.2 public boolean equals(Object other)**

*other* Configuration object to compare against

- Equality is defined to have equal PIDs Two Configuration objects are equal when their PIDs are equal.

*Returns* true if equal, false if not a Configuration object or one with a different PID.

**104.12.3.3 public String getBundleLocation()**

- Get the bundle location. Returns the bundle location or region to which this configuration is bound, or null if it is not yet bound to a bundle location or region. If the location starts with ? then the configuration is delivered to all targets and not restricted to a single bundle.

*Returns* location to which this configuration is bound, or null.

*Throws* IllegalStateException– If this configuration has been deleted.

SecurityException– when the required permissions are not available

*Security* ConfigurationPermission[this.location,CONFIGURE]] – if this.location is not null

ConfigurationPermission["\*",CONFIGURE]] – if this.location is null

**104.12.3.4 public long getChangeCount()**

- Get the change count. Each Configuration must maintain a change counter that is incremented with a positive value every time the configuration is updated and its properties are stored. The counter must be incremented before the targets are updated and events are sent out.

*Returns* A monotonically increasing value reflecting changes in this Configuration.

*Throws* IllegalStateException– If this configuration has been deleted.

*Since* 1.5

**104.12.3.5 public String getFactoryPid()**

- For a factory configuration return the PID of the corresponding Managed Service Factory, else return null.

*Returns* factory PID or null

*Throws* IllegalStateException– If this configuration has been deleted.

**104.12.3.6 public String getPid()**

- Get the PID for this Configuration object.

*Returns* the PID for this Configuration object.

*Throws* IllegalStateException– if this configuration has been deleted

**104.12.3.7 public Dictionary<String, Object> getProperties()**

- Return the properties of this Configuration object. The Dictionary object returned is a private copy for the caller and may be changed without influencing the stored configuration. The keys in the returned dictionary are case insensitive and are always of type String.

If called just after the configuration is created and before update has been called, this method returns null.

*Returns* A private copy of the properties for the caller or null. These properties must not contain the "service.bundleLocation" property. The value of this property may be obtained from the getBundleLocation() method.

*Throws* IllegalStateException– If this configuration has been deleted.

**104.12.3.8 public int hashCode()**

- Hash code is based on PID. The hash code for two Configuration objects must be the same when the Configuration PID's are the same.

*Returns* hash code for this Configuration object

**104.12.3.9 public void setBundleLocation(String location)**

*location* a location, region, or null

- Bind this Configuration object to the specified location. If the location parameter is null then the Configuration object will not be bound to a location/region. It will be set to the bundle's location before the first time a Managed Service/Managed Service Factory receives this Configuration object via the updated method and before any plugins are called. The bundle location or region will be set persistently.

If the location starts with ? then all targets registered with the given PID must be updated.

If the location is changed then existing targets must be informed. If they can no longer see this configuration, the configuration must be deleted or updated with null. If this configuration becomes visible then they must be updated with this configuration.

Also notifies all Configuration Listeners with a ConfigurationEvent.CM\_LOCATION\_CHANGED event.

*Throws* IllegalStateException– If this configuration has been deleted.

SecurityException– when the required permissions are not available

SecurityException– when the required permissions are not available

*Security* ConfigurationPermission[this.location,CONFIGURE]] – if this.location is not null

ConfigurationPermission[location,CONFIGURE]] – if location is not null

ConfigurationPermission["\*",CONFIGURE]] – if this.location is null or if location is null

**104.12.3.10 public void update(Dictionary<String,?> properties) throws IOException**

*properties* the new set of properties for this configuration

- Update the properties of this Configuration object. Stores the properties in persistent storage after adding or overwriting the following properties:
  - "service.pid" : is set to be the PID of this configuration.
  - "service.factoryPid" : if this is a factory configuration it is set to the factory PID else it is not set.

These system properties are all of type String.

If the corresponding Managed Service/Managed Service Factory is registered, its updated method must be called asynchronously. Else, this callback is delayed until aforementioned registration occurs.

Also notifies all Configuration Listeners with a ConfigurationEvent.CM\_UPDATED event.

*Throws* IOException– if update cannot be made persistent

IllegalArgumentException– if the Dictionary object contains invalid configuration types or contains case variants of the same key name.

IllegalStateException– If this configuration has been deleted.

**104.12.3.11 public void update() throws IOException**

- Update the Configuration object with the current properties. Initiate the updated callback to the Managed Service or Managed Service Factory with the current properties asynchronously.



This is the only way for a bundle that uses a Configuration Plugin service to initiate a callback. For example, when that bundle detects a change that requires an update of the Managed Service or Managed Service Factory via its ConfigurationPlugin object.

*Throws* IOException– if update cannot access the properties in persistent storage

IllegalStateException– If this configuration has been deleted.

*See Also* ConfigurationPlugin

#### 104.12.4 **public interface ConfigurationAdmin**

Service for administering configuration data.

The main purpose of this interface is to store bundle configuration data persistently. This information is represented in Configuration objects. The actual configuration data is a Dictionary of properties inside a Configuration object.

There are two principally different ways to manage configurations. First there is the concept of a Managed Service, where configuration data is uniquely associated with an object registered with the service registry.

Next, there is the concept of a factory where the Configuration Admin service will maintain 0 or more Configuration objects for a Managed Service Factory that is registered with the Framework.

The first concept is intended for configuration data about "things/services" whose existence is defined externally, e.g. a specific printer. Factories are intended for "things/services" that can be created any number of times, e.g. a configuration for a DHCP server for different networks.

Bundles that require configuration should register a Managed Service or a Managed Service Factory in the service registry. A registration property named `service.pid` (persistent identifier or PID) must be used to identify this Managed Service or Managed Service Factory to the Configuration Admin service.

When the ConfigurationAdmin detects the registration of a Managed Service, it checks its persistent storage for a configuration object whose `service.pid` property matches the PID service property (`service.pid`) of the Managed Service. If found, it calls `ManagedService.updated(Dictionary)` method with the new properties. The implementation of a Configuration Admin service must run these callbacks asynchronously to allow proper synchronization.

When the Configuration Admin service detects a Managed Service Factory registration, it checks its storage for configuration objects whose `service.factoryPid` property matches the PID service property of the Managed Service Factory. For each such Configuration objects, it calls the `ManagedServiceFactory.updated` method asynchronously with the new properties. The calls to the updated method of a `ManagedServiceFactory` must be executed sequentially and not overlap in time.

In general, bundles having permission to use the Configuration Admin service can only access and modify their own configuration information. Accessing or modifying the configuration of other bundles requires `ConfigurationPermission[location,CONFIGURE]`, where `location` is the configuration location.

Configuration objects can be *bound* to a specified bundle location or to a region (configuration location starts with `?`). If a location is not set, it will be learned the first time a target is registered. If the location is learned this way, the Configuration Admin service must detect if the bundle corresponding to the location is uninstalled. If this occurs, the Configuration object must be unbound, that is its location field is set back to null.

If target's bundle location matches the configuration location it is always updated.

If the configuration location starts with `?`, that is, the location is a region, then the configuration must be delivered to all targets registered with the given PID. If security is on, the target bundle must have `ConfigurationPermission[location,TARGET]`, where `location` matches given the configu-

ration location with wildcards as in the Filter substring match. The security must be verified using the `org.osgi.framework.Bundle.hasPermission(Object)` method on the target bundle.

If a target cannot be updated because the location does not match or it has no permission and security is active then the Configuration Admin service must not do the normal callback.

The method descriptions of this class refer to a concept of "the calling bundle". This is a loose way of referring to the bundle which obtained the Configuration Admin service from the service registry. Implementations of `ConfigurationAdmin` must use a `org.osgi.framework.ServiceFactory` to support this concept.

*Concurrency* Thread-safe

*Provider Type* Consumers of this API must not implement this type

#### 104.12.4.1 **public static final String SERVICE\_BUNDLELOCATION = "service.bundleLocation"**

Configuration property naming the location of the bundle that is associated with a Configuration object. This property can be searched for but must not appear in the configuration dictionary for security reason. The property's value is of type String.

*Since* 1.1

#### 104.12.4.2 **public static final String SERVICE\_FACTORYPID = "service.factoryPid"**

Configuration property naming the Factory PID in the configuration dictionary. The property's value is of type String.

*Since* 1.1

#### 104.12.4.3 **public Configuration createFactoryConfiguration(String factoryPid) throws IOException**

*factoryPid* PID of factory (not null).

- Create a new factory Configuration object with a new PID. The properties of the new Configuration object are null until the first time that its `Configuration.update(Dictionary)` method is called.

It is not required that the `factoryPid` maps to a registered Managed Service Factory.

The Configuration object is bound to the location of the calling bundle. It is possible that the same `factoryPid` has associated configurations that are bound to different bundles. Bundles should only see the factory configurations that they are bound to or have the proper permission.

*Returns* A new Configuration object.

*Throws* `IOException`— if access to persistent storage fails.

#### 104.12.4.4 **public Configuration createFactoryConfiguration(String factoryPid, String location) throws IOException**

*factoryPid* PID of factory (not null).

*location* A bundle location string, or null.

- Create a new factory Configuration object with a new PID. The properties of the new Configuration object are null until the first time that its `Configuration.update(Dictionary)` method is called.

It is not required that the `factoryPid` maps to a registered Managed Service Factory.

The Configuration is bound to the location specified. If this location is null it will be bound to the location of the first bundle that registers a Managed Service Factory with a corresponding PID. It is possible that the same `factoryPid` has associated configurations that are bound to different bundles. Bundles should only see the factory configurations that they are bound to or have the proper permission.

If the location starts with `?` then the configuration must be delivered to all targets with the corresponding PID.

*Returns* a new Configuration object.

*Throws* IOException– if access to persistent storage fails.

SecurityException– when the require permissions are not available

*Security* ConfigurationPermission[location,CONFIGURE]] – if location is not null

ConfigurationPermission["\*",CONFIGURE]] – if location is null

#### 104.12.4.5 **public Configuration getConfiguration(String pid,String location) throws IOException**

*pid* Persistent identifier.

*location* The bundle location string, or null.

- Get an existing Configuration object from the persistent store, or create a new Configuration object.

If a Configuration with this PID already exists in Configuration Admin service return it. The location parameter is ignored in this case though it is still used for a security check.

Else, return a new Configuration object. This new object is bound to the location and the properties are set to null. If the location parameter is null, it will be set when a Managed Service with the corresponding PID is registered for the first time. If the location starts with ? then the configuration is bound to all targets that are registered with the corresponding PID.

*Returns* An existing or new Configuration object.

*Throws* IOException– if access to persistent storage fails.

SecurityException– when the require permissions are not available

*Security* ConfigurationPermission[\*,CONFIGURE]] – if location is null or if the returned configuration c already exists and c.location is null

ConfigurationPermission[location,CONFIGURE]] – if location is not null

ConfigurationPermission[c.location,CONFIGURE]] – if the returned configuration c already exists and c.location is not null

#### 104.12.4.6 **public Configuration getConfiguration(String pid) throws IOException**

*pid* persistent identifier.

- Get an existing or new Configuration object from the persistent store. If the Configuration object for this PID does not exist, create a new Configuration object for that PID, where properties are null. Bind its location to the calling bundle's location.

Otherwise, if the location of the existing Configuration object is null, set it to the calling bundle's location.

*Returns* an existing or new Configuration matching the PID.

*Throws* IOException– if access to persistent storage fails.

SecurityException– when the required permission is not available

*Security* ConfigurationPermission[c.location,CONFIGURE]] – If the configuration c already exists and c.location is not null

#### 104.12.4.7 **public Configuration[] listConfigurations(String filter) throws IOException, InvalidSyntaxException**

*filter* A filter string, or null to retrieve all Configuration objects.

- List the current Configuration objects which match the filter.

Only Configuration objects with non- null properties are considered current. That is, Configuration.getProperties() is guaranteed not to return null for each of the returned Configuration objects.

When there is no security on then all configurations can be returned. If security is on, the caller must have `ConfigurationPermission[location,CONFIGURE]`.

The syntax of the filter string is as defined in the `Filter` class. The filter can test any configuration properties including the following:

- `service.pid` - the persistent identity
- `service.factoryPid` - the factory PID, if applicable
- `service.bundleLocation` - the bundle location

The filter can also be null, meaning that all `Configuration` objects should be returned.

*Returns* All matching `Configuration` objects, or null if there aren't any.

*Throws* `IOException`—if access to persistent storage fails

`InvalidSyntaxException`—if the filter string is invalid

*Security* `ConfigurationPermission[c.location,CONFIGURE]` – Only configurations `c` are returned for which the caller has this permission

## 104.12.5 public class ConfigurationEvent

A `Configuration Event`.

`ConfigurationEvent` objects are delivered to all registered `ConfigurationListener` service objects. `ConfigurationEvents` must be delivered in chronological order with respect to each listener.

A type code is used to identify the type of event. The following event types are defined:

- `CM_UPDATED`
- `CM_DELETED`
- `CM_LOCATION_CHANGED`

Additional event types may be defined in the future.

**Security Considerations.** `ConfigurationEvent` objects do not provide `Configuration` objects, so no sensitive configuration information is available from the event. If the listener wants to locate the `Configuration` object for the specified pid, it must use `ConfigurationAdmin`.

*See Also* `ConfigurationListener`

*Since* 1.2

*Concurrency* Immutable

### 104.12.5.1 public static final int CM\_DELETED = 2

A `Configuration` has been deleted.

This `ConfigurationEvent` type that indicates that a `Configuration` object has been deleted. An event is fired when a call to `Configuration.delete()` successfully deletes a configuration.

### 104.12.5.2 public static final int CM\_LOCATION\_CHANGED = 3

The location of a `Configuration` has been changed.

This `ConfigurationEvent` type that indicates that the location of a `Configuration` object has been changed. An event is fired when a call to `Configuration.setBundleLocation(String)` successfully changes the location.

*Since* 1.4

### 104.12.5.3 public static final int CM\_UPDATED = 1

A `Configuration` has been updated.

This ConfigurationEvent type that indicates that a Configuration object has been updated with new properties. An event is fired when a call to Configuration.update(Dictionary) successfully changes a configuration.

**104.12.5.4**      **public ConfigurationEvent(ServiceReference<ConfigurationAdmin> reference,int type,String factoryPid,String pid)**

*reference* The ServiceReference object of the Configuration Admin service that created this event.

*type* The event type. See getType().

*factoryPid* The factory pid of the associated configuration if the target of the configuration is a ManagedServiceFactory. Otherwise null if the target of the configuration is a ManagedService.

*pid* The pid of the associated configuration.

- Constructs a ConfigurationEvent object from the given ServiceReference object, event type, and pids.

**104.12.5.5**      **public String getFactoryPid()**

- Returns the factory pid of the associated configuration.

*Returns* Returns the factory pid of the associated configuration if the target of the configuration is a ManagedServiceFactory. Otherwise null if the target of the configuration is a ManagedService.

**104.12.5.6**      **public String getPid()**

- Returns the pid of the associated configuration.

*Returns* Returns the pid of the associated configuration.

**104.12.5.7**      **public ServiceReference<ConfigurationAdmin> getReference()**

- Return the ServiceReference object of the Configuration Admin service that created this event.

*Returns* The ServiceReference object for the Configuration Admin service that created this event.

**104.12.5.8**      **public int getType()**

- Return the type of this event.

The type values are:

- CM\_UPDATED
- CM\_DELETED
- CM\_LOCATION\_CHANGED

*Returns* The type of this event.

**104.12.6**      **public class ConfigurationException  
extends Exception**

An Exception class to inform the Configuration Admin service of problems with configuration data.

**104.12.6.1**      **public ConfigurationException(String property,String reason)**

*property* name of the property that caused the problem, null if no specific property was the cause

*reason* reason for failure

- Create a ConfigurationException object.

**104.12.6.2**      **public ConfigurationException(String property,String reason,Throwable cause)**

*property* name of the property that caused the problem, null if no specific property was the cause

*reason* reason for failure

*cause* The cause of this exception.

- Create a ConfigurationException object.

*Since* 1.2

#### 104.12.6.3 **public Throwable getCause()**

- Returns the cause of this exception or null if no cause was set.

*Returns* The cause of this exception or null if no cause was set.

*Since* 1.2

#### 104.12.6.4 **public String getProperty()**

- Return the property name that caused the failure or null.

*Returns* name of property or null if no specific property caused the problem

#### 104.12.6.5 **public String getReason()**

- Return the reason for this exception.

*Returns* reason of the failure

#### 104.12.6.6 **public Throwable initCause(Throwable cause)**

*cause* The cause of this exception.

- Initializes the cause of this exception to the specified value.

*Returns* This exception.

*Throws* IllegalArgumentException– If the specified cause is this exception.

IllegalStateException– If the cause of this exception has already been set.

*Since* 1.2

### 104.12.7 **public interface ConfigurationListener**

Listener for Configuration Events. When a ConfigurationEvent is fired, it is asynchronously delivered to all ConfigurationListeners.

ConfigurationListener objects are registered with the Framework service registry and are notified with a ConfigurationEvent object when an event is fired.

ConfigurationListener objects can inspect the received ConfigurationEvent object to determine its type, the pid of the Configuration object with which it is associated, and the Configuration Admin service that fired the event.

Security Considerations. Bundles wishing to monitor configuration events will require ServicePermission[ConfigurationListener,REGISTER] to register a ConfigurationListener service.

*Since* 1.2

*Concurrency* Thread-safe

#### 104.12.7.1 **public void configurationEvent(ConfigurationEvent event)**

*event* The ConfigurationEvent.

- Receives notification of a Configuration that has changed.

## 104.12.8 **public final class ConfigurationPermission extends BasicPermission**

Indicates a bundle's authority to configure bundles or be updated by Configuration Admin.

*Since* 1.2

*Concurrency* Thread-safe

### 104.12.8.1 **public static final String CONFIGURE = "configure"**

Provides permission to create new configurations for other bundles as well as manipulate them. The action string "configure".

### 104.12.8.2 **public static final String TARGET = "target"**

The permission to be updated, that is, act as a Managed Service or Managed Service Factory. The action string "target".

*Since* 1.4

### 104.12.8.3 **public ConfigurationPermission(String name,String actions)**

*name* Name of the permission. Wildcards ('\*') are allowed in the name. During `implies(Permission)`, the name is matched to the requested permission using the substring matching rules used by Filters.

*actions* Comma separated list of CONFIGURE, TARGET (case insensitive).

- Create a new ConfigurationPermission.

### 104.12.8.4 **public boolean equals(Object obj)**

*obj* The object being compared for equality with this object.

- Determines the equality of two ConfigurationPermission objects.

Two ConfigurationPermission objects are equal.

*Returns* true if obj is equivalent to this ConfigurationPermission; false otherwise.

### 104.12.8.5 **public String getActions()**

- Returns the canonical string representation of the ConfigurationPermission actions.

Always returns present ConfigurationPermission actions in the following order: "configure", "target"

*Returns* Canonical string representation of the ConfigurationPermission actions.

### 104.12.8.6 **public int hashCode()**

- Returns the hash code value for this object.

*Returns* Hash code value for this object.

### 104.12.8.7 **public boolean implies(Permission p)**

*p* The target permission to check.

- Determines if a ConfigurationPermission object "implies" the specified permission.

*Returns* true if the specified permission is implied by this object; false otherwise.

### 104.12.8.8 **public PermissionCollection newPermissionCollection()**

- Returns a new PermissionCollection object suitable for storing ConfigurationPermissions.

*Returns* A new PermissionCollection object.

## 104.12.9 public interface ConfigurationPlugin

A service interface for processing configuration dictionary before the update.

A bundle registers a ConfigurationPlugin object in order to process configuration updates before they reach the Managed Service or Managed Service Factory. The Configuration Admin service will detect registrations of Configuration Plugin services and must call these services every time before it calls the ManagedService or ManagedServiceFactory updated method. The Configuration Plugin service thus has the opportunity to view and modify the properties before they are passed to the Managed Service or Managed Service Factory.

Configuration Plugin (plugin) services have full read/write access to all configuration information that passes through them.

The Integer service.cmRanking registration property may be specified. Not specifying this registration property, or setting it to something other than an Integer, is the same as setting it to the Integer zero. The service.cmRanking property determines the order in which plugins are invoked. Lower ranked plugins are called before higher ranked ones. In the event of more than one plugin having the same value of service.cmRanking, then the Configuration Admin service arbitrarily chooses the order in which they are called.

By convention, plugins with service.cmRanking < 0 or service.cmRanking > 1000 should not make modifications to the properties.

The Configuration Admin service has the right to hide properties from plugins, or to ignore some or all the changes that they make. This might be done for security reasons. Any such behavior is entirely implementation defined.

A plugin may optionally specify a cm.target registration property whose value is the PID of the Managed Service or Managed Service Factory whose configuration updates the plugin is intended to intercept. The plugin will then only be called with configuration updates that are targeted at the Managed Service or Managed Service Factory with the specified PID. Omitting the cm.target registration property means that the plugin is called for all configuration updates.

*Concurrency* Thread-safe

### 104.12.9.1 public static final String CM\_RANKING = "service.cmRanking"

A service property to specify the order in which plugins are invoked. This property contains an Integer ranking of the plugin. Not specifying this registration property, or setting it to something other than an Integer, is the same as setting it to the Integer zero. This property determines the order in which plugins are invoked. Lower ranked plugins are called before higher ranked ones.

*Since* 1.2

### 104.12.9.2 public static final String CM\_TARGET = "cm.target"

A service property to limit the Managed Service or Managed Service Factory configuration dictionaries a Configuration Plugin service receives. This property contains a String[] of PIDs. A Configuration Admin service must call a Configuration Plugin service only when this property is not set, or the target service's PID is listed in this property.

### 104.12.9.3 public void modifyConfiguration(ServiceReference<?> reference, Dictionary<String, Object> properties)

*reference* reference to the Managed Service or Managed Service Factory

*properties* The configuration properties. This argument must not contain the "service.bundleLocation" property. The value of this property may be obtained from the Configuration.getBUNDLELocation method.

- View and possibly modify the a set of configuration properties before they are sent to the Managed Service or the Managed Service Factory. The Configuration Plugin services are called in increasing



order of their `service.cmRanking` property. If this property is undefined or is a non-Integer type, 0 is used.

This method should not modify the properties unless the `service.cmRanking` of this plugin is in the range  $0 \leq \text{service.cmRanking} \leq 1000$ .

If this method throws any Exception, the Configuration Admin service must catch it and should log it.

A Configuration Plugin will only be called for properties from configurations that have a location for which the Configuration Plugin has permission when security is active. When security is not active, no filtering is done.

### 104.12.10 **public interface ManagedService**

A service that can receive configuration data from a Configuration Admin service.

A Managed Service is a service that needs configuration data. Such an object should be registered with the Framework registry with the `service.pid` property set to some unique identifier called a PID.

If the Configuration Admin service has a Configuration object corresponding to this PID, it will call back the `updated()` method of the ManagedService object, passing the properties of that Configuration object.

If it has no such Configuration object, then it calls back with a null properties argument. Registering a Managed Service will always result in a callback to the `updated()` method provided the Configuration Admin service is, or becomes active. This callback must always be done asynchronously.

Else, every time that either of the `updated()` methods is called on that Configuration object, the `ManagedService.updated()` method with the new properties is called. If the `delete()` method is called on that Configuration object, `ManagedService.updated()` is called with a null for the properties parameter. All these callbacks must be done asynchronously.

The following example shows the code of a serial port that will create a port depending on configuration information.

```
class SerialPort implements ManagedService {

    ServiceRegistration registration;
    Hashtable configuration;
    CommPortIdentifier id;

    synchronized void open(CommPortIdentifier id,
        BundleContext context) {
        this.id = id;
        registration = context.registerService(
            ManagedService.class.getName(),
            this,
            getDefaults()
        );
    }

    Hashtable getDefaults() {
        Hashtable defaults = new Hashtable();
        defaults.put( "port", id.getName() );
        defaults.put( "product", "unknown" );
        defaults.put( "baud", "9600" );
        defaults.put( Constants.SERVICE_PID,
```

```

        "com.acme.serialport." + id.getName() );
    return defaults;
}

public synchronized void updated(
    Dictionary configuration ) {
    if ( configuration == null )
        registration.setProperties( getDefaults() );
    else {
        setSpeed( configuration.get("baud") );
        registration.setProperties( configuration );
    }
}
...
}

```

As a convention, it is recommended that when a Managed Service is updated, it should copy all the properties it does not recognize into the service registration properties. This will allow the Configuration Admin service to set properties on services which can then be used by other applications.

Normally, a single Managed Service for a given PID is given the configuration dictionary, this is the configuration that is bound to the location of the registering bundle. However, when security is on, a Managed Service can have Configuration Permission to also be updated for other locations.

*Concurrency* Thread-safe

#### 104.12.10.1 **public void updated(Dictionary<String,?> properties) throws ConfigurationException**

*properties* A copy of the Configuration properties, or null. This argument must not contain the "service.bundleLocation" property. The value of this property may be obtained from the Configuration.getBundLeLocation method.

- Update the configuration for a Managed Service.

When the implementation of updated(Dictionary) detects any kind of error in the configuration properties, it should create a new ConfigurationException which describes the problem. This can allow a management system to provide useful information to a human administrator.

If this method throws any other Exception, the Configuration Admin service must catch it and should log it.

The Configuration Admin service must call this method asynchronously with the method that initiated the callback. This implies that implementors of Managed Service can be assured that the callback will not take place during registration when they execute the registration in a synchronized method.

If the location allows multiple managed services to be called back for a single configuration then the callbacks must occur in service ranking order. Changes in the location must be reflected by deleting the configuration if the configuration is no longer visible and updating when it becomes visible.

If no configuration exists for the corresponding PID, or the bundle has no access to the configuration, then the bundle must be called back with a null to signal that CM is active but there is no data.

*Throws* ConfigurationException– when the update fails

*Security* ConfigurationPermission[c.location,TARGET]] – Required by the bundle that registered this service

#### 104.12.11 **public interface ManagedServiceFactory**

Manage multiple service instances. Bundles registering this interface are giving the Configuration Admin service the ability to create and configure a number of instances of a service that the imple-

menting bundle can provide. For example, a bundle implementing a DHCP server could be instantiated multiple times for different interfaces using a factory.

Each of these *service instances* is represented, in the persistent storage of the Configuration Admin service, by a factory Configuration object that has a PID. When such a Configuration is updated, the Configuration Admin service calls the ManagedServiceFactory updated method with the new properties. When updated is called with a new PID, the Managed Service Factory should create a new factory instance based on these configuration properties. When called with a PID that it has seen before, it should update that existing service instance with the new configuration information.

In general it is expected that the implementation of this interface will maintain a data structure that maps PIDs to the factory instances that it has created. The semantics of a factory instance are defined by the Managed Service Factory. However, if the factory instance is registered as a service object with the service registry, its PID should match the PID of the corresponding Configuration object (but it should **not** be registered as a Managed Service!).

An example that demonstrates the use of a factory. It will create serial ports under command of the Configuration Admin service.

```
class SerialPortFactory
  implements ManagedServiceFactory {
  ServiceRegistration registration;
  Hashtable ports;
  void start(BundleContext context) {
    Hashtable properties = new Hashtable();
    properties.put( Constants.SERVICE_PID,
      "com.acme.serialportfactory" );
    registration = context.registerService(
      ManagedServiceFactory.class.getName(),
      this,
      properties
    );
  }
  public void updated( String pid,
    Dictionary properties ) {
    String portName = (String) properties.get("port");
    SerialPortService port =
      (SerialPort) ports.get( pid );
    if ( port == null ) {
      port = new SerialPortService();
      ports.put( pid, port );
      port.open();
    }
    if ( port.getPortName().equals(portName) )
      return;
    port.setPortName( portName );
  }
  public void deleted( String pid ) {
    SerialPortService port =
      (SerialPort) ports.get( pid );
    port.close();
    ports.remove( pid );
  }
  ...
}
```

*Concurrency* Thread-safe

#### 104.12.11.1 **public void deleted(String pid)**

*pid* the PID of the service to be removed

- Remove a factory instance. Remove the factory instance associated with the PID. If the instance was registered with the service registry, it should be unregistered. The Configuration Admin must call deleted for each instance it received in updated(String, Dictionary).

If this method throws any Exception, the Configuration Admin service must catch it and should log it.

The Configuration Admin service must call this method asynchronously.

#### 104.12.11.2 **public String getName()**

- Return a descriptive name of this factory.

*Returns* the name for the factory, which might be localized

#### 104.12.11.3 **public void updated(String pid, Dictionary<String, ?> properties) throws ConfigurationException**

*pid* The PID for this configuration.

*properties* A copy of the configuration properties. This argument must not contain the service.bundleLocation property. The value of this property may be obtained from the Configuration.getBundleLocation method.

- Create a new instance, or update the configuration of an existing instance. If the PID of the Configuration object is new for the Managed Service Factory, then create a new factory instance, using the configuration properties provided. Else, update the service instance with the provided properties.

If the factory instance is registered with the Framework, then the configuration properties should be copied to its registry properties. This is not mandatory and security sensitive properties should obviously not be copied.

If this method throws any Exception, the Configuration Admin service must catch it and should log it.

When the implementation of updated detects any kind of error in the configuration properties, it should create a new ConfigurationException which describes the problem.

The Configuration Admin service must call this method asynchronously. This implies that implementors of the ManagedServiceFactory class can be assured that the callback will not take place during registration when they execute the registration in a synchronized method.

If the security allows multiple managed service factories to be called back for a single configuration then the callbacks must occur in service ranking order.

It is valid to create multiple factory instances that are bound to different locations. Managed Service Factory services must only be updated with configurations that are bound to their location or that start with the ? prefix and for which they have permission. Changes in the location must be reflected by deleting the corresponding configuration if the configuration is no longer visible or updating when it becomes visible.

*Throws* ConfigurationException – when the configuration properties are invalid.

*Security* ConfigurationPermission[c.location, TARGET]] – Required by the bundle that registered this service

#### 104.12.12 **public interface SynchronousConfigurationListener extends ConfigurationListener**

Synchronous Listener for Configuration Events. When a ConfigurationEvent is fired, it is synchronously delivered to all SynchronousConfigurationListeners.

SynchronousConfigurationListener objects are registered with the Framework service registry and are synchronously notified with a ConfigurationEvent object when an event is fired.

SynchronousConfigurationListener objects can inspect the received ConfigurationEvent object to determine its type, the PID of the Configuration object with which it is associated, and the Configuration Admin service that fired the event.

Security Considerations. Bundles wishing to synchronously monitor configuration events will require ServicePermission[SynchronousConfigurationListener,REGISTER] to register a SynchronousConfigurationListener service.

*Since* 1.5

*Concurrency* Thread-safe

## 104.13 Changes

- Clarified that collection property values may have an ordering that must be preserved.
- Changed vector references to list.
- Clarified that a if Managed Service is registered with more than one PID and more than one PID has no configuration information available, then updated(Dictionary) can be called multiple time with a null parameter.



# 105 Metatype Service Specification

## Version 1.3

### 105.1 Introduction

The Metatype specification defines interfaces that allow bundle developers to describe attribute types in a computer readable form using so-called *metadata*.

The purpose of this specification is to allow services to specify the type information of data that they can use as arguments. The data is based on *attributes*, which are key/value pairs like properties.

A designer in a type-safe language like Java is often confronted with the choice of using the language constructs to exchange data or using a technique based on attributes/properties that are based on key/value pairs. Attributes provide an escape from the rigid type-safety requirements of modern programming languages.

Type-safety works very well for software development environments in which multiple programmers work together on large applications or systems, but often lacks the flexibility needed to receive structured data from the outside world.

The attribute paradigm has several characteristics that make this approach suitable when data needs to be communicated between different entities which "speak" different languages. Attributes are uncomplicated, resilient to change, and allow the receiver to dynamically adapt to different types of data.

As an example, the OSGi framework Specifications define several attribute types which are used in a Framework implementation, but which are also used and referenced by other OSGi specifications such as the *Configuration Admin Service Specification* on page 87. A Configuration Admin service implementation deploys attributes (key/value pairs) as configuration properties.

The Meta Type Service provides a unified access point to the Meta Type information that is associated with bundles. This Meta Type information can be defined by an XML resource in a bundle (OSGi-INF/metatype directories must be scanned for any XML resources), it can come from the Meta Type Provider service, or it can be obtained from Managed Service or Managed Service Factory services.

#### 105.1.1 Essentials

- *Conceptual model* - The specification must have a conceptual model for how classes and attributes are organized.
- *Standards* - The specification should be aligned with appropriate standards, and explained in situations where the specification is not aligned with, or cannot be mapped to, standards.
- *Remote Management* - Remote management should be taken into account.
- *Size* - Minimal overhead in size for a bundle using this specification is required.
- *Localization* - It must be possible to use this specification with different languages at the same time. This ability allows servlets to serve information in the language selected in the browser.
- *Type information* - The definition of an attribute should contain the name (if it is required), the cardinality, a label, a description, labels for enumerated values, and the Java class that should be used for the values.
- *Validation* - It should be possible to validate the values of the attributes.

### 105.1.2 Entities

- *Meta Type Service* - A service that provides a unified access point for meta type information.
- *Attribute* - A key/value pair.
- *PID* - A unique persistent ID, defined in configuration management.
- *Attribute Definition* - Defines a description, name, help text, and type information of an attribute.
- *Object Class Definition* - Defines the type of a datum. It contains a description and name of the type plus a set of AttributeDefinition objects.
- *Meta Type Provider* - Provides access to the object classes that are available for this object. Access uses the PID and a locale to find the best ObjectClassDefinition object.
- *Meta Type Information* - Provides meta type information for a bundle.

Figure 105.1 Class Diagram Meta Type Service, *org.osgi.service.metatype*

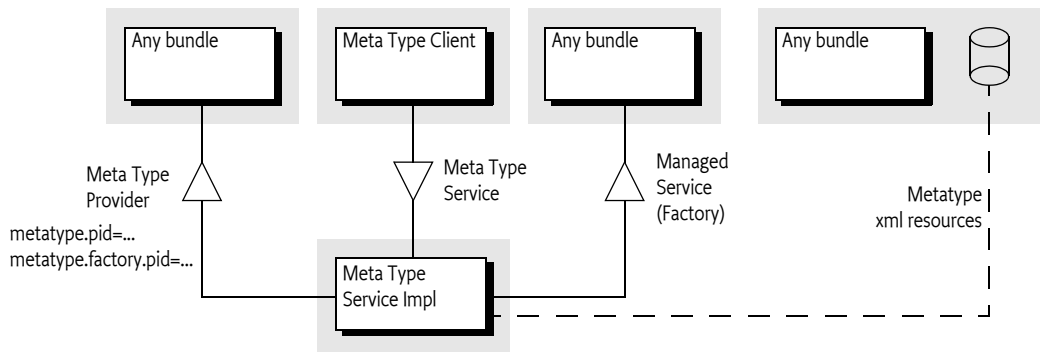

### 105.1.3 Operation

The Meta Type service defines a rich dynamic typing system for properties. The purpose of the type system is to allow reasonable User Interfaces to be constructed dynamically.

The type information is normally carried by the bundles themselves. Either by implementing the `MetaTypeProvider` interface on the Managed Service or Managed Service Factory, by carrying one or more XML resources that define a number of Meta Types in the `OSGI-INF/metatype` directories, or registering a Meta Type Provider as a service. Additionally, a Meta Type service could have other sources that are not defined in this specification.

The Meta Type Service provides unified access to Meta Types that are carried by the resident bundles. The Meta Type Service collects this information from the bundles and provides uniform access to it. A client can request the Meta Type Information associated with a particular bundle. The `MetaTypeInfo` object provides a list of `ObjectClassDefinition` objects for a bundle. These objects define all the information for a specific *object class*. An object class is a some descriptive information and a set of named attributes (which are key/value pairs).

Access to Object Class Definitions is qualified by a locale and a Persistent IDentity (PID). This specification does not specify what the PID means. One application is OSGi Configuration Management where a PID is used by the Managed Service and Managed Service Factory services. In general, a PID should be regarded as the name of a variable where an Object Class Definition defines its type.

## 105.2 Attributes Model

The Framework uses the LDAP filter syntax for searching the Framework registry. The usage of the attributes in this specification and the Framework specification closely resemble the LDAP attribute



model. Therefore, the names used in this specification have been aligned with LDAP. Consequently, the interfaces which are defined by this Specification are:

- AttributeDefinition
- ObjectClassDefinition
- MetaTypeProvider

These names correspond to the LDAP attribute model. For further information on ASN.1-defined attributes and X.500 object classes and attributes, see [2] *Understanding and Deploying LDAP Directory services*.

The LDAP attribute model assumes a global name-space for attributes, and object classes consist of a number of attributes. So, if an object class inherits the same attribute from different parents, only one copy of the attribute must become part of the object class definition. This name-space implies that a given attribute, for example cn, should *always* be the common name and the type must always be a String. An attribute cn cannot be an Integer in another object class definition. In this respect, the OSGi approach towards attribute definitions is comparable with the LDAP attribute model.

## 105.3 Object Class Definition

The ObjectClassDefinition interface is used to group the attributes which are defined in AttributeDefinition objects.

An ObjectClassDefinition object contains the information about the overall set of attributes and has the following elements:

- A name which can be returned in different locales.
- A global name-space in the registry, which is the same condition as LDAP/X.500 object classes. In these standards the OSI Object Identifier (OID) is used to uniquely identify object classes. If such an OID exists, (which can be requested at several standard organizations, and many companies already have a node in the tree) it can be returned here. Otherwise, a unique id should be returned. This id can be a Java class name (reverse domain name) or can be generated with a GUID algorithm. All LDAP-defined object classes already have an associated OID. It is strongly advised to define the object classes from existing LDAP schemes which provide many preexisting OIDs. Many such schemes exist ranging from postal addresses to DHCP parameters.
- A human-readable description of the class.
- A list of attribute definitions which can be filtered as required, or optional. Note that in X.500 the mandatory or required status of an attribute is part of the object class definition and not of the attribute definition.
- An icon, in different sizes.

## 105.4 Attribute Definition

The AttributeDefinition interface provides the means to describe the data type of attributes.

The AttributeDefinition interface defines the following elements:

- Defined names (final ints) for the data types as restricted in the Framework for the attributes, called the syntax in OSI terms, which can be obtained with the `getType()` method.
- AttributeDefinition objects should use an ID that is similar to the OID as described in the ID field for ObjectClassDefinition.
- A localized name intended to be used in user interfaces.

- A localized description that defines the semantics of the attribute and possible constraints, which should be usable for tooltips.
- An indication if this attribute should be stored as a unique value, a List, or an array of values, as well as the maximum cardinality of the type.
- The data type, as limited by the Framework service registry attribute types.
- A validation function to verify if a possible value is correct.
- A list of values and a list of localized labels. Intended for popup menus in GUIs, allowing the user to choose from a set.
- A default value (String[]). The return depends on the following cases:
  - *not specified* - Return null if this attribute is not specified.
  - *cardinality = 0* - Return an array with one element.
  - *otherwise* - Return an array with less or equal than the absolute value of cardinality, possibly empty if the value is an empty string.

## 105.5 Meta Type Service

The Meta Type Service provides unified access to Meta Type information that is associated with a Bundle. It can get this information through the following means:

- *Meta Type Resource* - A bundle can provide one or more XML resources that are contained in its JAR file. These resources contain an XML definition of meta types as well as to what PIDs these Meta Types apply. These XML resources must reside in the OSGI-INF/metatype directories of the bundle (including any fragments).
- *Managed Service [Factory] objects* - As defined in the configuration management specification, ManagedService and ManagedServiceFactory service objects can optionally implement the MetaTypeProvider interface. The Meta Type Service will only search for ManagedService and ManagedServiceFactory service objects that implement MetaTypeProvider if no meta type resources are found in the bundle.
- *Meta Type Provider service* - Bundles can register Meta Type Provider services to dynamically provide meta types for PIDs and factory PIDs.

Figure 105.2 Sources for Meta Types

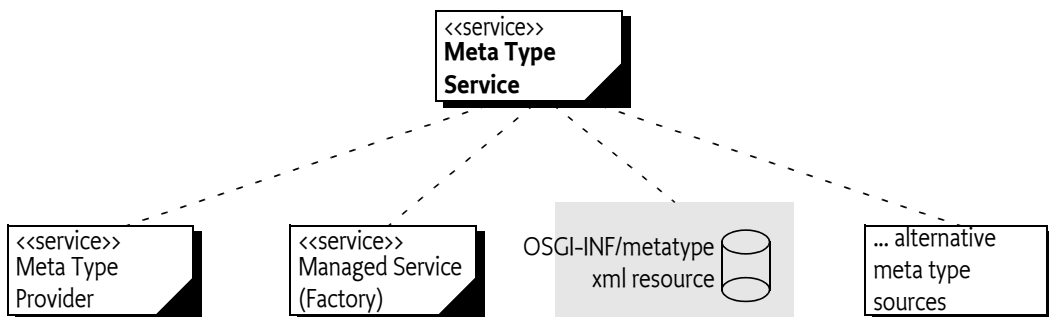

This model is depicted in Figure 105.2.

The Meta Type Service can therefore be used to retrieve meta type information for bundles which contain Meta Type resources or which provide MetaTypeProvider objects and/or services. If multiple sources define the same Object Class Definition, the Meta Type service must select which source to use. Meta Type Provider services must take precedence over Managed Service [Factory] objects implementing MetaTypeProvider or Meta Type Resources.

The MetaTypeService interface has a single method:

- [getMetaTypeInfo\(Bundle\)](#) - Given a bundle, it must return the Meta Type Information for that bundle, even if there is no meta type information available at the moment of the call.

The returned MetaTypeInfo object maintains a map of PID to ObjectClassDefinition objects. The map is keyed by locale and PID. The list of maintained PIDs is available from the MetaTypeInfo object with the following methods:

- [getPids\(\)](#) - PIDs for which Meta Types are available.
- [getFactoryPids\(\)](#) - PIDs associated with Managed Service Factory services.

These methods and their interaction with the Meta Type resource are described in *Designate Element* on page 140.

The MetaTypeInfo interface extends the MetaTypeProvider interface. The MetaType-Provider interface is used to access meta type information. It supports locale dependent information so that the text used in AttributeDefinition and ObjectClassDefinition objects can be adapted to different locales.

Which locales are supported by the MetaTypeProvider object are defined by the implementer or the meta type resources. The list of available locales can be obtained from the MetaTypeProvider object.

The MetaTypeProvider interface provides the following methods:

- [getObjectClassDefinition\(String,String\)](#) - Get access to an ObjectClassDefinition object for the given PID. The second parameter defines the locale.
- [getLocales\(\)](#) - List the locales that are available.

Locale objects are represented in String objects because not all profiles support Locale. The String holds the standard Locale presentation of:

```
locale = language ( '_' country ( '_' variation)
language ::= < defined by ISO 3166 >
country  ::= < defined by ISO 639 >
```

For example, en, nl\_BE, en\_CA\_posix are valid locales. The use of null for locale indicates that java.util.Locale.getDefault() must be used.

The Meta Type Service implementation class is the main class. It registers the org.osgi.service.metatype.MetaTypeService service and has a method to get a MetaTypeInfo object for a bundle.

Following is some sample code demonstrating how to print out all the Object Class Definitions and Attribute Definitions contained in a bundle:

```
void printMetaTypes( MetaTypeService mts, Bundle b ) {
    MetaTypeInfo mti =
        mts.getMetaTypeInfo(b);
    String [] pids = mti.getPids();
    String [] locales = mti.getLocales();

    for ( int locale = 0; locale < locales.length; locale++ ) {
        System.out.println("Locale " + locales[locale] );
        for ( int i=0; i < pids.length; i++ ) {
            ObjectClassDefinition ocd =
                mti.getObjectClassDefinition(pids[i], null);
            AttributeDefinition[] ads =
                ocd.getAttributeDefinitions(
                    ObjectClassDefinition.ALL);
            for ( int j=0; j < ads.length; j++ ) {
```

```

        System.out.println("OCD="+ocd.getName()
            + "AD="+ads[j].getName());
    }
}
}
}

```

## 105.6 Meta Type Provider Service

A Meta Type Provider service allows third party contributions to the internal Object Class Definition repository. A Meta Type Provider can contribute multiple PIDs, both factory and singleton PIDs. A Meta Type Provider service must register with both or one of the following service properties:

- `METATYPE_PID` - (String+) Provides a list of PIDs that this Meta Type Provider can provide Object Class Definitions for. The listed PIDs are intended to be used as normal singleton PIDs used by Managed Services.
- `METATYPE_FACTORY_PID` - (String+) Provides a list of factory PIDs that this Meta Type Provider can provide Object Class Definitions for. The listed PIDs are intended to be used as factory PIDs used by Managed Service Factories.

The Object Class Definitions must originate from the bundle that registered the Meta Type Provider service. Third party extenders should therefore use the bundle of their extender. A Meta Type Service must report these Object Class Definitions on the Meta Type Information of the registering bundle, merged with any other information from that bundle.

The Meta Type Service must track these Meta Type Provider services and make their Meta Types available as if they were provided on the Managed Service (Factory) services. The Meta Types must become unavailable when the Meta Type Provider service is unregistered.

## 105.7 Using the Meta Type Resources

A bundle that wants to provide meta type resources must place these resources in the OSGI-INF/metatype directory. The name of the resource must be a valid bundle entry path. All resources in that directory must be meta type documents. Fragments can contain additional meta type resources in the same directory and they must be taken into account when the meta type resources are searched. A meta type resource must be encoded in UTF-8.

The MetaType Service must support localization of the

- name
- icon
- description
- label attributes

The localization mechanism must be identical using the same mechanism as described in the Core module layer, see *Localization*, using the same property resource. However, it is possible to override the property resource in the meta type definition resources with the localization attribute of the `MetaData` element.

The Meta Type Service must examine the bundle and its fragments to locate all localization resources for the localization base name. From that list, the Meta Type Service derives the list of locales which are available for the meta type information. This list can then be returned by `MetaTypeInfo.getLocales` method. This list can change at any time because the bundle could be refreshed. Clients should be prepared that this list changes after they received it.

## 105.7.1 XML Schema of a Meta Type Resource

This section describes the schema of the meta type resource. This schema is not intended to be used during runtime for validating meta type resources. The schema is intended to be used by tools and external management systems.

The XML namespace for meta type documents must be:

`http://www.osgi.org/xmlns/metatype/v1.3.0`

The namespace abbreviation should be `metatype`. That is, the following header should be:

```
<metatype:MetaData
  xmlns:metatype="http://www.osgi.org/xmlns/metatype/v1.3.0">
```

The file can be found in the `osgi.jar` file that can be downloaded from the `www.osgi.org` web site.

Figure 105.3 XML Schema Instance Structure (Type name = Element name)

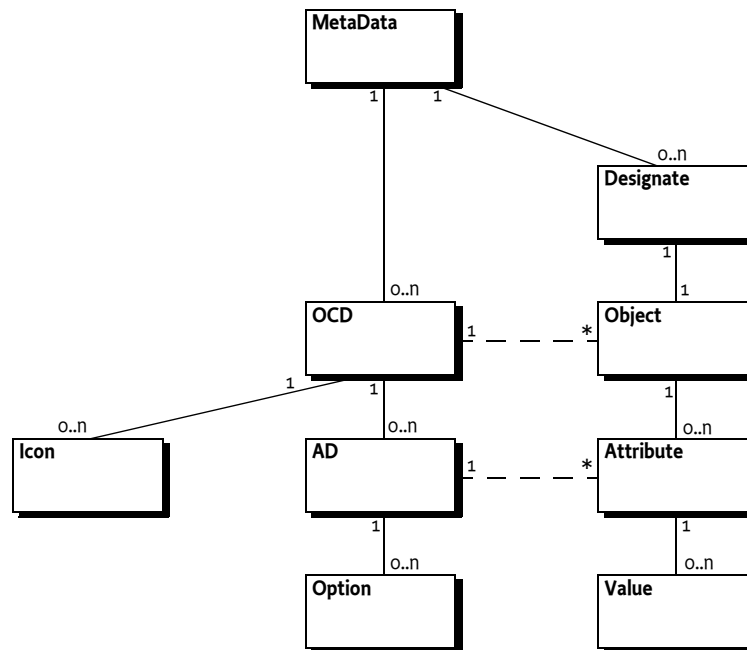

The element structure of the XML file is:

```
MetaData ::= OCD* Designate*
```

```
OCD ::= AD* Icon*
```

```
AD ::= Option*
```

```
Designate ::= Object
```

```
Object ::= Attribute*
```

```
Attribute ::= Value*
```

The different elements are described in Table 105.1.

Table 105.1 XML Schema for Meta Type resources

Attribute	Deflt	Type	Method	Description
MetaData				Top Element
localization		string		Points to the Properties file that can localize this XML. See <i>Localization</i> in <i>OSGi Core Release 6</i> .
OCD				Object Class Definition
name	<>	string	<a href="#">getName()</a>	A human readable name that can be localized.
description			<a href="#">getDescription()</a>	A human readable description of the Object Class Definition that can be localized.
id	<>		<a href="#">getID()</a>	A unique id, cannot be localized.
Designate				An association between one PID and an Object Class Definition. This element <i>designates</i> a PID to be of a certain <i>type</i> .
pid	<>	string		The PID that is associated with an OCD. This can be a reference to a factory or singleton configuration object. The PID can be a Targeted PID, if <code>factoryPid</code> is not set or empty. Either <code>pid</code> or <code>factoryPid</code> must be specified. See <i>Designate Element</i> on page 140.
factoryPid		string		If the <code>factoryPid</code> attribute is set, this Designate element defines a factory configuration for the given factory. If it is not set or empty, it designates a singleton configuration. The PID can be a Targeted PID. Either <code>pid</code> or <code>factoryPid</code> must be specified. See <i>Designate Element</i> on page 140.
bundle		string		The value is used to set the location of any configuration created using this Meta Type resource. This may contain a bundle location or a multi-location. In a Meta Type resource, using the wildcard value ('*' \u002A) indicates the bundle location of the bundle containing the resource must be used as the location. See <i>Location Binding</i> on page 93
optional	false	boolean		This is an optional attribute but can be mandatory in certain usage schemes, for example the Autoconf Resource Processor.
merge	false	boolean		If true, then this Designate element is optional, errors during processing must be ignored.
				If the PID refers to an existing configuration, then merge the properties with the existing properties if this attribute is true. Otherwise, replace the properties.

Attribute	Deflt	Type	Method	Description
AD				Attribute Definition
name		string	<a href="#">getName()</a>	A localizable name for the Attribute Definition. description
description		string	<a href="#">getDescription()</a>	A localizable description for the Attribute Definition.
id			<a href="#">getID()</a>	The unique ID of the Attribute Definition.
type		string	<a href="#">getType()</a>	The type of an attribute is an enumeration of the different scalar types. The string is mapped to one of the constants on the AttributeDefinition interface. Valid values, which are defined in the Scalar type, are:  String ↔ <a href="#">STRING</a> Long ↔ <a href="#">LONG</a> Double ↔ <a href="#">DOUBLE</a> Float ↔ <a href="#">FLOAT</a> Integer ↔ <a href="#">INTEGER</a> Byte ↔ <a href="#">BYTE</a> Char ↔ <a href="#">CHARACTER</a> Boolean ↔ <a href="#">BOOLEAN</a> Short ↔ <a href="#">SHORT</a> Password ↔ <a href="#">PASSWORD</a>
cardinality	o		<a href="#">getCardinality()</a>	The number of elements an instance can take. Positive numbers describe an array ([]) and negative numbers describe a List object.
min		string	<a href="#">validate(String)</a>	A validation value. This value is not directly available from the AttributeDefinition interface. However, the <a href="#">validate(String)</a> method must verify this. The semantics of this field depend on the type of this Attribute Definition.
max		string	<a href="#">validate(String)</a>	A validation value. Similar to the min field. When min or max are numbers, attribute values with a numeric data type are valid if min <= value <= max. Attribute values with a string (or equivalent) data type are valid if min <= value.length() <= max.

Attribute	Deflt	Type	Method	Description
default		string	<a href="#">getDefaultValue()</a>	The default value. A default is an array of String objects. The XML attribute must contain a comma delimited list. The default value is trimmed and escaped in the same way as described in the <a href="#">validate(String)</a> method. The empty string is significant and must be seen as an empty List or array if specified as the default for an attribute with a cardinality that is not equal to zero. Default values must be valid or otherwise ignored.
required	true	boolean		Required attribute. The required attribute indicates whether or not the attribute key must appear within the configuration dictionary to be valid.
Option				One option label/value for the options in an AD. Options are exclusive. The <a href="#">validate(String)</a> method must verify that an attribute value matches one of the option values when present.
label	<>	string	<a href="#">getOptionLabels()</a>	The label
value	<>	string	<a href="#">getOptionValues()</a>	The value
Icon				An icon definition.
resource	<>	string	<a href="#">getIcon(int)</a>	The resource is a URL. The base URL is assumed to be the root of the bundle containing the XML file. That is, this URL can reference another resource in the bundle using a relative URL.
size	<>	string	<a href="#">getIcon(int)</a>	The number of pixels of the icon, maps to the size parameter of the <a href="#">getIcon(int)</a> method.
Object				A definition of an instance.
ocdref	<>	string		A reference to the id attribute of an OCD element. That is, this attribute defines the OCD type of this object.
Attribute				A value for an attribute of an object.
adref	<>	string		A reference to the id of the AD in the OCD as referenced by the parent Object.
content		string		The content of the attributes. If this is an array, the content must be separated by commas (',' \u002C). Commas must be escaped as described at the default attribute of the AD element.
Value				Holds a single value. This element can be repeated multiple times under an Attribute

### 105.7.2 Designate Element

For the MetaType Service, the Designate definition is used to declare the available PIDs and factory PIDs; the Attribute elements are never used by the MetaType service.



The `getPids()` method returns an array of PIDs that were specified in the `pid` attribute of the Object elements. The `getFactoryPids()` method returns an array of the `factoryPid` attributes. For factories, the related `pid` attribute is ignored because all instances of a factory must share the same meta type.

The following example shows a metatype reference to a singleton configuration and a factory configuration.

```
<Designate pid="com.acme.designate.1">
  <Object ocdref="com.acme.designate"/>
</Designate>
<Designate factoryPid="com.acme.designate.factory"
  bundle="*">
  <Object ocdref="com.acme.designate"/>
</Designate>
```

Other schemes can embed the Object element in the Designate element to define actual instances for the Configuration Admin service. In that case the `pid` attribute must be used together with the `factoryPid` attribute. However, in that case an aliasing model is required because the Configuration Admin service does not allow the creator to choose the Configuration object's PID.

### 105.7.3 Example Metadata File

This example defines a meta type file for a Person record, based on ISO attribute types. The ids that are used are derived from ISO attributes.

```
<?xml version="1.0" encoding="UTF-8"?>
<MetaData
  xmlns="http://www.osgi.org/xmlns/metatype/v1.3.0"
  localization="person">
  <OCD name="%p" id="2.5.6.6"
    description="%p record">
    <AD name="%sex" id="2.5.4.12" type="Integer">
      <Option label="%male" value="1"/>
      <Option label="%female" value="0"/>
    </AD>
    <AD name="%sn" id="2.5.4.4" type="String"/>
    <AD name="%cn" id="2.5.4.3" type="String"/>
    <AD name="%seeAlso" id="2.5.4.34" type="String"
      cardinality="8"
      default="http://www.google.com,http://www.yahoo.com"/>
    <AD name="%telNumber" id="2.5.4.20" type="String"/>
  </OCD>

  <Designate pid="com.acme.addressbook">
    <Object ocdref="2.5.6.6"/>
  </Designate>
</MetaData>
```

Translations for this file, as indicated by the `localization` attribute must be stored in the root directory (e.g. `person_du_NL.properties`). The default localization base name for the properties is `OSGI-INF/l10n/bundle`, but can be overridden by the manifest `Bundle-Localization` header and the `localization` attribute of the Meta Data element. The property files have the base name of `person`. The Dutch, French and English translations could look like:

```
person_du_NL.properties:

person=Persoon
person\ record=Persoons beschrijving
```

```

cn=Naam
sn=Voornaam
seeAlso=Zie ook
telNumber=Tel. Nummer
sex=Geslacht
male=Mannelijk
female=Vrouwelijk

person_fr.properties:

person=Personne
person\ record=Description de la personne
cn=Nom
sn=Surnom
seeAlso=Reference
telNumber=Tel.
sex=Sexe
male=Homme
female=Femme

person_en_US.properties:

person=Person
person\ record=Person Record
cn=Name
sn=Sur Name
seeAlso=See Also
telNumber=Tel.
sex=Sex
male=Male
female=Female

```

#### 105.7.4 Object Element

The OCD element can be used to describe the possible contents of a Dictionary object. In this case, the attribute name is the key. The Object element can be used to assign a value to a Dictionary object.

For example:

```

<Designate pid="com.acme.b">
  <Object ocdref="b">
    <Attribute adref="foo" content="Zaphod Beeblebrox"/>
    <Attribute adref="bar">
      <Value>1</Value>
      <Value>2</Value>
      <Value>3</Value>
      <Value>4</Value>
      <Value>5</Value>
    </Attribute>
  </Object>
</Designate>

```

## 105.8 Meta Type Resource XML Schema

```

<schema xmlns="http://www.w3.org/2001/XMLSchema"
  xmlns:metatype="http://www.osgi.org/xmlns/metatype/v1.3.0"

```

```

targetNamespace="http://www.osgi.org/xmlns/metatype/v1.3.0"
version="1.3.0">

<element name="MetaData" type="metatype:Tmetadata" />

<complexType name="Tmetadata">
  <choice minOccurs="0" maxOccurs="unbounded">
    <element name="OCD" type="metatype:Tocd" />
    <element name="Designate" type="metatype:Tdesignate" />
    <!-- It is non-deterministic, per W3C XML Schema 1.0: http://www.w3.org/TR/xmlschema-1/#cos-nonambig
    to use namespace="##any" below. -->
    <any namespace="##other" processContents="lax" />
  </choice>
  <attribute name="localization" type="string" use="optional" />
  <anyAttribute processContents="lax" />
</complexType>

<complexType name="Tocd">
  <choice minOccurs="0" maxOccurs="unbounded">
    <element name="AD" type="metatype:Tad" />
    <element name="Icon" type="metatype:Ticon" />
    <!-- It is non-deterministic, per W3C XML Schema 1.0: http://www.w3.org/TR/xmlschema-1/#cos-nonambig
    to use namespace="##any" below. -->
    <any namespace="##other" processContents="lax" />
  </choice>
  <attribute name="name" type="string" use="required" />
  <attribute name="description" type="string" use="optional" />
  <attribute name="id" type="string" use="required" />
  <anyAttribute processContents="lax" />
</complexType>

<complexType name="Tad">
  <choice minOccurs="0" maxOccurs="unbounded">
    <element name="Option" type="metatype:Toption" />
    <!-- It is non-deterministic, per W3C XML Schema 1.0: http://www.w3.org/TR/xmlschema-1/#cos-nonambig
    to use namespace="##any" below. -->
    <any namespace="##other" processContents="lax" />
  </choice>
  <attribute name="name" type="string" use="optional" />
  <attribute name="description" type="string" use="optional" />
  <attribute name="id" type="string" use="required" />
  <attribute name="type" type="metatype:Tscalar" use="required" />
  <attribute name="cardinality" type="int" use="optional"
    default="0" />
  <attribute name="min" type="string" use="optional" />
  <attribute name="max" type="string" use="optional" />
  <attribute name="default" type="string" use="optional" />
  <attribute name="required" type="boolean" use="optional"
    default="true" />
  <anyAttribute processContents="lax" />
</complexType>

<complexType name="Tobject">
  <choice minOccurs="0" maxOccurs="unbounded">
    <element name="Attribute" type="metatype:Tattribute" />
    <!-- It is non-deterministic, per W3C XML Schema 1.0: http://www.w3.org/TR/xmlschema-1/#cos-nonambig
    to use namespace="##any" below. -->
    <any namespace="##other" processContents="lax" />
  </choice>
  <attribute name="ocdref" type="string" use="required" />
  <anyAttribute processContents="lax" />
</complexType>

<complexType name="Tattribute">
  <choice minOccurs="0" maxOccurs="unbounded">
    <element name="Value" type="string" />
    <!-- It is non-deterministic, per W3C XML Schema 1.0: http://www.w3.org/TR/xmlschema-1/#cos-nonambig
    to use namespace="##any" below. -->
    <any namespace="##other" processContents="lax" />
  </choice>
  <attribute name="adref" type="string" use="required" />
  <attribute name="content" type="string" use="optional" />
  <anyAttribute processContents="lax" />
</complexType>

```

```

<complexType name="Tdesignate">
  <sequence>
    <element name="Object" type="metatype:Tobject" minOccurs="1"
      maxOccurs="1" />
    <any namespace="##any" processContents="lax" minOccurs="0"
      maxOccurs="unbounded" />
  </sequence>
  <attribute name="pid" type="string" use="optional" />
  <attribute name="factoryPid" type="string" use="optional" />
  <attribute name="bundle" type="string" use="optional" />
  <attribute name="optional" type="boolean" default="false"
    use="optional" />
  <attribute name="merge" type="boolean" default="false"
    use="optional" />
  <anyAttribute processContents="lax" />
</complexType>

<simpleType name="Tscalar">
  <restriction base="string">
    <enumeration value="String" />
    <enumeration value="Long" />
    <enumeration value="Double" />
    <enumeration value="Float" />
    <enumeration value="Integer" />
    <enumeration value="Byte" />
    <enumeration value="Character" />
    <enumeration value="Boolean" />
    <enumeration value="Short" />
    <enumeration value="Password" />
  </restriction>
</simpleType>

<complexType name="Toption">
  <sequence>
    <any namespace="##any" processContents="lax" minOccurs="0"
      maxOccurs="unbounded" />
  </sequence>
  <attribute name="label" type="string" use="required" />
  <attribute name="value" type="string" use="required" />
  <anyAttribute processContents="lax" />
</complexType>

<complexType name="Ticon">
  <sequence>
    <any namespace="##any" processContents="lax" minOccurs="0"
      maxOccurs="unbounded" />
  </sequence>
  <attribute name="resource" type="string" use="required" />
  <attribute name="size" type="positiveInteger" use="required" />
  <anyAttribute processContents="lax" />
</complexType>

<attribute name="must-understand" type="boolean">
  <annotation>
    <documentation xml:lang="en">
      This attribute should be used by extensions to documents
      to require that the document consumer understand the
      extension.
    </documentation>
  </annotation>
</attribute>
</schema>

```

## 105.9 Meta Type Annotations

A developer can use Meta Type Annotations on a Component Property Type, see *Component Property Types* on page 330, or an interface to define an Object Class Definition in a type safe manner. The Meta Type Annotations are CLASS retention annotations intended to be used during build time to generate Meta Type Resources from the Java class files providing a convenient way to create the Meta Type Resource XML documents.

Tools processing these annotations must always generate valid Meta Type Resource XML documents. If the Meta Type Annotations are used in a way that is not supported or in error, then the tool must report the error to enable the developer to take corrective action.

### 105.9.1 ObjectClassDefinition Annotation

The [ObjectClassDefinition](#) annotation can be applied to a Component Property Type or an interface. From that type, tooling can generate an OCD element. When applied to an interface, all the methods inherited from supertypes are include as Attribute Definitions. The tool processing the annotations must be able to examine all the types in the hierarchy of the annotated type to generate the Meta Type Resource. It is an error if the tool cannot examine a type in the hierarchy.

It is an error to apply the [ObjectClassDefinition](#) annotation to concrete and abstract class types. It is also an error to apply it to an interface if any of the methods of the interface take arguments.

The [ObjectClassDefinition](#) annotation can be applied without defining any element values as default values for the [ObjectClassDefinition](#) annotation elements can be generated from the annotated type. For example:

```
@ObjectClassDefinition
@interface Config {
    boolean enabled();
    String[] names();
    String topic();
}
```

In the following larger example, the [ObjectClassDefinition](#) annotation defines the description and name of the OCD which are to be localized using the specified resource as well as an icon resource. Also, [AttributeDefinition](#) annotations are applied to the methods to supply some non-default values for the generated AD elements.

```
@ObjectClassDefinition(localization = "OSGI-INF/l10n/member",
    description = "%member.description",
    name = "%member.name"
    icon = @Icon(resource = "icon/member-32.png", size = 32))
@interface Member {
    @AttributeDefinition(type = AttributeType.PASSWORD,
        description = "%member.password.description",
        name = "%member.password.name")
    public String _password();

    @AttributeDefinition(options = {
        @Option(label = "%sstrategic", value = "strategic"),
        @Option(label = "%sprincipal", value = "principal"),
        @Option(label = "%scontributing", value = "contributing")
    },
        defaultValue = "contributing",
        description = "%member.memberbtype.description",
```

```

        name = "%member.membertype.name")
    public String type();
}

```

### 105.9.2 AttributeDefinition Annotation

The [AttributeDefinition](#) annotation is an optional annotation which can be applied to the methods in a type annotated by [ObjectClassDefinition](#). Each method of the type annotated by [ObjectClassDefinition](#) is mapped to an AD child element of the OCD element in the generated Meta Type Resource XML document. The [AttributeDefinition](#) annotation only needs to be applied to a method if values other than the defaults are desired.

The id of the Attribute Definition is generated from the method name as follows:

- A single dollar sign ('\$' \u0024) is removed unless it is followed by another dollar sign in which case the two consecutive dollar signs ("\$\$") are converted to a single dollar sign.
- A single low line ('\_' \u005F) is converted into a full stop ( '.' \u002E) unless it is followed by another low line in which case the two consecutive low lines ("\_\_") are converted to a single low line.
- All other characters are unchanged.

The generated id becomes the value of the id attribute of the AD element in the generated Meta Type Resource XML document.

### 105.9.3 Designate Annotation

The [Designate](#) annotation can be applied to a Declarative Services component class to make the connection between the pid of the component and an Object Class Definition. This annotation must be used on a type that is also annotated with the Declarative Services [Component](#) annotation. The component must only have a single PID which is used for the generated Designate element.

In the following example, the [Designate](#) annotation is applied to a Declarative Services component and references the Object Class Definition type.

```

@ObjectClassDefinition(id="my.config.ocd")
@interface Config {
    boolean enabled() default true;
    String[] names() default {"a", "b"};
    String topic() default "default/topic";
}

@Component(configurationPid="my.component.pid")
@Designate(ocd = Config.class)
public class MyComponent {
    static final String DEFAULT_TOPIC_PREFIX = "topic.prefix";
    protected void activate(Config configuration) {
        String t = configuration.topic();
    }
}

```

Tools processing these annotations will generate a Designate element in the generated Meta Type Resource XML document using the PID of the component and the id of the Object Class Definition. For example:

```

<Designate pid="my.component.pid">
    <Object ocdref="my.config.ocd"/>
</Designate>

```

## 105.10 Limitations

The OSGi MetaType specification is intended to be used for simple applications. It does not, therefore, support recursive data types, mixed types in arrays/lists, or nested arrays/lists.

## 105.11 Related Standards

One of the primary goals of this specification is to make metatype information available at run-time with minimal overhead. Many related standards are applicable to metatypes; except for Java beans, however, all other metatype standards are based on document formats (e.g. XML). In the OSGi framework, document format standards are deemed unsuitable due to the overhead required in the execution environment (they require a parser during run-time).

Another consideration is the applicability of these standards. Most of these standards were developed for management systems on platforms where resources are not necessarily a concern. In this case, a metatype standard is normally used to describe the data structures needed to control some other computer via a network. This other computer, however, does not require the metatype information as it is *implementing* this information.

In some traditional cases, a management system uses the metatype information to control objects in an OSGi framework. Therefore, the concepts and the syntax of the metatype information must be mappable to these popular standards. Clearly, then, these standards must be able to describe objects in an OSGi framework. This ability is usually not a problem, because the metatype languages used by current management systems are very powerful.

## 105.12 Capabilities

Implementations of the Metatype Service specification must provide the following capabilities.

- A capability in the `osgi.implementation` namespace declaring a specification implementation with the name `METATYPE_CAPABILITY_NAME`. This capability must also declare a uses constraint for the `org.osgi.service.metatype` package. For example:

```
Provide-Capability: osgi.implementation;  
                   osgi.implementation="osgi.metatype";  
                   version:Version="1.3";  
                   uses:="org.osgi.service.metatype"
```

This capability must follow the rules defined for the *osgi.implementation Namespace* on page 997.

- A capability in the `osgi.extender` namespace declaring an extender with the name `METATYPE_CAPABILITY_NAME`. This capability must also declare a uses constraint for the `org.osgi.service.metatype` package. For example:

```
Provide-Capability: osgi.extender;  
                   osgi.extender="osgi.metatype";  
                   version:Version="1.3";  
                   uses:="org.osgi.service.metatype"
```

This capability must follow the rules defined for the *osgi.extender Namespace* on page 993.

- A capability in the `org.osgi.service` namespace representing the [MetaTypeService](#) service. This capability must also declare a uses constraint for the `org.osgi.service.metatype` package. For example:

```
Provide-Capability: osgi.service;
  objectClass:List<String>="org.osgi.service.metatype.MetaTypeService";
  uses:="org.osgi.service.metatype"
```

This capability must follow the rules defined for the *org.osgi.service Namespace* on page 997.

## 105.13 Security Considerations

Special security issues are not applicable for this specification.

## 105.14 org.osgi.service.metatype

Metatype Package Version 1.3.

Bundles wishing to use this package must list the package in the Import-Package header of the bundle's manifest. This package has two types of users: the consumers that use the API in this package and the providers that implement the API in this package.

Example import for consumers using the API in this package:

```
Import-Package: org.osgi.service.metatype; version="[1.3,2.0]"
```

Example import for providers implementing the API in this package:

```
Import-Package: org.osgi.service.metatype; version="[1.3,1.4]"
```

### 105.14.1 Summary

- `AttributeDefinition` - An interface to describe an attribute.
- `MetaTypeInfo` - A `MetaType` Information object is created by the `MetaTypeService` to return meta type information for a specific bundle.
- `MetaTypeProvider` - Provides access to metatypes.
- `MetaTypeService` - The `MetaType` Service can be used to obtain meta type information for a bundle.
- `ObjectClassDefinition` - Description for the data type information of an objectclass.

### 105.14.2 public interface AttributeDefinition

An interface to describe an attribute.

An `AttributeDefinition` object defines a description of the data type of a property/attribute.

*Concurrency* Thread-safe

#### 105.14.2.1 public static final int BIGDECIMAL = 10

The `BIGDECIMAL` type. Attributes of this type should be stored as `BigDecimal`, `List<BigDecimal>` or `BigDecimal[]` objects depending on `getCardinality()`.

*Deprecated* As of 1.1.



**105.14.2.2 public static final int BIGINTEGER = 9**

The BIGINTEGER type. Attributes of this type should be stored as `BigInteger`, `List<BigInteger>` or `BigInteger[]` objects, depending on the `getCardinality()` value.

*Deprecated* As of 1.1.

**105.14.2.3 public static final int BOOLEAN = 11**

The BOOLEAN type. Attributes of this type should be stored as `Boolean`, `List<Boolean>` or `boolean[]` objects depending on `getCardinality()`.

**105.14.2.4 public static final int BYTE = 6**

The BYTE type. Attributes of this type should be stored as `Byte`, `List<Byte>` or `byte[]` objects, depending on the `getCardinality()` value.

**105.14.2.5 public static final int CHARACTER = 5**

The CHARACTER type. Attributes of this type should be stored as `Character`, `List<Character>` or `char[]` objects, depending on the `getCardinality()` value.

**105.14.2.6 public static final int DOUBLE = 7**

The DOUBLE type. Attributes of this type should be stored as `Double`, `List<Double>` or `double[]` objects, depending on the `getCardinality()` value.

**105.14.2.7 public static final int FLOAT = 8**

The FLOAT type. Attributes of this type should be stored as `Float`, `List<Float>` or `float[]` objects, depending on the `getCardinality()` value.

**105.14.2.8 public static final int INTEGER = 3**

The INTEGER type. Attributes of this type should be stored as `Integer`, `List<Integer>` or `int[]` objects, depending on the `getCardinality()` value.

**105.14.2.9 public static final int LONG = 2**

The LONG type. Attributes of this type should be stored as `Long`, `List<Long>` or `long[]` objects, depending on the `getCardinality()` value.

**105.14.2.10 public static final int PASSWORD = 12**

The PASSWORD type. Attributes of this type must be stored as `String`, `List<String>` or `String[]` objects depending on `getCardinality()`. A PASSWORD must be treated as a string but the type can be used to disguise the information when displayed to a user to prevent others from seeing it.

*Since* 1.2

**105.14.2.11 public static final int SHORT = 4**

The SHORT type. Attributes of this type should be stored as `Short`, `List<Short>` or `short[]` objects, depending on the `getCardinality()` value.

**105.14.2.12 public static final int STRING = 1**

The STRING type.

Attributes of this type should be stored as `String`, `List<String>` or `String[]` objects, depending on the `getCardinality()` value.

**105.14.2.13 public int getCardinality()**

- Return the cardinality of this attribute. The OSGi environment handles multi valued attributes in arrays (`[]`) or in `List` objects. The return value is defined as follows:

x = Integer.MIN_VALUE	no limit, but use List
x < 0	-x = max occurrences, store in List
x > 0	x = max occurrences, store in array []
x = Integer.MAX_VALUE	no limit, but use array []
x = 0	1 occurrence required

*Returns* The cardinality of this attribute.

#### 105.14.2.14 **public String[] getDefaultValues()**

- Return a default for this attribute. The object must be of the appropriate type as defined by the cardinality and `getType()`. The return type is a list of String objects that can be converted to the appropriate type. The cardinality of the return array must follow the absolute cardinality of this type. For example, if the cardinality = 0, the array must contain 1 element. If the cardinality is 1, it must contain 0 or 1 elements. If it is -5, it must contain from 0 to max 5 elements. Note that the special case of a 0 cardinality, meaning a single value, does not allow arrays or lists of 0 elements.

*Returns* Return a default value or null if no default exists.

#### 105.14.2.15 **public String getDescription()**

- Return a description of this attribute. The description may be localized and must describe the semantics of this type and any constraints.

*Returns* The localized description of the definition.

#### 105.14.2.16 **public String getID()**

- Unique identity for this attribute. Attributes share a global namespace in the registry. For example, an attribute `cn` or `commonName` must always be a String and the semantics are always a name of some object. They share this aspect with LDAP/X.500 attributes. In these standards the OSI Object Identifier (OID) is used to uniquely identify an attribute. If such an OID exists, (which can be requested at several standard organizations and many companies already have a node in the tree) it can be returned here. Otherwise, a unique id should be returned which can be a Java class name (reverse domain name) or generated with a GUID algorithm. Note that all LDAP defined attributes already have an OID. It is strongly advised to define the attributes from existing LDAP schemes which will give the OID. Many such schemes exist ranging from postal addresses to DHCP parameters.

*Returns* The id or oid

#### 105.14.2.17 **public String getName()**

- Get the name of the attribute. This name may be localized.

*Returns* The localized name of the definition.

#### 105.14.2.18 **public String[] getOptionLabels()**

- Return a list of labels of option values.

The purpose of this method is to allow menus with localized labels. It is associated with `getOptionValues()`. The labels returned here are ordered in the same way as the values in that method.

If the function returns null, there are no option labels available.

This list must be in the same sequence as the `getOptionValues()` method. That is, for each index *i* in `getOptionLabels()`, *i* in `getOptionValues()` should be the associated value.

For example, if an attribute can have the value `male`, `female`, `unknown`, this list can return (for dutch) new String[] { "Man", "Vrouw", "Onbekend" }.

*Returns* A list values

**105.14.2.19 public String[] getOptionValues()**

- Return a list of option values that this attribute can take.

If the function returns null, there are no option values available.

Each value must be acceptable to validate() (return "") and must be a String object that can be converted to the data type defined by getType() for this attribute.

This list must be in the same sequence as getOptionLabels(). That is, for each index *i* in getOptionValues(), *i* in getOptionLabels() should be the label.

For example, if an attribute can have the value male, female, unknown, this list can return new String[] { "male", "female", "unknown" }.

*Returns* A list values

**105.14.2.20 public int getType()**

- Return the type for this attribute.

Defined in the following constants which map to the appropriate Java type.

STRING, LONG, INTEGER, SHORT, CHARACTER, BYTE, DOUBLE, FLOAT, BOOLEAN, PASSWORD.

*Returns* The type for this attribute.

**105.14.2.21 public String validate(String value)**

*value* The value before turning it into the basic data type. If the cardinality indicates a multi-valued attribute then the given string must be escaped.

- Validate an attribute in String form. An attribute might be further constrained in value. This method will attempt to validate the attribute according to these constraints. It can return three different values:

null	No validation present
" "	No problems detected
"..."	A localized description of why the value is wrong

If the cardinality of this attribute is multi-valued then this string must be interpreted as a comma delimited string. The complete value must be trimmed from white space as well as spaces around commas. Commas (','\u002C) and spaces (' '\u0020) and backslashes ('\ '\u005C) can be escaped with another backslash. Escaped spaces must not be trimmed. For example:

```
value=" a\,b,b\,c,\ c\\,d " => [ "a,b", "b,c", " c\", "d" ]
```

*Returns* null, "", or another string

**105.14.3 public interface MetaTypeInfo extends MetaTypeProvider**

A MetaType Information object is created by the MetaTypeService to return meta type information for a specific bundle.

*Since* 1.1

*Concurrency* Thread-safe

*Provider Type* Consumers of this API must not implement this type

**105.14.3.1 public Bundle getBundle()**

- Return the bundle for which this object provides meta type information.

*Returns* Bundle for which this object provides meta type information.

**105.14.3.2 public String[] getFactoryPids()**

- Return the Factory PIDs (for ManagedServiceFactories) for which ObjectClassDefinition information is available.

*Returns* Array of Factory PIDs.

**105.14.3.3 public String[] getPids()**

- Return the PIDs (for ManagedServices) for which ObjectClassDefinition information is available.

*Returns* Array of PIDs.

**105.14.4 public interface MetaTypeProvider**

Provides access to metatypes. This interface can be implemented on a Managed Service or Managed Service Factory as well as registered as a service. When registered as a service, it must be registered with a METATYPE\_FACTORY\_PID or METATYPE\_PID service property (or both). Any PID mentioned in either of these factories must be a valid argument to the getObjectClassDefinition(String, String) method.

*Concurrency* Thread-safe

**105.14.4.1 public static final String METATYPE\_FACTORY\_PID = "metatype.factory.pid"**

Service property to signal that this service has ObjectClassDefinition objects for the given factory PIDs. The type of this service property is String+.

*Since* 1.2

**105.14.4.2 public static final String METATYPE\_PID = "metatype.pid"**

Service property to signal that this service has ObjectClassDefinition objects for the given PIDs. The type of this service property is String+.

*Since* 1.2

**105.14.4.3 public String[] getLocales()**

- Return a list of available locales. The results must be names that consists of language [ \_ country [ \_ variation ] ] as is customary in the Locale class.

*Returns* An array of locale strings or null if there is no locale specific localization can be found.

**105.14.4.4 public ObjectClassDefinition getObjectClassDefinition(String id,String locale)**

*id* The ID of the requested object class. This can be a pid or factory pid returned by getPids or getFactoryPids.

*locale* The locale of the definition or null for default locale.

- Returns an object class definition for the specified id localized to the specified locale.

The locale parameter must be a name that consists of language[ "\_" country[ "\_" variation ] ] as is customary in the Locale class. This Locale class is not used because certain profiles do not contain it.

*Returns* A ObjectClassDefinition object.

*Throws* IllegalArgumentException– If the id or locale arguments are not valid

**105.14.5 public interface MetaTypeService**

The MetaType Service can be used to obtain meta type information for a bundle. The MetaType Service will examine the specified bundle for meta type documents to create the returned MetaTypeInformation object.

If the specified bundle does not contain any meta type documents, then a `MetaTypeInfo` object will be returned that wrappers any `ManagedService` or `ManagedServiceFactory` services registered by the specified bundle that implement `MetaTypeProvider`. Thus the `MetaType Service` can be used to retrieve meta type information for bundles which contain a meta type documents or which provide their own `MetaTypeProvider` objects.

*Since* 1.1

*Concurrency* Thread-safe

*Provider Type* Consumers of this API must not implement this type

#### 105.14.5.1 **public static final String METATYPE\_CAPABILITY\_NAME = "osgi.metatype"**

Capability name for meta type document processors.

Used in Provide-Capability and Require-Capability manifest headers with the `osgi.extender` namespace. For example:

```
Require-Capability: osgi.extender;
  filter:="(&(osgi.extender=osgi.metatype)(version>=1.3)(!(version>=2.0)))"
```

*Since* 1.3

#### 105.14.5.2 **public static final String METATYPE\_DOCUMENTS\_LOCATION = "OSGI-INF/metatype"**

Location of meta type documents. The `MetaType Service` will process each entry in the meta type documents directory.

#### 105.14.5.3 **public MetaTypeInfo getMetaTypeInfo(Bundle bundle)**

*bundle* The bundle for which meta type information is requested.

- Return the `MetaType` information for the specified bundle.

*Returns* A `MetaTypeInfo` object for the specified bundle.

### 105.14.6 **public interface ObjectClassDefinition**

Description for the data type information of an objectclass.

*Concurrency* Thread-safe

#### 105.14.6.1 **public static final int ALL = -1**

Argument for `getAttributeDefinitions(int)`.

ALL indicates that all the definitions are returned. The value is -1.

#### 105.14.6.2 **public static final int OPTIONAL = 2**

Argument for `getAttributeDefinitions(int)`.

OPTIONAL indicates that only the optional definitions are returned. The value is 2.

#### 105.14.6.3 **public static final int REQUIRED = 1**

Argument for `getAttributeDefinitions(int)`.

REQUIRED indicates that only the required definitions are returned. The value is 1.

#### 105.14.6.4 **public AttributeDefinition[] getAttributeDefinitions(int filter)**

*filter* ALL,REQUIRED,OPTIONAL

- Return the attribute definitions for this object class.

Return a set of attributes. The filter parameter can distinguish between ALL,REQUIRED or the OPTIONAL attributes.

*Returns* An array of attribute definitions or null if no attributes are selected

#### 105.14.6.5 **public String getDescription()**

- Return a description of this object class. The description may be localized.

*Returns* The description of this object class.

#### 105.14.6.6 **public InputStream getIcon(int size) throws IOException**

*size* Requested size of an icon. For example, a 16x16 pixel icon has a size of 16

- Return an InputStream object that can be used to create an icon from.

Indicate the size and return an InputStream object containing an icon. The returned icon maybe larger or smaller than the indicated size.

The icon may depend on the localization.

*Returns* An InputStream representing an icon or null

*Throws* IOException– If the InputStream cannot be returned.

#### 105.14.6.7 **public String getID()**

- Return the id of this object class.

ObjectDefinition objects share a global namespace in the registry. They share this aspect with LDAP/X.500 attributes. In these standards the OSI Object Identifier (OID) is used to uniquely identify object classes. If such an OID exists, (which can be requested at several standard organizations and many companies already have a node in the tree) it can be returned here. Otherwise, a unique id should be returned which can be a java class name (reverse domain name) or generated with a GUID algorithm. Note that all LDAP defined object classes already have an OID associated. It is strongly advised to define the object classes from existing LDAP schemes which will give the OID for free. Many such schemes exist ranging from postal addresses to DHCP parameters.

*Returns* The id of this object class.

#### 105.14.6.8 **public String getName()**

- Return the name of this object class. The name may be localized.

*Returns* The name of this object class.

## 105.15 **org.osgi.service.metatype.annotations**

Metatype Annotations Package Version 1.3.

Bundles wishing to use this package must list the package in the Import-Package header of the bundle's manifest. This package has two types of users: the consumers that use the API in this package and the providers that implement the API in this package.

Example import for consumers using the API in this package:

```
Import-Package: org.osgi.service.metatype.annotations; version="[1.3,2.0]"
```

Example import for providers implementing the API in this package:

```
Import-Package: org.osgi.service.metatype.annotations; version="[1.3,1.4]"
```

### 105.15.1 **Summary**

- AttributeDefinition - AttributeDefinition information for the annotated method.
- AttributeType - Attribute types for the AttributeDefinition annotation.

- Designate - Generate a Designate element in the Meta Type Resource for an ObjectClassDefinition using the annotated Declarative Services component.
- Icon - Icon information for an ObjectClassDefinition.
- ObjectClassDefinition - Generate a Meta Type Resource using the annotated type.
- Option - Option information for an AttributeDefinition.

### 105.15.2 **@AttributeDefinition**

AttributeDefinition information for the annotated method.

Each method of a type annotated by ObjectClassDefinition has an implied AttributeDefinition annotation. This annotation is only used to specify non-default AttributeDefinition information.

The id of this AttributeDefinition is generated from the name of the annotated method. The annotated method name is processed from left to right changing each character as follows:

- A dollar sign ('\$'\u0024) is removed unless it is followed by another dollar sign in which case the two consecutive dollar signs ('\$\$') are changed to a single dollar sign.
- A low line ('\_'\u005F) is changed to a full stop ('.\u002E) unless is it followed by another low line in which case the two consecutive low lines ('\_\_') are changed to a single low line.
- All other characters are unchanged.

This id is the value of the id attribute of the generate AD element and is used as the name of the corresponding configuration property.

This annotation is not processed at runtime. It must be processed by tools and used to contribute to a Meta Type Resource document for the bundle.

*See Also* The AD element of a Meta Type Resource.

*Retention* CLASS

*Target* METHOD

#### 105.15.2.1 **String name default ""**

- The human readable name of this AttributeDefinition.

If not specified, the name of this AttributeDefinition is derived from the name of the annotated method. For example, low line ('\_'\u005F) and dollar sign ('\$'\u0024) are replaced with space (' '\u0020) and space is inserted between camel case words.

If the name begins with the percent sign ('%'\u0025), the name can be localized.

*See Also* The name attribute of the AD element of a Meta Type Resource.

#### 105.15.2.2 **String description default ""**

- The human readable description of this AttributeDefinition.

If not specified, the description of this AttributeDefinition is the empty string.

If the description begins with the percent sign ('%'\u0025), the description can be localized.

*See Also* The description attribute of the AD element of a Meta Type Resource.

#### 105.15.2.3 **AttributeType type default STRING**

- The type of this AttributeDefinition.

This must be one of the defined attributes types.

If not specified, the type is derived from the return type of the annotated method. Return types of Class and Enum are mapped to STRING. If the return type is List, Set, Collection, Iterable or some type which can be determined at annotation processing time to

1. be a subtype of Collection and
2. have a public no argument constructor,

then the type is derived from the generic type. For example, a return type of List<String> will be mapped to STRING. A return type of a single dimensional array is supported and the type is the component type of the array. Multi dimensional arrays are not supported. Annotation return types are not supported. Any unrecognized type is mapped to STRING. A tool processing the annotation should declare an error for unsupported return types.

*See Also* The type attribute of the AD element of a Meta Type Resource.

#### 105.15.2.4 **int cardinality default 0**

- The cardinality of this AttributeDefinition.

If not specified, the cardinality is derived from the return type of the annotated method. For an array return type, the cardinality is a large positive value. If the return type is List, Set, Collection, Iterable or some type which can be determined at annotation processing time to

1. be a subtype of Collection and
2. have a public no argument constructor,

the cardinality is a large negative value. Otherwise, the cardinality is 0.

*See Also* The cardinality attribute of the AD element of a Meta Type Resource.

#### 105.15.2.5 **String min default ""**

- The minimum value for this AttributeDefinition.

If not specified, there is no minimum value.

*See Also* The min attribute of the AD element of a Meta Type Resource.

#### 105.15.2.6 **String max default ""**

- The maximum value for this AttributeDefinition.

If not specified, there is no maximum value.

*See Also* The max attribute of the AD element of a Meta Type Resource.

#### 105.15.2.7 **String[] defaultValue default {}**

- The default value for this AttributeDefinition.

The specified values are concatenated into a comma delimited list to become the value of the default attribute of the generated AD element.

If not specified and the annotated method is an annotation element that has a default value, then the value of this element is the default value of the annotated element. Otherwise, there is no default value.

*See Also* The default attribute of the AD element of a Meta Type Resource.

#### 105.15.2.8 **boolean required default true**

- The required value for this AttributeDefinition.

If not specified, the value is true.

*See Also* The required attribute of the AD element of a Meta Type Resource.

#### 105.15.2.9 **Option[] options default {}**

- The option information for this AttributeDefinition.



For each specified Option, an Option element is generated for this AttributeDefinition.

If not specified, the option information is derived from the return type of the annotated method. If the return type is an enum, a single dimensional array of an enum, or a List, Set, Collection, Iterable or some type which can be determined at annotation processing time to

1. be a subtype of Collection and
2. have a public no argument constructor,

with a generic type of an enum, then the value of this element has an Option for each value of the enum. The label and value of each Option are set to the name of the corresponding enum value. Otherwise, no Option elements will be generated.

*See Also* The Option element of a Meta Type Resource.

### 105.15.3 enum AttributeType

Attribute types for the AttributeDefinition annotation.

*See Also* AttributeDefinition.type()

#### 105.15.3.1 STRING

The String type.

Attributes of this type should be stored as String, List<String> or String[] objects, depending on the cardinality value.

#### 105.15.3.2 LONG

The Long type.

Attributes of this type should be stored as Long, List<Long> or long[] objects, depending on the AttributeDefinition#cardinality() cardinality value.

#### 105.15.3.3 INTEGER

The Integer type.

Attributes of this type should be stored as Integer, List<Integer> or int[] objects, depending on the AttributeDefinition#cardinality() cardinality value.

#### 105.15.3.4 SHORT

The Short type.

Attributes of this type should be stored as Short, List<Short> or short[] objects, depending on the AttributeDefinition#cardinality() cardinality value.

#### 105.15.3.5 CHARACTER

The Character type.

Attributes of this type should be stored as Character, List<Character> or char[] objects, depending on the AttributeDefinition#cardinality() cardinality value.

#### 105.15.3.6 BYTE

The Byte type.

Attributes of this type should be stored as Byte, List<Byte> or byte[] objects, depending on the AttributeDefinition#cardinality() cardinality value.

#### 105.15.3.7 DOUBLE

The Double type.

Attributes of this type should be stored as `Double`, `List<Double>` or `double[]` objects, depending on the `AttributeDefinition#cardinality()` cardinality value.

#### 105.15.3.8 **FLOAT**

The Float type.

Attributes of this type should be stored as `Float`, `List<Float>` or `float[]` objects, depending on the `AttributeDefinition#cardinality()` cardinality value.

#### 105.15.3.9 **BOOLEAN**

The Boolean type.

Attributes of this type should be stored as `Boolean`, `List<Boolean>` or `boolean[]` objects depending on `AttributeDefinition#cardinality()` cardinality.

#### 105.15.3.10 **PASSWORD**

The Password type.

Attributes of this type must be stored as `String`, `List<String>` or `String[]` objects depending on cardinality.

A Password must be treated as a `String` but the type can be used to disguise the information when displayed to a user to prevent it from being seen.

### 105.15.4 **@Designate**

Generate a Designate element in the Meta Type Resource for an `ObjectClassDefinition` using the annotated Declarative Services component.

This annotation must be used on a type that is also annotated with the Declarative Services Component annotation. The component must only have a single PID which is used for the generated Designate element.

This annotation is not processed at runtime. It must be processed by tools and used to contribute to a Meta Type Resource document for the bundle.

*See Also* The Designate element of a Meta Type Resource.

*Retention* CLASS

*Target* TYPE

#### 105.15.4.1 **Class<?> ocd**

- The type of the `ObjectClassDefinition` for this Designate.

The specified type must be annotated with `ObjectClassDefinition`.

*See Also* The `ocdref` attribute of the Designate element of a Meta Type Resource.

#### 105.15.4.2 **boolean factory default false**

- Specifies whether this Designate is for a factory PID.

If false, then the PID value from the annotated component will be used in the `pid` attribute of the generated Designate element. If true, then the PID value from the annotated component will be used in the `factoryPid` attribute of the generated Designate element.

*See Also* The `pid` and `factoryPid` attributes of the Designate element of a Meta Type Resource.

### 105.15.5 **@Icon**

Icon information for an `ObjectClassDefinition`.

*See Also* ObjectClassDefinition.icon()

*Retention* CLASS

*Target*

#### 105.15.5.1 String resource

- The resource name for this Icon.

The resource is a URL. The resource URL can be relative to the root of the bundle containing the Meta Type Resource.

If the resource begins with the percent sign ('%' \u0025), the resource can be localized.

*See Also* The resource attribute of the Icon element of a Meta Type Resource.

#### 105.15.5.2 int size

- The pixel size of this Icon.

For example, 32 represents a 32x32 icon.

*See Also* The size attribute of the Icon element of a Meta Type Resource.

### 105.15.6 @ObjectClassDefinition

Generate a Meta Type Resource using the annotated type.

This annotation can be used without defining any element values since defaults can be generated from the annotated type. Each method of the annotated type has an implied AttributeDefinition annotation if not explicitly annotated.

This annotation may only be used on annotation types and interface types. Use on concrete or abstract class types is unsupported. If applied to an interface then all methods inherited from super types are included as attributes.

This annotation is not processed at runtime. It must be processed by tools and used to generate a Meta Type Resource document for the bundle.

*See Also* The OCD element of a Meta Type Resource.

*Retention* CLASS

*Target* TYPE

#### 105.15.6.1 String id default ""

- The id of this ObjectClassDefinition.

If not specified, the id of this ObjectClassDefinition is the fully qualified name of the annotated type using the dollar sign ('\$' \u0024) to separate nested class names from the name of their enclosing class. The id is not to be confused with a PID which can be specified by the pid() or factoryPid() element.

*See Also* The id attribute of the OCD element of a Meta Type Resource.

#### 105.15.6.2 String name default ""

- The human readable name of this ObjectClassDefinition.

If not specified, the name of this ObjectClassDefinition is derived from the id(). For example, low line ('\_' \u005F) and dollar sign ('\$' \u0024) are replaced with space (' ' \u0020) and space is inserted between camel case words.

If the name begins with the percent sign ('%' \u0025), the name can be localized.

*See Also* The name attribute of the OCD element of a Meta Type Resource.

**105.15.6.3 String description default ""**

- The human readable description of this ObjectClassDefinition.  
If not specified, the description of this ObjectClassDefinition is the empty string.  
If the description begins with the percent sign ('%' \u0025), the description can be localized.

*See Also* The description attribute of the OCD element of a Meta Type Resource.

**105.15.6.4 String localization default ""**

- The localization resource of this ObjectClassDefinition.  
This refers to a resource property entry in the bundle that can be augmented with locale information. If not specified, the localization resource for this ObjectClassDefinition is the string "OSGI-INF/110n/" followed by the id().

*See Also* The localization attribute of the MetaData element of a Meta Type Resource.

**105.15.6.5 String[] pid default {}**

- The PIDs associated with this ObjectClassDefinition.  
For each specified PID, a Designate element with a pid attribute is generated that references this ObjectClassDefinition.  
The Designate annotation can also be used to associate a Declarative Services component with an ObjectClassDefinition and generate a Designate element.

*See Also* The pid attribute of the Designate element of a Meta Type Resource., Designate

**105.15.6.6 String[] factoryPid default {}**

- The factory PIDs associated with this ObjectClassDefinition.  
For each specified factory PID, a Designate element with a factoryPid attribute is generated that references this ObjectClassDefinition.  
The Designate annotation can also be used to associate a Declarative Services component with an ObjectClassDefinition and generate a Designate element.

*See Also* The factoryPid attribute of the Designate element of a Meta Type Resource., Designate

**105.15.6.7 Icon[] icon default {}**

- The icon resources associated with this ObjectClassDefinition.  
For each specified Icon, an Icon element is generated for this ObjectClassDefinition. If not specified, no Icon elements will be generated.

*See Also* The Icon element of a Meta Type Resource.

**105.15.7 @Option**

Option information for an AttributeDefinition.

*See Also* AttributeDefinition.options()

*Retention* CLASS

*Target*

**105.15.7.1 String label default ""**

- The human readable label of this Option.  
If not specified, the label of this Option is the empty string.  
If the label begins with the percent sign ('%' \u0025), the label can be localized.

*See Also* The label attribute of the Option element of a Meta Type Resource.

#### 105.15.7.2 **String value**

- The value of this Option.

*See Also* The value attribute of the Option element of a Meta Type Resource.

## 105.16 **References**

- [1] *LDAP*.  
[http://en.wikipedia.org/wiki/Lightweight\\_Directory\\_Access\\_Protocol](http://en.wikipedia.org/wiki/Lightweight_Directory_Access_Protocol)
- [2] *Understanding and Deploying LDAP Directory services*  
Timothy Howes, et al. ISBN 1-57870-070-1, MacMillan Technical publishing.

## 105.17 **Changes**

- Changed vector references to list.
- Updates schema to 1.3.0. This includes changing Char to Character to conform with other OSGi schema and allowing some more flexibility in ordering of elements.
- Clarified that Meta Type Service will only search for ManagedService and ManagedServiceFactory service objects that implement MetaTypeProvider if no meta type resources are found in the bundle.
- Clarify that if multiple sources define the same Object Class Definition, that Meta Type Provider services must take precedence over Managed Service [Factory] objects implementing MetaTypeProvider or Meta Type Resources.
- The Meta Type Resource schema is updated to allow an OCD element to contain zero AD elements.
- New Meta Type Annotations. See *Meta Type Annotations* on page 145.
- Added capabilities that Metatype Service specification implementations must provide. See *Capabilities* on page 147.



# 106 PreferencesService Specification

## Version 1.1

### 106.1 Introduction

Many bundles need to save some data persistently - in other words, the data is required to survive the stopping and restarting of the bundle and OSGi Framework. In some cases, the data is specific to a particular user. For example, imagine a bundle that implements some kind of game. User specific persistent data could include things like the user's preferred difficulty level for playing the game. Some data is not specific to a user, which we call *system* data. An example would be a table of high scores for the game.

Bundles which need to persist data in an OSGi environment can use the file system via `org.osgi.framework.BundleContext.getDataFile`. A file system, however, can store only bytes and characters, and provides no direct support for named values and different data types.

A popular class used to address this problem for Java applications is the `java.util.Properties` class. This class allows data to be stored as key/value pairs, called *properties*. For example, a property could have a name `com.acme.fudd` and a value of `elmer`. The `Properties` class has rudimentary support for storage and retrieving with its `load` and `store` methods. The `Properties` class, however, has the following limitations:

- Does not support a naming hierarchy.
- Only supports String property values.
- Does not allow its content to be easily stored in a back-end system.
- Has no user name-space management.

Since the `Properties` class was introduced in Java 1.0, efforts have been undertaken to replace it with a more sophisticated mechanism. One of these efforts is this Preferences Service specification.

#### 106.1.1 Essentials

The focus of this specification is simplicity, not reliable access to stored data. This specification does *not* define a general database service with transactions and atomicity guarantees. Instead, it is optimized to deliver the stored information when needed, but it will return defaults, instead of throwing an exception, when the back-end store is not available. This approach may reduce the reliability of the data, but it makes the service easier to use, and allows for a variety of compact and efficient implementations.

This API is made easier to use by the fact that many bundles can be written to ignore any problems that the Preferences Service may have in accessing the back-end store, if there is one. These bundles will mostly or exclusively use the methods of the Preferences interface which are not declared to throw a `BackingStoreException`.

*This service only supports the storage of scalar values and byte arrays.* It is not intended for storing large data objects like documents or images. No standard limits are placed on the size of data objects which can be stored, but implementations are expected to be optimized for the handling of small objects.

A hierarchical naming model is supported, in contrast to the flat model of the `Properties` class. A hierarchical model maps naturally to many computing problems. For example, maintaining informa-

tion about the positions of adjustable seats in a car requires information for each seat. In a hierarchy, this information can be modeled as a node per seat.

A potential benefit of the Preferences Service is that it allows user specific preferences data to be kept in a well defined place, so that a user management system could locate it. This benefit could be useful for such operations as cleaning up files when a user is removed from the system, or to allow a user's preferences to be cloned for a new user.

The Preferences Service does *not* provide a mechanism to allow one bundle to access the preferences data of another. If a bundle wishes to allow another bundle to access its preferences data, it can pass a [Preferences](#) or [PreferencesService](#) object to that bundle.

The Preferences Service is not intended to provide configuration management functionality. For information regarding Configuration Management, refer to the *Configuration Admin Service Specification* on page 87.

### 106.1.2 Entities

The PreferencesService is a relatively simple service. It provides access to the different roots of Preferences trees. A single system root node and any number of user root nodes are supported. Each *node* of such a tree is an object that implements the Preferences interface.

This Preferences interface provides methods for traversing the tree, as well as methods for accessing the properties of the node. This interface also contains the methods to flush data into persistent storage, and to synchronize the in-memory data cache with the persistent storage.

All nodes except root nodes have a parent. Nodes can have multiple children.

Figure 106.1

Preferences Class Diagram

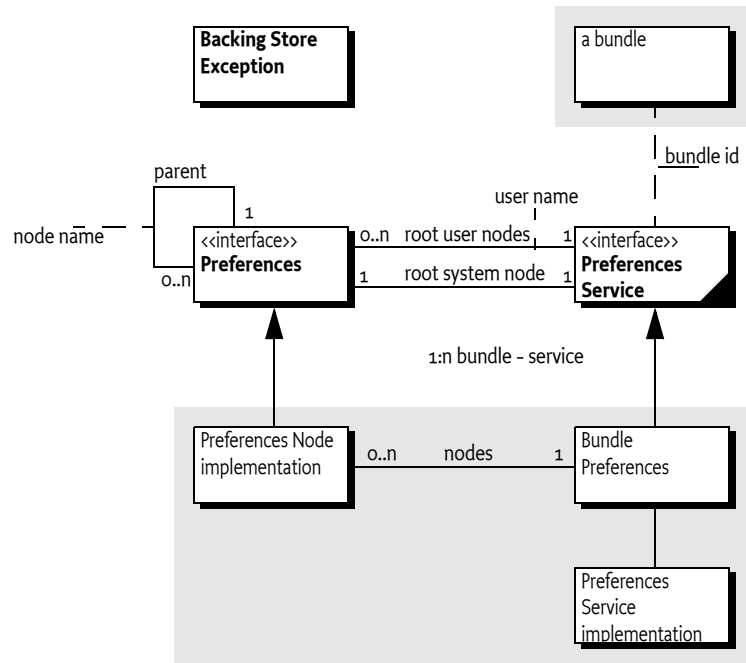

### 106.1.3 Operation

The purpose of the Preferences Service specification is to allow bundles to store and retrieve properties stored in a tree of nodes, where each node implements the Preferences interface. The PreferencesService interface allows a bundle to create or obtain a Preferences tree for system properties, as well as a Preferences tree for each user of the bundle.



This specification allows for implementations where the data is stored locally on the Framework or remotely on a back-end system.

## 106.2 Preferences Interface

Preferences is an interface that defines the methods to manipulate a node and the tree to which it belongs. A Preferences object contains:

- A set of properties in the form of key/value pairs.
- A parent node.
- A number of child nodes.

### 106.2.1 Hierarchies

A valid Preferences object always belongs to a *tree*. A tree is identified by its root node. In such a tree, a Preferences object always has a single parent, except for a root node which has a null parent.

The root node of a tree can be found by recursively calling the `parent()` method of a node until null is returned. The nodes that are traversed this way are called the *ancestors* of a node.

Each Preferences object has a private name-space for child nodes. Each child node has a name that must be unique among its siblings. Child nodes are created by getting a child node with the `node(String)` method. The String argument of this call contains a path name. Path names are explained in the next section.

Child nodes can have child nodes recursively. These objects are called the *descendants* of a node.

Descendants are automatically created when they are obtained from a Preferences object, including any intermediate nodes that are necessary for the given path. If this automatic creation is not desired, the `nodeExists(String)` method can be used to determine if a node already exists.

Figure 106.2

*Categorization of nodes in a tree*

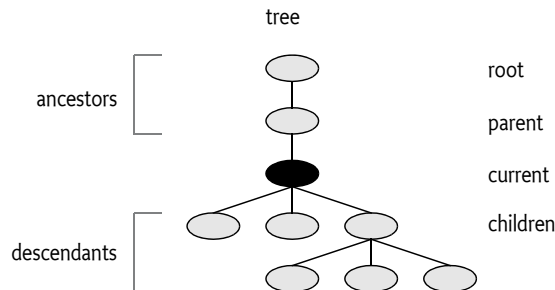

### 106.2.2 Naming

Each node has a name relative to its parent. A name may consist of Unicode characters except for the solidus (`'/' \u002F`). There are no special names, like `..` or `..`.

Empty names are reserved for root nodes. Node names that are directly created by a bundle must *always* contain at least one character.

Preferences node names and property keys are *case sensitive*: for example, `"org.osgi"` and `"oRg.oSgl"` are two distinct names.

The Preferences Service supports different roots, so there is no absolute root for the Preferences Service. This concept is similar to the Windows Registry that also supports a number of roots.

A path consists of one or more node names, separated by a solidus (`'/' \u002F`). Paths beginning with a solidus (`'/' \u002F`) are called *absolute paths* while other paths are called *relative paths*. Paths cannot

end with a solidus ('/' \u002F) except for the special case of the root node which has absolute path "/".

Path names are always associated with a specific node; this node is called the current node in the following descriptions. Paths identify nodes as follows.

- *Absolute path* - The first "/" is removed from the path, and the remainder of the path is interpreted as a relative path from the tree's root node.
- *Relative path* -
  - If the path is the empty string, it identifies the current node.
  - If the path is a name (does not contain a "/"), then it identifies the child node with that name.
  - Otherwise, the first name from the path identifies a child of the current node. The name and solidus ('/' \u002F) are then removed from the path, and the remainder of the path is interpreted as a relative path from the child node.

### 106.2.3 Tree Traversal Methods

A tree can be traversed and modified with the following methods:

- [childrenNames\(\)](#) - Returns the names of the child nodes.
- [parent\(\)](#) - Returns the parent node.
- [removeNode\(\)](#) - Removes this node and all its descendants.
- [node\(String\)](#) - Returns a Preferences object, which is created if it does not already exist. The parameter is an absolute or relative path.
- [nodeExists\(String\)](#) - Returns true if the Preferences object identified by the path parameter exists.

### 106.2.4 Properties

Each Preferences node has a set of key/value pairs called properties. These properties consist of:

- *Key* - A key is a String object and *case sensitive*.
- The name-space of these keys is separate from that of the child nodes. A Preferences node could have both a child node named fudd and a property named fudd.
- *Value* - A value can always be stored and retrieved as a String object. Therefore, it must be possible to encode/decode all values into/from String objects (though it is not required to store them as such, an implementation is free to store and retrieve the value in any possible way as long as the String semantics are maintained). A number of methods are available to store and retrieve values as primitive types. These methods are provided both for the convenience of the user of the Preferences interface, and to allow an implementation the option of storing the values in a more compact form.

All the keys that are defined in a Preferences object can be obtained with the [keys\(\)](#) method. The [clear\(\)](#) method can be used to clear all properties from a Preferences object. A single property can be removed with the [remove\(String\)](#) method.

### 106.2.5 Storing and Retrieving Properties

The Preferences interface has a number of methods for storing and retrieving property values based on their key. All the put\* methods take as parameters a key and a value. All the get\* methods take as parameters a key and a default value.

- [put\(String,String\)](#), [get\(String,String\)](#)
- [putBoolean\(String,boolean\)](#), [getBoolean\(String,boolean\)](#)
- [putInt\(String,int\)](#), [getInt\(String,int\)](#)
- [putLong\(String,long\)](#), [getLong\(String,long\)](#)
- [putFloat\(String,float\)](#), [getFloat\(String,float\)](#)

- `putDouble(String,double),getDouble(String,double)`
- `putByteArray(String,byte[]),getByteArray(String,byte[])`

The methods act as if all the values are stored as `String` objects, even though implementations may use different representations for the different types. For example, a property can be written as a `String` object and read back as a `float`, providing that the string can be parsed as a valid Java `float` object. In the event of a parsing error, the `get*` methods do not raise exceptions, but instead return their default parameters.

### 106.2.6 Defaults

All `get*` methods take a default value as a parameter. The reasons for having such a default are:

- When a property for a Preferences object has not been set, the default is returned instead. In most cases, the bundle developer does not have to distinguish whether or not a property exists.
- A *best effort* strategy has been a specific design choice for this specification. The bundle developer should not have to react when the back-end store is not available. In those cases, the default value is returned without further notice.

Bundle developers who want to assure that the back-end store is available should call the `flush` or `sync` method. Either of these methods will throw a `BackingStoreException` if the back-end store is not available.

## 106.3 Concurrency

This specification specifically allows an implementation to modify Preferences objects in a back-end store. If the back-end store is shared by multiple processes, concurrent updates may cause differences between the back-end store and the in-memory Preferences objects.

Bundle developers can partly control this concurrency with the `flush()` and `sync()` method. Both methods operate on a Preferences object.

The `flush` method performs the following actions:

- Stores (makes persistent) any ancestors (including the current node) that do not exist in the persistent store.
- Stores any properties which have been modified in this node since the last time it was flushed.
- Removes from the persistent store any child nodes that were removed from this object since the last time it was flushed.
- Flushes all existing child nodes.

The `sync` method will first flush, and then ensure that any changes that have been made to the current node and its descendants in the back-end store (by some other process) take effect. For example, it could fetch all the descendants into a local cache, or it could clear all the descendants from the cache so that they will be read from the back-end store as required.

If either method fails, a `BackingStoreException` is thrown.

The `flush` or `sync` methods provide no atomicity guarantee. When updates to the same back-end store are done concurrently by two different processes, the result may be that changes made by different processes are intermingled. To avoid this problem, implementations may simply provide a dedicated section (or name-space) in the back-end store for each OSGi environment, so that clashes do not arise, in which case there is no reason for bundle programmers to ever call `sync`.

In cases where `sync` is used, the bundle programmer needs to take into account that changes from different processes may become intermingled, and the level of granularity that can be assumed is the individual property level. Hence, for example, if two properties need to be kept in lockstep, so

that one should not be changed without a corresponding change to the other, consider combining them into a single property, which would then need to be parsed into its two constituent parts.

## 106.4 PreferencesService Interface

The PreferencesService is obtained from the Framework's service registry in the normal way. Its purpose is to provide access to Preferences root nodes.

A Preferences Service maintains a system root and a number of user roots. User roots are automatically created, if necessary, when they are requested. Roots are maintained on a per bundle basis. For example, a user root called *elmer* in one bundle is distinct from a user root with the same name in another bundle. Also, each bundle has its own system root. Implementations should use a Service-Factory service object to create a separate PreferencesService object for each bundle.

The precise description of *user* and *system* will vary from one bundle to another. The Preference Service only provides a mechanism, the bundle may use this mechanism in any desired way.

The PreferencesService interface has the following methods to access the system root and user roots:

- `getSystemPreferences()` - Return a Preferences object that is the root of the system preferences tree.
- `getUserPreferences(String)` - Return a Preferences object associated with the user name that is given as argument. If the user does not exist, a new root is created atomically.
- `getUsers()` - Return an array of the names of all the users for whom a Preferences tree exists.

## 106.5 Cleanup

The Preferences Service must listen for bundle uninstall events, and remove all the preferences data for the bundle that is being uninstalled. The Preferences Service must use the bundle id for the association and not the location.

It also must handle the possibility of a bundle getting uninstalled while the Preferences Service is stopped. Therefore, it must check on startup whether preferences data exists for any bundle which is not currently installed. If it does, that data must be removed.

## 106.6 org.osgi.service.prefs

Preferences Service Package Version 1.1.

Bundles wishing to use this package must list the package in the Import-Package header of the bundle's manifest. This package has two types of users: the consumers that use the API in this package and the providers that implement the API in this package.

Example import for consumers using the API in this package:

```
Import-Package: org.osgi.service.prefs; version="[1.1,2.0]"
```

Example import for providers implementing the API in this package:

```
Import-Package: org.osgi.service.prefs; version="[1.1,1.2]"
```

## 106.6.1 Summary

- `BackingStoreException` - Thrown to indicate that a preferences operation could not complete because of a failure in the backing store, or a failure to contact the backing store.
- `Preferences` - A node in a hierarchical collection of preference data.
- `PreferencesService` - The Preferences Service.

## 106.6.2 **public class BackingStoreException** **extends Exception**

Thrown to indicate that a preferences operation could not complete because of a failure in the backing store, or a failure to contact the backing store.

### 106.6.2.1 **public BackingStoreException(String message)**

*message* The detail message.

- Constructs a `BackingStoreException` with the specified detail message.

### 106.6.2.2 **public BackingStoreException(String message,Throwable cause)**

*message* The detail message.

*cause* The cause of the exception. May be null.

- Constructs a `BackingStoreException` with the specified detail message.

*Since* 1.1

### 106.6.2.3 **public Throwable getCause()**

- Returns the cause of this exception or null if no cause was set.

*Returns* The cause of this exception or null if no cause was set.

*Since* 1.1

### 106.6.2.4 **public Throwable initCause(Throwable cause)**

*cause* The cause of this exception.

- Initializes the cause of this exception to the specified value.

*Returns* This exception.

*Throws* `IllegalArgumentException`– If the specified cause is this exception.

`IllegalStateException`– If the cause of this exception has already been set.

*Since* 1.1

## 106.6.3 **public interface Preferences**

A node in a hierarchical collection of preference data.

This interface allows applications to store and retrieve user and system preference data. This data is stored persistently in an implementation-dependent backing store. Typical implementations include flat files, OS-specific registries, directory servers and SQL databases.

For each bundle, there is a separate tree of nodes for each user, and one for system preferences. The precise description of "user" and "system" will vary from one bundle to another. Typical information stored in the user preference tree might include font choice, and color choice for a bundle which interacts with the user via a servlet. Typical information stored in the system preference tree might include installation data, or things like high score information for a game program.

Nodes in a preference tree are named in a similar fashion to directories in a hierarchical file system. Every node in a preference tree has a *node name* (which is not necessarily unique), a unique *absolute path name*, and a path name *relative* to each ancestor including itself.

The root node has a node name of the empty String object (""). Every other node has an arbitrary node name, specified at the time it is created. The only restrictions on this name are that it cannot be the empty string, and it cannot contain the slash character ('/').

The root node has an absolute path name of "/". Children of the root node have absolute path names of "/" + <node name>. All other nodes have absolute path names of <parent's absolute path name> + "/" + <node name>. Note that all absolute path names begin with the slash character.

A node *n*'s path name relative to its ancestor *a* is simply the string that must be appended to *a*'s absolute path name in order to form *n*'s absolute path name, with the initial slash character (if present) removed. Note that:

- No relative path names begin with the slash character.
- Every node's path name relative to itself is the empty string.
- Every node's path name relative to its parent is its node name (except for the root node, which does not have a parent).
- Every node's path name relative to the root is its absolute path name with the initial slash character removed.

Note finally that:

- No path name contains multiple consecutive slash characters.
- No path name with the exception of the root's absolute path name end in the slash character.
- Any string that conforms to these two rules is a valid path name.

Each Preference node has zero or more properties associated with it, where a property consists of a name and a value. The bundle writer is free to choose any appropriate names for properties. Their values can be of type String, long, int, boolean, byte[], float, or double but they can always be accessed as if they were String objects.

All node name and property name comparisons are case-sensitive.

All of the methods that modify preference data are permitted to operate asynchronously; they may return immediately, and changes will eventually propagate to the persistent backing store, with an implementation-dependent delay. The flush method may be used to synchronously force updates to the backing store.

Implementations must automatically attempt to flush to the backing store any pending updates for a bundle's preferences when the bundle is stopped or otherwise ungets the Preferences Service.

The methods in this class may be invoked concurrently by multiple threads in a single Java Virtual Machine (JVM) without the need for external synchronization, and the results will be equivalent to some serial execution. If this class is used concurrently *by multiple JVMs* that store their preference data in the same backing store, the data store will not be corrupted, but no other guarantees are made concerning the consistency of the preference data.

*No Implement* Consumers of this API must not implement this interface

### 106.6.3.1 public String absolutePath()

- Returns this node's absolute path name. Note that:
  - Root node - The path name of the root node is "/".
  - Slash at end - Path names other than that of the root node may not end in slash ('/').
  - Unusual names - "." and ".." have *no* special significance in path names.

- Illegal names - The only illegal path names are those that contain multiple consecutive slashes, or that end in slash and are not the root.

*Returns* this node's absolute path name.

#### 106.6.3.2 **public String[] childrenNames() throws BackingStoreException**

- Returns the names of the children of this node. (The returned array will be of size zero if this node has no children and not null!)

*Returns* the names of the children of this node.

*Throws* BackingStoreException– if this operation cannot be completed due to a failure in the backing store, or inability to communicate with it.

IllegalStateException– if this node (or an ancestor) has been removed with the removeNode() method.

#### 106.6.3.3 **public void clear() throws BackingStoreException**

- Removes all of the properties (key-value associations) in this node. This call has no effect on any descendants of this node.

*Throws* BackingStoreException– if this operation cannot be completed due to a failure in the backing store, or inability to communicate with it.

IllegalStateException– if this node (or an ancestor) has been removed with the removeNode() method.

*See Also* remove(String)

#### 106.6.3.4 **public void flush() throws BackingStoreException**

- Forces any changes in the contents of this node and its descendants to the persistent store.

Once this method returns successfully, it is safe to assume that all changes made in the subtree rooted at this node prior to the method invocation have become permanent.

Implementations are free to flush changes into the persistent store at any time. They do not need to wait for this method to be called.

When a flush occurs on a newly created node, it is made persistent, as are any ancestors (and descendants) that have yet to be made persistent. Note however that any properties value changes in ancestors are *not* guaranteed to be made persistent.

*Throws* BackingStoreException– if this operation cannot be completed due to a failure in the backing store, or inability to communicate with it.

IllegalStateException– if this node (or an ancestor) has been removed with the removeNode() method.

*See Also* sync()

#### 106.6.3.5 **public String get(String key,String def)**

*key* key whose associated value is to be returned.

*def* the value to be returned in the event that this node has no value associated with key or the backing store is inaccessible.

- Returns the value associated with the specified key in this node. Returns the specified default if there is no value associated with the key, or the backing store is inaccessible.

*Returns* the value associated with key, or def if no value is associated with key.

*Throws* IllegalStateException– if this node (or an ancestor) has been removed with the removeNode() method.

NullPointerException– if key is null. (A null default is permitted.)

#### 106.6.3.6 **public boolean getBoolean(String key,boolean def)**

*key* key whose associated value is to be returned as a boolean.

*def* the value to be returned in the event that this node has no value associated with key or the associated value cannot be interpreted as a boolean or the backing store is inaccessible.

- Returns the boolean value represented by the String object associated with the specified key in this node. Valid strings are "true", which represents true, and "false", which represents false. Case is ignored, so, for example, "TRUE" and "False" are also valid. This method is intended for use in conjunction with the putBoolean(String, boolean) method.

Returns the specified default if there is no value associated with the key, the backing store is inaccessible, or if the associated value is something other than "true" or "false", ignoring case.

*Returns* the boolean value represented by the String object associated with key in this node, or null if the associated value does not exist or cannot be interpreted as a boolean.

*Throws* NullPointerException– if key is null.

IllegalStateException– if this node (or an ancestor) has been removed with the removeNode() method.

*See Also* get(String,String), putBoolean(String,boolean)

#### 106.6.3.7 **public byte[] getByteArray(String key,byte[] def)**

*key* key whose associated value is to be returned as a byte[] object.

*def* the value to be returned in the event that this node has no value associated with key or the associated value cannot be interpreted as a byte[] type, or the backing store is inaccessible.

- Returns the byte[] value represented by the String object associated with the specified key in this node. Valid String objects are *Base64* encoded binary data, as defined in RFC 2045 [<http://www.ietf.org/rfc/rfc2045.txt>], Section 6.8, with one minor change: the string must consist solely of characters from the *Base64 Alphabet*; no newline characters or extraneous characters are permitted. This method is intended for use in conjunction with the putByteArray(String, byte[]) method.

Returns the specified default if there is no value associated with the key, the backing store is inaccessible, or if the associated value is not a valid Base64 encoded byte array (as defined above).

*Returns* the byte[] value represented by the String object associated with key in this node, or def if the associated value does not exist or cannot be interpreted as a byte[].

*Throws* NullPointerException– if key is null. (A null value for def is permitted.)

IllegalStateException– if this node (or an ancestor) has been removed with the removeNode() method.

*See Also* get(String,String), putByteArray(String,byte[])

#### 106.6.3.8 **public double getDouble(String key,double def)**

*key* key whose associated value is to be returned as a double value.

*def* the value to be returned in the event that this node has no value associated with key or the associated value cannot be interpreted as a double type or the backing store is inaccessible.

- Returns the double value represented by the String object associated with the specified key in this node. The String object is converted to a double value as by Double.parseDouble(String). Returns the specified default if there is no value associated with the key, the backing store is inaccessible, or if Double.parseDouble(String) would throw a NumberFormatException if the associated value were passed. This method is intended for use in conjunction with the putDouble method.



*Returns* the double value represented by the String object associated with key in this node, or def if the associated value does not exist or cannot be interpreted as a double type.

*Throws* IllegalStateException– if this node (or an ancestor) has been removed with the removeNode() method.

NullPointerException– if key is null.

*See Also* putDouble(String,double), get(String,String)

#### 106.6.3.9 **public float getFloat(String key,float def)**

*key* key whose associated value is to be returned as a float value.

*def* the value to be returned in the event that this node has no value associated with key or the associated value cannot be interpreted as a float type or the backing store is inaccessible.

- Returns the float value represented by the String object associated with the specified key in this node. The String object is converted to a float value as by Float.parseFloat(String). Returns the specified default if there is no value associated with the key, the backing store is inaccessible, or if Float.parseFloat(String) would throw a NumberFormatException if the associated value were passed. This method is intended for use in conjunction with the putFloat(String, float) method.

*Returns* the float value represented by the string associated with key in this node, or def if the associated value does not exist or cannot be interpreted as a float type.

*Throws* IllegalStateException– if this node (or an ancestor) has been removed with the removeNode() method.

NullPointerException– if key is null.

*See Also* putFloat(String,float), get(String,String)

#### 106.6.3.10 **public int getInt(String key,int def)**

*key* key whose associated value is to be returned as an int .

*def* the value to be returned in the event that this node has no value associated with key or the associated value cannot be interpreted as an int or the backing store is inaccessible.

- Returns the int value represented by the String object associated with the specified key in this node. The String object is converted to an int as by Integer.parseInt(String). Returns the specified default if there is no value associated with the key, the backing store is inaccessible, or if Integer.parseInt(String) would throw a NumberFormatException if the associated value were passed. This method is intended for use in conjunction with the putInt(String, int) method.

*Returns* the int value represented by the String object associated with key in this node, or def if the associated value does not exist or cannot be interpreted as an int type.

*Throws* NullPointerException– if key is null.

IllegalStateException– if this node (or an ancestor) has been removed with the removeNode() method.

*See Also* putInt(String,int), get(String,String)

#### 106.6.3.11 **public long getLong(String key,long def)**

*key* key whose associated value is to be returned as a long value.

*def* the value to be returned in the event that this node has no value associated with key or the associated value cannot be interpreted as a long type or the backing store is inaccessible.

- Returns the long value represented by the String object associated with the specified key in this node. The String object is converted to a long as by Long.parseLong(String). Returns the specified default if there is no value associated with the key, the backing store is inaccessible, or if

`Long.parseLong(String)` would throw a `NumberFormatException` if the associated value were passed. This method is intended for use in conjunction with the `putLong(String, long)` method.

*Returns* the long value represented by the `String` object associated with key in this node, or `def` if the associated value does not exist or cannot be interpreted as a long type.

*Throws* `NullPointerException`— if key is null.

`IllegalStateException`— if this node (or an ancestor) has been removed with the `removeNode()` method.

*See Also* `putLong(String, long)`, `get(String, String)`

#### 106.6.3.12 **public String[] keys() throws BackingStoreException**

- Returns all of the keys that have an associated value in this node. (The returned array will be of size zero if this node has no preferences and not null!)

*Returns* an array of the keys that have an associated value in this node.

*Throws* `BackingStoreException`— if this operation cannot be completed due to a failure in the backing store, or inability to communicate with it.

`IllegalStateException`— if this node (or an ancestor) has been removed with the `removeNode()` method.

#### 106.6.3.13 **public String name()**

- Returns this node's name, relative to its parent.

*Returns* this node's name, relative to its parent.

#### 106.6.3.14 **public Preferences node(String pathName)**

*pathName* the path name of the Preferences object to return.

- Returns a named Preferences object (node), creating it and any of its ancestors if they do not already exist. Accepts a relative or absolute pathname. Absolute pathnames (which begin with '/') are interpreted relative to the root of this node. Relative pathnames (which begin with any character other than '/') are interpreted relative to this node itself. The empty string ("") is a valid relative pathname, referring to this node itself.

If the returned node did not exist prior to this call, this node and any ancestors that were created by this call are not guaranteed to become persistent until the `flush` method is called on the returned node (or one of its descendants).

*Returns* the specified Preferences object.

*Throws* `IllegalArgumentException`— if the path name is invalid.

`IllegalStateException`— if this node (or an ancestor) has been removed with the `removeNode()` method.

`NullPointerException`— if path name is null.

*See Also* `flush()`

#### 106.6.3.15 **public boolean nodeExists(String pathName) throws BackingStoreException**

*pathName* the path name of the node whose existence is to be checked.

- Returns true if the named node exists. Accepts a relative or absolute pathname. Absolute pathnames (which begin with '/') are interpreted relative to the root of this node. Relative pathnames (which begin with any character other than '/') are interpreted relative to this node itself. The pathname "" is valid, and refers to this node itself.

If this node (or an ancestor) has already been removed with the `removeNode()` method, it is legal to invoke this method, but only with the pathname `""`; the invocation will return `false`. Thus, the idiom `p.nodeExists("")` may be used to test whether `p` has been removed.

*Returns* true if the specified node exists.

*Throws* `BackingStoreException`—if this operation cannot be completed due to a failure in the backing store, or inability to communicate with it.

`IllegalStateException`—if this node (or an ancestor) has been removed with the `removeNode()` method and `pathname` is not the empty string `""`.

`IllegalArgumentException`—if the path name is invalid (i.e., it contains multiple consecutive slash characters, or ends with a slash character and is more than one character long).

#### 106.6.3.16 **public Preferences parent()**

- Returns the parent of this node, or null if this is the root.

*Returns* the parent of this node.

*Throws* `IllegalStateException`—if this node (or an ancestor) has been removed with the `removeNode()` method.

#### 106.6.3.17 **public void put(String key,String value)**

*key* key with which the specified value is to be associated.

*value* value to be associated with the specified key.

- Associates the specified value with the specified key in this node.

*Throws* `NullPointerException`—if `key` or `value` is null.

`IllegalStateException`—if this node (or an ancestor) has been removed with the `removeNode()` method.

#### 106.6.3.18 **public void putBoolean(String key,boolean value)**

*key* key with which the string form of `value` is to be associated.

*value* value whose string form is to be associated with `key`.

- Associates a `String` object representing the specified boolean value with the specified key in this node. The associated string is "true" if the value is true, and "false" if it is false. This method is intended for use in conjunction with the `getBoolean(String, boolean)` method.

Implementor's note: it is *not* necessary that the value be represented by a string in the backing store. If the backing store supports boolean values, it is not unreasonable to use them. This implementation detail is not visible through the Preferences API, which allows the value to be read as a boolean (with `getBoolean()`) or a `String` (with `get()`) type.

*Throws* `NullPointerException`—if `key` is null.

`IllegalStateException`—if this node (or an ancestor) has been removed with the `removeNode()` method.

*See Also* `getBoolean(String,boolean)`, `get(String,String)`

#### 106.6.3.19 **public void putByteArray(String key,byte[] value)**

*key* key with which the string form of `value` is to be associated.

*value* value whose string form is to be associated with `key`.

- Associates a `String` object representing the specified `byte[]` with the specified key in this node. The associated `String` object is the *Base64* encoding of the `byte[]`, as defined in RFC 2045 [<http://www.ietf.org/rfc/rfc2045.txt>], Section 6.8, with one minor change: the string will consist solely of

characters from the *Base64 Alphabet*; it will not contain any newline characters. This method is intended for use in conjunction with the `getBytes(String, byte[])` method.

Implementor's note: it is *not* necessary that the value be represented by a `String` type in the backing store. If the backing store supports `byte[]` values, it is not unreasonable to use them. This implementation detail is not visible through the Preferences API, which allows the value to be read as an `byte[]` object (with `getBytes`) or a `String` object (with `get`).

*Throws* `NullPointerException`– if key or value is null.

`IllegalStateException`– if this node (or an ancestor) has been removed with the `removeNode()` method.

*See Also* `getBytes(String,byte[])`, `get(String,String)`

#### 106.6.3.20 **public void putDouble(String key,double value)**

*key* key with which the string form of value is to be associated.

*value* value whose string form is to be associated with key.

- Associates a `String` object representing the specified double value with the specified key in this node. The associated `String` object is the one that would be returned if the double value were passed to `Double.toString(double)`. This method is intended for use in conjunction with the `getDouble(String, double)` method

Implementor's note: it is *not* necessary that the value be represented by a string in the backing store. If the backing store supports double values, it is not unreasonable to use them. This implementation detail is not visible through the Preferences API, which allows the value to be read as a double (with `getDouble`) or a `String` (with `get`) type.

*Throws* `NullPointerException`– if key is null.

`IllegalStateException`– if this node (or an ancestor) has been removed with the `removeNode()` method.

*See Also* `getDouble(String,double)`

#### 106.6.3.21 **public void putFloat(String key,float value)**

*key* key with which the string form of value is to be associated.

*value* value whose string form is to be associated with key.

- Associates a `String` object representing the specified float value with the specified key in this node. The associated `String` object is the one that would be returned if the float value were passed to `Float.toString(float)`. This method is intended for use in conjunction with the `getFloat(String, float)` method.

Implementor's note: it is *not* necessary that the value be represented by a string in the backing store. If the backing store supports float values, it is not unreasonable to use them. This implementation detail is not visible through the Preferences API, which allows the value to be read as a float (with `getFloat`) or a `String` (with `get`) type.

*Throws* `NullPointerException`– if key is null.

`IllegalStateException`– if this node (or an ancestor) has been removed with the `removeNode()` method.

*See Also* `getFloat(String,float)`

#### 106.6.3.22 **public void putInt(String key,int value)**

*key* key with which the string form of value is to be associated.

*value* value whose string form is to be associated with key.

- Associates a String object representing the specified int value with the specified key in this node. The associated string is the one that would be returned if the int value were passed to Integer.toString(int). This method is intended for use in conjunction with getInt(String, int) method.

Implementor's note: it is *not* necessary that the property value be represented by a String object in the backing store. If the backing store supports integer values, it is not unreasonable to use them. This implementation detail is not visible through the Preferences API, which allows the value to be read as an int (with getInt or a String (with get) type).

*Throws* NullPointerException– if key is null.

IllegalStateException– if this node (or an ancestor) has been removed with the removeNode() method.

*See Also* getInt(String,int)

### 106.6.3.23      **public void putLong(String key,long value)**

*key* key with which the string form of value is to be associated.

*value* value whose string form is to be associated with key.

- Associates a String object representing the specified long value with the specified key in this node. The associated String object is the one that would be returned if the long value were passed to Long.toString(long). This method is intended for use in conjunction with the getLong(String, long) method.

Implementor's note: it is *not* necessary that the value be represented by a String type in the backing store. If the backing store supports long values, it is not unreasonable to use them. This implementation detail is not visible through the Preferences API, which allows the value to be read as a long (with getLong or a String (with get) type).

*Throws* NullPointerException– if key is null.

IllegalStateException– if this node (or an ancestor) has been removed with the removeNode() method.

*See Also* getLong(String,long)

### 106.6.3.24      **public void remove(String key)**

*key* key whose mapping is to be removed from this node.

- Removes the value associated with the specified key in this node, if any.

*Throws* IllegalStateException– if this node (or an ancestor) has been removed with the removeNode() method.

*See Also* get(String,String)

### 106.6.3.25      **public void removeNode() throws BackingStoreException**

- Removes this node and all of its descendants, invalidating any properties contained in the removed nodes. Once a node has been removed, attempting any method other than name(),absolutePath() or nodeExists("") on the corresponding Preferences instance will fail with an IllegalStateException. (The methods defined on Object can still be invoked on a node after it has been removed; they will not throw IllegalStateException.)

The removal is not guaranteed to be persistent until the flush method is called on the parent of this node.

*Throws* IllegalStateException– if this node (or an ancestor) has already been removed with the removeNode() method.

BackingStoreException– if this operation cannot be completed due to a failure in the backing store, or inability to communicate with it.

*See Also* flush()

#### 106.6.3.26 **public void sync() throws BackingStoreException**

- Ensures that future reads from this node and its descendants reflect any changes that were committed to the persistent store (from any VM) prior to the sync invocation. As a side-effect, forces any changes in the contents of this node and its descendants to the persistent store, as if the flush method had been invoked on this node.

*Throws* BackingStoreException– if this operation cannot be completed due to a failure in the backing store, or inability to communicate with it.

IllegalStateException– if this node (or an ancestor) has been removed with the removeNode() method.

*See Also* flush()

### 106.6.4 **public interface PreferencesService**

The Preferences Service.

Each bundle using this service has its own set of preference trees: one for system preferences, and one for each user.

A PreferencesService object is specific to the bundle which obtained it from the service registry. If a bundle wishes to allow another bundle to access its preferences, it should pass its PreferencesService object to that bundle.

*No Implement* Consumers of this API must not implement this interface

#### 106.6.4.1 **public Preferences getSystemPreferences()**

- Returns the root system node for the calling bundle.

*Returns* The root system node for the calling bundle.

#### 106.6.4.2 **public Preferences getUserPreferences(String name)**

*name* The user for which to return the preference root node.

- Returns the root node for the specified user and the calling bundle.

*Returns* The root node for the specified user and the calling bundle.

#### 106.6.4.3 **public String[] getUsers()**

- Returns the names of users for which node trees exist.

*Returns* The names of users for which node trees exist.

## 106.7 **References**

- [1] *JSR 10 Preferences API*  
<http://www.jcp.org/jsr/detail/10.jsp>
- [2] *RFC 2045 Base 64 encoding*  
<http://www.ietf.org/rfc/rfc2045.txt>

# 107 User Admin Service Specification

## Version 1.1

### 107.1 Introduction

OSGi frameworks are often used in places where end users or devices initiate actions. These kinds of actions inevitably create a need for authenticating the initiator. Authenticating can be done in many different ways, including with passwords, one-time token cards, biometrics, and certificates.

Once the initiator is authenticated, it is necessary to verify that this principal is authorized to perform the requested action. This authorization can only be decided by the operator of the OSGi environment, and thus requires administration.

The User Admin service provides this type of functionality. Bundles can use the User Admin service to authenticate an initiator and represent this authentication as an Authorization object. Bundles that execute actions on behalf of this user can use the Authorization object to verify if that user is authorized.

The User Admin service provides authorization based on who runs the code, instead of using the Java code-based permission model. See [1] *The Java Security Architecture for JDK 1.2*. It performs a role similar to [2] *Java Authentication and Authorization Service*.

#### 107.1.1 Essentials

- *Authentication* - A large number of authentication schemes already exist, and more will be developed. The User Admin service must be flexible enough to adapt to the many different authentication schemes that can be run on a computer system.
- *Authorization* - All bundles should use the User Admin service to authenticate users and to find out if those users are authorized. It is therefore paramount that a bundle can find out authorization information with little effort.
- *Security* - Detailed security, based on the Framework security model, is needed to provide safe access to the User Admin service. It should allow limited access to the credentials and other properties.
- *Extensibility* - Other bundles should be able to build on the User Admin service. It should be possible to examine the information from this service and get real-time notifications of changes.
- *Properties* - The User Admin service must maintain a persistent database of users. It must be possible to use this database to hold more information about this user.
- *Administration* - Administering authorizations for each possible action and initiator is time-consuming and error-prone. It is therefore necessary to have mechanisms to group end users and make it simple to assign authorizations to all members of a group at one time.

#### 107.1.2 Entities

This Specification defines the following User Admin service entities:

- *User Admin* - This interface manages a database of named roles which can be used for authorization and authentication purposes.
- *Role* - This interface exposes the characteristics shared by all roles: a name, a type, and a set of properties.





- *User* - A User object can be configured with credentials, such as a password, and properties, such as address, telephone number, and so on.
- *Group* - A Group object is an aggregation of *basic* and *required* roles. Basic and required roles are used in the authorization phase.

An OSGi framework can have several entry points, each of which will be responsible for authenticating incoming requests. An example of an entry point is the Http Service, which delegates authentication of incoming requests to the `handleSecurity` method of the `HttpContext` object that was specified when the target servlet or resource of the request was registered.

The OSGi framework entry points should use the information in the User Admin service to authenticate incoming requests, such as a password stored in the private credentials or the use of a certificate.

A bundle can determine if a request for an action is authorized by looking for a Role object that has the name of the requested action.

The bundle may execute the action if the Role object representing the initiator *implies* the Role object representing the requested action.

For example, an initiator Role object *X* implies an action Group object *A* if:

- *X* implies at least one of *A*'s basic members, and
- *X* implies all of *A*'s required members.

An initiator Role object *X* implies an action User object *A* if:

- *A* and *X* are equal.

The Authorization class handles this non-trivial logic. The User Admin service can capture the privileges of an authenticated User object into an Authorization object. The `Authorization.hasRole` method checks if the authenticated User object has (or implies) a specified action Role object.

For example, in the case of the Http Service, the `HttpContext` object can authenticate the initiator and place an Authorization object in the request header. The servlet calls the `hasRole` method on this Authorization object to verify that the initiator has the authority to perform a certain action. See *Authentication* on page 52.

## 107.2 Authentication

The authentication phase determines if the initiator is actually the one it says it is. Mechanisms to authenticate always need some information related to the user or the OSGi framework to authenticate an external user. This information can consist of the following:

- A secret known only to the initiator.
- Knowledge about cards that can generate a unique token.
- Public information like certificates of trusted signers.
- Information about the user that can be measured in a trusted way.
- Other specific information.

### 107.2.1 Repository

The User Admin service offers a repository of Role objects. Each Role object has a unique name and a set of properties that are readable by anyone, and are changeable when the changer has the `UserAdminPermission`. Additionally, User objects, a sub-interface of Role, also have a set of private protected properties called credentials. Credentials are an extra set of properties that are used to authenticate users and that are protected by `UserAdminPermission`.

Properties are accessed with the `Role.getProperties()` method and credentials with the `User.getCredentials()` method. Both methods return a Dictionary object containing key/value pairs. The keys are String objects and the values of the Dictionary object are limited to String or byte[ ] objects.

This specification does not define any standard keys for the properties or credentials. The keys depend on the implementation of the authentication mechanism and are not formally defined by OSGi specifications.

The repository can be searched for objects that have a unique property (key/value pair) with the method `UserAdmin.getUser(String,String)`. This makes it easy to find a specific user related to a specific authentication mechanism. For example, a secure card mechanism that generates unique tokens could have a serial number identifying the user. The owner of the card could be found with the method

```
User owner = useradmin.getUser(
    "secure-card-serial", "132456712-1212" );
```

If multiple User objects have the same property (key *and* value), a null is returned.

There is a convenience method to verify that a user has a credential without actually getting the credential. This is the `User.hasCredential(String,Object)` method.

Access to credentials is protected on a name basis by `UserAdminPermission`. Because properties can be read by anyone with access to a User object, `UserAdminPermission` only protects change access to properties.

### 107.2.2 Basic Authentication

The following example shows a very simple authentication algorithm based on passwords.

The vendor of the authentication bundle uses the property "com.acme.basic-id" to contain the name of a user as it logs in. This property is used to locate the User object in the repository. Next, the credential "com.acme.password" contains the password and is compared to the entered password. If the password is correct, the User object is returned. In all other cases a `SecurityException` is thrown.

```
public User authenticate(
    UserAdmin ua, String name, String pwd )
    throws SecurityException {
    User user = ua.getUser("com.acme.basicid",
        username);
    if (user == null)
        throw new SecurityException( "No such user" );

    if (!user.hasCredential("com.acme.password", pwd))
        throw new SecurityException(
            "Invalid password" );
    return user;
}
```

### 107.2.3 Certificates

Authentication based on certificates does not require a shared secret. Instead, a certificate contains a name, a public key, and the signature of one or more signers.

The name in the certificate can be used to locate a User object in the repository. Locating a User object, however, only identifies the initiator and does not authenticate it.

1. The first step to authenticate the initiator is to verify that it has the private key of the certificate.

2. Next, the User Admin service must verify that it has a User object with the right property, for example "com.acme.certificate"="Fudd".
3. The next step is to see if the certificate is signed by a trusted source. The bundle could use a central list of trusted signers and only accept certificates signed by those sources. Alternatively, it could require that the certificate itself is already stored in the repository under a unique key as a byte[] in the credentials.
4. In any case, once the certificate is verified, the associated User object is authenticated.

## 107.3 Authorization

The User Admin service authorization architecture is a *role-based model*. In this model, every action that can be performed by a bundle is associated with a *role*. Such a role is a Group object (called group from now on) from the User Admin service repository. For example, if a servlet could be used to activate the alarm system, there should be a group named AlarmSystemActivation.

The operator can administrate authorizations by populating the group with User objects (users) and other groups. Groups are used to minimize the amount of administration required. For example, it is easier to create one Administrators group and add administrative roles to it rather than individually administer all users for each role. Such a group requires only one action to remove or add a user as an administrator.

The authorization decision can now be made in two fundamentally different ways:

An initiator could be allowed to carry out an action (represented by a Group object) if it implied any of the Group object's members. For example, the AlarmSystemActivation Group object contains an Administrators and a Family Group object:

```
Administrators      = { Elmer, Pepe, Bugs }
Family              = { Elmer, Pepe, Daffy }

AlarmSystemActivation = { Administrators, Family }
```

Any of the four members Elmer, Pepe, Daffy, or Bugs can activate the alarm system.

Alternatively, an initiator could be allowed to perform an action (represented by a Group object) if it implied *all* the Group object's members. In this case, using the same AlarmSystemActivation group, only Elmer and Pepe would be authorized to activate the alarm system, since Daffy and Bugs are *not* members of *both* the Administrators and Family Group objects.

The User Admin service supports a combination of both strategies by defining both a set of *basic members* (any) and a set of *required members* (all).

```
Administrators      = { Elmer, Pepe, Bugs }
Family              = { Elmer, Pepe, Daffy }

AlarmSystemActivation
  required          = { Administrators }
  basic             = { Family }
```

The difference is made when Role objects are added to the Group object. To add a basic member, use the Group.addMember(Role) method. To add a required member, use the Group.addRequiredMember(Role) method.

Basic members define the set of members that can get access and required members reduce this set by requiring the initiator to *imply* each required member.

A User object implies a Group object if it implies the following:

- *All* of the Group's required members, and
- At *least* one of the Group's basic members

A User object always implies itself.

If only required members are used to qualify the implication, then the standard user Role.`USER_ANYONE` can be obtained from the User Admin service and added to the Group object. This Role object is implied by anybody and therefore does not affect the required members.

### 107.3.1 The Authorization Object

The complexity of authorization is hidden in an Authorization class. Normally, the authenticator should retrieve an Authorization object from the User Admin service by passing the authenticated User object as an argument. This Authorization object is then passed to the bundle that performs the action. This bundle checks the authorization with the `Authorization.hasRole(String)` method. The performing bundle must pass the name of the action as an argument. The Authorization object checks whether the authenticated user implies the Role object, specifically a Group object, with the given name. This is shown in the following example.

```
public void activateAlarm(Authorization auth) {
    if ( auth.hasRole( "AlarmSystemActivation" ) ) {
        // activate the alarm
        ...
    }
    else throw new SecurityException(
        "Not authorized to activate alarm" );
}
```

### 107.3.2 Authorization Example

This section demonstrates a possible use of the User Admin service. The service has a flexible model and many other schemes are possible.

Assume an Operator installs an OSGi framework. Bundles in this environment have defined the following action groups:

```
AlarmSystemControl
InternetAccess
TemperatureControl
PhotoAlbumEdit
PhotoAlbumView
PortForwarding
```

Installing and uninstalling bundles could potentially extend this set. Therefore, the Operator also defines a number of groups that can be used to contain the different types of system users.

```
Administrators
Buddies
Children
Adults
Residents
```

In a particular instance, the Operator installs it in a household with the following residents and buddies:

```
Residents:      Elmer, Fudd, Marvin, Pepe
Buddies:        Daffy, Foghorn
```

First, the residents and buddies are assigned to the system user groups. Second, the user groups need to be assigned to the action groups.

The following tables show how the groups could be assigned.

Table 107.1 *Example Groups with Basic and Required Members*

Groups	Elmer	Fudd	Marvin	Pepe	Daffy	Foghorn
Residents	Basic	Basic	Basic	Basic	-	-
Buddies	-	-	-	-	Basic	Basic
Children	-	-	Basic	Basic	-	-
Adults	Basic	Basic	-	-	-	-
Administrators	Basic	-	-	-	-	-

Table 107.2 *Example Action Groups with their Basic and Required Members*

Groups	Residents	Buddies	Children	Adults	Admin
AlarmSystemControl	Basic	-	-	-	Required
InternetAccess	Basic	-	-	Required	-
TemperatureControl	Basic	-	-	Required	-
PhotoAlbumEdit	Basic	-	Basic	Basic	-
PhotoAlbumView	Basic	Basic	-	-	-
PortForwarding	Basic	-	-	-	Required

## 107.4 Repository Maintenance

The UserAdmin interface is a straightforward API to maintain a repository of User and Group objects. It contains methods to create new Group and User objects with the createRole(String,int) method. The method is prepared so that the same signature can be used to create new types of roles in the future. The interface also contains a method to remove a Role object.

The existing configuration can be obtained with methods that list all Role objects using a filter argument. This filter, which has the same syntax as the Framework filter, must only return the Role objects for which the filter matches the properties.

Several utility methods simplify getting User objects depending on their properties.

## 107.5 User Admin Events

Changes in the User Admin service can be determined in real time. Each User Admin service implementation must send a UserAdminEvent object to any service in the Framework service registry that is registered under the UserAdminListener interface. This event must be send asynchronously from the cause of the event. The way events must be delivered is the same as described in *Delivering Events of OSGi Core Release 6*.

This procedure is demonstrated in the following code sample.

```
class Listener implements UserAdminListener{
    public void roleChanged( UserAdminEvent event ) {
        ...
    }
}
public class MyActivator
    implements BundleActivator {
    public void start( BundleContext context ) {
        context.registerService(
            UserAdminListener.class.getName(),
```

```
        new Listener(), null );
    }
    public void stop( BundleContext context ) {}
}
```

It is not necessary to unregister the listener object when the bundle is stopped because the Framework automatically unregisters it. Once registered, the `UserAdminListener` object must be notified of all changes to the role repository.

### 107.5.1 Event Admin and User Admin Change Events

User Admin events must be delivered asynchronously to the Event Admin service by the implementation, if present. The topic of a User Admin Event is:

```
org.osgi/service/useradmin/UserAdmin/<eventtype>
```

The following event types are supported:

```
ROLE_CREATED
ROLE_CHANGED
ROLE_REMOVED
```

All User Admin Events must have the following properties:

- `event` - (`UserAdminEvent`) The event that was broadcast by the User Admin service.
- `role` - (`Role`) The Role object that was created, modified or removed.
- `role.name` - (`String`) The name of the role.
- `role.type` - (`Integer`) One of `ROLE`, `USER` or `GROUP`.
- `service` - (`ServiceReference`) The Service Reference of the User Admin service.
- `service.id` - (`Long`) The User Admin service's ID.
- `service.objectClass` - (`String[]`) The User Admin service's object class (which must include `org.osgi.service.useradmin.UserAdmin`)
- `service.pid` - (`String`) The User Admin service's persistent identity

## 107.6 Security

The User Admin service is related to the security model of the OSGi framework, but is complementary to the [1] *The Java Security Architecture for JDK 1.2*. The final permission of most code should be the intersection of the Java 2 Permissions, which are based on the code that is executing, and the User Admin service authorization, which is based on the user for whom the code runs.

### 107.6.1 User Admin Permission

The User Admin service defines the `UserAdminPermission` class that can be used to restrict bundles in accessing credentials. This permission class has the following actions:

- `changeProperty` - This permission is required to modify properties. The name of the permission is the prefix of the property name.
- `changeCredential` - This action permits changing credentials. The name of the permission is the prefix of the name of the credential.
- `getCredential` - This action permits getting credentials. The name of the permission is the prefix of the credential.

If the name of the permission is "admin", it allows the owner to administer the repository. No action is associated with the permission in that case.

Otherwise, the permission name is used to match the property name. This name may end with a "." string to indicate a wildcard. For example, `com.acme.*` matches `com.acme.fudd.elmer` and `com.acme.bugs`.

## 107.7 Relation to JAAS

At a glance, the Java Authorization and Authentication Service (JAAS) seems to be a very suitable model for user administration. The OSGi organization, however, decided to develop an independent User Admin service because JAAS was not deemed applicable. The reasons for this include dependency on Java SE version 1.3 ("JDK 1.3") and existing mechanisms in the previous OSGi Service Gateway 1.0 specification.

### 107.7.1 JDK 1.3 Dependencies

The authorization component of JAAS relies on the `java.security.DomainCombiner` interface, which provides a means to dynamically update the `ProtectionDomain` objects affiliated with an `AccessControlContext` object.

This interface was added in JDK 1.3. In the context of JAAS, the `SubjectDomainCombiner` object, which implements the `DomainCombiner` interface, is used to update `ProtectionDomain` objects. The permissions of `ProtectionDomain` objects depend on where code came from and who signed it, with permissions based on who is running the code.

Leveraging JAAS would have resulted in user-based access control on the OSGi framework being available only with JDK 1.3, which was not deemed acceptable.

### 107.7.2 Existing OSGi Mechanism

JAAS provides a pluggable authentication architecture, which enables applications and their underlying authentication services to remain independent from each other.

The `Http Service` already provides a similar feature by allowing servlet and resource registrations to be supported by an `HttpContext` object, which uses a callback mechanism to perform any required authentication checks before granting access to the servlet or resource. This way, the registering bundle has complete control on a per-servlet and per-resource basis over which authentication protocol to use, how the credentials presented by the remote requester are to be validated, and who should be granted access to the servlet or resource.

### 107.7.3 Future Road Map

In the future, the main barrier of 1.3 compatibility will be removed. JAAS could then be implemented in an OSGi environment. At that time, the User Admin service will still be needed and will provide complementary services in the following ways:

- The authorization component relies on group membership information to be stored and managed outside JAAS. JAAS does not manage persistent information, so the User Admin service can be a provider of group information when principals are assigned to a `Subject` object.
- The authorization component allows for credentials to be collected and verified, but a repository is needed to actually validate the credentials.

In the future, the User Admin service can act as the back-end database to JAAS. The only aspect JAAS will remove from the User Admin service is the need for the `Authorization` interface.

## 107.8 org.osgi.service.useradmin

User Admin Package Version 1.1.

Bundles wishing to use this package must list the package in the Import-Package header of the bundle's manifest. This package has two types of users: the consumers that use the API in this package and the providers that implement the API in this package.

Example import for consumers using the API in this package:

```
Import-Package: org.osgi.service.useradmin; version="[1.1,2.0]"
```

Example import for providers implementing the API in this package:

```
Import-Package: org.osgi.service.useradmin; version="[1.1,1.2]"
```

## 107.8.1

### Summary

- Authorization - The Authorization interface encapsulates an authorization context on which bundles can base authorization decisions, where appropriate.
- Group - A named grouping of roles (Role objects).
- Role - The base interface for Role objects managed by the User Admin service.
- User - A User role managed by a User Admin service.
- UserAdmin - This interface is used to manage a database of named Role objects, which can be used for authentication and authorization purposes.
- UserAdminEvent - Role change event.
- UserAdminListener - Listener for UserAdminEvents.
- UserAdminPermission - Permission to configure and access the Role objects managed by a User Admin service.

## 107.8.2

### public interface Authorization

The Authorization interface encapsulates an authorization context on which bundles can base authorization decisions, where appropriate.

Bundles associate the privilege to access restricted resources or operations with roles. Before granting access to a restricted resource or operation, a bundle will check if the Authorization object passed to it possess the required role, by calling its hasRole method.

Authorization contexts are instantiated by calling the UserAdmin.getAuthorization(User) method.

#### *Trusting Authorization objects*

There are no restrictions regarding the creation of Authorization objects. Hence, a service must only accept Authorization objects from bundles that has been authorized to use the service using code based (or Java 2) permissions.

In some cases it is useful to use ServicePermission to do the code based access control. A service basing user access control on Authorization objects passed to it, will then require that a calling bundle has the ServicePermission to get the service in question. This is the most convenient way. The OSGi environment will do the code based permission check when the calling bundle attempts to get the service from the service registry.

Example: A servlet using a service on a user's behalf. The bundle with the servlet must be given the ServicePermission to get the Http Service.

However, in some cases the code based permission checks need to be more fine-grained. A service might allow all bundles to get it, but require certain code based permissions for some of its methods.

Example: A servlet using a service on a user's behalf, where some service functionality is open to anyone, and some is restricted by code based permissions. When a restricted method is called (e.g., one handing over an Authorization object), the service explicitly checks that the calling bundle has permission to make the call.



*No Implement* Consumers of this API must not implement this interface

#### 107.8.2.1 **public String getName()**

- Gets the name of the User that this Authorization context was created for.

*Returns* The name of the User object that this Authorization context was created for, or null if no user was specified when this Authorization context was created.

#### 107.8.2.2 **public String[] getRoles()**

- Gets the names of all roles implied by this Authorization context.

*Returns* The names of all roles implied by this Authorization context, or null if no roles are in the context. The predefined role `user.anyone` will not be included in this list.

#### 107.8.2.3 **public boolean hasRole(String name)**

*name* The name of the role to check for.

- Checks if the role with the specified name is implied by this Authorization context.

Bundles must define globally unique role names that are associated with the privilege of accessing restricted resources or operations. Operators will grant users access to these resources, by creating a Group object for each role and adding User objects to it.

*Returns* true if this Authorization context implies the specified role, otherwise false.

### 107.8.3 **public interface Group extends User**

A named grouping of roles (Role objects).

Whether or not a given Authorization context implies a Group object depends on the members of that Group object.

A Group object can have two kinds of members: *basic* and *required*. A Group object is implied by an Authorization context if all of its required members are implied and at least one of its basic members is implied.

A Group object must contain at least one basic member in order to be implied. In other words, a Group object without any basic member roles is never implied by any Authorization context.

A User object always implies itself.

No loop detection is performed when adding members to Group objects, which means that it is possible to create circular implications. Loop detection is instead done when roles are checked. The semantics is that if a role depends on itself (i.e., there is an implication loop), the role is not implied.

The rule that a Group object must have at least one basic member to be implied is motivated by the following example:

```
group foo
  required members: marketing
  basic members: alice, bob
```

Privileged operations that require membership in "foo" can be performed only by "alice" and "bob", who are in marketing.

If "alice" and "bob" ever transfer to a different department, anybody in marketing will be able to assume the "foo" role, which certainly must be prevented. Requiring that "foo" (or any Group object for that matter) must have at least one basic member accomplishes that.

However, this would make it impossible for a Group object to be implied by just its required members. An example where this implication might be useful is the following declaration: "Any citizen who is an adult is allowed to vote." An intuitive configuration of "voter" would be:

```
group voter
  required members: citizen, adult
  basic members:
```

However, according to the above rule, the "voter" role could never be assumed by anybody, since it lacks any basic members. In order to address this issue a predefined role named "user.anyone" can be specified, which is always implied. The desired implication of the "voter" group can then be achieved by specifying "user.anyone" as its basic member, as follows:

```
group voter
  required members: citizen, adult
  basic members: user.anyone
```

*No Implement* Consumers of this API must not implement this interface

#### 107.8.3.1 **public boolean addMember(Role role)**

*role* The role to add as a basic member.

- Adds the specified Role object as a basic member to this Group object.

*Returns* true if the given role could be added as a basic member, and false if this Group object already contains a Role object whose name matches that of the specified role.

*Throws* SecurityException– If a security manager exists and the caller does not have the UserAdminPermission with name admin.

#### 107.8.3.2 **public boolean addRequiredMember(Role role)**

*role* The Role object to add as a required member.

- Adds the specified Role object as a required member to this Group object.

*Returns* true if the given Role object could be added as a required member, and false if this Group object already contains a Role object whose name matches that of the specified role.

*Throws* SecurityException– If a security manager exists and the caller does not have the UserAdminPermission with name admin.

#### 107.8.3.3 **public Role[] getMembers()**

- Gets the basic members of this Group object.

*Returns* The basic members of this Group object, or null if this Group object does not contain any basic members.

#### 107.8.3.4 **public Role[] getRequiredMembers()**

- Gets the required members of this Group object.

*Returns* The required members of this Group object, or null if this Group object does not contain any required members.

#### 107.8.3.5 **public boolean removeMember(Role role)**

*role* The Role object to remove from this Group object.

- Removes the specified Role object from this Group object.

*Returns* true if the Role object could be removed, otherwise false.

*Throws* SecurityException—If a security manager exists and the caller does not have the UserAdminPermission with name admin.

#### 107.8.4 public interface Role

The base interface for Role objects managed by the User Admin service.

This interface exposes the characteristics shared by all Role classes: a name, a type, and a set of properties.

Properties represent public information about the Role object that can be read by anyone. Specific UserAdminPermission objects are required to change a Role object's properties.

Role object properties are Dictionary objects. Changes to these objects are propagated to the User Admin service and made persistent.

Every User Admin service contains a set of predefined Role objects that are always present and cannot be removed. All predefined Role objects are of type ROLE. This version of the org.osgi.service.useradmin package defines a single predefined role named "user.anyone", which is inherited by any other role. Other predefined roles may be added in the future. Since "user.anyone" is a Role object that has properties associated with it that can be read and modified. Access to these properties and their use is application specific and is controlled using UserAdminPermission in the same way that properties for other Role objects are.

*No Implement* Consumers of this API must not implement this interface

##### 107.8.4.1 public static final int GROUP = 2

The type of a Group role.

The value of GROUP is 2.

##### 107.8.4.2 public static final int ROLE = 0

The type of a predefined role.

The value of ROLE is 0.

##### 107.8.4.3 public static final int USER = 1

The type of a User role.

The value of USER is 1.

##### 107.8.4.4 public static final String USER\_ANYONE = "user.anyone"

The name of the predefined role, user.anyone, that all users and groups belong to.

*Since* 1.1

##### 107.8.4.5 public String getName()

- Returns the name of this role.

*Returns* The role's name.

##### 107.8.4.6 public Dictionary getProperties()

- Returns a Dictionary of the (public) properties of this Role object. Any changes to the returned Dictionary will change the properties of this Role object. This will cause a UserAdminEvent object of type UserAdminEvent.ROLE\_CHANGED to be broadcast to any UserAdminListener objects.

Only objects of type String may be used as property keys, and only objects of type String or byte[] may be used as property values. Any other types will cause an exception of type IllegalArgumentException to be raised.

In order to add, change, or remove a property in the returned Dictionary, a `UserAdminPermission` named after the property name (or a prefix of it) with action `changeProperty` is required.

*Returns* Dictionary containing the properties of this Role object.

#### 107.8.4.7 **public int getType()**

- Returns the type of this role.

*Returns* The role's type.

### 107.8.5 **public interface User extends Role**

A User role managed by a User Admin service.

In this context, the term "user" is not limited to just human beings. Instead, it refers to any entity that may have any number of credentials associated with it that it may use to authenticate itself.

In general, User objects are associated with a specific User Admin service (namely the one that created them), and cannot be used with other User Admin services.

A User object may have credentials (and properties, inherited from the Role class) associated with it. Specific `UserAdminPermission` objects are required to read or change a User object's credentials.

Credentials are Dictionary objects and have semantics that are similar to the properties in the Role class.

*No Implement* Consumers of this API must not implement this interface

#### 107.8.5.1 **public Dictionary getCredentials()**

- Returns a Dictionary of the credentials of this User object. Any changes to the returned Dictionary object will change the credentials of this User object. This will cause a `UserAdminEvent` object of type `UserAdminEvent.ROLE_CHANGED` to be broadcast to any `UserAdminListeners` objects.

Only objects of type `String` may be used as credential keys, and only objects of type `String` or of type `byte[]` may be used as credential values. Any other types will cause an exception of type `IllegalArgumentException` to be raised.

In order to retrieve a credential from the returned Dictionary object, a `UserAdminPermission` named after the credential name (or a prefix of it) with action `getCredential` is required.

In order to add or remove a credential from the returned Dictionary object, a `UserAdminPermission` named after the credential name (or a prefix of it) with action `changeCredential` is required.

*Returns* Dictionary object containing the credentials of this User object.

#### 107.8.5.2 **public boolean hasCredential(String key, Object value)**

*key* The credential key.

*value* The credential value.

- Checks to see if this User object has a credential with the specified key set to the specified value.

If the specified credential value is not of type `String` or `byte[]`, it is ignored, that is, `false` is returned (as opposed to an `IllegalArgumentException` being raised).

*Returns* `true` if this user has the specified credential; `false` otherwise.

*Throws* `SecurityException`– If a security manager exists and the caller does not have the `UserAdminPermission` named after the credential key (or a prefix of it) with action `getCredential`.

**107.8.6 public interface UserAdmin**

This interface is used to manage a database of named Role objects, which can be used for authentication and authorization purposes.

This version of the User Admin service defines two types of Role objects: "User" and "Group". Each type of role is represented by an int constant and an interface. The range of positive integers is reserved for new types of roles that may be added in the future. When defining proprietary role types, negative constant values must be used.

Every role has a name and a type.

A User object can be configured with credentials (e.g., a password) and properties (e.g., a street address, phone number, etc.).

A Group object represents an aggregation of User and Group objects. In other words, the members of a Group object are roles themselves.

Every User Admin service manages and maintains its own namespace of Role objects, in which each Role object has a unique name.

*No Implement* Consumers of this API must not implement this interface

**107.8.6.1 public Role createRole(String name,int type)**

*name* The name of the Role object to create.

*type* The type of the Role object to create. Must be either a Role.USER type or Role.GROUP type.

- Creates a Role object with the given name and of the given type.

If a Role object was created, a UserAdminEvent object of type UserAdminEvent.ROLE\_CREATED is broadcast to any UserAdminListener object.

*Returns* The newly created Role object, or null if a role with the given name already exists.

*Throws* IllegalArgumentException– if type is invalid.

SecurityException– If a security manager exists and the caller does not have the UserAdminPermission with name admin.

**107.8.6.2 public Authorization getAuthorization(User user)**

*user* The User object to create an Authorization object for, or null for the anonymous user.

- Creates an Authorization object that encapsulates the specified User object and the Role objects it possesses. The null user is interpreted as the anonymous user. The anonymous user represents a user that has not been authenticated. An Authorization object for an anonymous user will be unnamed, and will only imply groups that user.anyone implies.

*Returns* the Authorization object for the specified User object.

**107.8.6.3 public Role getRole(String name)**

*name* The name of the Role object to get.

- Gets the Role object with the given name from this User Admin service.

*Returns* The requested Role object, or null if this User Admin service does not have a Role object with the given name.

**107.8.6.4 public Role[] getRoles(String filter) throws InvalidSyntaxException**

*filter* The filter criteria to match.

- Gets the Role objects managed by this User Admin service that have properties matching the specified LDAP filter criteria. See org.osgi.framework.Filter for a description of the filter syntax. If a null filter is specified, all Role objects managed by this User Admin service are returned.

*Returns* The Role objects managed by this User Admin service whose properties match the specified filter criteria, or all Role objects if a null filter is specified. If no roles match the filter, null will be returned.

*Throws* InvalidSyntaxException– If the filter is not well formed.

#### 107.8.6.5 **public User getUser(String key,String value)**

*key* The property key to look for.

*value* The property value to compare with.

- Gets the user with the given property key-value pair from the User Admin service database. This is a convenience method for retrieving a User object based on a property for which every User object is supposed to have a unique value (within the scope of this User Admin service), such as for example a X.500 distinguished name.

*Returns* A matching user, if *exactly* one is found. If zero or more than one matching users are found, null is returned.

#### 107.8.6.6 **public boolean removeRole(String name)**

*name* The name of the Role object to remove.

- Removes the Role object with the given name from this User Admin service and all groups it is a member of.

If the Role object was removed, a UserAdminEvent object of type UserAdminEvent.ROLE\_REMOVED is broadcast to any UserAdminListener object.

*Returns* true If a Role object with the given name is present in this User Admin service and could be removed, otherwise false.

*Throws* SecurityException– If a security manager exists and the caller does not have the UserAdminPermission with name admin.

### 107.8.7 **public class UserAdminEvent**

Role change event.

UserAdminEvent objects are delivered asynchronously to any UserAdminListener objects when a change occurs in any of the Role objects managed by a User Admin service.

A type code is used to identify the event. The following event types are defined: ROLE\_CREATED type, ROLE\_CHANGED type, and ROLE\_REMOVED type. Additional event types may be defined in the future.

*See Also* UserAdmin, UserAdminListener

#### 107.8.7.1 **public static final int ROLE\_CHANGED = 2**

A Role object has been modified.

The value of ROLE\_CHANGED is 0x00000002.

#### 107.8.7.2 **public static final int ROLE\_CREATED = 1**

A Role object has been created.

The value of ROLE\_CREATED is 0x00000001.

#### 107.8.7.3 **public static final int ROLE\_REMOVED = 4**

A Role object has been removed.

The value of ROLE\_REMOVED is 0x00000004.

**107.8.7.4      public UserAdminEvent(ServiceReference ref,int type,Role role)**

*ref* The ServiceReference object of the User Admin service that generated this event.

*type* The event type.

*role* The Role object on which this event occurred.

- Constructs a UserAdminEvent object from the given ServiceReference object, event type, and Role object.

**107.8.7.5      public Role getRole()**

- Gets the Role object this event was generated for.

*Returns* The Role object this event was generated for.

**107.8.7.6      public ServiceReference getServiceReference()**

- Gets the ServiceReference object of the User Admin service that generated this event.

*Returns* The User Admin service's ServiceReference object.

**107.8.7.7      public int getType()**

- Returns the type of this event.

The type values are ROLE\_CREATED type, ROLE\_CHANGED type, and ROLE\_REMOVED type.

*Returns* The event type.

**107.8.8      public interface UserAdminListener**

Listener for UserAdminEvents.

UserAdminListener objects are registered with the Framework service registry and notified with a UserAdminEvent object when a Role object has been created, removed, or modified.

UserAdminListener objects can further inspect the received UserAdminEvent object to determine its type, the Role object it occurred on, and the User Admin service that generated it.

*See Also* UserAdmin, UserAdminEvent

**107.8.8.1      public void roleChanged(UserAdminEvent event)**

*event* The UserAdminEvent object.

- Receives notification that a Role object has been created, removed, or modified.

**107.8.9      public final class UserAdminPermission  
extends BasicPermission**

Permission to configure and access the Role objects managed by a User Admin service.

This class represents access to the Role objects managed by a User Admin service and their properties and credentials (in the case of User objects).

The permission name is the name (or name prefix) of a property or credential. The naming convention follows the hierarchical property naming convention. Also, an asterisk may appear at the end of the name, following a ".", or by itself, to signify a wildcard match. For example: "org.osgi.security.protocol.\*" or "\*" is valid, but "\*protocol" or "a\*b" are not valid.

The UserAdminPermission with the reserved name "admin" represents the permission required for creating and removing Role objects in the User Admin service, as well as adding and removing members in a Group object. This UserAdminPermission does not have any actions associated with it.

The actions to be granted are passed to the constructor in a string containing a list of one or more comma-separated keywords. The possible keywords are: `changeProperty`, `changeCredential`, and `getCredential`. Their meaning is defined as follows:

<code>action</code>	
<code>changeProperty</code>	Permission to change (i.e., add and remove) Role object properties whose names start with the name argument specified in the constructor.
<code>changeCredential</code>	Permission to change (i.e., add and remove) User object credentials whose names start with the name argument specified in the constructor.
<code>getCredential</code>	Permission to retrieve and check for the existence of User object credentials whose names start with the name argument specified in the constructor.

The action string is converted to lowercase before processing.

Following is a `PermissionInfo` style policy entry which grants a user administration bundle a number of `UserAdminPermission` object:

```
(org.osgi.service.useradmin.UserAdminPermission "admin")
(org.osgi.service.useradmin.UserAdminPermission "com.foo.*"
    "changeProperty, getCredential, changeCredential")
(org.osgi.service.useradmin.UserAdminPermission "user.*"
    "changeProperty, changeCredential")
```

The first permission statement grants the bundle the permission to perform any User Admin service operations of type "admin", that is, create and remove roles and configure Group objects.

The second permission statement grants the bundle the permission to change any properties as well as get and change any credentials whose names start with `com.foo..`

The third permission statement grants the bundle the permission to change any properties and credentials whose names start with `user..`. This means that the bundle is allowed to change, but not retrieve any credentials with the given prefix.

The following policy entry empowers the Http Service bundle to perform user authentication:

```
grant codeBase "${jars}http.jar" {
    permission org.osgi.service.useradmin.UserAdminPermission
        "user.password", "getCredential";
};
```

The permission statement grants the Http Service bundle the permission to validate any password credentials (for authentication purposes), but the bundle is not allowed to change any properties or credentials.

*Concurrency* Thread-safe

**107.8.9.1**      **public static final String ADMIN = "admin"**

The permission name "admin".

**107.8.9.2**      **public static final String CHANGE\_CREDENTIAL = "changeCredential"**

The action string "changeCredential".

**107.8.9.3**      **public static final String CHANGE\_PROPERTY = "changeProperty"**

The action string "changeProperty".



**107.8.9.4      public static final String GET\_CREDENTIAL = "getCredential"**

The action string "getCredential".

**107.8.9.5      public UserAdminPermission(String name,String actions)**

*name* the name of this UserAdminPermission

*actions* the action string.

- Creates a new UserAdminPermission with the specified name and actions. name is either the reserved string "admin" or the name of a credential or property, and actions contains a comma-separated list of the actions granted on the specified name. Valid actions are changeProperty,changeCredential, and getCredential.

*Throws* IllegalArgumentException– If name equals "admin" and actions are specified.

**107.8.9.6      public boolean equals(Object obj)**

*obj* the object to be compared for equality with this object.

- Checks two UserAdminPermission objects for equality. Checks that obj is a UserAdminPermission, and has the same name and actions as this object.

*Returns* true if obj is a UserAdminPermission object, and has the same name and actions as this UserAdmin-Permission object.

**107.8.9.7      public String getActions()**

- Returns the canonical string representation of the actions, separated by comma.

*Returns* the canonical string representation of the actions.

**107.8.9.8      public int hashCode()**

- Returns the hash code value for this object.

*Returns* A hash code value for this object.

**107.8.9.9      public boolean implies(Permission p)**

*p* the permission to check against.

- Checks if this UserAdminPermission object "implies" the specified permission.

More specifically, this method returns true if:

- *p* is an instance of UserAdminPermission,
- *p*'s actions are a proper subset of this object's actions, and
- *p*'s name is implied by this object's name. For example, "java.\*" implies "java.home".

*Returns* true if the specified permission is implied by this object; false otherwise.

**107.8.9.10      public PermissionCollection newPermissionCollection()**

- Returns a new PermissionCollection object for storing UserAdminPermission objects.

*Returns* a new PermissionCollection object suitable for storing UserAdminPermission objects.

**107.8.9.11      public String toString()**

- Returns a string describing this UserAdminPermission object. This string must be in PermissionInfo encoded format.

*Returns* The PermissionInfo encoded string for this UserAdminPermission object.

*See Also* org.osgi.service.permissionadmin.PermissionInfo.getEncoded()

## 107.9 References

- [1] *The Java Security Architecture for JDK 1.2*  
Version 1.0, Sun Microsystems, October 1998
- [2] *Java Authentication and Authorization Service*  
<http://www.oracle.com/technetwork/java/javase/tech/index-jsp-136007.html>

# 108 Wire Admin Service Specification

## Version 1.0

### 108.1 Introduction

The Wire Admin service is an administrative service that is used to control a wiring topology in the OSGi Framework. It is intended to be used by user interfaces or management programs that control the wiring of services in an OSGi Framework.

The Wire Admin service plays a crucial role in minimizing the amount of context-specific knowledge required by bundles when used in a large array of configurations. The Wire Admin service fulfills this role by dynamically *wiring* services together. Bundles participate in this wiring process by registering services that produce or consume data. The Wire Admin service *wires* the services that produce data to services which consume data.

The purpose of wiring services together is to allow configurable cooperation of bundles in an OSGi Framework. For example, a temperature sensor can be connected to a heating module to provide a controlled system.

The Wire Admin service is a very important OSGi configuration service and is designed to cooperate closely with the Configuration Admin service, as defined in *Configuration Admin Service Specification* on page 87.

#### 108.1.1 Wire Admin Service Essentials

- *Topology Management* - Provide a comprehensive mechanism to link data-producing components with data-consuming components in an OSGi environment.
- *Configuration Management* - Contains configuration data in order to allow either party to adapt to the special needs of the wire.
- *Data Type Handling* - Facilitate the negotiation of the data type to be used for data transfer between producers of data and consumers of data. Consumers and producers must be able to handle multiple data types for data exchanges using a preferred order.
- *Composites* - Support producers and consumers that can handle a large number of data items.
- *Security* - Separate connected parties from each other. Each party must not be required to hold the service object of the other party.
- *Simplicity* - The interfaces should be designed so that both parties, the Producer and the Consumer services, should be easy to implement.

#### 108.1.2 Wire Admin Service Entities

- *Producer* - A service object that generates information to be used by a Consumer service.
- *Consumer* - A service object that receives information generated by a Producer service.
- *Wire* - An object created by the Wire Admin service that defines an association between a Producer service and a Consumer service. Multiple Wire objects can exist between the same Producer and Consumer pair.
- *WireAdmin* - The service that provides methods to create, update, remove, and list Wire objects.
- *WireAdminListener* - A service that receives events from the Wire Admin service when the Wire object is manipulated or used.

- *WireAdminEvent* - The event that is sent to a *WireAdminListener* object, describing the details of what happened.
- *Configuration Properties* - Properties that are associated with a *Wire* object and that contain identity and configuration information set by the administrator of the Wire Admin service.
- *PID* - The Persistent IDentity as defined in the Configuration Admin specification.
- *Flavors* - The different data types that can be used to exchange information between Producer and Consumer services.
- *Composite Producer/Consumer* - A Producer/Consumer service that can generate/accept different kinds of values.
- *Envelope* - An interface for objects that can identify a value that is transferred over the wire. Envelope objects contain also a scope name that is used to verify access permissions.
- *Scope* - A set of names that categorizes the kind of values contained in Envelope objects for security and selection purposes.
- *Basic Envelope* - A concrete implementation of the Envelope interface.
- *WirePermission* - A Permission sub-class that is used to verify if a Consumer service or Producer service has permission for specific scope names.
- *Composite Identity* - A name that is agreed between a composite Consumer and Producer service to identify the kind of objects that they can exchange.

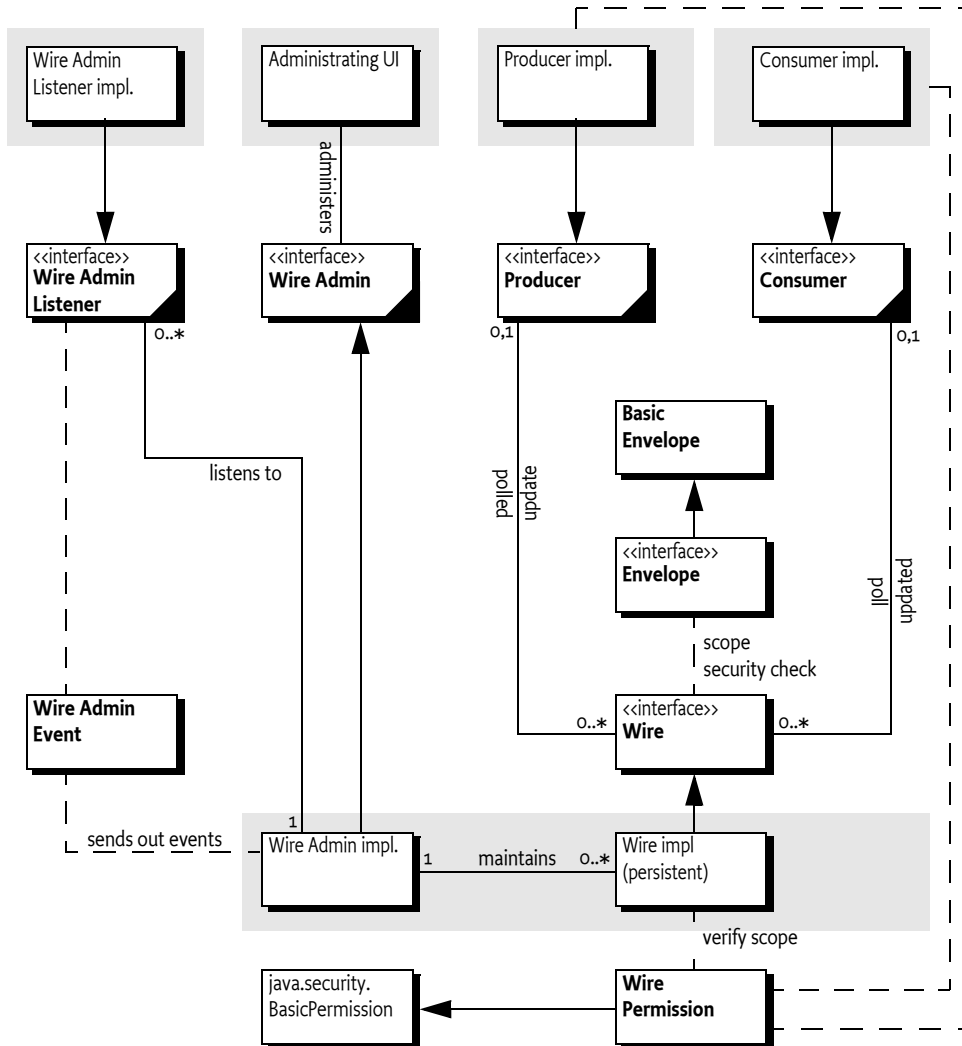
Figure 108.1 Class Diagram, *org.osgi.service.wireadmin*

### 108.1.3 Operation Summary

The Wire Admin service maintains a set of persistent Wire objects. A Wire object contains a Persistent IDentity (PID) for a Consumer service and a PID for a Producer service. (Wire objects can therefore be created when the Producer or Consumer service is not registered.)

If both those Producer and Consumer services are registered with the Framework, they are connected by the Wire Admin service. The Wire Admin service calls a method on each service object and provides the list of Wire objects to which they are connected.

When a Producer service has new information, it should send this information to each of the connected Wire objects. Each Wire object then must check the filtering and security. If both filtering and security allow the transfer, the Producer service should inform the associated Consumer service with the new information. The Consumer services can also poll a Wire object for an new value at any time.

When a Consumer or Producer service is unregistered from the OSGi Framework, the other object in the association is informed that the Wire object is no longer valid.

Administrative applications can use the Wire Admin service to create and delete wires. These changes are immediately reflected in the current topology and are broadcast to Wire Admin Listener services.

Figure 108.2 An Example Wiring Scheme in an OSGi Environment

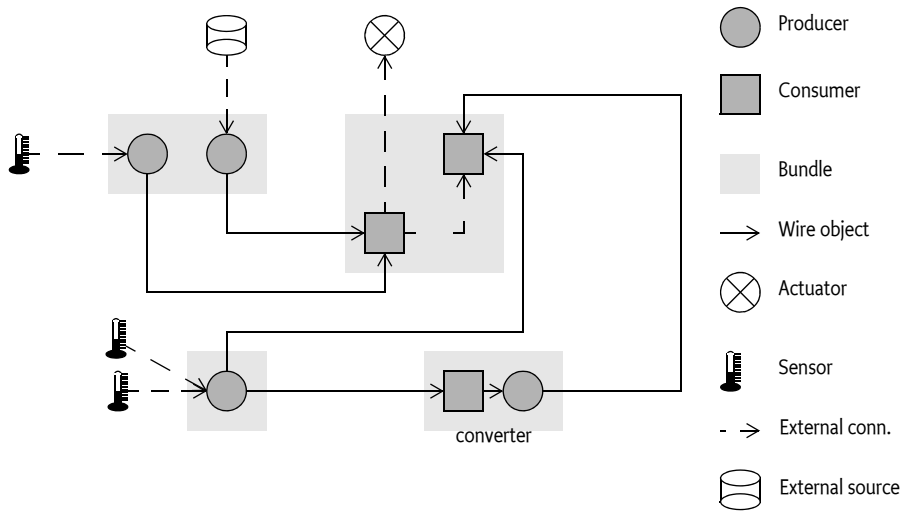

## 108.2 Producer Service

A Producer is a service that can produce a sequence of data objects. For example, a Producer service can produce, among others, the following type of objects:

- Measurement objects that represent a sensor measurement such as temperature, movement, or humidity.
- A String object containing information for user consumption, such as headlines.
- A Date object indicating the occurrence of a periodic event.
- Position information.
- Envelope objects containing status items which can be any type.

### 108.2.1 Producer Properties

A Producer service must be registered with the OSGi Framework under the interface name `org.osgi.service.wireadmin.Producer`. The following service properties must be set:

- `service.pid` - The value of this property, also known as the PID, defines the Persistent IDentity of a service. A Producer service must always use the same PID value whenever it is registered. The PID value allows the Wire Admin service to consistently identify the Producer service and create a persistent Wire object that links a Producer service to a Consumer service. See [1] *Design Patterns* specification for the rules regarding PIDs.
- `wireadmin.producer.flavors` - The value of this property is an array of Class objects (`Class[]`) that are the classes of the objects the service can produce. See *Flavors* on page 214 for more information about the data type negotiation between Producer and Consumer services.
- `wireadmin.producer.filters` - This property indicates to the Wire Admin service that this Producer service performs its own update filtering, meaning that the consumer can limit the number of update calls with a filter expression. This does not modify the data; it only determines whether an update via the wire occurs. If this property is not set, the Wire object must filter according to

the description in *Composite objects* on page 208. This service registration property does not need to have a specific value.

- `wireadmin.producer.scope` - Only for a composite Producer service, a list of scope names that define the scope of this Producer service, as explained in *Scope* on page 209.
- `wireadmin.producer.composite` - List the composite identities of Consumer services with which this Producer service can interoperate. This property is of type `String[]`. A composite Consumer service can inter-operate with a composite Producer service when there is at least one name that occurs in both the Consumer service's array and the Producer service's array for this property.

## 108.2.2 Connections

The Wire Admin service connects a Producer service and a Consumer service by creating a `Wire` object. If the Consumer and Producer services that are bound to a `Wire` object are registered with the Framework, the Wire Admin service must call the `consumersConnected(Wire[])` method on the Producer service object. Every change in the Wire Admin service that affects the `Wire` object to which a Producer service is connected must result in a call to this method. This requirement ensures that the Producer object is informed of its role in the wiring topology. If the Producer service has no `Wire` objects attached when it is registered, the Wire Admin service must always call `consumersConnected(null)`. This situation implies that a Producer service can assume it always gets called back from the Wire Admin service when it registers.

## 108.2.3 Producer Example

The following example shows a clock producer service that sends out a `Date` object every second.

```
public class Clock extends Thread implements Producer {
    Wire        wires[];
    BundleContext context;
    boolean     quit;

    Clock( BundleContext context ) {
        this.context = context;
        start();
    }
    public synchronized void run() {
        Hashtable p = new Hashtable();
        p.put( org.osgi.service.wireadmin.WireConstants.
            WIREADMIN_PRODUCER_FLAVORS,
            new Class[] { Date.class } );
        p.put( org.osgi.framework.Constants.SERVICE_PID,
            "com.acme.clock" );
        context.registerService(
            Producer.class.getName(), this, p );

        while( ! quit )
            try {
                Date now = new Date();
                for( int i=0; wires!=null && i<wires.length;i++ )
                    wires[i].update( now );
                wait( 1000 );
            }
            catch( InterruptedException ie) {
                /* will recheck quit */
            }
    }
    public void synchronized consumersConnected(Wire wires[])
```

```

    {
        this.wires = wires;
    }
    public Object polled(Wire wire) { return new Date(); }
    ...
}

```

### 108.2.4 Push and Pull

Communication between Consumer and Producer services can be initiated in one of the following ways.

- The Producer service calls the `update(Object)` method on the Wire object. The Wire object implementation must then call the `updated(Wire, Object)` method on the Consumer service, if the filtering allows this.
- The Consumer service can call `poll()` on the Wire object. The Wire object must then call `polled(Wire)` on the Producer object. Update filtering must not apply to polling.

### 108.2.5 Producers and Flavors

Consumer services can only understand specific data types, and are therefore restricted in what data they can process. The acceptable object classes, the flavors, are communicated by the Consumer service to the Wire Admin service using the Consumer service's service registration properties. The method `getFlavors()` on the Wire object returns this list of classes. This list is an ordered list in which the first class is the data type that is the most preferred data type supported by the Consumer service. The last class is the least preferred data type. The Producer service must attempt to convert its data into one of the data types according to the preferred order, or will return null from the poll method to the Consumer service if none of the types are recognized.

Classes cannot be easily compared for equivalence. Sub-classes and interfaces allow classes to masquerade as other classes. The `Class.isAssignableFrom(Class)` method verifies whether a class is type compatible, as in the following example:

```

Object polled(Wire wire) {
    Class clazzes[] = wire.getFlavors();
    for ( int i=0; i<clazzes.length; i++ ) {
        Class clazz = clazzes[i];
        if ( clazz.isAssignableFrom( Date.class ) )
            return new Date();
        if ( clazz.isAssignableFrom( String.class ) )
            return new Date().toString();
    }
    return null;
}

```

The order of the if statements defines the preferences of the Producer object. Preferred data types are checked first. This order normally works as expected but in rare cases, sub-classes can change it. Normally, however, that is not a problem.

## 108.3 Consumer Service

A Consumer service is a service that receives information from one or more Producer services and is wired to Producer services by the Wire Admin service. Typical Consumer services are as follows:

- The control of an actuator, such as a heating element, oven, or electric shades
- A display



- A log
- A state controller such as an alarm system

### 108.3.1 Consumer Properties

A Consumer service must be registered with the OSGi Framework under the interface name `org.osgi.service.wireadmin.Consumer`. The following service properties must be set:

- `service.pid` - The value of this property, also known as the PID, defines the Persistent IDentity of a service. A Consumer service must always use the same PID value whenever it is registered. The PID value allows the Wire Admin service to consistently identify the Consumer service and create a persistent Wire object that links a Producer service to a Consumer service. See the Configuration Admin specification for the rules regarding PIDs.
- `wireadmin.consumer.flavors` - The value of this property is an array of Class objects (`Class[]`) that are the acceptable classes of the objects the service can process. See *Flavors* on page 214 for more information about the data type negotiation between Producer and Consumer services.
- `wireadmin.consumer.scope` - Only for a composite Consumer service, a list of scope names that define the scope of this Consumer service, as explained in *Scope* on page 209.
- `wireadmin.consumer.composite` - List the composite identities of Producer services that this Consumer service can interoperate with. This property is of type `String[]`. A composite Consumer service can interoperate with a composite Producer service when at least one name occurs in both the Consumer service's array and the Producer service's array for this property.

### 108.3.2 Connections

When a Consumer service is registered and a Wire object exists that associates it to a registered Producer service, the `producersConnected(Wire[])` method is called on the Consumer service.

Every change in the Wire Admin service that affects a Wire object to which a Consumer service is connected must result in a call to the `producersConnected(Wire[])` method. This rule ensures that the Consumer object is informed of its role in the wiring topology. If the Consumer service has no Wire objects attached, the argument to the `producersConnected(Wire[])` method must be null. This method must also be called when a Producer service registers for the first time and no Wire objects are available.

### 108.3.3 Consumer Example

For example, a service can implement a Consumer service that logs all objects that are sent to it in order to allow debugging of a wiring topology.

```
public class LogConsumer implements Consumer{
    public LogConsumer( BundleContext context ) {
        Hashtable ht = new Hashtable();
        ht.put(
            Constants.SERVICE_PID, "com.acme.logconsumer" );
        ht.put( WireConstants.WIREADMIN_CONSUMER_FLAVORS,
            new Class[] { Object.class } );
        context.registerService( Consumer.class.getName(),
            this, ht );
    }
    public void updated( Wire wire, Object o ) {
        getLog().log( LogService.LOG_INFO, o.toString() );
    }
    public void producersConnected( Wire [] wires) {}
    LogService getLog() { ... }
}
```

### 108.3.4 Polling or Receiving a Value

When the Producer service produces a new value, it calls the `update(Object)` method on the Wire object, which in turn calls the `updated(Wire, Object)` method on the Consumer service object. When the Consumer service needs a value immediately, it can call the `poll()` method on the Wire object which in turn calls the `polled(Wire)` method on the Producer service.

If the `poll()` method on the Wire object is called and the Producer is unregistered, it must return a null value.

### 108.3.5 Consumers and Flavors

Producer objects send objects of different data types through Wire objects. A Consumer service object should offer a list of preferred data types (classes) in its service registration properties. The Producer service, however, can still send a null object or an object that is not of the preferred types. Therefore, the Consumer service must check the data type and take the appropriate action. If an object type is incompatible, then a log message should be logged to allow the operator to correct the situation.

The following example illustrates how a Consumer service can handle objects of type Date, Measurement, and String.

```
void process( Object in ) {
    if ( in instanceof Date )
        processDate( (Date) in );
    else if ( in instanceof Measurement )
        processMeasurement( (Measurement) in );
    else if ( in instanceof String )
        processString( (String) in );
    else
        processError( in );
}
```

## 108.4 Implementation issues

The Wire Admin service can call the `consumersConnected` or `producersConnected` methods during the registration of the Consumer or Producer service. Care should be taken in this method call so that no variables are used that are not yet set, such as the `ServiceRegistration` object that is returned from the registration. The same is true for the `updated` or `polled` callback because setting the Wire objects on the Producer service causes such a callback from the `consumersConnected` or `producersConnected` method.

A Wire Admin service must call the `producersConnected` and `consumersConnected` method asynchronously from the registrations, meaning that the Consumer or Producer service can use synchronized to restrict access to critical variables.

When the Wire Admin service is stopped, it must disconnect all connected consumers and producers by calling `producersConnected` and `consumersConnected` with a null for the `wires` parameter.

## 108.5 Wire Properties

A Wire object has a set of properties (a Dictionary object) that configure the association between a Consumer service and a Producer service. The type and usage of the keys, as well as the allowed types for the values are defined in *Configuration Properties* on page 94.

The Wire properties are explained in the following table.

Table 108.1 Standard Wire Properties

Constant	Description
WIREADMIN_PID	The value of this property is a unique Persistent IDentity as defined in chapter <i>Configuration Admin Service Specification</i> on page 87. This PID must be automatically created by the Wire Admin service for each new Wire object.
WIREADMIN_PRODUCER_PID	The value of the property is the PID of the Producer service.
WIREADMIN_CONSUMER_PID	The value of this property is the PID of the Consumer service.
WIREADMIN_FILTER	The value of this property is an OSGi filter string that is used to control the update of produced values.  This filter can contain a number of attributes as explained in <i>Wire Flow Control</i> on page 211.

The properties associated with a Wire object are not limited to the ones defined in Table 108.1. The Dictionary object can also be used for configuring *both* Consumer services and Producer services. Both services receive the Wire object and can inspect the properties and adapt their behavior accordingly.

### 108.5.1 Display Service Example

In the following example, the properties of a Wire object, which are set by the Operator or User, are used to configure a Producer service that monitors a user's email account regularly and sends a message when the user has received email. This WireMail service is illustrated as follows:

```
public class WireMail extends Thread
    implements Producer {
    Wire        wires[];
    BundleContext context;
    boolean     quit;

    public void start( BundleContext context ) {
        Hashtable ht = new Hashtable();
        ht.put( Constants.SERVICE_PID, "com.acme.wiremail" );
        ht.put( WireConstants.WIREADMIN_PRODUCER_FLAVORS,
            new Class[] { Integer.class } );
        context.registerService( this,
            Producer.class.getName(),
            ht );
    }
    public synchronized void consumersConnected(
        Wire wires[] ) {
        this.wires = wires;
    }
    public Object polled( Wire wire ) {
        Dictionary p = wire.getProperties();
        // The password should be
        // obtained from User Admin Service
        int n = getNrMails(
            p.get( "userid" ),
            p.get( "mailhost" ) );
        return new Integer( n );
    }
}
```

```

    }
    public synchronized void run() {
        while ( !quit )
            try {
                for ( int i=0; wires != null && i<wires.length;i++)
                    wires[i].update( polled( wires[i] ) );

                wait( 150000 );
            }
            catch( InterruptedException e ) { break; }
        }
        ...
    }

```

## 108.6 Composite objects

A Producer and/or Consumer service for each information item is usually the best solution. This solution is not feasible, however, when there are hundreds or thousands of information items. Each registered Consumer or Producer service carries the overhead of the registration, which may overwhelm a Framework implementation on smaller platforms.

When the size of the platform is an issue, a Producer and a Consumer service should abstract a larger number of information items. These Consumer and Producer services are called *composite*.

Figure 108.3

Composite Producer Example

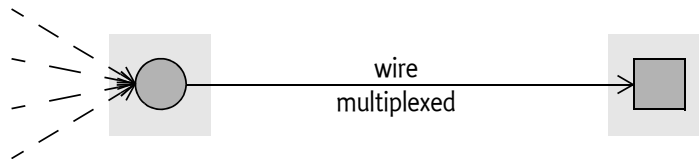

Composite Producer and Consumer services should register respectively the [WIREADMIN\\_PRODUCER\\_COMPOSITE](#) and [WIREADMIN\\_CONSUMER\\_COMPOSITE](#) *composite identity* property with their service registration. These properties should contain a list of composite identities. These identities are not defined here, but are up to a mutual agreement between the Consumer and Producer service. For example, a composite identity could be MOST-1.5 or GSM-Phase2-Terminal. The name may follow any scheme but will usually have some version information embedded. The composite identity properties are used to match Consumer and Producer services with each other during configuration of the Wire Admin service. A Consumer and Producer service should inter-operate when at least one equal composite identity is listed in both the Producer and Consumer composite identity service property.

Composite producers/consumers must identify the *kind* of objects that are transferred over the Wire object, where *kind* refers to the intent of the object, not the data type. For example, a Producer service can represent the status of a door-lock and the status of a window as a boolean. If the status of the window is transferred as a boolean to the Consumer service, how would it know that this boolean represents the window and not the door-lock

To avoid this confusion, the Wire Admin service includes an Envelope interface. The purpose of the Envelope interface is to associate a value object with:

- An identification object
- A scope name

Figure 108.4 Envelope

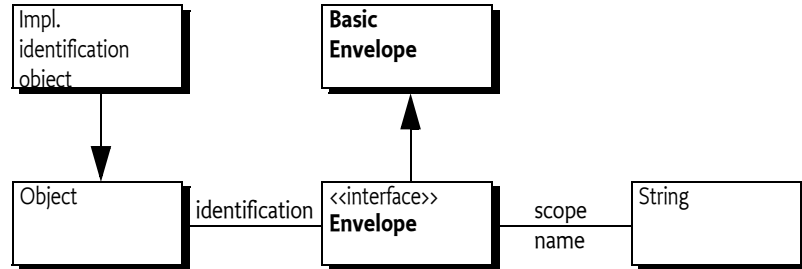

### 108.6.1 Identification

The Envelope object's identification object is used to identify the value carried in the Envelope object. Each unique kind of value must have its own unique identification object. For example, a left-front-window should have a different identification object than a rear-window.

The identification is of type Object. Using the Object class allows String objects to be used, but also makes it possible to use more complex objects. These objects can convey information in a way that is mutually agreed between the Producer and Consumer service. For example, its type may differ depending on each kind of value so that the *Visitor* pattern, see [1] *Design Patterns*, can be used. Or it may contain specific information that makes the Envelope object easier to dispatch for the Consumer service.

### 108.6.2 Scope

The scope name is a String object that *categorizes* the Envelope object. The scope name is used to limit the kind of objects that can be exchanged between composite Producer and Consumer services, depending on security settings.

The name-space for this scope should be mutually agreed between the Consumer and Producer services a priori. For the Wire Admin service, the scope name is an opaque string. Its syntax is specified in *Scope name syntax* on page 211.

Both composite Producer and Consumer services must add a list of their supported scope names to the service registration properties. This list is called the *scope* of that service. A Consumer service must add this scope property with the name of `WIREADMIN_CONSUMER_SCOPE`, a Producer service must add this scope property with the name `WIREADMIN_PRODUCER_SCOPE`. The type of this property must be a `String[]` object.

Not registering this property by the Consumer or the Producer service indicates to the Wire Admin service that any Wire object connected to that service must return null for the `Wire.getScope()` method. This case must be interpreted by the Consumer or Producer service that no scope verification is taking place. Secure Producer services should not produce values for this Wire object and secure Consumer services should not accept values.

It is also allowed to register with a *wildcard*, indicating that all scope names are supported. In that case, the `WIREADMIN_SCOPE_ALL` (which is `String[] { "*" }`) should be registered as the scope of the service. The Wire object's scope is then fully defined by the other service connected to the Wire object.

The following example shows how a scope is registered.

```

static String [] scope = { "DoorLock", "DoorOpen", "VIN" };

public void start( BundleContext context ) {
    Dictionary properties = new Hashtable();
    properties.put(
        WireConstants.WIREADMIN_CONSUMER_SCOPE,

```

```

        scope );
    properties.put( WireConstants.WIREADMIN_CONSUMER_PID,
        "com.acme.composite.consumer" );
    properties.put(
        WireConstants.WIREADMIN_CONSUMER_COMPOSITE,
        new String[] { "OSGiSP-R3" } );
    context.registerService( Consumer.class.getName(),
        new AcmeConsumer(),
        properties );
}

```

Both a composite Consumer and Producer service must register a scope to receive scope support from the Wire object. These two scopes must be converted into a single Wire object's scope and scope names in this list must be checked for the appropriate permissions. This resulting scope is available from the Wire.[getScope\(\)](#) method.

If no scope is set by either the Producer or the Consumer service the result must be null. In that case, the Producer or Consumer service must assume that no security checking is in place. A secure Consumer or Producer service should then refuse to operate with that Wire object.

Otherwise, the resulting scope is the intersection of the Consumer and Producer service scope where each name in the scope, called *m*, must be implied by a `WirePermission[m,CONSUME]` of the Consumer service, and `WirePermission[m,PRODUCE]` of the Producer service.

If either the Producer or Consumer service has registered a wildcard scope then it must not restrict the list of the other service, except for the permission check. If both the Producer and Consumer service registered a wild-card, the resulting list must be `WIREADMIN_SCOPE_ALL (String[]{"*"}).`

For example, the Consumer service has registered a scope of {A,B,C} and has `WirePermission[*,CONSUME]`. The Producer service has registered a scope of {B,C,E} and has `WirePermission[C|E, PRODUCE,]`. The resulting scope is then {C}. The following table shows this and more examples.

Table 108.2 Examples of scope calculation. C=Consumer, P=Producer, p=WirePermission, s=scope

Cs	Cp	Ps	Pp	Wire Scope
null		null		null
{A,B,C}	*	null		null
null		{C,D,E}		null
{A,B,C}	B C	{A,B,C}	A B	{B}
*	*	{A,B,C}	A B C	{A,B,C}
*	*	*	*	{*}
{A,B,C}	A B C	{A,B,C}	X	{}
{A,B,C}	*	{B,C,E}	C E	{C}

The Wire object's scope must be calculated only once, when both the Producer and Consumer service become connected. When a Producer or Consumer service subsequently modifies its scope, the Wire object must *not* modify the original scope. A Consumer and a Produce service can thus assume that the scope does not change after the `producersConnected` method or `consumersConnected` method has been called.

### 108.6.3 Access Control

When an `Envelope` object is used as argument in `Wire.update(Object)` then the Wire object must verify that the `Envelope` object's scope name is included in the Wire object's scope. If this is not the case, the update must be ignored (the updated method on the Consumer service must not be called).

A composite Producer represents a number of values, which is different from a normal Producer that can always return a single object from the poll method. A composite Producer must therefore return an array of Envelope objects (Envelope[]). This array must contain Envelope objects for all the values that are in the Wire object's scope. It is permitted to return all possible values for the Producer because the Wire object must remove all Envelope objects that have a scope name not listed in the Wire object's scope.

### 108.6.4 Composites and Flavors

Composite Producer and Consumer services must always use a flavor of the Envelope class. The data types of the values must be associated with the scope name or identification and mutually agreed between the Consumer and Producer services.

Flavors and Envelope objects both represent categories of different values. Flavors, however, are different Java classes that represent the same kind of value. For example, the tire pressure of the left front wheel could be passed as a Float, an Integer, or a Measurement object. Whatever data type is chosen, it is still the tire pressure of the left front wheel. The Envelope object represents the kind of object, for example the right front wheel tire pressure, or the left rear wheel.

### 108.6.5 Scope name syntax

Scope names are normal String objects and can, in principle, contain any Unicode character. In use, scope names can be a full wildcard (\*) but they cannot be partially wildcarded for matching scopes.

Scope names are used with the WirePermission class that extends java.security.BasicPermission. The BasicPermission class implements the implies method and performs the name matching. The wildcard matching of this class is based on the concept of names where the constituents of the name are separated with a period (.): for example, org.osgi.service.http.port.

Scope names must therefore follow the rules for fully qualified Java class names. For example, door.lock is a correct scope name while door-lock is not.

## 108.7 Wire Flow Control

The WIREADMIN\_FILTER property contains a filter expression (as defined in the OSGi Framework Filter class) that is used to limit the number of updates to the Consumer service. This is necessary because information can arrive at a much greater rate than can be processed by a Consumer service. For example, a single CAN bus (the electronic control bus used in current cars) in a car can easily deliver hundreds of measurements per second to an OSGi based controller. Most of these measurements are not relevant to the OSGi bundles, at least not all the time. For example, a bundle that maintains an indicator for the presence of frost is only interested in measurements when the outside temperature passes the 4 degrees Celsius mark.

Limiting the number of updates from a Producer service can make a significant difference in performance (meaning that less hardware is needed). For example, a vendor can implement the filter in native code and remove unnecessary updates prior to processing in the Java Virtual Machine (JVM). This is depicted in Figure 108.5 on page 212.

Figure 108.5 Filtering of Updates

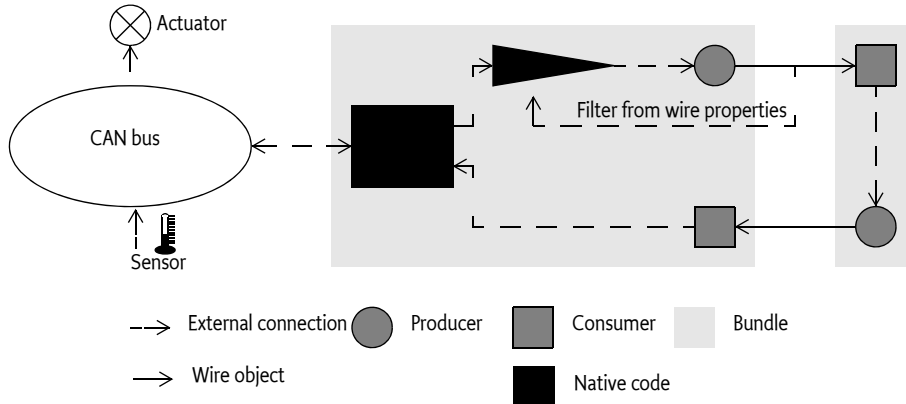

The filter can use any combination of the following attributes in a filter to implement many common filtering schemes:

Table 108.3 Filter Attribute Names

Constant	Description
WIREVALUE_CURRENT	Current value of the data from the Producer service.
WIREVALUE_PREVIOUS	Previous data value that was reported to the Consumer service.
WIREVALUE_DELTA_ABSOLUTE	The actual positive difference between the previous data value and the current data value. For example, if the previous data value was 3 and the current data value is -0.5, then the absolute delta is 3.5. This filter attribute is not set when the current or previous value is not a number.
WIREVALUE_DELTA_RELATIVE	The absolute (meaning always positive) relative change between the current and the previous data values, calculated with the following formula: $ \text{previous} - \text{current}  /  \text{current} $ . For example, if the previous value was 3 and the new value is 5, then the relative delta is $ 3 - 5  /  5  = 0.4$ . This filter attribute is not set when the current or previous value is not a number.
WIREVALUE_ELAPSED	The time in milliseconds between the last time the Consumer. <code>updated(Wire, Object)</code> returned and the time the filter is evaluated.

Filter attributes can be used to implement many common filtering schemes that limit the number of updates that are sent to a Consumer service. The Wire Admin service specification requires that updates to a Consumer service are always filtered if the `WIREADMIN_FILTER` Wire property is present. Producer services that wish to perform the filtering themselves should register with a service property `WIREADMIN_PRODUCER_FILTERS`. Filtering must be performed by the Wire object for all other Producer services.

Filtering for composite Producer services is not supported. When a filter is set on a Wire object, the Wire must still perform the filtering (which is limited to time filtering because an Envelope object is not a magnitude), but this approach may lose relevant information because the objects are of a different kind. For example, an update of every 500 ms could miss all speed updates because there is a wheel pressure update that resets the elapsed time. Producer services should, however, still implement a filtering scheme that could use proprietary attributes to filter on different kind of objects.



### 108.7.1 Filtering by Time

The simplest filter mechanism is based on time. The `wirevalue.elapsed` attribute contains the amount of milliseconds that have passed since the last update to the associated Consumer service. The following example filter expression illustrates how the updates can be limited to approximately 40 times per minute (once every 1500 ms).

```
(wirevalue.elapsed>=1500)
```

Figure 108.6 depicts this example graphically.

Figure 108.6

*Elapsed Time Change*

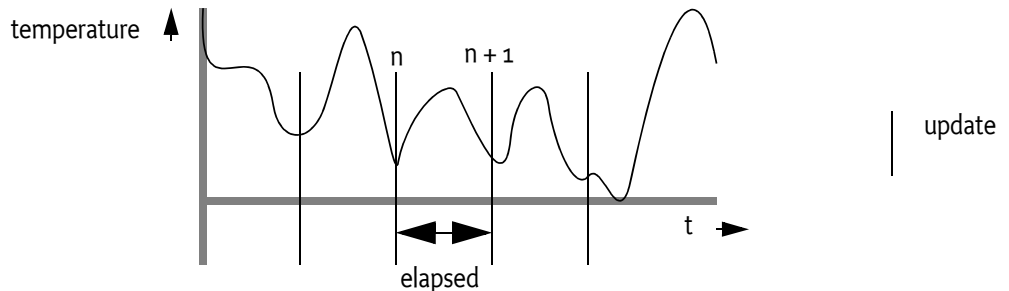

### 108.7.2 Filtering by Change

A Consumer service is often not interested in an update if the data value has not changed. The following filter expression shows how a Consumer service can limit the updates from a temperature sensor to be sent only when the temperature has changed at least 1 °K.

```
(wirevalue.delta.absolute>=1)
```

Figure 108.7 depicts a band that is created by the absolute delta between the previous data value and the current data value. The Consumer is only notified with the `updated(Wire, Object)` method when a data value is outside of this band.

Figure 108.7

*Absolute Delta*

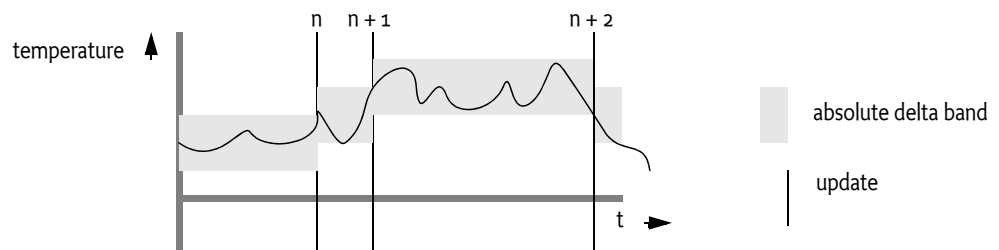

The delta may also be relative. For example, if a car is moving slowly, then updates for the speed of the car are interesting even for small variations. When a car is moving at a high rate of speed, updates are only interesting for larger variations in speed. The following example shows how the updates can be limited to data value changes of at least 10%.

```
(wirevalue.delta.relative>=0.1)
```

Figure 108.8 on page 214 depicts a relative band. Notice that the size of the band is directly proportional to the size of the sample value.

Figure 108.8

Relative Delta (not to scale)

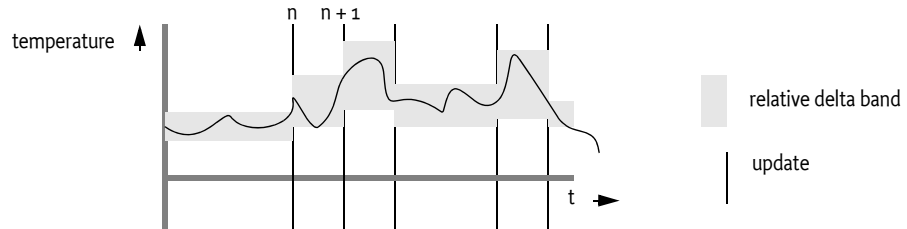

### 108.7.3

## Hysteresis

A thermostat is a control device that usually has a hysteresis, which means that a heater should be switched on below a certain specified low temperature and should be switched off at a specified high temperature, where  $high > low$ . This is graphically depicted in Figure 108.9 on page 214. The specified acceptable temperatures reduce the amount of start/stops of the heater.

Figure 108.9

Hysteresis

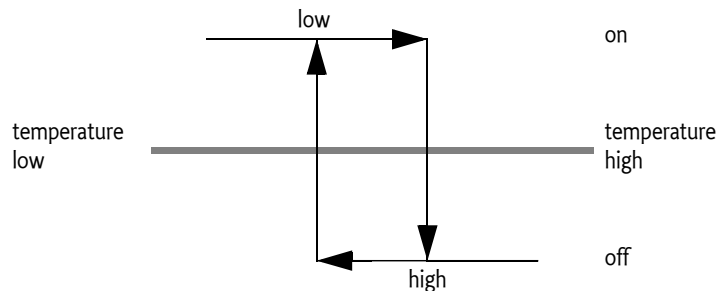

A Consumer service that controls the heater is only interested in events at the top and bottom of the hysteresis. If the specified high value is 250 °K and the specified low value is 249 °K, the following filter illustrates this concept:

```
(| (&(wirevalue.previous<=250) (wirevalue.current>250))
  (&(wirevalue.previous>=249) (wirevalue.current<249))
)
```

## 108.8

## Flavors

Both Consumer and Producer services should register with a property describing the classes of the data types they can consume or produce respectively. The classes are the *flavors* that the service supports. The purpose of flavors is to allow an administrative user interface bundle to connect Consumer and Producer services. Bundles should only create a connection when there is at least one class shared between the flavors from a Consumer service and a Producer service. Producer services are responsible for selecting the preferred object type from the list of the object types preferred by the Consumer service. If the Producer service cannot convert its data to any of the flavors listed by the Consumer service, null should be used instead.

## 108.9

## Converters

A converter is a bundle that registers a Consumer and a Producer service that are related and performs data conversions. Data values delivered to the Consumer service are processed and transferred

via the related Producer service. The Producer service sends the converted data to other Consumer services. This is shown in Figure 108.10.

Figure 108.10 Converter (for legend see Figure 108.2)

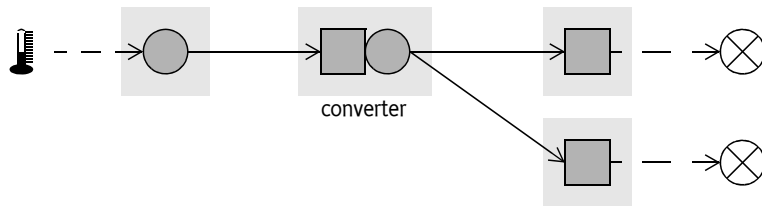

## 108.10 Wire Admin Service Implementation

The Wire Admin service is the administrative service that is used to control the wiring topology in the OSGi Framework. It contains methods to create or update wires, delete wires, and list existing wires. It is intended to be used by user interfaces or management programs that control the wiring topology of the OSGi Framework.

The `createWire(String,String,Dictionary)` method is used to associate a Producer service with a Consumer service. The method always creates and returns a new object. It is therefore possible to create multiple, distinct wires between a Producer and a Consumer service. The properties can be used to create multiple associations between Producer and Consumer services in that act in different ways.

The properties of a Wire object can be updated with the `update(Object)` method. This method must update the properties in the Wire object and must notify the associated Consumer and Producer services if they are registered. Wire objects that are no longer needed can be removed with the `deleteWire(Wire)` method. All these methods are in the `WireAdmin` class and not in the `Wire` class for security reasons. See *Security* on page 218.

The `getWires(String)` method returns an array of Wire objects (or null). All objects are returned when the filter argument is null. Specifying a filter argument limits the returned objects. The filter uses the same syntax as the Framework Filter specification. This filter is applied to the properties of the Wire object and only Wire objects that match this filter are returned.

The following example shows how the `getWires` method can be used to print the PIDs of Producer services that are wired to a specific Consumer service.

```
String f = "(wireadmin.consumer.pid=com.acme.x)";
Wire [] wires = getWireAdmin().getWires( f );
for ( int i=0; wires != null && i < wires.length; i++ )
    System.out.println(
        wires[i].getProperties().get(
            "wireadmin.producer.pid"
        )
    );
```

## 108.11 Wire Admin Listener Service Events

The Wire Admin service has an extensive list of events that it can deliver. The events allow other bundles to track changes in the topology as they happen. For example, a graphic user interface program can use the events to show when Wire objects become connected, when these objects are deleted, and when data flows over a Wire object.

A bundle that is interested in such events must register a `WireAdminListener` service object with a special Integer property `WIREADMIN_EVENTS` ("wireadmin.events"). This Integer object contains a

bitmap of all the events in which this Wire Admin Listener service is interested (events have associated constants that can be OR'd together). A Wire Admin service must not deliver events to the Wire Admin Listener service when that event type is not in the bitmap. If no such property is registered, no events are delivered to the Wire Admin Listener service.

The `WireAdminListener` interface has only one method: `wireAdminEvent(WireAdminEvent)`. The argument is a `WireAdminEvent` object that contains the event type and associated data.

A `WireAdminEvent` object can be sent asynchronously but must be ordered for each Wire Admin Listener service. The way events must be delivered is the same as described in *Delivering Events of OSGi Core Release 6*. Wire Admin Listener services must not assume that the state reflected by the event is still true when they receive the event.

The following types are defined for a `WireEvent` object:

Table 108.4

*Events*

Event type	Description
WIRE_CREATED	A new Wire object has been created.
WIRE_CONNECTED	Both the Producer service and the Consumer service are registered but may not have executed their respective <code>connectedProducers/connectedConsumers</code> methods.
WIRE_UPDATED	The Wire object's properties have been updated.
WIRE_TRACE	The Consumer has seen a new value, either after the Producer service has called the <code>Wire.update(Object)</code> method and the value was not filtered, or the Producer service has returned from the <code>Wire.polled(Wire)</code> method.
WIRE_DISCONNECTED	The Producer service or Consumer service have become unregistered and the Wire object is no longer connected.
WIRE_DELETED	The Wire object is deleted from the repository and is no longer available from the <code>getWires</code> method.
CONSUMER_EXCEPTION	The Consumer service generated an exception and the exception is included in the event.
PRODUCER_EXCEPTION	The Producer service generated an exception in a callback and the exception is included in the event.

### 108.11.1 Event Admin Service Events

Wire admin events must be sent asynchronously to the Event Admin service by the Wire Admin implementation, if present. The topic of a Wire Admin Event is one of the following:

```
org/osgi/service/wireadmin/WireAdminEvent/<eventtype>
```

The following event types are supported:

```
WIRE_CREATED
WIRE_CONNECTED
WIRE_UPDATED
WIRE_TRACE
WIRE_DISCONNECTED
WIRE_DELETED
PRODUCER_EXCEPTION
CONSUMER_EXCEPTION
```

The properties of a wire admin event are the following.

- `event` - (`WireAdminEvent`) The `WireAdminEvent` object broadcast by the Wire Admin service.

If the `getWire` method returns a non null value:

- `wire` - (`Wire`) The `Wire` object returned by the `getWire` method.
- `wire.flavors` - (`String[]`) The names of the classes returned by the `Wire` `getFlavors` method.
- `wire.scope` - (`String[]`) The scope of the `Wire` object, as returned by its `getScope` method.
- `wire.connected` - (`Boolean`) The result of the `Wire` `isConnected` method.
- `wire.valid` - (`Boolean`) The result of the `Wire` `isValid` method.

If the `getThrowable` method does not return null:

- `exception` - (`Throwable`) The `Exception` returned by the `getThrowable` method.
- `exception.class` - (`String`) The fully-qualified class name of the related `Exception`.
- `exception.message` - (`String`) The message of the related `Exception`
- `service` - (`ServiceReference`) The `Service Reference` of the `Wire Admin` service.
- `service.id` - (`Long`) The service id of the `WireAdmin` service.
- `service.objectClass` - (`String[]`) The `Wire Admin` service's object class (which must include `org.osgi.service.wireadmin.WireAdmin`)
- `service.pid` - (`String`) The `Wire Admin` service's PID.

## 108.12 Connecting External Entities

The `Wire Admin` service can be used to control the topology of consumers and producers that are services, as well as external entities. For example, a video camera controlled over an IEEE 1394B bus can be registered as a `Producer` service in the Framework's service registry and a `TV`, also connected to this bus, can be registered as a `Consumer` service. It would be very inefficient to stream the video data through the `OSGi` environment. Therefore, the `Wire Admin` service can be used to supply the external addressing information to the camera and the monitor to make a direct connection *outside* the `OSGi` environment. The `Wire Admin` service provides a uniform mechanism to connect both external entities and internal entities.

Figure 108.11 Connecting External Entities

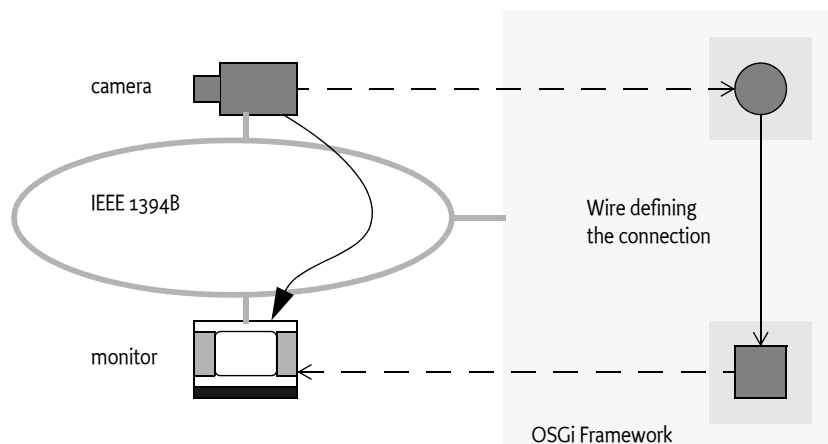

A `Consumer` service and a `Producer` service associated with a `Wire` object receive enough information to establish a direct link because the PIDs of both services are in the `Wire` object's properties. This situation, however, does not guarantee *compatibility* between `Producer` and the `Consumer` service. It is therefore recommended that flavors are used to ensure this compatibility. `Producer` services that participate in an external addressing scheme, like IEEE 1394B, should have a flavor that

reflects this address. In this case, there should then for example be a IEEE 1394B address class. Consumer services that participate in this external addressing scheme should only accept data of this flavor.

The OSGi *Device Access Specification* on page 61, defines the concept of a device category. This is a description of what classes and properties are used in a specific device category: for example, a UPnP device category that defines the interface that must be used to register for a UPnP device, among other things.

Device category descriptions should include a section that addresses the external wiring issue. This section should include what objects are send over the wire to exchange addressing information.

## 108.13 Related Standards

### 108.13.1 Java Beans

The Wire Admin service leverages the component architecture that the Framework service registry offers. Java Beans attempt to achieve similar goals. Java Beans are classes that follow a number of recommendations that allow them to be configured at run time. The techniques that are used by Java Beans during configuration are serialization and the construction of adapter classes.

Creating adapter classes in a resource constrained OSGi Framework was considered too heavy weight. Also, the dynamic nature of the OSGi environment, where services are registered and unregistered continuously, creates a mismatch between the intended target area of Java Beans and the OSGi Framework.

Also, Java Beans can freely communicate once they have a reference to each other. This freedom makes it impossible to control the communication between Java Beans.

This Wire Admin service specification was developed because it is lightweight and leverages the unique characteristics of the OSGi Framework. The concept of a Wire object that acts as an intermediate between the Producer and Consumer service allows the implementation of a security policy because both parties cannot communicate directly.

## 108.14 Security

### 108.14.1 Separation of Consumer and Producer Services

The Consumer and Producer service never directly communicate with each other. All communication takes place through a Wire object. This allows a Wire Admin service implementation to control the security aspects of creating a connection, and implies that the Wire Admin service must be a trusted service in a secure environment. Only one bundle should have the `ServicePermission[WireAdmin, REGISTER]`.

`ServicePermission[Producer|Consumer, REGISTER]` should not be restricted. `ServicePermission[Producer|Consumer,GET]` must be limited to trusted bundles (the Wire Admin service implementation) because a bundle with this permission can call such services and access information that it should not be able to access.

### 108.14.2 Using Wire Admin Service

This specification assumes that only a few applications require access to the Wire Admin service. The `WireAdmin` interface contains all the security sensitive methods that create, update, and remove Wire objects. (This is the reason that the update and delete methods are on the `WireAdmin` interface and not on the `Wire` interface). `ServicePermission[WireAdmin,GET]` should therefore only be given to trusted bundles that can manage the topology.

### 108.14.3 Wire Permission

Composite Producer and Consumer services can be restricted in their use of scope names. This restriction is managed with the `WirePermission` class. A `WirePermission` consists of a scope name and the action `CONSUME` or `PRODUCE`. The name used with the `WirePermission` may contain wild-cards as specified in the `java.security.BasicPermission` class.

## 108.15 org.osgi.service.wireadmin

Wire Admin Package Version 1.0.

Bundles wishing to use this package must list the package in the `Import-Package` header of the bundle's manifest. This package has two types of users: the consumers that use the API in this package and the providers that implement the API in this package.

Example import for consumers using the API in this package:

```
Import-Package: org.osgi.service.wireadmin; version="[1.0,2.0)"
```

Example import for providers implementing the API in this package:

```
Import-Package: org.osgi.service.wireadmin; version="[1.0,1.1)"
```

### 108.15.1 Summary

- `BasicEnvelope` - `BasicEnvelope` is an implementation of the `Envelope` interface
- `Consumer` - `Data Consumer`, a service that can receive updated values from `Producer` services.
- `Envelope` - Identifies a contained value.
- `Producer` - `Data Producer`, a service that can generate values to be used by `Consumer` services.
- `Wire` - A connection between a `Producer` service and a `Consumer` service.
- `WireAdmin` - `Wire Administration` service.
- `WireAdminEvent` - A `Wire Admin Event`.
- `WireAdminListener` - `Listener for Wire Admin Events`.
- `WireConstants` - Defines standard names for `Wire` properties, `wire filter attributes`, `Consumer` and `Producer` service properties.
- `WirePermission` - `Permission for the scope of a Wire object`.

### 108.15.2 public class BasicEnvelope implements Envelope

`BasicEnvelope` is an implementation of the `Envelope` interface

*Concurrency* Immutable

#### 108.15.2.1 public BasicEnvelope(Object value, Object identification, String scope)

*value* Content of this envelope, may be null.

*identification* Identifying object for this `Envelope` object, must not be null

*scope* Scope name for this object, must not be null

- Constructor.

*See Also* `Envelope`

#### 108.15.2.2 public Object getIdentification()

*See Also* `org.osgi.service.wireadmin.Envelope.getIdentification()`

**108.15.2.3 public String getScope()**

*See Also* org.osgi.service.wireadmin.Envelope.getScope()

**108.15.2.4 public Object getValue()**

*See Also* org.osgi.service.wireadmin.Envelope.getValue()

**108.15.3 public interface Consumer**

Data Consumer, a service that can receive updated values from Producer services.

Service objects registered under the Consumer interface are expected to consume values from a Producer service via a Wire object. A Consumer service may poll the Producer service by calling the Wire.poll() method. The Consumer service will also receive an updated value when called at its updated(Wire, Object) method. The Producer service should have coerced the value to be an instance of one of the types specified by the Wire.getFlavors() method, or one of their subclasses.

Consumer service objects must register with a service.pid and a WireConstants.WIREADMIN\_CONSUMER\_FLAVORS property. It is recommended that Consumer service objects also register with a service.description property.

If an Exception is thrown by any of the Consumer methods, a WireAdminEvent of type WireAdminEvent.CONSUMER\_EXCEPTION is broadcast by the Wire Admin service.

Security Considerations - Data consuming bundles will require ServicePermission[Consumer,REGISTER]. In general, only the Wire Admin service bundle should have this permission. Thus only the Wire Admin service may directly call a Consumer service. Care must be taken in the sharing of Wire objects with other bundles.

Consumer services must be registered with their scope when they can receive different types of objects from the Producer service. The Consumer service should have WirePermission for each of these scope names.

**108.15.3.1 public void producersConnected(Wire[] wires)**

*wires* An array of the current and complete list of Wire objects to which this Consumer service is connected. May be null if the Consumer service is not currently connected to any Wire objects.

- Update the list of Wire objects to which this Consumer service is connected.

This method is called when the Consumer service is first registered and subsequently whenever a Wire associated with this Consumer service becomes connected, is modified or becomes disconnected.

The Wire Admin service must call this method asynchronously. This implies that implementors of Consumer can be assured that the callback will not take place during registration when they execute the registration in a synchronized method.

**108.15.3.2 public void updated(Wire wire, Object value)**

*wire* The Wire object which is delivering the updated value.

*value* The updated value. The value should be an instance of one of the types specified by the Wire.getFlavors() method.

- Update the value. This Consumer service is called by the Wire object with an updated value from the Producer service.

Note: This method may be called by a Wire object prior to this object being notified that it is connected to that Wire object (via the producersConnected(Wire[]) method).

When the Consumer service can receive Envelope objects, it must have registered all scope names together with the service object, and each of those names must be permitted by the bundle's



WirePermission. If an Envelope object is delivered with the updated method, then the Consumer service should assume that the security check has been performed.

#### 108.15.4 public interface Envelope

Identifies a contained value. An Envelope object combines a status value, an identification object and a scope name. The Envelope object allows the use of standard Java types when a Producer service can produce more than one kind of object. The Envelope object allows the Consumer service to recognize the kind of object that is received. For example, a door lock could be represented by a Boolean object. If the Producer service would send such a Boolean object, then the Consumer service would not know what door the Boolean object represented. The Envelope object contains an identification object so the Consumer service can discriminate between different kinds of values. The identification object may be a simple String object, but it can also be a domain specific object that is mutually agreed by the Producer and the Consumer service. This object can then contain relevant information that makes the identification easier.

The scope name of the envelope is used for security. The Wire object must verify that any Envelope object send through the update method or coming from the poll method has a scope name that matches the permissions of both the Producer service and the Consumer service involved. The wireadmin package also contains a class BasicEnvelope that implements the methods of this interface.

*See Also* WirePermission, BasicEnvelope

##### 108.15.4.1 public Object getIdentification()

- Return the identification of this Envelope object. An identification may be of any Java type. The type must be mutually agreed between the Consumer and Producer services.

*Returns* an object which identifies the status item in the address space of the composite producer, must not be null.

##### 108.15.4.2 public String getScope()

- Return the scope name of this Envelope object. Scope names are used to restrict the communication between the Producer and Consumer services. Only Envelopes objects with a scope name that is permitted for the Producer and the Consumer services must be passed through a Wire object.

*Returns* the security scope for the status item, must not be null.

##### 108.15.4.3 public Object getValue()

- Return the value associated with this Envelope object.

*Returns* the value of the status item, or null when no item is associated with this object.

#### 108.15.5 public interface Producer

Data Producer, a service that can generate values to be used by Consumer services.

Service objects registered under the Producer interface are expected to produce values (internally generated or from external sensors). The value can be of different types. When delivering a value to a Wire object, the Producer service should coerce the value to be an instance of one of the types specified by `Wire.getFlavors()`. The classes are specified in order of preference.

When the data represented by the Producer object changes, this object should send the updated value by calling the update method on each of Wire objects passed in the most recent call to this object's `consumersConnected(Wire[])` method. These Wire objects will pass the value on to the associated Consumer service object.

The Producer service may use the information in the Wire object's properties to schedule the delivery of values to the Wire object.

Producer service objects must register with a `service.pid` and a `WireConstants.WIREADMIN_PRODUCER_FLAVORS` property. It is recommended that a Producer service object also registers with a `service.description` property. Producer service objects must register with a `WireConstants.WIREADMIN_PRODUCER_FILTERS` property if the Producer service will be performing filtering instead of the Wire object.

If an exception is thrown by a Producer object method, a `WireAdminEvent` of type `WireAdminEvent.PRODUCER_EXCEPTION` is broadcast by the Wire Admin service.

**Security Considerations.** Data producing bundles will require `ServicePermission[Producer,REGISTER]` to register a Producer service. In general, only the Wire Admin service should have `ServicePermission[Producer,GET]`. Thus only the Wire Admin service may directly call a Producer service. Care must be taken in the sharing of Wire objects with other bundles.

Producer services must be registered with scope names when they can send different types of objects (composite) to the Consumer service. The Producer service should have `WirePermission` for each of these scope names.

#### 108.15.5.1 **public void consumersConnected(Wire[] wires)**

*wires* An array of the current and complete list of Wire objects to which this Producer service is connected. May be null if the Producer is not currently connected to any Wire objects.

- Update the list of Wire objects to which this Producer object is connected.

This method is called when the Producer service is first registered and subsequently whenever a Wire associated with this Producer becomes connected, is modified or becomes disconnected.

The Wire Admin service must call this method asynchronously. This implies that implementors of a Producer service can be assured that the callback will not take place during registration when they execute the registration in a synchronized method.

#### 108.15.5.2 **public Object polled(Wire wire)**

*wire* The Wire object which is polling this service.

- Return the current value of this Producer object.

This method is called by a Wire object in response to the Consumer service calling the Wire object's `poll` method. The Producer should coerce the value to be an instance of one of the types specified by `Wire.getFlavors()`. The types are specified in order of preference. The returned value should be as new or newer than the last value furnished by this object.

**Note:** This method may be called by a Wire object prior to this object being notified that it is connected to that Wire object (via the `consumersConnected(Wire[])` method).

If the Producer service returns an `Envelope` object that has an impermissible scope name, then the Wire object must ignore (or remove) the transfer.

If the Wire object has a scope set, the return value must be an array of `Envelope` objects (`Envelope[]`). The Wire object must have removed any `Envelope` objects that have a scope name that is not in the Wire object's scope.

*Returns* The current value of the Producer service or null if the value cannot be coerced into a compatible type. Or an array of `Envelope` objects.

#### 108.15.6 **public interface Wire**

A connection between a Producer service and a Consumer service.

A Wire object connects a Producer service to a Consumer service. Both the Producer and Consumer services are identified by their unique `service.pid` values. The Producer and Consumer services may communicate with each other via Wire objects that connect them. The Producer service may send

updated values to the Consumer service by calling the `update(Object)` method. The Consumer service may request an updated value from the Producer service by calling the `poll()` method.

A Producer service and a Consumer service may be connected through multiple Wire objects.

**Security Considerations.** Wire objects are available to Producer and Consumer services connected to a given Wire object and to bundles which can access the WireAdmin service. A bundle must have `ServicePermission[WireAdmin,GET]` to get the WireAdmin service to access all Wire objects. A bundle registering a Producer service or a Consumer service must have the appropriate `ServicePermission[Consumer|Producer,REGISTER]` to register the service and will be passed Wire objects when the service object's `consumersConnected` or `producersConnected` method is called.

**Scope.** Each Wire object can have a scope set with the `setScope` method. This method should be called by a Consumer service when it assumes a Producer service that is composite (supports multiple information items). The names in the scope must be verified by the Wire object before it is used in communication. The semantics of the names depend on the Producer service and must not be interpreted by the Wire Admin service.

*No Implement* Consumers of this API must not implement this interface

#### 108.15.6.1 **public Class[] getFlavors()**

- Return the list of data types understood by the Consumer service connected to this Wire object. Note that subclasses of the classes in this list are acceptable data types as well.

The list is the value of the `WireConstants.WIREADMIN_CONSUMER_FLAVORS` service property of the Consumer service object connected to this object. If no such property was registered or the type of the property value is not `Class[]`, this method must return `null`.

*Returns* An array containing the list of classes understood by the Consumer service or `null` if the Wire is not connected, or the consumer did not register a `WireConstants.WIREADMIN_CONSUMER_FLAVORS` property or the value of the property is not of type `Class[]`.

#### 108.15.6.2 **public Object getLastValue()**

- Return the last value sent through this Wire object.

The returned value is the most recent, valid value passed to the `update(Object)` method or returned by the `poll()` method of this object. If filtering is performed by this Wire object, this methods returns the last value provided by the Producer service. This value may be an `Envelope[]` when the Producer service uses scoping. If the return value is an `Envelope` object (or array), it must be verified that the Consumer service has the proper `WirePermission` to see it.

*Returns* The last value passed though this Wire object or `null` if no valid values have been passed or the Consumer service has no permission.

#### 108.15.6.3 **public Dictionary getProperties()**

- Return the wire properties for this Wire object.

*Returns* The properties for this Wire object. The returned `Dictionary` must be read only.

#### 108.15.6.4 **public String[] getScope()**

- Return the calculated scope of this Wire object. The purpose of the Wire object's scope is to allow a Producer and/or Consumer service to produce/consume different types over a single Wire object (this was deemed necessary for efficiency reasons). Both the Consumer service and the Producer service must set an array of scope names (their scope) with the service registration property `WIREADMIN_PRODUCER_SCOPE`, or `WIREADMIN_CONSUMER_SCOPE` when they can produce multiple types. If a Producer service can produce different types, it should set this property to the array of scope names it can produce, the Consumer service must set the array of scope names it can consume. The scope of a Wire object is defined as the intersection of permitted scope names of the Producer service and Consumer service.

If neither the Consumer, or the Producer service registers scope names with its service registration, then the Wire object's scope must be null.

The Wire object's scope must not change when a Producer or Consumer services modifies its scope.

A scope name is permitted for a Producer service when the registering bundle has `WirePermission[name,PRODUCE]`, and for a Consumer service when the registering bundle has `WirePermission[name,CONSUME]`.

If either Consumer service or Producer service has not set a `WIREADMIN_*_SCOPE` property, then the returned value must be null.

If the scope is set, the Wire object must enforce the scope names when Envelope objects are used as a parameter to update or returned from the poll method. The Wire object must then remove all Envelope objects with a scope name that is not permitted.

*Returns* A list of permitted scope names or null if the Produce or Consumer service has set no scope names.

#### 108.15.6.5 **public boolean hasScope(String name)**

*name* The scope name

- Return true if the given name is in this Wire object's scope.

*Returns* true if the name is listed in the permitted scope names

#### 108.15.6.6 **public boolean isConnected()**

- Return the connection state of this Wire object.

A Wire is connected after the Wire Admin service receives notification that the Producer service and the Consumer service for this Wire object are both registered. This method will return true prior to notifying the Producer and Consumer services via calls to their respective `consumersConnected` and `producersConnected` methods.

A `WireAdminEvent` of type `WireAdminEvent.WIRE_CONNECTED` must be broadcast by the Wire Admin service when the Wire becomes connected.

A Wire object is disconnected when either the Consumer or Producer service is unregistered or the Wire object is deleted.

A `WireAdminEvent` of type `WireAdminEvent.WIRE_DISCONNECTED` must be broadcast by the Wire Admin service when the Wire becomes disconnected.

*Returns* true if both the Producer and Consumer for this Wire object are connected to the Wire object; false otherwise.

#### 108.15.6.7 **public boolean isValid()**

- Return the state of this Wire object.

A connected Wire must always be disconnected before becoming invalid.

*Returns* false if this Wire object is invalid because it has been deleted via `WireAdmin.deleteWire(Wire)`; true otherwise.

#### 108.15.6.8 **public Object poll()**

- Poll for an updated value.

This methods is normally called by the Consumer service to request an updated value from the Producer service connected to this Wire object. This Wire object will call the `Producer.poll(Wire)` method to obtain an updated value. If this Wire object is not connected, then the Producer service must not be called.

If this Wire object has a scope, then this method must return an array of Envelope objects. The objects returned must match the scope of this object. The Wire object must remove all Envelope objects

with a scope name that is not in the Wire object's scope. Thus, the list of objects returned must only contain Envelope objects with a permitted scope name. If the array becomes empty, null must be returned.

A WireAdminEvent of type WireAdminEvent.WIRE\_TRACE must be broadcast by the Wire Admin service after the Producer service has been successfully called.

*Returns* A value whose type should be one of the types returned by getFlavors(), Envelope[], or null if the Wire object is not connected, the Producer service threw an exception, or the Producer service returned a value which is not an instance of one of the types returned by getFlavors().

#### 108.15.6.9 **public void update(Object value)**

*value* The updated value. The value should be an instance of one of the types returned by getFlavors().

- Update the value.

This method is called by the Producer service to notify the Consumer service connected to this Wire object of an updated value.

If the properties of this Wire object contain a WireConstants.WIREADMIN\_FILTER property, then filtering is performed. If the Producer service connected to this Wire object was registered with the service property WireConstants.WIREADMIN\_PRODUCER\_FILTERS, the Producer service will perform the filtering according to the rules specified for the filter. Otherwise, this Wire object will perform the filtering of the value.

If no filtering is done, or the filter indicates the updated value should be delivered to the Consumer service, then this Wire object must call the Consumer.updated(Wire, Object) method with the updated value. If this Wire object is not connected, then the Consumer service must not be called and the value is ignored.

If the value is an Envelope object, and the scope name is not permitted, then the Wire object must ignore this call and not transfer the object to the Consumer service.

A WireAdminEvent of type WireAdminEvent.WIRE\_TRACE must be broadcast by the Wire Admin service after the Consumer service has been successfully called.

*See Also* WireConstants.WIREADMIN\_FILTER

### 108.15.7 **public interface WireAdmin**

Wire Administration service.

This service can be used to create Wire objects connecting a Producer service and a Consumer service. Wire objects also have wire properties that may be specified when a Wire object is created. The Producer and Consumer services may use the Wire object's properties to manage or control their interaction. The use of Wire object's properties by a Producer or Consumer services is optional.

*Security Considerations.* A bundle must have ServicePermission[WireAdmin,GET] to get the Wire Admin service to create, modify, find, and delete Wire objects.

*No Implement* Consumers of this API must not implement this interface

#### 108.15.7.1 **public Wire createWire(String producerPID, String consumerPID, Dictionary properties)**

*producerPID* The service.pid of the Producer service to be connected to the Wire object.

*consumerPID* The service.pid of the Consumer service to be connected to the Wire object.

*properties* The Wire object's properties. This argument may be null if the caller does not wish to define any Wire object's properties.

- Create a new Wire object that connects a Producer service to a Consumer service. The Producer service and Consumer service do not have to be registered when the Wire object is created.

The Wire configuration data must be persistently stored. All Wire connections are reestablished when the WireAdmin service is registered. A Wire can be permanently removed by using the `deleteWire(Wire)` method.

The Wire object's properties must have case insensitive String objects as keys (like the Framework). However, the case of the key must be preserved.

The WireAdmin service must automatically add the following Wire properties:

- `WireConstants.WIREADMIN_PID` set to the value of the Wire object's persistent identity (PID). This value is generated by the Wire Admin service when a Wire object is created.
- `WireConstants.WIREADMIN_PRODUCER_PID` set to the value of Producer service's PID.
- `WireConstants.WIREADMIN_CONSUMER_PID` set to the value of Consumer service's PID.

If the properties argument already contains any of these keys, then the supplied values are replaced with the values assigned by the Wire Admin service.

The Wire Admin service must broadcast a `WireAdminEvent` of type `WireAdminEvent.WIRE_CREATED` after the new Wire object becomes available from `getWires(String)`.

*Returns* The Wire object for this connection.

*Throws* `IllegalArgumentException`– If properties contains invalid wire types or case variants of the same key name.

#### 108.15.7.2 **public void deleteWire(Wire wire)**

*wire* The Wire object which is to be deleted.

- Delete a Wire object.

The Wire object representing a connection between a Producer service and a Consumer service must be removed. The persistently stored configuration data for the Wire object must be destroyed. The Wire object's method `Wire.isValid()` will return `false` after it is deleted.

The Wire Admin service must broadcast a `WireAdminEvent` of type `WireAdminEvent.WIRE_DELETED` after the Wire object becomes invalid.

#### 108.15.7.3 **public Wire[] getWires(String filter) throws InvalidSyntaxException**

*filter* Filter string to select Wire objects or null to select all Wire objects.

- Return the Wire objects that match the given filter.

The list of available Wire objects is matched against the specified filter. Wire objects which match the filter must be returned. These Wire objects are not necessarily connected. The Wire Admin service should not return invalid Wire objects, but it is possible that a Wire object is deleted after it was placed in the list.

The filter matches against the Wire object's properties including `WireConstants.WIREADMIN_PRODUCER_PID`, `WireConstants.WIREADMIN_CONSUMER_PID` and `WireConstants.WIREADMIN_PID`.

*Returns* An array of Wire objects which match the filter or null if no Wire objects match the filter.

*Throws* `InvalidSyntaxException`– If the specified filter has an invalid syntax.

*See Also* `org.osgi.framework.Filter`

#### 108.15.7.4 **public void updateWire(Wire wire, Dictionary properties)**

*wire* The Wire object which is to be updated.

*properties* The new Wire object's properties or null if no properties are required.

- Update the properties of a Wire object. The persistently stored configuration data for the Wire object is updated with the new properties and then the Consumer and Producer services will be called at the respective `Consumer.producersConnected(Wire[])` and `Producer.consumersConnected(Wire[])` methods.

The Wire Admin service must broadcast a `WireAdminEvent` of type `WireAdminEvent.WIRE_UPDATED` after the updated properties are available from the Wire object.

*Throws* `IllegalArgumentException`– If properties contains invalid wire types or case variants of the same key name.

### 108.15.8 **public class WireAdminEvent**

A Wire Admin Event.

`WireAdminEvent` objects are delivered to all registered `WireAdminListener` service objects which specify an interest in the `WireAdminEvent` type. Events must be delivered in chronological order with respect to each listener. For example, a `WireAdminEvent` of type `WIRE_CONNECTED` must be delivered before a `WireAdminEvent` of type `WIRE_DISCONNECTED` for a particular Wire object.

A type code is used to identify the type of event. The following event types are defined:

- `WIRE_CREATED`
- `WIRE_CONNECTED`
- `WIRE_UPDATED`
- `WIRE_TRACE`
- `WIRE_DISCONNECTED`
- `WIRE_DELETED`
- `PRODUCER_EXCEPTION`
- `CONSUMER_EXCEPTION`

Additional event types may be defined in the future.

Event type values must be unique and disjoint bit values. Event types must be defined as a bit in a 32 bit integer and can thus be bitwise OR'ed together.

Security Considerations. `WireAdminEvent` objects contain Wire objects. Care must be taken in the sharing of Wire objects with other bundles.

*See Also* `WireAdminListener`

*Concurrency* Immutable

#### 108.15.8.1 **public static final int CONSUMER\_EXCEPTION = 2**

A Consumer service method has thrown an exception.

This `WireAdminEvent` type indicates that a Consumer service method has thrown an exception. The `WireAdminEvent.getThrowable()` method will return the exception that the Consumer service method raised.

The value of `CONSUMER_EXCEPTION` is 0x00000002.

#### 108.15.8.2 **public static final int PRODUCER\_EXCEPTION = 1**

A Producer service method has thrown an exception.

This `WireAdminEvent` type indicates that a Producer service method has thrown an exception. The `WireAdminEvent.getThrowable()` method will return the exception that the Producer service method raised.

The value of `PRODUCER_EXCEPTION` is 0x00000001.

- 108.15.8.3**      **public static final int WIRE\_CONNECTED = 32**
- The WireAdminEvent type that indicates that an existing Wire object has become connected. The Consumer object and the Producer object that are associated with the Wire object have both been registered and the Wire object is connected. See Wire.isConnected() for a description of the connected state. This event may come before the producersConnected and consumersConnected method have returned or called to allow synchronous delivery of the events. Both methods can cause other WireAdminEvents to take place and requiring this event to be sent before these methods are returned would mandate asynchronous delivery.
- The value of WIRE\_CONNECTED is 0x00000020.
- 108.15.8.4**      **public static final int WIRE\_CREATED = 4**
- A Wire has been created.
- This WireAdminEvent type that indicates that a new Wire object has been created. An event is broadcast when WireAdmin.createWire(String, String, java.util.Dictionary) is called. The WireAdminEvent.getWire() method will return the Wire object that has just been created.
- The value of WIRE\_CREATED is 0x00000004.
- 108.15.8.5**      **public static final int WIRE\_DELETED = 16**
- A Wire has been deleted.
- This WireAdminEvent type that indicates that an existing wire has been deleted. An event is broadcast when WireAdmin.deleteWire(Wire) is called with a valid wire. WireAdminEvent.getWire() will return the Wire object that has just been deleted.
- The value of WIRE\_DELETED is 0x00000010.
- 108.15.8.6**      **public static final int WIRE\_DISCONNECTED = 64**
- The WireAdminEvent type that indicates that an existing Wire object has become disconnected. The Consumer object or/and Producer object is/are unregistered breaking the connection between the two. See Wire.isConnected for a description of the connected state.
- The value of WIRE\_DISCONNECTED is 0x00000040.
- 108.15.8.7**      **public static final int WIRE\_TRACE = 128**
- The WireAdminEvent type that indicates that a new value is transferred over the Wire object. This event is sent after the Consumer service has been notified by calling the Consumer.updated(Wire, Object) method or the Consumer service requested a new value with the Wire.poll() method. This is an advisory event meaning that when this event is received, another update may already have occurred and this the Wire.getLastValue() method returns a newer value then the value that was communicated for this event.
- The value of WIRE\_TRACE is 0x00000080.
- 108.15.8.8**      **public static final int WIRE\_UPDATED = 8**
- A Wire has been updated.
- This WireAdminEvent type that indicates that an existing Wire object has been updated with new properties. An event is broadcast when WireAdmin.updateWire(Wire, java.util.Dictionary) is called with a valid wire. The WireAdminEvent.getWire() method will return the Wire object that has just been updated.
- The value of WIRE\_UPDATED is 0x00000008.
- 108.15.8.9**      **public WireAdminEvent(ServiceReference reference,int type,Wire wire,Throwable exception)**
- reference* The ServiceReference object of the Wire Admin service that created this event.



*type* The event type. See `getType()`.

*wire* The Wire object associated with this event.

*exception* An exception associated with this event. This may be null if no exception is associated with this event.

- Constructs a `WireAdminEvent` object from the given `ServiceReference` object, event type, Wire object and exception.

#### **108.15.8.10      public ServiceReference getServiceReference()**

- Return the `ServiceReference` object of the Wire Admin service that created this event.

*Returns* The `ServiceReference` object for the Wire Admin service that created this event.

#### **108.15.8.11      public Throwable getThrowable()**

- Returns the exception associated with the event, if any.

*Returns* An exception or null if no exception is associated with this event.

#### **108.15.8.12      public int getType()**

- Return the type of this event.

The type values are:

- `WIRE_CREATED`
- `WIRE_CONNECTED`
- `WIRE_UPDATED`
- `WIRE_TRACE`
- `WIRE_DISCONNECTED`
- `WIRE_DELETED`
- `PRODUCER_EXCEPTION`
- `CONSUMER_EXCEPTION`

*Returns* The type of this event.

#### **108.15.8.13      public Wire getWire()**

- Return the Wire object associated with this event.

*Returns* The Wire object associated with this event or null when no Wire object is associated with the event.

### **108.15.9      public interface WireAdminListener**

Listener for Wire Admin Events.

`WireAdminListener` objects are registered with the Framework service registry and are notified with a `WireAdminEvent` object when an event is broadcast.

`WireAdminListener` objects can inspect the received `WireAdminEvent` object to determine its type, the Wire object with which it is associated, and the Wire Admin service that broadcasts the event.

`WireAdminListener` objects must be registered with a service property `WireConstants.WIREADMIN_EVENTS` whose value is a bitwise OR of all the event types the listener is interested in receiving.

For example:

```
Integer mask = new Integer(WIRE_TRACE | WIRE_CONNECTED | WIRE_DISCONNECTED);
Hashtable ht = new Hashtable();
```

```
ht.put(WIREADMIN_EVENTS, mask);
context.registerService(WireAdminListener.class.getName(), this, ht);
```

If a `WireAdminListener` object is registered without a service property `WireConstants.WIREADMIN_EVENTS`, then the `WireAdminListener` will receive no events.

Security Considerations. Bundles wishing to monitor `WireAdminEvent` objects will require `ServicePermission[WireAdminListener,REGISTER]` to register a `WireAdminListener` service. Since `WireAdminEvent` objects contain `Wire` objects, care must be taken in assigning permission to register a `WireAdminListener` service.

*See Also* `WireAdminEvent`

### 108.15.9.1 **public void wireAdminEvent(WireAdminEvent event)**

*event* The `WireAdminEvent` object.

- Receives notification of a broadcast `WireAdminEvent` object. The event object will be of an event type specified in this `WireAdminListener` service's `WireConstants.WIREADMIN_EVENTS` service property.

## 108.15.10 **public interface WireConstants**

Defines standard names for `Wire` properties, wire filter attributes, Consumer and Producer service properties.

*No Implement* Consumers of this API must not implement this interface

### 108.15.10.1 **public static final String WIREADMIN\_CONSUMER\_COMPOSITE = "wireadmin.consumer.composite"**

A service registration property for a Consumer service that is composite. It contains the names of the composite Producer services it can cooperate with. Inter-operability exists when any name in this array matches any name in the array set by the Producer service. The type of this property must be `String[]`.

### 108.15.10.2 **public static final String WIREADMIN\_CONSUMER\_FLAVORS = "wireadmin.consumer.flavors"**

Service Registration property (named `wireadmin.consumer.flavors`) specifying the list of data types understood by this Consumer service.

The Consumer service object must be registered with this service property. The list must be in the order of preference with the first type being the most preferred. The value of the property must be of type `Class[]`.

### 108.15.10.3 **public static final String WIREADMIN\_CONSUMER\_PID = "wireadmin.consumer.pid"**

Wire property key (named `wireadmin.consumer.pid`) specifying the service.pid of the associated Consumer service.

This wire property is automatically set by the Wire Admin service. The value of the property must be of type `String`.

### 108.15.10.4 **public static final String WIREADMIN\_CONSUMER\_SCOPE = "wireadmin.consumer.scope"**

Service registration property key (named `wireadmin.consumer.scope`) specifying a list of names that may be used to define the scope of this `Wire` object. A Consumer service should set this service property when it can produce more than one kind of value. This property is only used during registration, modifying the property must not have any effect of the `Wire` object's scope. Each name in the given list must have `WirePermission[name,CONSUME]` or else is ignored. The type of this service registration property must be `String[]`.

*See Also* `Wire.getScope()`, `WIREADMIN_PRODUCER_SCOPE`

**108.15.10.5**      **public static final String WIREADMIN\_EVENTS = "wireadmin.events"**

Service Registration property (named `wireadmin.events`) specifying the `WireAdminEvent` type of interest to a Wire Admin Listener service. The value of the property is a bitwise OR of all the `WireAdminEvent` types the Wire Admin Listener service wishes to receive and must be of type `Integer`.

*See Also* `WireAdminEvent`

**108.15.10.6**      **public static final String WIREADMIN\_FILTER = "wireadmin.filter"**

Wire property key (named `wireadmin.filter`) specifying a filter used to control the delivery rate of data between the Producer and the Consumer service.

This property should contain a filter as described in the `Filter` class. The filter can be used to specify when an updated value from the Producer service should be delivered to the Consumer service. In many cases the Consumer service does not need to receive the data with the same rate that the Producer service can generate data. This property can be used to control the delivery rate.

The filter can use a number of predefined attributes that can be used to control the delivery of new data values. If the filter produces a match upon the wire filter attributes, the Consumer service should be notified of the updated data value.

If the Producer service was registered with the `WIREADMIN_PRODUCER_FILTERS` service property indicating that the Producer service will perform the data filtering then the Wire object will not perform data filtering. Otherwise, the Wire object must perform basic filtering. Basic filtering includes supporting the following standard wire filter attributes:

- `WIREVALUE_CURRENT` - Current value
- `WIREVALUE_PREVIOUS` - Previous value
- `WIREVALUE_DELTA_ABSOLUTE` - Absolute delta
- `WIREVALUE_DELTA_RELATIVE` - Relative delta
- `WIREVALUE_ELAPSED` - Elapsed time

*See Also* `org.osgi.framework.Filter`

**108.15.10.7**      **public static final String WIREADMIN\_PID = "wireadmin.pid"**

Wire property key (named `wireadmin.pid`) specifying the persistent identity (PID) of this Wire object. Each Wire object has a PID to allow unique and persistent identification of a specific Wire object. The PID must be generated by the WireAdmin service when the Wire object is created.

This wire property is automatically set by the Wire Admin service. The value of the property must be of type `String`.

**108.15.10.8**      **public static final String WIREADMIN\_PRODUCER\_COMPOSITE = "wireadmin.producer.composite"**

A service registration property for a Producer service that is composite. It contains the names of the composite Consumer services it can inter-operate with. Inter-operability exists when any name in this array matches any name in the array set by the Consumer service. The type of this property must be `String[]`.

**108.15.10.9**      **public static final String WIREADMIN\_PRODUCER\_FILTERS = "wireadmin.producer.filters"**

Service Registration property (named `wireadmin.producer.filters`). A Producer service registered with this property indicates to the Wire Admin service that the Producer service implements at least the filtering as described for the `WIREADMIN_FILTER` property. If the Producer service is not registered with this property, the Wire object must perform the basic filtering as described in `WIREADMIN_FILTER`.

The type of the property value is not relevant. Only its presence is relevant.

- 108.15.10.10**      **public static final String WIREADMIN\_PRODUCER\_FLAVORS = "wireadmin.producer.flavors"**
- Service Registration property (named `wireadmin.producer.flavors`) specifying the list of data types available from this Producer service.
- The Producer service object should be registered with this service property.
- The value of the property must be of type `Class[]`.
- 108.15.10.11**      **public static final String WIREADMIN\_PRODUCER\_PID = "wireadmin.producer.pid"**
- Wire property key (named `wireadmin.producer.pid`) specifying the service.pid of the associated Producer service.
- This wire property is automatically set by the WireAdmin service. The value of the property must be of type `String`.
- 108.15.10.12**      **public static final String WIREADMIN\_PRODUCER\_SCOPE = "wireadmin.producer.scope"**
- Service registration property key (named `wireadmin.producer.scope`) specifying a list of names that may be used to define the scope of this `Wire` object. A Producer service should set this service property when it can produce more than one kind of value. This property is only used during registration, modifying the property must not have any effect of the `Wire` object's scope. Each name in the given list must have `WirePermission[name,PRODUCE]` or else is ignored. The type of this service registration property must be `String[]`.
- See Also* `Wire.getScope()`, `WIREADMIN_CONSUMER_SCOPE`
- 108.15.10.13**      **public static final String[] WIREADMIN\_SCOPE\_ALL**
- Matches all scope names.
- 108.15.10.14**      **public static final String WIREVALUE\_CURRENT = "wirevalue.current"**
- Wire object's filter attribute (named `wirevalue.current`) representing the current value.
- 108.15.10.15**      **public static final String WIREVALUE\_DELTA\_ABSOLUTE = "wirevalue.delta.absolute"**
- Wire object's filter attribute (named `wirevalue.delta.absolute`) representing the absolute delta. The absolute (always positive) difference between the last update and the current value (only when numeric). This attribute must not be used when the values are not numeric.
- 108.15.10.16**      **public static final String WIREVALUE\_DELTA\_RELATIVE = "wirevalue.delta.relative"**
- Wire object's filter attribute (named `wirevalue.delta.relative`) representing the relative delta. The relative difference is `|previous-current|/|current|` (only when numeric). This attribute must not be used when the values are not numeric.
- 108.15.10.17**      **public static final String WIREVALUE\_ELAPSED = "wirevalue.elapsed"**
- Wire object's filter attribute (named `wirevalue.elapsed`) representing the elapsed time, in ms, between this filter evaluation and the last update of the Consumer service.
- 108.15.10.18**      **public static final String WIREVALUE\_PREVIOUS = "wirevalue.previous"**
- Wire object's filter attribute (named `wirevalue.previous`) representing the previous value.
- 108.15.11**        **public final class WirePermission**  
**extends BasicPermission**
- Permission for the scope of a `Wire` object. When a `Envelope` object is used for communication with the `poll` or `update` method, and the scope is set, then the `Wire` object must verify that the Consumer service has `WirePermission[name,CONSUME]` and the Producer service has `WirePermission[name,PRODUCE]` for all names in the scope.

The names are compared with the normal rules for permission names. This means that they may end with a "\*" to indicate wildcards. E.g. Door.\* indicates all scope names starting with the string "Door". The last period is required due to the implementations of the BasicPermission class.

*Concurrency* Thread-safe

**108.15.11.1**      **public static final String CONSUME = "consume"**

The action string for the consume action.

**108.15.11.2**      **public static final String PRODUCE = "produce"**

The action string for the produce action.

**108.15.11.3**      **public WirePermission(String name,String actions)**

*name* Wire name.

*actions* produce, consume (canonical order).

- Create a new WirePermission with the given name (may be wildcard) and actions.

**108.15.11.4**      **public boolean equals(Object obj)**

*obj* The object to test for equality.

- Determines the equality of two WirePermission objects. Checks that specified object has the same name and actions as this WirePermission object.

*Returns* true if obj is a WirePermission, and has the same name and actions as this WirePermission object; false otherwise.

**108.15.11.5**      **public String getActions()**

- Returns the canonical string representation of the actions. Always returns present actions in the following order: produce, consume.

*Returns* The canonical string representation of the actions.

**108.15.11.6**      **public int hashCode()**

- Returns the hash code value for this object.

*Returns* Hash code value for this object.

**108.15.11.7**      **public boolean implies(Permission p)**

*p* The permission to check against.

- Checks if this WirePermission object implies the specified permission.

More specifically, this method returns true if:

- *p* is an instance of the WirePermission class,
- *p*'s actions are a proper subset of this object's actions, and
- *p*'s name is implied by this object's name. For example, java.\* implies java.home.

*Returns* true if the specified permission is implied by this object; false otherwise.

**108.15.11.8**      **public PermissionCollection newPermissionCollection()**

- Returns a new PermissionCollection object for storing WirePermission objects.

*Returns* A new PermissionCollection object suitable for storing WirePermission objects.

**108.15.11.9**      **public String toString()**

- Returns a string describing this `WirePermission`. The convention is to specify the class name, the permission name, and the actions in the following format: `'(org.osgi.service.wireadmin.WirePermission "name" "actions")'`.

*Returns* information about this `Permission` object.

## 108.16      References

- [1] *Design Patterns*  
Erich Gamma, Richard Helm, Ralph Johnson, and John Vlissides. Addison Wesley, ISBN 0-201-63361

# 109 IO Connector Service Specification

*Version 1.0*

## 109.1 Introduction

Communication is at the heart of OSGi Framework functionality. Therefore, a flexible and extendable communication API is needed: one that can handle all the complications that arise out of the Reference Architecture. These obstacles could include different communication protocols based on different networks, firewalls, intermittent connectivity, and others.

Therefore, this IO Connector Service specification adopts the [1] *Java 2 Micro Edition* (J2ME) `javax.microedition.io` packages as a basic communications infrastructure. In J2ME, this API is also called the Connector framework. A key aspect of this framework is that the connection is configured by a single string, the URI.

In J2ME, the Connector framework can be extended by the vendor of the Virtual Machine, but cannot be extended at run-time by other code. Therefore, this specification defines a service that adopts the flexible model of the Connector framework, but allows bundles to extend the Connector Services into different communication domains.

### 109.1.1 Essentials

- *Abstract* - Provide an intermediate layer that abstracts the actual protocol and devices from the bundle using it.
- *Extendable* - Allow third-party bundles to extend the system with new protocols and devices.
- *Layered* - Allow a protocol to be layered on top of lower layer protocols or devices.
- *Configurable* - Allow the selection of an actual protocol/device by means of configuration data.
- *Compatibility* - Be compatible with existing standards.

### 109.1.2 Entities

- *Connector Service* - The service that performs the same function, creating connections from different providers, as the static methods in the Connector framework of `javax.microedition.io`.
- *Connection Factory* - A service that extends the Connector service with more schemes.
- *Scheme* - A protocol or device that is supported in the Connector framework.

Figure 109.1 Class Diagram, org.osgi.service.io (jmi is javax.microedition.io)

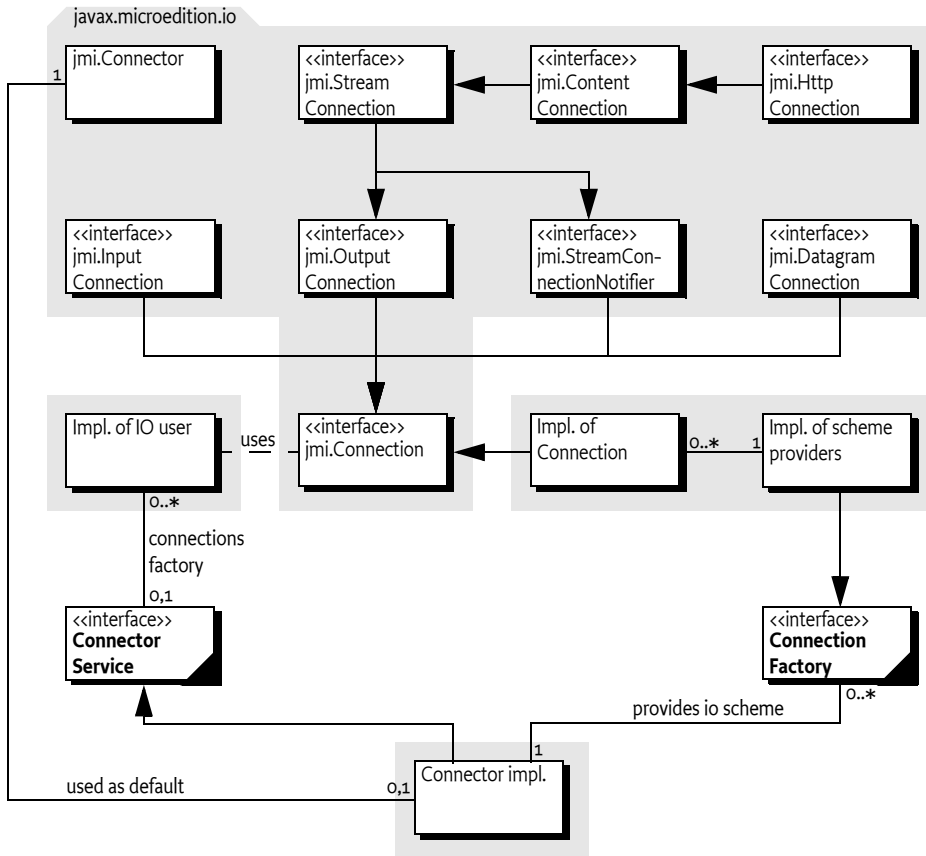

## 109.2 The Connector Framework

The [1] *Java 2 Micro Edition* specification introduces a package for communicating with back-end systems. The requirements for this package are very similar to the following OSGi requirements:

- Small footprint
- Allows many different implementations simultaneously
- Simple to use
- Simple configuration

The key design goal of the Connector framework is to allow an application to use a communication mechanism/protocol without understanding implementation details.

An application passes a Uniform Resource Identifier (URI) to the `java.microedition.io.Connector` class, and receives an object implementing one or more `Connection` interfaces. The `java.microedition.io.Connector` class uses the scheme in the URI to locate the appropriate `ConnectionFactory` service. The remainder of the URI may contain parameters that are used by the `ConnectionFactory` service to establish the connection; for example, they may contain the baud rate for a serial connection. Some examples:

- `sms://+46705950899;expiry=24h;reply=yes;type=9`
- `datagram://:53`



- `socket://www.acme.com:5302`
- `comm://COM1;baudrate=9600;databits=9`
- `file:c:/autoexec.bat`

The `javax.microedition.io` API itself does not prescribe any schemes. It is up to the implementer of this package to include a number of extensions that provide the schemes. The `javax.microedition.io.Connector` class dispatches a request to a class which provides an implementation of a `Connection` interface. J2ME does not specify how this dispatching takes place, but implementations usually offer a proprietary mechanism to connect user defined classes that can provide new schemes.

The Connector framework defines a taxonomy of communication mechanisms with a number of interfaces. For example, a `javax.microedition.io.InputConnection` interface indicates that the connection supports the input stream semantics, such as an I/O port. A `javax.microedition.io.DatagramConnection` interface indicates that communication should take place with messages.

When a `javax.microedition.io.Connector.open` method is called, it returns a `javax.microedition.io.Connection` object. The interfaces implemented by this object define the type of the communication session. The following interfaces may be implemented:

- *HttpConnection* - A `javax.microedition.io.ContentConnection` with specific HTTP support.
- *DatagramConnection* - A connection that can be used to send and receive datagrams.
- *OutputConnection* - A connection that can be used for streaming output.
- *InputConnection* - A connection that can be used for streaming input.
- *StreamConnection* - A connection that is both input and output.
- *StreamConnectionNotifier* - Can be used to wait for incoming stream connection requests.
- *ContentConnection* - A `javax.microedition.io.StreamConnection` that provides information about the type, encoding, and length of the information.

Bundles using this approach must indicate to the Operator what kind of interfaces they expect to receive. The operator must then configure the bundle with a URI that contains the scheme and appropriate options that match the bundle's expectations. Well-written bundles are flexible enough to communicate with any of the types of `javax.microedition.io.Connection` interfaces they have specified. For example, a bundle should support `javax.microedition.io.StreamConnection` as well as `javax.microedition.io.DatagramConnection` objects in the appropriate direction (input or output).

The following code example shows a bundle that sends an alarm message with the help of the `javax.microedition.io.Connector` framework:

```
public class Alarm {
    String uri;
    public Alarm(String uri) { this.uri = uri; }
    private void send(byte[] msg) {
        while ( true ) try {
            Connection connection = Connector.open( uri );
            DataOutputStream dout = null;
            if ( connection instanceof OutputConnection ) {
                dout = ((OutputConnection)
                    connection).openDataOutputStream();
                dout.write( msg );
            }
            else if ( connection instanceof DatagramConnection ) {
                DatagramConnection dgc =
                    (DatagramConnection) connection;
                Datagram datagram = dgc.newDatagram(
```

```
        msg, msg.length );
    dgc.send( datagram );
} else {
    error( "No configuration for alarm" );
    return;
}
connection.close();
} catch( Exception e ) { ... }
}
}
```

## 109.3 Connector Service

The `javax.microedition.io.Connector` framework matches the requirements for OSGi applications very well. The actual creation of connections, however, is handled through static methods in the `javax.microedition.io.Connector` class. This approach does not mesh well with the OSGi service registry and dynamic life-cycle management.

This specification therefore introduces the Connector Service. The methods of the `ConnectorService` interface have the same signatures as the static methods of the `javax.microedition.io.Connector` class.

Each `javax.microedition.io.Connection` object returned by a Connector Service must implement interfaces from the `javax.microedition.io` package. Implementations must strictly follow the semantics that are associated with these interfaces.

The Connector Service must provide all the schemes provided by the exporter of the `javax.microedition.io` package. The Connection Factory services must have priority over schemes implemented in the Java run-time environment. For example, if a Connection Factory provides the `http` scheme and a built-in implementation exists, then the Connector Service must use the Connection Factory service with the `http` scheme.

Bundles that want to use the Connector Service should first obtain a `ConnectorService` service object. This object contains open methods that should be called to get a new `javax.microedition.io.Connection` object.

## 109.4 Providing New Schemes

The Connector Service must be able to be extended with the Connection Factory service. Bundles that can provide new schemes must register a `ConnectionFactory` service object.

The Connector Service must listen for registrations of new `ConnectionFactory` service objects and make the supplied schemes available to bundles that create connections.

Implementing a Connection Factory service requires implementing the following method:

- `createConnection(String,int,boolean)` - Creates a new connection object from the given URI.

The Connection Factory service must be registered with the `IO_SCHEME` property to indicate the provided scheme to the Connector Service. The value of this property must be a `String[]`.

If multiple Connection Factory services register with the same scheme, the Connector Service should select the Connection Factory service with the highest value for the `service.ranking` service registration property, or if more than one Connection Factory service has the highest value, the Connection Factory service with the lowest `service.id` is selected.

The following example shows how a Connection Factory service may be implemented. The example will return a `javax.microedition.io.InputConnection` object that returns the value of the URI after removing the scheme identifier.

```
public class ConnectionFactoryImpl
    implements BundleActivator, ConnectionFactory {
    public void start( BundleContext context ) {
        Hashtable properties = new Hashtable();
        properties.put( IO_SCHEME, new String[]{"data"} );
        context.registerService(
            ConnectorService.class.getName(),
            this, properties );
    }
    public void stop( BundleContext context ) {}

    public Connection createConnection(
        String uri, int mode, boolean timeouts ) {
        return new DataConnection(uri);
    }
}

class DataConnection
    implements javax.microedition.io.InputConnection {
    String uri;
    DataConnection( String uri ) {this.uri = uri;}
    public DataInputStream openDataInputStream()
        throws IOException {
        return new DataInputStream( openInputStream() );
    }

    public InputStream openInputStream() throws IOException {
        byte [] buf = uri.getBytes();
        return new ByteArrayInputStream(buf, 5, buf.length-5);
    }
    public void close() {}
}
```

### 109.4.1 Orphaned Connection Objects

When a Connection Factory service is unregistered, it must close all Connection objects that are still open. Closing these Connection objects should make these objects unusable, and they should subsequently throw an `IOException` when used.

Bundles should not unnecessarily hang onto objects they retrieved from services. Implementations of Connection Factory services should program defensively and ensure that resource allocation is minimized when a Connection object is closed.

## 109.5 Execution Environment

The `javax.microedition.io` package is available in J2ME configurations/profiles, but is not present in J2SE, J2EE, and the OSGi minimum execution requirements.

Implementations of the Connector Service that are targeted for all environments should carry their own implementation of the `javax.microedition.io` package and export it.

## 109.6 Security

The OSGi Connector Service is a key service available in the Framework. A malicious bundle which provides this service can spoof any communication. Therefore, it is paramount that the `ServicePermission[ConnectorService, REGISTER]` is given only to a trusted bundle. `ServicePermission[ConnectorService, GET]` may be handed to bundles that are allowed to communicate to the external world.

`ServicePermission[ConnectionFactory, REGISTER]` should also be restricted to trusted bundles because they can implement specific protocols or access devices. `ServicePermission[ConnectionFactory, GET]` should be limited to trusted bundles that implement the Connector Service.

Implementations of Connection Factory services must perform all I/O operations within a privileged region. For example, an implementation of the `sms:` scheme must have permission to access the mobile phone, and should not require the bundle that opened the connection to have this permission. Normally, the operations need to be implemented in a `doPrivileged` method or in a separate thread.

If a specific Connection Factory service needs more detailed permissions than provided by the OSGi or Java 2, it may create a new specific Permission sub-class for its purpose.

## 109.7 org.osgi.service.io

IO Connector Package Version 1.0.

Bundles wishing to use this package must list the package in the Import-Package header of the bundle's manifest. This package has two types of users: the consumers that use the API in this package and the providers that implement the API in this package.

Example import for consumers using the API in this package:

```
Import-Package: org.osgi.service.io; version="[1.0,2.0)", javax.microedition.io
```

Example import for providers implementing the API in this package:

```
Import-Package: org.osgi.service.io; version="[1.0,1.1)", javax.microedition.io
```

### 109.7.1 Summary

- `ConnectionFactory` - A Connection Factory service is called by the implementation of the Connector Service to create `javax.microedition.io.Connection` objects which implement the scheme named by `IO_SCHEME`.
- `ConnectorService` - The Connector Service should be called to create and open `javax.microedition.io.Connection` objects.

### 109.7.2 public interface ConnectionFactory

A Connection Factory service is called by the implementation of the Connector Service to create `javax.microedition.io.Connection` objects which implement the scheme named by `IO_SCHEME`. When a `ConnectorService.open` method is called, the implementation of the Connector Service will examine the specified name for a scheme. The Connector Service will then look for a Connection Factory service which is registered with the service property `IO_SCHEME` which matches the scheme. The `createConnection(String, int, boolean)` method of the selected Connection Factory will then be called to create the actual Connection object.

**109.7.2.1**      **public static final String IO\_SCHEME = "io.scheme"**  
 Service property containing the scheme(s) for which this Connection Factory can create Connection objects. This property is of type String[].

**109.7.2.2**      **public Connection createConnection(String name,int mode,boolean timeouts) throws IOException**

*name* The full URI passed to the ConnectorService.open method

*mode* The mode parameter passed to the ConnectorService.open method

*timeouts* The timeouts parameter passed to the ConnectorService.open method

- Create a new Connection object for the specified URI.

*Returns* A new javax.microedition.io.Connection object.

*Throws* IOException– If a javax.microedition.io.Connection object cannot be created.

### 109.7.3      **public interface ConnectorService**

The Connector Service should be called to create and open javax.microedition.io.Connection objects. When an open\* method is called, the implementation of the Connector Service will examine the specified name for a scheme. The Connector Service will then look for a Connection Factory service which is registered with the service property IO\_SCHEME which matches the scheme. The createConnection method of the selected Connection Factory will then be called to create the actual Connection object.

If more than one Connection Factory service is registered for a particular scheme, the service with the highest ranking (as specified in its service.ranking property) is called. If there is a tie in ranking, the service with the lowest service ID (as specified in its service.id property), that is the service that was registered first, is called. This is the same algorithm used by BundleContext.getServiceReference.

**109.7.3.1**      **public static final int READ = 1**

Read access mode.

*See Also* javax.microedition.io.Connector.READ

**109.7.3.2**      **public static final int READ\_WRITE = 3**

Read/Write access mode.

*See Also* javax.microedition.io.Connector.READ\_WRITE

**109.7.3.3**      **public static final int WRITE = 2**

Write access mode.

*See Also* javax.microedition.io.Connector.WRITE

**109.7.3.4**      **public Connection open(String name) throws IOException**

*name* The URI for the connection.

- Create and open a Connection object for the specified name.

*Returns* A new javax.microedition.io.Connection object.

*Throws* IllegalArgumentException– If a parameter is invalid.

javax.microedition.io.ConnectionNotFoundException– If the connection cannot be found.

IOException– If some other kind of I/O error occurs.

*See Also* javax.microedition.io.Connector.open(String name)

- 109.7.3.5**            **public Connection open(String name,int mode) throws IOException**
- name*    The URI for the connection.
- mode*    The access mode.
- Create and open a Connection object for the specified name and access mode.
- Returns*    A new javax.microedition.io.Connection object.
- Throws*    IllegalArgumentException– If a parameter is invalid.  
              javax.microedition.io.ConnectionNotFoundException– If the connection cannot be found.  
              IOException– If some other kind of I/O error occurs.
- See Also*    javax.microedition.io.Connector.open(String name, int mode)
- 109.7.3.6**            **public Connection open(String name,int mode,boolean timeouts) throws IOException**
- name*    The URI for the connection.
- mode*    The access mode.
- timeouts*    A flag to indicate that the caller wants timeout exceptions.
- Create and open a Connection object for the specified name, access mode and timeouts.
- Returns*    A new javax.microedition.io.Connection object.
- Throws*    IllegalArgumentException– If a parameter is invalid.  
              javax.microedition.io.ConnectionNotFoundException– If the connection cannot be found.  
              IOException– If some other kind of I/O error occurs.
- See Also*    javax.microedition.io.Connector.open(String name, int mode, boolean timeouts)
- 109.7.3.7**            **public DataInputStream openDataInputStream(String name) throws IOException**
- name*    The URI for the connection.
- Create and open a DataInputStream object for the specified name.
- Returns*    A DataInputStream object.
- Throws*    IllegalArgumentException– If a parameter is invalid.  
              javax.microedition.io.ConnectionNotFoundException– If the connection cannot be found.  
              IOException– If some other kind of I/O error occurs.
- See Also*    javax.microedition.io.Connector.openDataInputStream(String name)
- 109.7.3.8**            **public DataOutputStream openDataOutputStream(String name) throws IOException**
- name*    The URI for the connection.
- Create and open a DataOutputStream object for the specified name.
- Returns*    A DataOutputStream object.
- Throws*    IllegalArgumentException– If a parameter is invalid.  
              javax.microedition.io.ConnectionNotFoundException– If the connection cannot be found.  
              IOException– If some other kind of I/O error occurs.
- See Also*    javax.microedition.io.Connector.openDataOutputStream(String name)
- 109.7.3.9**            **public InputStream openInputStream(String name) throws IOException**
- name*    The URI for the connection.

- Create and open an `InputStream` object for the specified name.

*Returns* An `InputStream` object.

*Throws* `IllegalArgumentException`– If a parameter is invalid.

`javax.microedition.io.ConnectionNotFoundException`– If the connection cannot be found.

`IOException`– If some other kind of I/O error occurs.

*See Also* `javax.microedition.io.Connector.openInputStream(String name)`

### 109.7.3.10 **public `OutputStream` openOutputStream(String name) throws IOException**

*name* The URI for the connection.

- Create and open an `OutputStream` object for the specified name.

*Returns* An `OutputStream` object.

*Throws* `IllegalArgumentException`– If a parameter is invalid.

`javax.microedition.io.ConnectionNotFoundException`– If the connection cannot be found.

`IOException`– If some other kind of I/O error occurs.

*See Also* `javax.microedition.io.Connector.openOutputStream(String name)`

## 109.8 References

- [1] *Java 2 Micro Edition*  
<http://www.oracle.com/technetwork/java/javame/index.html>
- [2] *J2ME Foundation Profile*  
<http://www.jcp.org/en/jsr/detailid=46>





# 110 Initial Provisioning Specification

## Version 1.2

### 110.1 Introduction

To allow freedom regarding the choice of management protocol, the OSGi Specifications assumes an architecture to remotely manage a OSGi framework with a Management Agent. The Management Agent is implemented with a Management Bundle that can communicate with an unspecified management protocol.

This specification defines how the Management Agent can make its way to the OSGi framework, and gives a structured view of the problems and their corresponding resolution methods.

The purpose of this specification is to enable the management of a OSGi framework by an Operator, and (optionally) to hand over the management of the OSGi framework later to another Operator. This approach is in accordance with the OSGi remote management reference architecture.

This bootstrapping process requires the installation of a Management Agent, with appropriate configuration data, in the OSGi framework.

This specification consists of a prologue, in which the principles of the Initial Provisioning are outlined, and a number of mappings to different mechanisms.

#### 110.1.1 Essentials

- *Policy Free* - The proposed solution must be business model agnostic; none of the affected parties (Operators, SPS Manufacturers, etc.) should be forced into any particular business model.
- *Inter-operability* - The Initial Provisioning must permit arbitrary inter-operability between management systems and OSGi frameworks. Any compliant Remote Manager should be able to manage any compliant OSGi framework, even in the absence of a prior business relationship. Adhering to this requirement allows a particular Operator to manage a variety of makes and models of OSGi framework Servers using a single management system of the Operator's choice. This rule also gives the consumer the greatest choice when selecting an Operator.
- *Flexible* - The management process should be as open as possible, to allow innovation and specialization while still achieving interoperability.

#### 110.1.2 Entities

- *Provisioning Service* - A service registered with the Framework that provides information about the initial provisioning to the Management Agent.
- *Provisioning Dictionary* - A Dictionary object that is filled with information from the ZIP files that are loaded during initial setup.
- *RSH Protocol* - An OSGi specific secure protocol based on HTTP.
- *Management Agent* - A bundle that is responsible for managing a OSGi framework under control of a Remote Manager.

Figure 110.1 Initial Provisioning

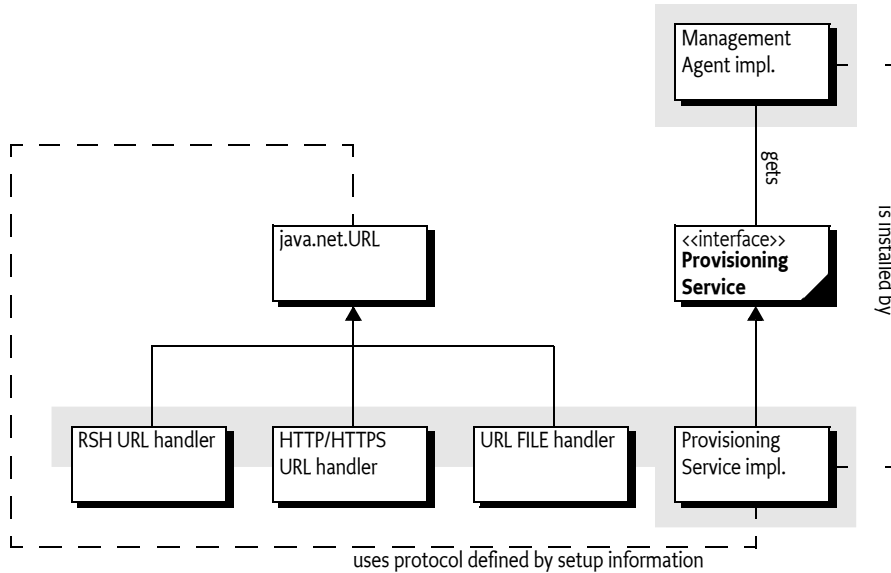

## 110.2 Procedure

The following procedure should be executed by an OSGi Framework implementation that supports this Initial Provisioning specification.

When the OSGi framework is first brought under management control, it must be provided with an initial request URL in order to be provisioned. Either the end user or the manufacturer may provide the initial request URL. How the initial request URL is transferred to the Framework is not specified, but a mechanism might, for example, be a command line parameter when the framework is started.

When asked to start the Initial Provisioning, the OSGi framework will send a request to the management system. This request is encoded in a URL, for example:

```
http://osgi.acme.com/remote-manager
```

This URL may use any protocol that is available on the OSGi framework Server. Many standard protocols exist, but it is also possible to use a proprietary protocol. For example, software could be present which can communicate with a smart card and could handle, for example, this URL:

```
smart-card://com1:0/7F20/6F38
```

Before the request URL is executed, the OSGi framework information is appended to the URL. This information includes at least the OSGi framework Identifier, but may also contain proprietary information, as long as the keys for this information do not conflict. Different URL schemes may use different methods of appending parameters; these details are specified in the mappings of this specification to concrete protocols.

The result of the request must be a ZIP file. (The content type should be application/zip). It is the responsibility of the underlying protocol to guarantee the integrity and authenticity of this ZIP file.

This ZIP file is unpacked and its entries (except bundle and bundle-url entries, described in Table 110.2) are placed in a Dictionary object. This Dictionary object is called the *Provisioning Dictionary*. It must be made available from the Provisioning Service in the service registry. The names of the entries in the ZIP file must not start with a solidus ('/' \u002F).

The ZIP file may contain only four types of dictionary entries: text, binary, bundle, or bundle-url. The type of an entry can be specified in different ways. An Initial Provisioning service must look in the following places to find the information about an entry's (MIME) type (in the given order):

1. The manifest header `InitialProvisioning-Entries` of the given ZIP file. This header is defined in *InitialProvisioning-Entries Manifest Header* on page 249. If this header is present, but a given entry's path is not named then try the next step.
2. The extension of the entry path name if one of `.txt`, `.jar`, `.url` extensions. See Table 110.1 on page 247 for the mapping of types, MIME types, and extensions.
3. The entry is assumed to be a binary type

The types can optionally be specified as a MIME type as defined in [7] *MIME Types*. The text and bundle-url entries are translated into a String object from an UTF-8 encoded byte array. All other entries must be stored as a byte[].

Table 110.1 Content types of provisioning ZIP file

Type	MIME Type	Ext	Description
text	<code>MIME_STRING</code> text/plain;charset=utf-8	.txt	Must be represented as a String object
binary	<code>MIME_BYTE_ARRAY</code> application/octet-stream	not txt, .url, or .jar	Must be represented as a byte array (byte[]).
bundle	<code>MIME_BUNDLE</code> application/vnd.osgi.bundle <code>MIME_BUNDLE_ALT</code> application/x-osgi-bundle	.jar	<p>Entries must be installed using <code>BundleContext.installBundle(String, InputStream)</code>, with the <code>InputStream</code> object constructed from the contents of the ZIP entry. The location must be the name of the ZIP entry without leading solidus ('' \u002F). This entry must not be stored in the Provisioning Dictionary.</p> <p>If a bundle with this location name is already installed in this system, then this bundle must be updated instead of installed.</p> <p>The <code>MIME_BUNDLE_ALT</code> version is intended for backward compatibility, it specifies the original MIME type for bundles before there was an official IANA MIME type.</p>
bundle-url	<code>MIME_BUNDLE_URL</code> text/x-osgi-bundle-url; charset=utf-8	.url	<p>The content of this entry is a string coded in utf-8. Entries must be installed using <code>BundleContext.installBundle(String, InputStream)</code>, with the <code>InputStream</code> object created from the given URL. The location must be the name of the ZIP entry without leading solidus ('' \u002F). This entry must not be stored in the Provisioning Dictionary.</p> <p>If a bundle with this location URL is already installed in this system, then this bundle must be updated instead of installed.</p>

The Provisioning Service must install (but not start) all entries in the ZIP file that are typed with bundle or bundle-url.

If an entry named `PROVISIONING_START_BUNDLE` is present in the Provisioning Dictionary, then its content type must be text as defined in Table 110.1. The content of this entry must match the bundle location of a previously loaded bundle. This designated bundle must be given `AllPermission` and started.

If no `PROVISIONING_START_BUNDLE` entry is present in the Provisioning Dictionary, the Provisioning Dictionary should contain a reference to another ZIP file under the `PROVISIONING_REFERENCE` key. If both keys are absent, no further action must take place.

If this `PROVISIONING_REFERENCE` key is present and holds a String object that can be mapped to a valid URL, then a new ZIP file must be retrieved from this URL. The `PROVISIONING_REFERENCE` link may be repeated multiple times in successively loaded ZIP files.

Referring to a new ZIP file with such a URL allows a manufacturer to place a fixed reference inside the OSGi framework Server (in a file or smart card) that will provide some platform identifying information and then also immediately load the information from the management system. The `PROVISIONING_REFERENCE` link may be repeated multiple times in successively loaded ZIP files. The entry `PROVISIONING_UPDATE_COUNT` must be an Integer object that must be incremented on every iteration.

Information retrieved while loading subsequent `PROVISIONING_REFERENCE` URLs may replace previous key/values in the Provisioning Dictionary, but must not erase unrecognized key/values. For example, if an assignment has assigned the key `proprietary-x`, with a value '3', then later assignments must not override this value, unless the later loaded ZIP file contains an entry with that name. All these updates to the Provisioning Dictionary must be stored persistently. At the same time, each entry of type `bundle` or `bundle-url` (see Table 110.1 ) must be installed and not started.

Once the Management Agent has been started, the Initial Provisioning service has become operational. In this state, the Initial Provisioning service must react when the Provisioning Dictionary is updated with a new `PROVISIONING_REFERENCE` property. If this key is set, it should start the cycle again. For example, if the control of a OSGi framework needs to be transferred to another Remote Manager, the Management Agent should set the `PROVISIONING_REFERENCE` to the location of this new Remote Manager's Initial Provisioning ZIP file. This process is called *re-provisioning*.

If errors occur during this process, the Initial Provisioning service should try to notify the Service User of the problem.

The previous description is depicted in Figure 110.2 as a flow chart.

Figure 110.2 Flow chart installation Management Agent bundle

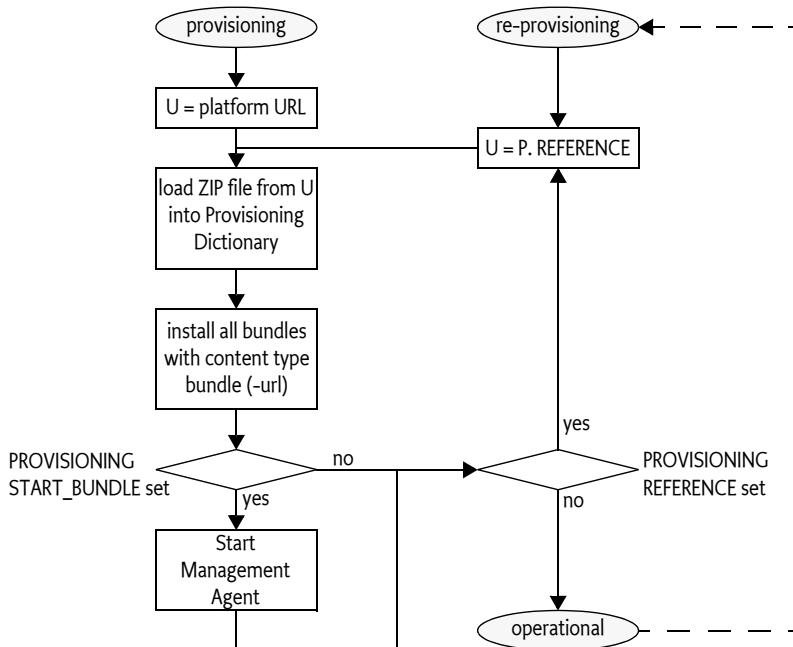

The Management Agent may require configuration data that is specific to the OSGi framework instance. If this data is available outside the Management Agent bundle, the merging of this data with the Management Agent may take place in the OSGi framework. Transferring the data separately will make it possible to simplify the implementation on the server side, as it is not necessary to create *personalized* OSGi framework bundles. The `PROVISIONING_AGENT_CONFIG` key is reserved for this purpose, but the Management Agent may use another key or mechanisms if so desired.

The `PROVISIONING_SPID` key must contain the OSGi framework Identifier.

### 110.2.1 InitialProvisioning-Entries Manifest Header

The InitialProvisioning-Entries manifest header optionally specifies the type of the entries in the ZIP file. The syntax for this header is:

```
InitialProvisioning-Entries ::= ip-entry ( ',' ip-entry ) *
ip-entry ::= path ( ';' parameter ) *
```

The entry is the path name of a resource in the ZIP file. This InitialProvisioning-Entries header recognizes the following attribute:

- `type` - Gives the type of the dictionary entry. The type can have one of the following values: `text`, `binary`, `bundle`, or `bundle-url`

If the `type` parameter entry is not specified for an entry, then the type will be inferred from the extension of the entry, as defined in table Table 110.1 on page 247.

## 110.3 Special Configurations

The next section shows some examples of specially configured types of OSGi framework Servers and how they are treated with the respect to the specifications in this document.

### 110.3.1 Branded OSGi framework Server

If a OSGi framework Operator is selling OSGi framework Servers branded exclusively for use with their service, the provisioning will most likely be performed prior to shipping the OSGi framework Server to the User. Typically the OSGi framework is configured with the Dictionary entry [PROVISIONING\\_REFERENCE](#) pointing at a location controlled by the Operator.

Up-to-date bundles and additional configuration data must be loaded from that location at activation time. The OSGi framework is probably equipped with necessary security entities, like certificates, to enable secure downloads from the Operator's URL over open networks, if necessary.

### 110.3.2 Non-connected OSGi framework

Circumstances might exist in which the OSGi framework Server has no WAN connectivity, or prefers not to depend on it for the purposes not covered by this specification.

The non-connected case can be implemented by specifying a file:// URL for the initial ZIP file ( [PROVISIONING\\_REFERENCE](#) ). That file:// URL would name a local file containing the response that would otherwise be received from a remote server.

The value for the Management Agent [PROVISIONING\\_REFERENCE](#) found in that file will be used as input to the load process. The [PROVISIONING\\_REFERENCE](#) may point to a bundle file stored either locally or remotely. No code changes are necessary for the non-connected scenario. The file:// URLs must be specified, and the appropriate files must be created on the OSGi framework.

## 110.4 The Provisioning Service

Provisioning information is conveyed between bundles using the Provisioning Service, as defined in the [ProvisioningService](#) interface. The Provisioning Dictionary is retrieved from the [ProvisioningService](#) object using the [getInformation\(\)](#) method. This is a read-only Dictionary object, any changes to this Dictionary object must throw an [UnsupportedOperationException](#).

The Provisioning Service provides a number of methods to update the Provisioning Dictionary.

- [addInformation\(Dictionary\)](#) - Add all key/value pairs in the given Dictionary object to the Provisioning Dictionary.
- [addInformation\(InputStream\)](#) - It is also possible to add a ZIP file to the Provisioning Service immediately. This will unpack the ZIP file and add the entries to the Provisioning Dictionary. This method must install the bundles contained in the ZIP file as described in *Procedure* on page 246.
- [setInformation\(Dictionary\)](#) - Set a new Provisioning Dictionary. This will remove all existing entries.

Each of these method will increment the [PROVISIONING\\_UPDATE\\_COUNT](#) entry.

## 110.5 Management Agent Environment

The Management Agent should be written with great care to minimize dependencies on other packages and services, as *all* services in OSGi are optional. Some OSGi frameworks may have other bundles pre-installed, so it is possible that there may be exported packages and services available. Mechanisms outside the current specification, however, must be used to discover these packages and services before the Management Agent is installed.

The Provisioning Service must ensure that the Management Agent is running with [AllPermission](#). The Management Agent should check to see if the [Permission Admin](#) service is available, and establish the initial permissions as soon as possible to insure the security of the device when later

bundles are installed. As the PermissionAdmin interfaces may not be present (it is an optional service), the Management Agent should export the PermissionAdmin interfaces to ensure they can be resolved.

Once started, the Management Agent may retrieve its configuration data from the Provisioning Service by getting the byte[] object that corresponds to the `PROVISIONING_AGENT_CONFIG` key in the Provisioning Dictionary. The structure of the configuration data is implementation specific.

The scope of this specification is to provide a mechanism to transmit the raw configuration data to the Management Agent. The Management Agent bundle may alternatively be packaged with its configuration data in the bundle, so it may not be necessary for the Management Agent bundle to use the Provisioning Service at all.

Most likely, the Management Agent bundle will install other bundles to provision the OSGi framework. Installing other bundles might even involve downloading a more full featured Management Agent to replace the initial Management Agent.

## 110.6 Mapping To File Scheme

The file: scheme is the simplest and most completely supported scheme which can be used by the Initial Provisioning specification. It can be used to store the configuration data and Management Agent bundle on the OSGi framework Server, and avoids any outside communication.

If the initial request URL has a file scheme, no parameters should be appended, because the file: scheme does not accept parameters.

### 110.6.1 Example With File Scheme

The manufacturer should prepare a ZIP file containing only one entry named `PROVISIONING_START_BUNDLE` that contains a location string of an entry of type bundle or bundle-url. For example, the following ZIP file demonstrates this:

```
provisioning.start.bundle  text      agent
agent                      bundle   COAF0E9B2AB..
```

The bundle may also be specified with a URL:

```
provisioning.start.bundle  text      http://acme.com/a.jar
agent                      bundle-url http://acme.com/a.jar
```

Upon startup, the framework is provided with the URL with the file: scheme that points to this ZIP file:

```
file:/opt/osgi/ma.zip
```

## 110.7 Mapping To HTTP(S) Scheme

This section defines how HTTP and HTTPS URLs must be used with the Initial Provisioning specification.

- HTTP - May be used when the data exchange takes place over networks that are secured by other means, such as a Virtual Private Network (VPN) or a physically isolated network. Otherwise, HTTP is not a valid scheme because no authentication takes place.
- HTTPS - May be used if the OSGi framework is equipped with appropriate certificates.

HTTP and HTTPS share the following qualities:

- Both are well known and widely used
- Numerous implementations of the protocols exist
- Caching of the Management Agent will be desired in many implementations where limited bandwidth is an issue. Both HTTP and HTTPS already contain an accepted protocol for caching.

Both HTTP and HTTPS must be used with the GET method. The response is a ZIP file, implying that the response header Content-Type header must contain application/zip.

### 110.7.1 HTTPS Certificates

In order to use HTTPS, certificates must be in place. These certificates, that are used to establish trust towards the Operator, may be made available to the OSGi framework using the Provisioning Service. The root certificate should be assigned to the Provisioning Dictionary before the HTTPS provider is used. Additionally, the OSGi framework should be equipped with a OSGi framework certificate that allows the OSGi framework to properly authenticate itself towards the Operator. This specification does not state how this certificate gets installed into the OSGi framework.

The root certificate is stored in the Provisioning Dictionary under the key:

`PROVISIONING_ROOTX509`

The Root X.509 Certificate holds certificates used to represent a handle to a common base for establishing trust. The certificates are typically used when authenticating a Remote Manager to the OSGi framework. In this case, a Root X.509 certificate must be part of a certificate chain for the Operator's certificate. The format of the certificate is defined in *Certificate Encoding* on page 252.

### 110.7.2 Certificate Encoding

Root certificates are X.509 certificates. Each individual certificate is stored as a byte[] object. This byte[] object is encoded in the default Java manner, as follows:

- The original, binary certificate data is DER encoded
- The DER encoded data is encoded into base64 to make it text.
- The base64 encoded data is prefixed with

```
-----BEGIN CERTIFICATE-----
```

and suffixed with:

```
-----END CERTIFICATE-----
```

- If a record contains more than one certificate, they are simply appended one after the other, each with a delimiting prefix and suffix.

The decoding of such a certificate may be done with the `java.security.cert.CertificateFactory` class:

```
InputStream bis = new ByteArrayInputStream(x509); // byte []
CertificateFactory cf =
    CertificateFactory.getInstance("X.509");
Collection c = cf.generateCertificates(bis);
Iterator i = c.iterator();
while (i.hasNext()) {
    Certificate cert = (Certificate)i.next();
    System.out.println(cert);
}
```



### 110.7.3 URL Encoding

The URL must contain the OSGi framework Identity, and may contain more parameters. These parameters are encoded in the URL according to the HTTP(S) URL scheme. A base URL may be set by an end user but the Provisioning Service must add the OSGi framework Identifier.

If the request URL already contains HTTP parameters (if there is a '?' in the request), the `service_platform_id` is appended to this URL as an additional parameter. If, on the other hand, the request URL does not contain any HTTP parameters, the `service_platform_id` will be appended to the URL after a '?', becoming the first HTTP parameter. The following two examples show these two variants:

```
http://server.operator.com/service-x? «
    foo=bar&service_platform_id=VIN:123456789
```

```
http://server.operator.com/service-x? «
    service_platform_id=VIN:123456789
```

Proper URL encoding must be applied when the URL contains characters that are not allowed. See [6] *RFC 2396 - Uniform Resource Identifier (URI)*.

## 110.8 Mapping To RSH Scheme

The RSH protocol is an OSGi-specific protocol, and is included in this specification because it is optimized for Initial Provisioning. It requires a shared secret between the management system and the OSGi framework that is small enough to be entered by the Service User.

RSH bases authentication and encryption on Message Authentication Codes (MACs) that have been derived from a secret that is shared between the OSGi framework and the Operator prior to the start of the protocol execution.

The protocol is based on an ordinary HTTP GET request/response, in which the request must be *signed* and the response must be *encrypted* and *authenticated*. Both the *signature* and *encryption key* are derived from the shared secret using Hashed Message Access Codes (HMAC) functions.

As additional input to the HMAC calculations, one client-generated nonce and one server-generated nonce are used to prevent replay attacks. The nonces are fairly large random numbers that must be generated in relation to each invocation of the protocol, in order to guarantee freshness. These nonces are called `clientfg` (client-generated freshness guarantee) and `serverfg` (server-generated freshness guarantee).

In order to separate the HMAC calculations for authentication and encryption, each is based on a different constant value. These constants are called the *authentication constant* and the *encryption constant*.

From an abstract perspective, the protocol may be described as follows.

- $\delta$  - Shared secret, 160 bits or more
- $s$  - Server nonce, called `servercfg`, 128 bits
- $c$  - Client nonce, called `clientfg`, 128 bits
- $K_a$  - Authentication key, 160 bits
- $K_e$  - Encryption key, 192 bits
- $r$  - Response data
- $e$  - Encrypted data
- $E$  - Encryption constant, a byte[] of 05, 36, 54, 70, 00 (hex)
- $A$  - Authentication constant, a byte[] of 00, 4f, 53, 47, 49 (hex)

- $M$  - Message material, used for  $K_e$  calculation.
- $m$  - The calculated message authentication code.
- $3DES$  - Triple DES, encryption function, see [8] *3DES*. The bytes of the key must be set to odd parity. CBC mode must be used where the padding method is defined in [9] *RFC 1423 Part III: Algorithms, Modes, and Identifiers*. In [11] *Java Cryptography API (part of Java 1.4)* this is addressed as `PKCS5Padding`.
- $IV$  - Initialization vector for 3DES.
- $SHA1$  - Secure Hash Algorithm to generate the Hashed Message Authentication Code, see [12] *SHA-1*. The function takes a single parameter, the block to be worked upon.
- $HMAC$  - The function that calculates a message authentication code, which must be  $HMAC-SHA1$ .  $HMAC-SHA1$  is defined in [1] *HMAC: Keyed-Hashing for Message Authentication*. The  $HMAC$  function takes a key and a block to be worked upon as arguments. Note that the lower 16 bytes of the result must be used.
- $\{\}$  - Concatenates its arguments
- $[ ]$  - Indicates access to a sub-part of a variable, in bytes. Index starts at one, not zero.

In each step, the emphasized server or client indicates the context of the calculation. If both are used at the same time, each variable will have server or client as a subscript.

1. The *client* generates a random nonce, stores it and denotes it `clientfg`

$$c = \text{nonce}$$

2. The client sends the request with the `clientfg` to the server.

$$c_{\text{server}} \leftarrow c_{\text{client}}$$

3. The *server* generates a nonce and denotes it `serverfg`.

$$s = \text{nonce}$$

4. The *server* calculates an authentication key based on the  $SHA1$  function, the shared secret, the received `clientfg`, the `serverfg` and the authentication constant.

$$K_a \leftarrow SHA1(\{\delta, c, s, A\})$$

5. The *server* calculates an encryption key using an  $SHA-1$  function, the shared secret, the received `clientfg`, the `serverfg` and the encryption constant. It must first calculate the *key material*  $M$ .

$$M[1, 20] \leftarrow SHA1(\{\delta, c, s, E\})$$

$$M[21, 40] \leftarrow SHA1(\{\delta, M[1, 20], c, s, E\})$$

6. The key for DES consists  $K_e$  and  $IV$ .

$$K_e \leftarrow M[1, 24]$$

$$IV \leftarrow M[25, 32]$$

The *server* encrypts the response data using the encryption key derived in step 5. The encryption algorithm that must be used to encrypt/decrypt the response data is 3DES. 24 bytes (192 bits) from  $M$  are used to generate  $K_e$ , but the low order bit of each byte must be used as an odd parity bit. This means that before using  $K_e$ , each byte must be processed to set the low order bit so that the byte has odd parity.

The encryption/decryption key used is specified by the following:

$$e \leftarrow 3DES(K_e, IV, r)$$

7. The *server* calculates a MAC  $m$  using the  $HMAC$  function, the encrypted response data and the authentication key derived in 4.

$$m \leftarrow HMAC(K_a, e)$$

8. The *server* sends a response to the *client* containing the `serverfg`, the MAC  $m$  and the encrypted response data

$$s_{\text{client}} \leftarrow s_{\text{server}}$$

$$m_{\text{client}} \leftarrow m_{\text{server}}$$

$$e_{\text{client}} \leftarrow e_{\text{server}}$$

The *client* calculates the encryption key  $K_e$  the same way the server did in steps 5 and 6, and uses this to decrypt the encrypted response data. The *serverfg* value received in the response is used in the calculation.

$$r \leftarrow 3DES(K_e, IV, e)$$

- The *client* performs the calculation of the MAC  $m'$  in the same way the server did, and checks that the results match the received MAC  $m$ . If they do not match, further processing is discarded. The *serverfg* value received in the response is used in the calculation.

$$K_a \leftarrow \text{SHAI}(\{\delta, c, s, A\})$$

$$m' \leftarrow \text{HMAC}(K_a, e)$$

$$m' = m$$

Figure 110.3

Action Diagram for RSH

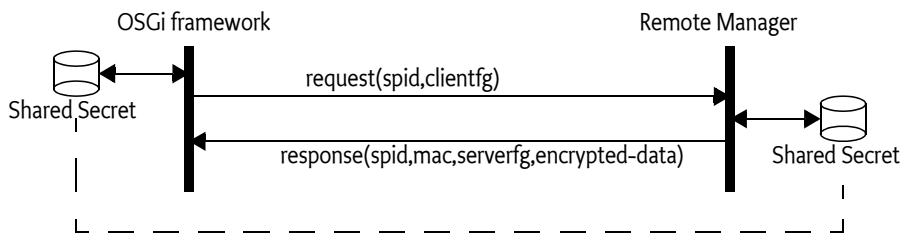

### 110.8.1

#### Shared Secret

The *shared secret* should be a key of length 160 bits (20 bytes) or more. The length is selected to match the output of the selected hash algorithm [2] NIST, *FIPS PUB 180-1: Secure Hash Standard*, April 1995..

In some scenarios, the shared secret is generated by the Operator and communicated to the User, who inserts the secret into the OSGi framework through some unspecified means.

The opposite is also possible: the shared secret can be stored within the OSGi framework, extracted from it, and then communicated to the Operator. In this scenario, the source of the shared secret could be either the OSGi framework or the Operator.

In order for the server to calculate the authentication and encryption keys, it requires the proper shared secret. The server must have access to many different shared secrets, one for each OSGi framework it is to support. To be able to resolve this issue, the server must typically also have access to the OSGi framework Identifier of the OSGi framework. The normal way for the server to know the OSGi framework Identifier is through the application protocol, as this value is part of the URL encoded parameters of the HTTP, HTTPS, or RSH mapping of the Initial Provisioning.

In order to be able to switch Operators, a new shared secret must be used. The new secret may be generated by the new Operator and then inserted into the OSGi framework device using a mechanism not covered by this specification. Or the device itself may generate the new secret and convey it to the owner of the device using a display device or read-out, which is then communicated to the new operator out-of-band. Additionally, the generation of the new secret may be triggered by some external event, like holding down a button for a specified amount of time.

### 110.8.2 Request Coding

RSH is mapped to HTTP or HTTPS. Thus, the request parameters are URL encoded as discussed in *URL Encoding* on page 253. RSH requires an additional parameter in the URL: the `clientfg` parameter. This parameter is a nonce that is used to counter replay attacks. See also *RSH Transport* on page 256.

### 110.8.3 Response Coding

The server's response to the client is composed of three parts:

- A header containing the protocol version and the `serverfg`
- The MAC
- The encrypted response

These three items are packaged into a binary container according to Table 110.2.

Table 110.2 *RSH Header description*

Bytes	Description	Value hex
4	Number of bytes in header	2E
1	Major version number	01
1	Minor version number	00
16	<code>serverfg</code>	...
4	Number of bytes in MAC	10
16	Message Authentication Code	MAC
4	Number of bytes of encrypted ZIP file	N
N	Encrypted ZIP file	...

The response content type is an RSH-specific encrypted ZIP file, implying that the response header `Content-Type` must be `application/x-rsh` for the HTTP request. When the content file is decrypted, the content must be a ZIP file.

### 110.8.4 RSH URL

The RSH URL must be used internally within the OSGi framework to indicate the usage of RSH for initial provisioning. The RSH URL format is identical to the HTTP URL format, except that the scheme is `rsh`: instead of `http`:. For example ( `<<` means line continues on next line):

```
rsh://server.operator.com/service-x
```

### 110.8.5 Extensions to the Provisioning Service Dictionary

RSH specifies one additional entry for the Provisioning Dictionary:

`PROVISIONING_RSH_SECRET`

The value of this entry is a `byte[]` containing the shared secret used by the RSH protocol.

### 110.8.6 RSH Transport

RSH is mapped to HTTP or HTTPS and follows the same URL encoding rules, except that the `clientfg` is additionally appended to the URL. The key in the URL must be `clientfg` and the value must be encoded in base 64 format:

The `clientfg` parameter is transported as an HTTP parameter that is appended after the `service_platform_id` parameter. The second example above would then be:

```
rsh://server.operator.com/service-x
```

Which, when mapped to HTTP, must become:

```
http://server.operator.com/service-x «  
service_platform_id=VIN:123456789& «  
clientfg=AHPmWcw%2FsiWYC37xZNdKvQ%3D%3D
```

## 110.9 Exception Handling

The Initial Provisioning process is a sensitive process that must run without user supervision. There is therefore a need to handle exceptional cases in a well defined way to simplify trouble shooting.

There are only 2 types of problems that halt the provisioning process. They are:

- IO Exception when reading or writing provisioning information.
- IO Exception when retrieving or processing a provisioning zip file.

Other exceptions can occur and the Provisioning Service must do any attempt to log these events.

In the cases that the provisioning process stops, it is important that the clients of the provisioning service have a way to find out that the process is stopped. The mechanism that is used for this is a special entry in the provisioning dictionary. The name of the entry must be `provisioning.error`. The value is a String object with the following format:

- Numeric error code
- Space
- A human readable string describing the error.

Permitted error codes are:

- 0 - Unknown error
- 1 - Couldn't load or save provisioning information
- 2 - Malformed URL Exception
- 3 - IO Exception when retrieving document of a URL
- 4 - Corrupted Zip Input Stream

The `provisioning.update.count` will be incremented as normal when a `provisioning.error` entry is added to the provisioning information. After, the provisioning service will take no further action.

Some examples:

```
0 SIM card removed  
2 "http://www.acme.com/secure/blib/ifa.zip"
```

## 110.10 Security

The security model for the OSGi framework is based on the integrity of the Management Agent deployment. If any of the mechanisms used during the deployment of management agents are weak, or can be compromised, the whole security model becomes weak.

From a security perspective, one attractive means of information exchange would be a smart card. This approach enables all relevant information to be stored in a single place. The Operator could then provide the information to the OSGi framework by inserting the smart card into the OSGi framework.

### 110.10.1 Concerns

The major security concerns related to the deployment of the Management Agent are:

- The OSGi framework is controlled by the intended Operator
- The Operator controls the intended OSGi framework(s)
- The integrity and confidentiality of the information exchange that takes place during these processes must be considered

In order to address these concerns, an implementation of the OSGi Remote Management Architecture must assure that:

- The Operator authenticates itself to the OSGi framework
- The OSGi framework authenticates itself to the Operator
- The integrity and confidentiality of the Management Agent, certificates, and configuration data are fully protected if they are transported over public transports.

Each mapping of the Initial Provisioning specification to a concrete implementation must describe how these goals are met.

### 110.10.2 OSGi framework Long-Term Security

Secrets for long-term use may be exchanged during the Initial Provisioning procedures. This way, one or more secrets may be shared securely, assuming that the Provisioning Dictionary assignments used are implemented with the proper security characteristics.

### 110.10.3 Permissions

The provisioning information may contain sensitive information. Also, the ability to modify provisioning information can have drastic consequences. Thus, only trusted bundles should be allowed to register, or get the Provisioning Service. This restriction can be enforced using `ServicePermission[ ProvisioningService, GET]`.

No Permission classes guard reading or modification of the Provisioning Dictionary, so care must be taken not to leak the Dictionary object received from the Provisioning Service to bundles that are not trusted.

Whether message-based or connection-based, the communications used for Initial Provisioning must support mutual authentication and message integrity checking, at a minimum.

By using both server and client authentication in HTTPS, the problem of establishing identity is solved. In addition, HTTPS will encrypt the transmitted data. HTTPS requires a Public Key Infrastructure implementation in order to retrieve the required certificates.

When RSH is used, it is vital that the shared secret is shared only between the Operator and the OSGi framework, and no one else.

## 110.11 org.osgi.service.provisioning

Provisioning Package Version 1.2.

Bundles wishing to use this package must list the package in the Import-Package header of the bundle's manifest. This package has two types of users: the consumers that use the API in this package and the providers that implement the API in this package.

Example import for consumers using the API in this package:

```
Import-Package: org.osgi.service.provisioning; version="[1.2,2.0)"
```

Example import for providers implementing the API in this package:

```
Import-Package: org.osgi.service.provisioning; version="[1.2,1.3]"
```

### 110.11.1 Summary

- ProvisioningService - Service for managing the initial provisioning information.

### 110.11.2 public interface ProvisioningService

Service for managing the initial provisioning information.

Initial provisioning of an OSGi device is a multi step process that culminates with the installation and execution of the initial management agent. At each step of the process, information is collected for the next step. Multiple bundles may be involved and this service provides a means for these bundles to exchange information. It also provides a means for the initial Management Bundle to get its initial configuration information.

The provisioning information is collected in a Dictionary object, called the Provisioning Dictionary. Any bundle that can access the service can get a reference to this object and read and update provisioning information. The key of the dictionary is a String object and the value is a String or byte[] object. The single exception is the PROVISIONING\_UPDATE\_COUNT value which is an Integer. The provisioning prefix is reserved for keys defined by OSGi, other key names may be used for implementation dependent provisioning systems.

Any changes to the provisioning information will be reflected immediately in all the dictionary objects obtained from the Provisioning Service.

Because of the specific application of the Provisioning Service, there should be only one Provisioning Service registered. This restriction will not be enforced by the Framework. Gateway operators or manufactures should ensure that a Provisioning Service bundle is not installed on a device that already has a bundle providing the Provisioning Service.

The provisioning information has the potential to contain sensitive information. Also, the ability to modify provisioning information can have drastic consequences. Thus, only trusted bundles should be allowed to register and get the Provisioning Service. The ServicePermission is used to limit the bundles that can gain access to the Provisioning Service. There is no check of Permission objects to read or modify the provisioning information, so care must be taken not to leak the Provisioning Dictionary received from getInformation method.

*No Implement* Consumers of this API must not implement this interface

#### 110.11.2.1 public static final String INITIALPROVISIONING\_ENTRIES = "InitialProvisioning-Entries"

Name of the header that specifies the type information for the ZIP file entries.

*Since* 1.2

#### 110.11.2.2 public static final String MIME\_BUNDLE = "application/vnd.osgi.bundle"

MIME type to be stored in the extra field of a ZipEntry object for an installable bundle file. Zip entries of this type will be installed in the framework, but not started. The entry will also not be put into the information dictionary.

#### 110.11.2.3 public static final String MIME\_BUNDLE\_ALT = "application/x-osi-gi-bundle"

Alternative MIME type to be stored in the extra field of a ZipEntry object for an installable bundle file. Zip entries of this type will be installed in the framework, but not started. The entry will also not be put into the information dictionary. This alternative entry is only for backward compatibility, new applications are recommended to use MIME\_BUNDLE, which is an official IANA MIME type.

*Since* 1.2

- 110.11.2.4**      **public static final String MIME\_BUNDLE\_URL = "text/x-osgi-bundle-url"**  
 MIME type to be stored in the extra field of a ZipEntry for a String that represents a URL for a bundle. Zip entries of this type will be used to install (but not start) a bundle from the URL. The entry will not be put into the information dictionary.
- 110.11.2.5**      **public static final String MIME\_BYTE\_ARRAY = "application/octet-stream"**  
 MIME type to be stored in the extra field of a ZipEntry object for byte[] data.
- 110.11.2.6**      **public static final String MIME\_STRING = "text/plain;charset=utf-8"**  
 MIME type to be stored in the extra field of a ZipEntry object for String data.
- 110.11.2.7**      **public static final String PROVISIONING\_AGENT\_CONFIG = "provisioning.agent.config"**  
 The key to the provisioning information that contains the initial configuration information of the initial Management Agent. The value will be of type byte[].
- 110.11.2.8**      **public static final String PROVISIONING\_REFERENCE = "provisioning.reference"**  
 The key to the provisioning information that contains the location of the provision data provider. The value must be of type String.
- 110.11.2.9**      **public static final String PROVISIONING\_ROOTX509 = "provisioning.rootx509"**  
 The key to the provisioning information that contains the root X509 certificate used to establish trust with operator when using HTTPS.
- 110.11.2.10**     **public static final String PROVISIONING\_RSH\_SECRET = "provisioning.rsh.secret"**  
 The key to the provisioning information that contains the shared secret used in conjunction with the RSH protocol.
- 110.11.2.11**     **public static final String PROVISIONING\_SPID = "provisioning.spid"**  
 The key to the provisioning information that uniquely identifies the Service Platform. The value must be of type String.
- 110.11.2.12**     **public static final String PROVISIONING\_START\_BUNDLE = "provisioning.start.bundle"**  
 The key to the provisioning information that contains the location of the bundle to start with AllPermission. The bundle must have be previously installed for this entry to have any effect.
- 110.11.2.13**     **public static final String PROVISIONING\_UPDATE\_COUNT = "provisioning.update.count"**  
 The key to the provisioning information that contains the update count of the info data. Each set of changes to the provisioning information must end with this value being incremented. The value must be of type Integer. This key/value pair is also reflected in the properties of the ProvisioningService in the service registry.
- 110.11.2.14**     **public void addInformation(Dictionary info)**  
*info* the set of Provisioning Information key/value pairs to add to the Provisioning Information dictionary. Any keys are values that are of an invalid type will be silently ignored.  
 □ Adds the key/value pairs contained in info to the Provisioning Information dictionary. This method causes the PROVISIONING\_UPDATE\_COUNT to be incremented.
- 110.11.2.15**     **public void addInformation(ZipInputStream zis) throws IOException**  
*zis* the ZipInputStream that will be used to add key/value pairs to the Provisioning Information dictionary and install and start bundles. If a ZipEntry does not have an Extra field that corresponds to one of the four defined MIME types (MIME\_STRING, MIME\_BYTE\_ARRAY, MIME\_BUNDLE, and MIME\_BUNDLE\_URL) in will be silently ignored.



- Processes the `ZipInputStream` and extracts information to add to the Provisioning Information dictionary, as well as, install/update and start bundles. This method causes the `PROVISIONING_UPDATE_COUNT` to be incremented.

*Throws* `IOException`— if an error occurs while processing the `ZipInputStream`. No additions will be made to the Provisioning Information dictionary and no bundles must be started or installed.

#### 110.11.2.16 **public Dictionary getInformation()**

- Returns a reference to the Provisioning Dictionary. Any change operations (put and remove) to the dictionary will cause an `UnsupportedOperationException` to be thrown. Changes must be done using the `setInformation` and `addInformation` methods of this service.

*Returns* A reference to the Provisioning Dictionary.

#### 110.11.2.17 **public void setInformation(Dictionary info)**

*info* the new set of Provisioning Information key/value pairs. Any keys are values that are of an invalid type will be silently ignored.

- Replaces the Provisioning Information dictionary with the key/value pairs contained in `info`. Any key/value pairs not in `info` will be removed from the Provisioning Information dictionary. This method causes the `PROVISIONING_UPDATE_COUNT` to be incremented.

## 110.12 References

- [1] *HMAC: Keyed-Hashing for Message Authentication*  
<http://www.ietf.org/rfc/rfc2104.txt> Krawczyk ,et. al. 1997.
- [2] *NIST, FIPS PUB 180-1: Secure Hash Standard, April 1995.*
- [3] *Hypertext Transfer Protocol - HTTP/1.1*  
<http://www.ietf.org/rfc/rfc2616.txt> Fielding, R., et. al.
- [4] *Rescorla, E., HTTP over TLS, IETF RFC 2818, May 2000*  
<http://www.ietf.org/rfc/rfc2818.txt>.
- [5] *ZIP Archive format*  
<http://www.pkware.com/support/zip-app-note/archives>
- [6] *RFC 2396 - Uniform Resource Identifier (URI)*  
<http://www.ietf.org/rfc/rfc2396.txt>
- [7] *MIME Types*  
<http://www.ietf.org/rfc/rfc2046.txt>  
<http://www.iana.org/assignments/media-types>
- [8] *3DES*  
W/ Tuchman, "Hellman Presents No Shortcut Solution to DES," *IEEE Spectrum*, v. 16, n. 7 July 1979, pp40-41.
- [9] *RFC 1423 Part III: Algorithms, Modes, and Identifiers*  
<http://www.ietf.org/rfc/rfc1423.txt>
- [10] *PKCS 5*  
<ftp://ftp.rsasecurity.com/pub/pkcs/pkcs-5v2>
- [11] *Java Cryptography API (part of Java 1.4)*  
<http://www.oracle.com/technetwork/java/javase/tech/index-jsp-136007.html/>
- [12] *SHA-1*  
U.S. Government, Proposed Federal Information Processing Standard for Secure Hash Standard, January 1992

- [13] *Transport Layer Security*  
<http://www.ietf.org/rfc/rfc2246.txt>, January 1999, The TLS Protocol Version 1.0, T. Dierks & C. Allen.

# 111 UPnP™ Device Service Specification

## Version 1.2

### 111.1 Introduction

The UPnP Device Architecture specification provides the protocols for a peer-to-peer network. It specifies how to join a network and how devices can be controlled using XML messages sent over HTTP. The OSGi specifications address how code can be download and managed in a remote system. Both standards are therefore fully complimentary. Using an OSGi Framework to work with UPnP enabled devices is therefore a very successful combination.

This specification specifies how OSGi bundles can be developed that interoperate with UPnP™ (Universal Plug and Play) devices and UPnP control points. The specification is based on the UPnP Device Architecture and does not further explain the UPnP specifications. The UPnP specifications are maintained by [1] *UPnP Forum*.

UPnP™ is a trademark of the UPnP Implementers Corporation.

#### 111.1.1 Essentials

- *Scope* - This specification is limited to device control aspects of the UPnP specifications. Aspects concerning the TCP/IP layer, like DHCP and limited TTL, are not addressed.
- *Transparency* - OSGi services should be made available to networks with UPnP enabled devices in a transparent way.
- *Network Selection* - It must be possible to restrict the use of the UPnP protocols to a selection of the connected networks. For example, in certain cases OSGi services that are UPnP enabled should not be published to the Wide Area Network side of a gateway, nor should UPnP devices be detected on this WAN.
- *Event handling* - Bundles must be able to listen to UPnP events.
- *Export OSGi services as UPnP devices* - Enable bundles that make a service available to UPnP control points.
- *Implement UPnP Control Points* - Enable bundles that control UPnP devices.

#### 111.1.2 Entities

- *UPnP Base Driver* - The bundle that implements the bridge between OSGi and UPnP networks. This entity is not represented as a service.
- *UPnP Root Device* - A physical device can contain one or more root devices. Root devices contain one ore more devices. A root device is modeled with a UPnPDevice object, there is no separate interface defined for root devices.
- *UPnP Device* - The representation of a UPnP device. A UPnP device may contain other UPnP devices and UPnP services. This entity is represented by a UPnPDevice object. A device can be local (implemented in the Framework) or external (implemented by another device on the net).

- *UPnP Service* - A UPnP device consists of a number of services. A UPnP service has a number of UPnP state variables that can be queried and modified with actions. This concept is represented by a UPnPService object.
- *UPnP Action* - A UPnP service is associated with a number of actions that can be performed on that service and that may modify the UPnP state variables. This entity is represented by a UPnPAction object.
- *UPnP State Variable* - A variable associated with a UPnP service, represented by a UPnPStateVariable object.
- *UPnP Local State Variable* - Extends the UPnPStateVariable interface when the state variable is implemented locally. This interface provides access to the actual value.
- *UPnP Event Listener Service* - A listener to events coming from UPnP devices.
- *UPnP Host* - The machine that hosts the code to run a UPnP device or control point.
- *UPnP Control Point* - A UPnP device that is intended to control UPnP devices over a network. For example, a UPnP remote controller.
- *UPnP Icon* - A representation class for an icon associated with a UPnP device.
- *UPnP Exception* - An exception that delivers errors that were discovered in the UPnP layer.
- *UDN* - Unique Device Name, a name that uniquely identifies the a specific device.

Figure 111.1 UPnP Service Specification class Diagram org.osgi.service.upnp package

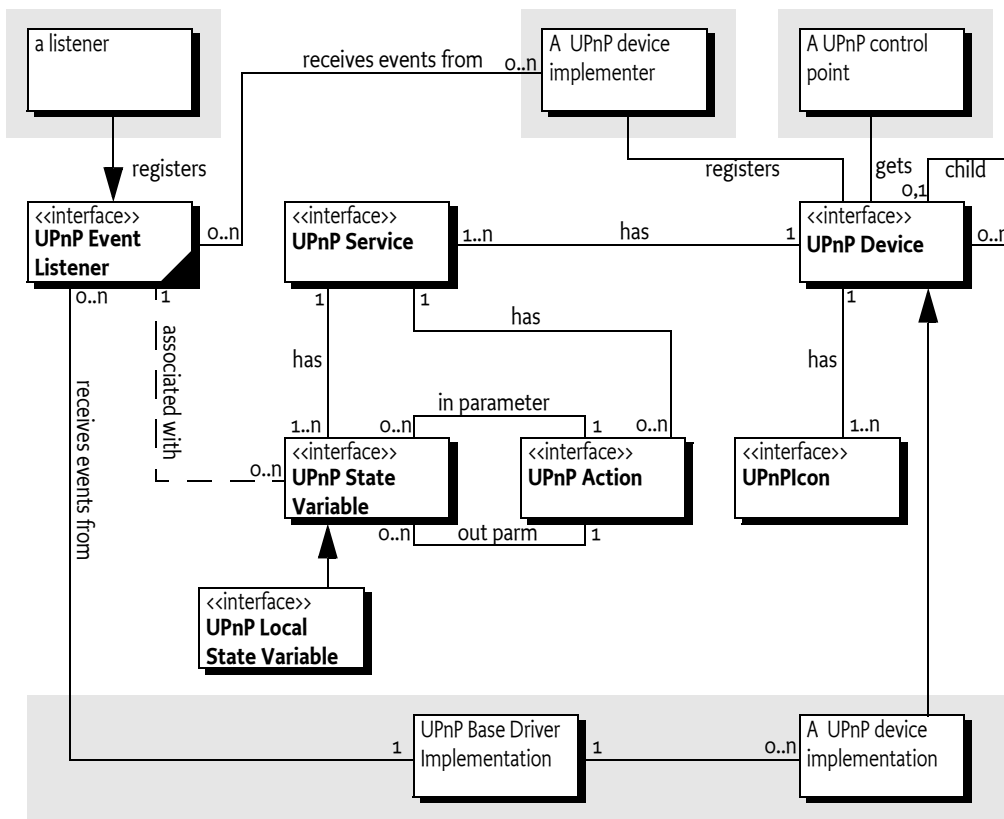

### 111.1.3 Operation Summary

To make a UPnP service available to UPnP control points on a network, an OSGi service object must be registered under the UPnPDevice interface with the Framework. The UPnP driver bundle must de-

tect these UPnP Device services and must make them available to the network as UPnP devices using the UPnP protocol.

UPnP devices detected on the local network must be detected and automatically registered under the UPnPDevice interface with the Framework by the UPnP driver implementation bundle.

A bundle that wants to control UPnP devices, for example to implement a UPnP control point, should track UPnP Device services in the OSGi service registry and control them appropriately. Such bundles should not distinguish between resident or remote UPnP Device services.

## 111.2 UPnP Specifications

The UPnP DA is intended to be used in a broad range of device from the computing (PCs printers), consumer electronics (DVD, TV, radio), communication (phones) to home automation (lighting control, security) and home appliances (refrigerators, coffee makers) domains.

For example, a UPnP TV might announce its existence on a network by broadcasting a message. A UPnP control point on that network can then discover this TV by listening to those announce messages. The UPnP specifications allow the control point to retrieve information about the user interface of the TV. This information can then be used to allow the end user to control the remote TV from the control point, for example turn it on or change the channels.

The UPnP specification supports the following features:

- *Detect and control a UPnP standardized device.* In this case the control point and the remote device share a priori knowledge about how the device should be controlled. The UPnP Forum intends to define a large number of these standardized devices.
- *Use a user interface description.* A UPnP control point receives enough information about a device and its services to automatically build a user interface for it.
- *Programmatic Control.* A program can directly control a UPnP device without a user interface. This control can be based on detected information about the device or through a priori knowledge of the device type.
- *Allows the user to browse a web page supplied by the device.* This web page contains a user interface for the device that be directly manipulated by the user. However, this option is not well defined in the UPnP Device Architecture specification and is not tested for compliance.

The UPnP Device Architecture specification and the OSGi Framework provide *complementary* functionality. The UPnP Device Architecture specification is a data communication protocol that does not specify where and how programs execute. That choice is made by the implementations. In contrast, the OSGi Framework specifies a (managed) execution point and does not define what protocols or media are supported. The UPnP specification and the OSGi specifications are fully complementary and do not overlap.

From the OSGi perspective, the UPnP specification is a communication protocol that can be implemented by one or more bundles. This specification therefore defines the following:

- How an OSGi bundle can implement a service that is exported to the network via the UPnP protocols.
- How to find and control services that are available on the local network.

The UPnP specifications related to the assignment of IP addresses to new devices on the network or auto-IP self configuration should be handled at the operating system level. Such functions are outside the scope of this specification.

**111.2.1****UPnP Base Driver**

The functionality of the UPnP service is implemented in a UPnP *base driver*. This is a bundle that implements the UPnP protocols and handles the interaction with bundles that use the UPnP devices. A UPnP base driver bundle must provide the following functions:

- Discover UPnP devices on the network and map each discovered device into an OSGi registered UPnP Device service.
- Present UPnP marked services that are registered with the OSGi Framework on one or more networks to be used by other computers.

**111.3****UPnP Device**

The principle entity of the UPnP specification is the UPnP device. There is a UPnP *root device* that represents a physical appliance, such as a complete TV. The root device contains a number of sub-devices. These might be the tuner, the monitor, and the sound system. Each sub-device is further composed of a number of UPnP services. A UPnP service represents some functional unit in a device. For example, in a TV tuner it can represent the TV channel selector. Figure 111.2 on page 266 illustrates this hierarchy.

Figure 111.2

UPnP device hierarchy

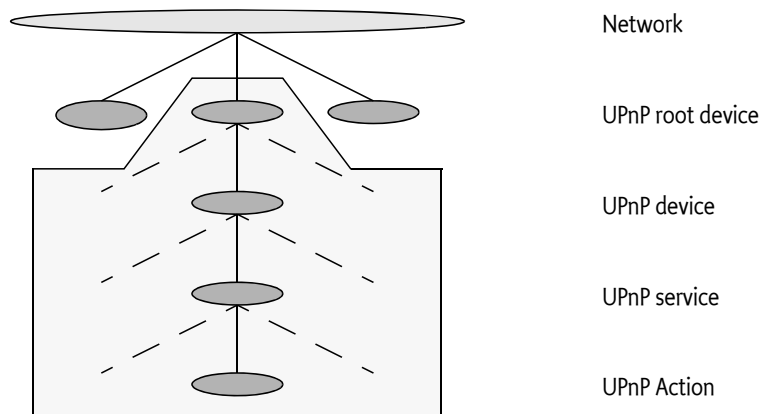

Each UPnP service can be manipulated with a number of UPnP actions. UPnP actions can modify the state of a UPnP state variable that is associated with a service. For example, in a TV there might be a state variable *volume*. There are then actions to set the volume, to increase the volume, and to decrease the volume.

**111.3.1****Root Device**

The UPnP root device is registered as a UPnP Device service with the Framework, as well as all its sub-devices. Most applications will work with sub-devices, and, as a result, the children of the root device are registered under the UPnPDevice interface.

UPnP device properties are defined per sub-device in the UPnP specification. These properties must be registered with the OSGi Framework service registry so they are searchable.

Bundles that want to handle the UPnP device hierarchy can use the registered service properties to find the parent of a device (which is another registered UPnPDevice).

The following service registration properties can be used to discover this hierarchy:

- [PARENT\\_UDN](#) - (String) The Universal Device Name (UDN) of the parent device. A root device most not have this property registered. Type is a String object.
- [CHILDREN\\_UDN](#) - (String[]) An array of UDNs of this device's children.

### 111.3.2 Exported Versus Imported Devices

Both imported (from the network to the OSGi service registry) and exported (from the service registry to the network) UPnPDevice services must have the same representation in the OSGi Framework for identical devices. For example, if an OSGi UPnP Device service is exported as a UPnP device from an OSGi Framework to the network, and it is imported into another OSGi Framework, the object representation should be equal. Application bundles should therefore be able to interact with imported and exported forms of the UPnP device in the same manner.

Imported and exported UPnP devices differ only by two marker properties that can be added to the service registration. One marker, [DEVICE\\_CATEGORY](#), should typically be set only on imported devices. By not setting [DEVICE\\_CATEGORY](#) on internal UPnP devices, the Device Manager does not try to refine these devices (See the *Device Access Specification* on page 61 for more information about the Device Manager). If the device service does not implement the Device interface and does not have the [DEVICE\\_CATEGORY](#) property set, it is not considered a *device* according to the Device Access Specification.

The other marker, [UPNP\\_EXPORT](#), should only be set on internally created devices that the bundle developer wants to export. By not setting [UPNP\\_EXPORT](#) on registered UPnP Device services, the UPnP Device service can be used by internally created devices that should not be exported to the network. This allows UPnP devices to be simulated within an OSGi Framework without announcing all of these devices to any networks.

The [UPNP\\_EXPORT](#) service property has no defined type, any value is correct.

### 111.3.3 Icons

A UPnP device can optionally support an icon. The purpose of this icon is to identify the device on a UPnP control point. UPnP control points can be implemented in large computers like PC's or simple devices like a remote control. However, the graphic requirements for these UPnP devices differ tremendously. The device can, therefore, export a number of icons of different size and depth.

In the UPnP specifications, an icon is represented by a URL that typically refers to the device itself. In this specification, a list of icons is available from the UPnP Device service.

In order to obtain localized icons, the method [getIcons\(String\)](#) can be used to obtain different versions. If the locale specified is a null argument, then the call returns the icons of the default locale of the called device (not the default locale of the UPnP control point). When a bundle wants to access the icon of an imported UPnP device, the UPnP driver gets the data and presents it to the application through an input stream.

A bundle that needs to export a UPnP Device service with one or more icons must provide an implementation of the UPnPIcon interface. This implementation must provide an `InputStream` object to the actual icon data. The UPnP driver bundle must then register this icon with an HTTP server and include the URL to the icon with the UPnP device data at the appropriate place.

## 111.4 Device Category

UPnP Device services are devices in the context of the Device Manager. This means that these services need to register with a number of properties to participate in driver refinement. The value for UPnP devices is defined in the UPnPDevice constant [DEVICE\\_CATEGORY](#). The value is UPnP. The UPnPDevice interface contains a number of constants for matching values. Refer to [MATCH\\_GENERIC](#) for further information.

## 111.5 UPnPService

A UPnP Device contains a number of UPnPService objects. UPnPService objects combine zero or more actions and one or more state variables.

### 111.5.1 State Variables

The UPnPStateVariable interface encapsulates the properties of a UPnP state variable. In addition to the properties defined by the UPnP specification, a state variable is also mapped to a Java data type. The Java data type is used when an event is generated for this state variable and when an action is performed containing arguments related to this state variable. There must be a strict correspondence between the UPnP data type and the Java data type so that bundles using a particular UPnP device profile can predict the precise Java data type.

The function QueryStateVariable defined in the UPnP specification has been deprecated and is therefore not implemented. It is recommended to use the UPnP event mechanism to track UPnP state variables.

Additionally, a UPnPStateVariable object can also implement the UPnPLocalStateVariable interface if the device is implemented locally. That is, the device is not imported from the network. The UPnPLocalStateVariable interface provides a `getCurrentValue()` method that provides direct access to the actual value of the state variable.

## 111.6 Working With a UPnP Device

The UPnP driver must register all discovered UPnP devices in the local networks. These devices are registered under a UPnPDevice interface with the OSGi Framework.

Using a remote UPnP device thus involves tracking UPnP Device services in the OSGi service registry. The following code illustrates how this can be done. The sample Controller class extends the ServiceTracker class so that it can track all UPnP Device services and add them to a user interface, such as a remote controller application.

```
class Controller extends ServiceTracker {
    UI ui;

    Controller( BundleContext context ) {
        super( context, UPnPDevice.class.getName(), null );
    }
    public Object addingService( ServiceReference ref ) {
        UPnPDevice dev = (UPnPDevice)super.addingService(ref);
        ui.addDevice( dev );
        return dev;
    }
    public void removedService( ServiceReference ref,
        Object dev ) {
        ui.removeDevice( (UPnPDevice) dev );
    }
    ...
}
```



## 111.7 Implementing a UPnP Device

OSGi services can also be exported as UPnP devices to the local networks, in a way that is transparent to typical UPnP devices. This allows developers to bridge legacy devices to UPnP networks. A bundle should perform the following to export an OSGi service as a UPnP device:

- Register an UPnP Device service with the registration property `UPNP_EXPORT`.
- Use the registration property `PRESENTATION_URL` to provide the presentation page. The service implementer must register its own servlet with the Http Service to serve out this interface. This URL must point to that servlet.

There can be multiple UPnP root devices hosted by one OSGi platform. The relationship between the UPnP devices and the OSGi platform is defined by the `PARENT_UDN` and `CHILDREN_UDN` service properties. The bundle registering those device services must make sure these properties are set accordingly.

Devices that are implemented on the OSGi Framework (in contrast with devices that are imported from the network) should use the `UPnPLocalStateVariable` interface for their state variables instead of the `UPnPStateVariable` interface. This interface provides programmatic access to the actual value of the state variable as maintained by the device specific code.

## 111.8 Event API

There are two distinct event directions for the UPnP Service specification.

- External events from the network must be dispatched to listeners inside the OSGi Frameworks. The UPnP Base driver is responsible for mapping the network events to internal listener events.
- Implementations of UPnP devices must send out events to local listeners as well as cause the transmission of the UPnP network events.

UPnP events are sent using the whiteboard model, in which a bundle interested in receiving the UPnP events registers an object implementing the `UPnPEventListener` interface. A filter can be set to limit the events for which a bundle is notified. The UPnP Base driver must register a UPnP Event Listener without filter that receives all events.

Figure 111.3 Event Dispatching for Local and External Devices

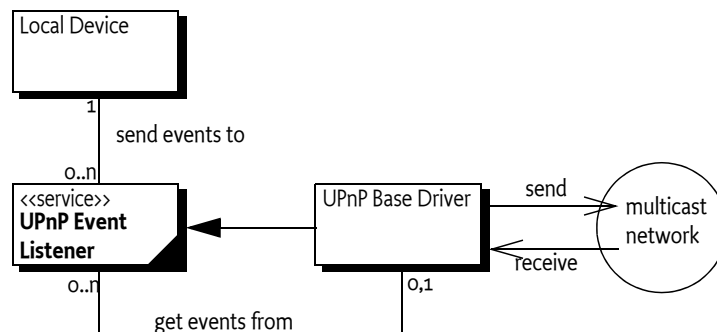

If a service is registered with a property named `upnp.filter` with the value of an instance of a `Filter` object, the listener is only notified for matching events (This is a `Filter` object and not a `String` object because it allows the `InvalidSyntaxException` to be thrown in the client and not the UPnP driver bundle).

The filter might refer to any valid combination of the following pseudo properties for event filtering:

- UPnPDevice.**UDN** - (UPnP.device.UDN/String) Only events generated by services contained in the specific device are delivered. For example: (UPnP.device.UDN=uuid:Upnp-TVEmulator-1\_0-1234567890001)
- UPnPDevice.**TYPE** - (UPnP.device.type/String or String[]) Only events generated by services contained in a device of the given type are delivered. For example: (UPnP.device.type=urn:schemas-upnp-org:device:tvdevice:1)
- UPnPService.**ID** - (UPnP.service.id/String) Service identity. Only events generated by services matching the given service ID are delivered.
- UPnPService.**TYPE** - (UPnP.service.type/String or String[]) Only events generated by services of the given type are delivered.

If an event is generated by either a local device or via the base driver for an external device, the `notifyUPnPEvent(String,String,Dictionary)` method is called on all registered `UPnPEventListener` services for which the optional filter matches for that event. If no filter is specified, all events must be delivered. If the filter does not match, the UPnP Driver must not call the UPnP Event Listener service. The way events must be delivered is the same as described in *Delivering Events of OSGi Core Release 6*.

One or multiple events are passed as parameters to the `notifyUPnPEvent(String,String,Dictionary)` method. The Dictionary object holds a pair of `UpnPStateVariable` objects that triggered the event and an Object for the new value of the state variable.

### 111.8.1 Initial Event Delivery

Special care must be taken with the initial subscription to events. According to the UPnP specification, when a client subscribes for notification of events for the first time, the device sends out a number of events for each state variable, indicating the current value of each state variable. This behavior simplifies the synchronization of a device and an event-driven client.

The UPnP Base Driver must mimic this event distribution on behalf of external devices. It must therefore remember the values of the state variables of external devices. A UPnP Device implementation must send out these initial events for each state variable they have a value for.

The UPnP Base Driver must have stored the last event from the device and retransmit the value over the multicast network. The UPnP Driver must register an event listener without any filter for this purpose.

The call to the listener's notification method must be done asynchronously.

## 111.9 UPnP Events and Event Admin service

UPnP events must be delivered asynchronously to the Event Admin service by the UPnP implementation, if present. UPnP events have the following topic:

`org/osgi/service/upnp/UPnPEvent`

The properties of a UPnP event are the following:

- `upnp.deviceId` - (String) The identity as defined by UPnPDevice.**UDN** of the device sending the event.
- `upnp.serviceId` - (String) The identity of the service sending the events.
- `upnp.events` - (Dictionary) A Dictionary object containing the new values for the state variables that have changed.

## 111.10 Localization

All values of the UPnP properties are obtained from the device using the device's default locale. If an application wants to query a set of localized property values, it has to use the method `getDescriptions(String)`. For localized versions of the icons, the method `getIcons(String)` is to be used.

## 111.11 Dates and Times

The UPnP specification uses different types for date and time concepts. An overview of these types is given in the following table.

Table 111.1 Mapping UPnP Date/Time types to Java

UPnP Type	Class	Example	Value (TZ=CEST=UTC+0200)
date	Date	1985-04-12	Sun April 12 00:00:00 CEST 1985
dateTime	Date	1985-04-12T10:15:30	Sun April 12 10:15:30 CEST 1985
dateTime.tz	Date	1985-04-12T10:15:30+0400	Sun April 12 08:15:30 CEST 1985
time	Long	23:20:50	84.050.000 (ms)
time.tz	Long	23:20:50+0100	1.250.000 (ms)

The UPnP specification points to [2] *XML Schema*. In this standard, [3] *ISO 8601 Date And Time formats* are referenced. The mapping is not completely defined which means that this OSGi UPnP specification defines a complete mapping to Java classes. The UPnP types `date`, `dateTime` and `dateTime.tz` are represented as a `Date` object. For the date type, the hours, minutes and seconds must all be zero.

The UPnP types `time` and `time.tz` are represented as a `Long` object that represents the number of ms since midnight. If the time wraps to the next day due to a time zone value, then the final value must be truncated modulo 86.400.000.

See also [TYPE\\_DATE](#).

## 111.12 UPnP Exception

The UPnP Exception can be thrown when a `UPnPAction` is invoked. This exception contains information about the different UPnP layers. The following errors are defined:

[INVALID\\_ACTION](#) - (401) No such action could be found.

[INVALID\\_ARGS](#) - (402) Invalid argument.

[INVALID\\_SEQUENCE\\_NUMBER](#) - (403) Out of synchronization.

[INVALID\\_VARIABLE](#) - (404) State variable not found.

[DEVICE\\_INTERNAL\\_ERROR](#) - (501) Internal error.

Further errors are categorized as follows:

- *Common Action Errors* - In the range of 600-69, defined by the UPnP Forum Technical Committee.
- *Action Specific Errors* - In the range of 700-799, defined by the UPnP Forum Working Committee.
- *Non-Standard Action Specific Errors* - In the range of 800-899. Defined by vendors.

## 111.13 Configuration

In order to provide a standardized way to configure a UPnP driver bundle, the Configuration Admin property `upnp.ssdp.address` is defined.

The value is a `String[]` with a list of IP addresses, optionally followed with a colon (':') and a port number. For example:

```
239.255.255.250:1900
```

Those addresses define the interfaces which the UPnP driver is operating on. If no SSDP address is specified, the default assumed will be `239.255.255.250:1900`. If no port is specified, port 1900 is assumed as default.

## 111.14 Networking considerations

### 111.14.1 The UPnP Multicasts

The operating system must support multicasting on the selected network device. In certain cases, a multicasting route has to be set in the operating system routing table.

These configurations are highly dependent on the underlying operating system and beyond the scope of this specification.

## 111.15 Security

The UPnP specification is based on HTTP and uses plain text SOAP (XML) messages to control devices. For this reason, it does not provide any inherent security mechanisms. However, the UPnP specification is based on the exchange of XML files and not code. This means that at least worms and viruses cannot be implemented using the UPnP protocols.

However, a bundle registering a UPnP Device service is represented on the outside network and has the ability to communicate. The same is true for getting a UPnP Device service. It is therefore recommended that `ServicePermission[UPnPDevice|UPnPEventListener, REGISTER|GET]` be used sparingly and only for bundles that are trusted.

## 111.16 `org.osgi.service.upnp`

UPnP Package Version 1.2.

Bundles wishing to use this package must list the package in the `Import-Package` header of the bundle's manifest. This package has two types of users: the consumers that use the API in this package and the providers that implement the API in this package.

Example import for consumers using the API in this package:

```
Import-Package: org.osgi.service.upnp; version="[1.2,2.0]"
```

Example import for providers implementing the API in this package:

```
Import-Package: org.osgi.service.upnp; version="[1.2,1.3]"
```

**111.16.1 Summary**

- UPnPAction - A UPnP action.
- UPnPDevice - Represents a UPnP device.
- UPnPEventListener - UPnP Events are mapped and delivered to applications according to the OSGi whiteboard model.
- UPnPException - There are several defined error situations describing UPnP problems while a control point invokes actions to UPnPDevices.
- UPnPIcon - A UPnP icon representation.
- UPnPLocalStateVariable - A local UPnP state variable which allows the value of the state variable to be queried.
- UPnPService - A representation of a UPnP Service.
- UPnPStateVariable - The meta-information of a UPnP state variable as declared in the device's service state table (SST).

**111.16.2 public interface UPnPAction**

A UPnP action. Each UPnP service contains zero or more actions. Each action may have zero or more UPnP state variables as arguments.

**111.16.2.1 public String[] getInputArgumentNames()**

- Lists all input arguments for this action.

Each action may have zero or more input arguments.

This method must continue to return the action input argument names after the UPnP action has been removed from the network.

*Returns* Array of input argument names or null if no input arguments.

*See Also* UPnPStateVariable

**111.16.2.2 public String getName()**

- Returns the action name. The action name corresponds to the name field in the actionList of the service description.
  - For standard actions defined by a UPnP Forum working committee, action names must not begin with X\_ nor A\_.
  - For non-standard actions specified by a UPnP vendor and added to a standard service, action names must begin with X\_.

This method must continue to return the action name after the UPnP action has been removed from the network.

*Returns* Name of action, must not contain a hyphen character or a hash character

**111.16.2.3 public String[] getOutputArgumentNames()**

- List all output arguments for this action.

This method must continue to return the action output argument names after the UPnP action has been removed from the network.

*Returns* Array of output argument names or null if there are no output arguments.

*See Also* UPnPStateVariable

**111.16.2.4 public String getReturnArgumentName()**

- Returns the name of the designated return argument.

One of the output arguments can be flagged as a designated return argument.

This method must continue to return the action return argument name after the UPnP action has been removed from the network.

*Returns* The name of the designated return argument or null if none is marked.

#### 111.16.2.5 **public UPnPStateVariable getStateVariable(String argumentName)**

*argumentName* The name of the UPnP action argument.

- Finds the state variable associated with an argument name. Helps to resolve the association of state variables with argument names in UPnP actions.

*Returns* State variable associated with the named argument or null if there is no such argument.

*Throws* `IllegalStateException`– if the UPnP action has been removed from the network.

*See Also* `UPnPStateVariable`

#### 111.16.2.6 **public Dictionary invoke(Dictionary args) throws Exception**

*args* A Dictionary of arguments. Must contain the correct set and type of arguments for this action. May be null if no input arguments exist.

- Invokes the action. The input and output arguments are both passed as Dictionary objects. Each entry in the Dictionary object has a String object as key representing the argument name and the value is the argument itself. The class of an argument value must be assignable from the class of the associated UPnP state variable. The input argument Dictionary object must contain exactly those arguments listed by `getInputArguments` method. The output argument Dictionary object will contain exactly those arguments listed by `getOutputArguments` method.

*Returns* A Dictionary with the output arguments. null if the action has no output arguments.

*Throws* `UPnPException`– A UPnP error has occurred.

`IllegalStateException`– if the UPnP action has been removed from the network.

`Exception`– The execution fails for some reason.

*See Also* `UPnPStateVariable`

### 111.16.3 **public interface UPnPDevice**

Represents a UPnP device. For each UPnP root and embedded device, an object is registered with the framework under the `UPnPDevice` interface.

The relationship between a root device and its embedded devices can be deduced using the `UPnPDevice.CHILDREN_UDN` and `UPnPDevice.PARENT_UDN` service registration properties.

The values of the UPnP property names are defined by the UPnP Forum.

All values of the UPnP properties are obtained from the device using the device's default locale.

If an application wants to query for a set of localized property values, it has to use the method `UPnPDevice.getDescriptions(String locale)`.

#### 111.16.3.1 **public static final String CHILDREN\_UDN = "UPnP.device.childrenUDN"**

The property key that must be set for all devices containing other embedded devices.

The value is an array of UDNs for each of the device's children (`String[]`). The array contains UDNs for the immediate descendants only.

If an embedded device in turn contains embedded devices, the latter are not included in the array.

The UPnP Specification does not encourage more than two levels of nesting.

The property is not set if the device does not contain embedded devices.

The property is of type `String[]`. Value is `"UPnP.device.childrenUDN"`

**111.16.3.2      `public static final String DEVICE_CATEGORY = "UPnP"`**

Constant for the value of the service property `DEVICE_CATEGORY` used for all UPnP devices. Value is `"UPnP"`.

*See Also* `org.osgi.service.device.Constants.DEVICE_CATEGORY`

**111.16.3.3      `public static final String FRIENDLY_NAME = "UPnP.device.friendlyName"`**

Mandatory property key for a short user friendly version of the device name. The property value holds a `String` object with the user friendly name of the device. Value is `"UPnP.device.friendlyName"`.

**111.16.3.4      `public static final String ID = "UPnP.device.UDN"`**

Property key for the Unique Device ID property. This property is an alias to `UPnPDevice.UDN`. It is merely provided for reasons of symmetry with the `UPnPService.ID` property. The value of the property is a `String` object of the Device UDN. The value of the key is `"UPnP.device.UDN"`.

**111.16.3.5      `public static final String MANUFACTURER = "UPnP.device.manufacturer"`**

Mandatory property key for the device manufacturer's property. The property value holds a `String` representation of the device manufacturer's name. Value is `"UPnP.device.manufacturer"`.

**111.16.3.6      `public static final String MANUFACTURER_URL = "UPnP.device.manufacturerURL"`**

Optional property key for a URL to the device manufacturers Web site. The value of the property is a `String` object representing the URL. Value is `"UPnP.device.manufacturerURL"`.

**111.16.3.7      `public static final int MATCH_GENERIC = 1`**

Constant for the UPnP device match scale, indicating a generic match for the device. Value is 1.

**111.16.3.8      `public static final int MATCH_MANUFACTURER_MODEL = 7`**

Constant for the UPnP device match scale, indicating a match with the device model. Value is 7.

**111.16.3.9      `public static final int MATCH_MANUFACTURER_MODEL_REVISION = 15`**

Constant for the UPnP device match scale, indicating a match with the device revision. Value is 15.

**111.16.3.10     `public static final int MATCH_MANUFACTURER_MODEL_REVISION_SERIAL = 31`**

Constant for the UPnP device match scale, indicating a match with the device revision and the serial number. Value is 31.

**111.16.3.11     `public static final int MATCH_TYPE = 3`**

Constant for the UPnP device match scale, indicating a match with the device type. Value is 3.

**111.16.3.12     `public static final String MODEL_DESCRIPTION = "UPnP.device.modelDescription"`**

Optional (but recommended) property key for a `String` object with a long description of the device for the end user. The value is `"UPnP.device.modelDescription"`.

**111.16.3.13     `public static final String MODEL_NAME = "UPnP.device.modelName"`**

Mandatory property key for the device model name. The property value holds a `String` object giving more information about the device model. Value is `"UPnP.device.modelName"`.

**111.16.3.14     `public static final String MODEL_NUMBER = "UPnP.device.modelNumber"`**

Optional (but recommended) property key for a `String` class typed property holding the model number of the device. Value is `"UPnP.device.modelNumber"`.

**111.16.3.15 public static final String MODEL\_URL = "UPnP.device.modelURL"**

Optional property key for a String typed property holding a string representing the URL to the Web site for this model. Value is "UPnP.device.modelURL".

**111.16.3.16 public static final String PARENT\_UDN = "UPnP.device.parentUDN"**

The property key that must be set for all embedded devices. It contains the UDN of the parent device. The property is not set for root devices. The value is "UPnP.device.parentUDN".

**111.16.3.17 public static final String PRESENTATION\_URL = "UPnP.presentationURL"**

Optional (but recommended) property key for a String typed property holding a string representing the URL to a device representation Web page. Value is "UPnP.presentationURL".

**111.16.3.18 public static final String SERIAL\_NUMBER = "UPnP.device.serialNumber"**

Optional (but recommended) property key for a String typed property holding the serial number of the device. Value is "UPnP.device.serialNumber".

**111.16.3.19 public static final String TYPE = "UPnP.device.type"**

Property key for the UPnP Device Type property. Some standard property values are defined by the Universal Plug and Play Forum. The type string also includes a version number as defined in the UPnP specification. This property must be set.

For standard devices defined by a UPnP Forum working committee, this must consist of the following components in the given order separated by colons:

- urn
- schemas-upnp-org
- device
- a device type suffix
- an integer device version

For non-standard devices specified by UPnP vendors following components must be specified in the given order separated by colons:

- urn
- an ICANN domain name owned by the vendor
- device
- a device type suffix
- an integer device version

To allow for backward compatibility the UPnP driver must automatically generate additional Device Type property entries for smaller versions than the current one. If for example a device announces its type as version 3, then properties for versions 2 and 1 must be automatically generated.

In the case of exporting a UPnPDevice, the highest available version must be announced on the network.

Syntax Example: urn:schemas-upnp-org:device:deviceType:v

The value is "UPnP.device.type".

**111.16.3.20 public static final String UDN = "UPnP.device.UDN"**

Property key for the Unique Device Name (UDN) property. It is the unique identifier of an instance of a UPnPDevice. The value of the property is a String object of the Device UDN. Value of the key is "UPnP.device.UDN". This property must be set.



**111.16.3.21      public static final String UPC = "UPnP.device.UPC"**

Optional property key for a String typed property holding the Universal Product Code (UPC) of the device. Value is "UPnP.device.UPC".

**111.16.3.22      public static final String UPNP\_EXPORT = "UPnP.export"**

The UPnP.export service property is a hint that marks a device to be picked up and exported by the UPnP Service. Imported devices do not have this property set. The registered property requires no value.

The UPNP\_EXPORT string is "UPnP.export".

**111.16.3.23      public Dictionary getDescriptions(String locale)**

*locale* A language tag as defined by RFC 1766 and maintained by ISO 639. Examples include "de", "en" or "en-US". The default locale of the device is specified by passing a null argument.

- Get a set of localized UPnP properties. The UPnP specification allows a device to present different device properties based on the client's locale. The properties used to register the UPnPDevice service in the OSGi registry are based on the device's default locale. To obtain a localized set of the properties, an application can use this method.

Not all properties might be available in all locales. This method does **not** substitute missing properties with their default locale versions.

This method must continue to return the properties after the UPnP device has been removed from the network.

*Returns* Dictionary mapping property name Strings to property value Strings

**111.16.3.24      public UPnPIcon[] getIcons(String locale)**

*locale* A language tag as defined by RFC 1766 and maintained by ISO 639. Examples include "de", "en" or "en-US". The default locale of the device is specified by passing a null argument.

- Lists all icons for this device in a given locale. The UPnP specification allows a device to present different icons based on the client's locale.

*Returns* Array of icons or null if no icons are available.

*Throws* IllegalStateException– if the UPnP device has been removed from the network.

**111.16.3.25      public UPnPService getService(String serviceId)**

*serviceId* The service id

- Locates a specific service by its service id.

*Returns* The requested service or null if not found.

*Throws* IllegalStateException– if the UPnP device has been removed from the network.

**111.16.3.26      public UPnPService[] getServices()**

- Lists all services provided by this device.

*Returns* Array of services or null if no services are available.

*Throws* IllegalStateException– if the UPnP device has been removed from the network.

**111.16.4      public interface UPnPEventListener**

UPnP Events are mapped and delivered to applications according to the OSGi whiteboard model. An application that wishes to be notified of events generated by a particular UPnP Device registers a service extending this interface.

The notification call from the UPnP Service to any UPnPEventListener object must be done asynchronous with respect to the originator (in a separate thread).

Upon registration of the UPnP Event Listener service with the Framework, the service is notified for each variable which it listens for with an initial event containing the current value of the variable. Subsequent notifications only happen on changes of the value of the variable.

A UPnP Event Listener service filter the events it receives. This event set is limited using a standard framework filter expression which is specified when the listener service is registered.

The filter is specified in a property named "upnp.filter" and has as a value an object of type org.osgi.framework.Filter.

When the Filter is evaluated, the following keywords are recognized as defined as literal constants in the UPnPDevice class.

The valid subset of properties for the registration of UPnP Event Listener services are:

- UPnPDevice.TYPE-- Which type of device to listen for events.
- UPnPDevice.ID-- The ID of a specific device to listen for events.
- UPnPService.TYPE-- The type of a specific service to listen for events.
- UPnPService.ID-- The ID of a specific service to listen for events.

#### 111.16.4.1 **public static final String UPNP\_FILTER = "upnp.filter"**

Key for a service property having a value that is an object of type org.osgi.framework.Filter and that is used to limit received events.

#### 111.16.4.2 **public void notifyUPnPEvent(String deviceId,String serviceId,Dictionary events)**

*deviceId* ID of the device sending the events

*serviceId* ID of the service sending the events

*events* Dictionary object containing the new values for the state variables that have changed.

- Callback method that is invoked for received events. The events are collected in a Dictionary object. Each entry has a String key representing the event name (= state variable name) and the new value of the state variable. The class of the value object must match the class specified by the UPnP State Variable associated with the event. This method must be called asynchronously

### 111.16.5 **public class UPnPException extends Exception**

There are several defined error situations describing UPnP problems while a control point invokes actions to UPnPDevices.

*Since* 1.1

#### 111.16.5.1 **public static final int DEVICE\_INTERNAL\_ERROR = 501**

The invoked action failed during execution.

#### 111.16.5.2 **public static final int INVALID\_ACTION = 401**

No Action found by that name at this service.

#### 111.16.5.3 **public static final int INVALID\_ARGS = 402**

Not enough arguments, too many arguments with a specific name, or one of more of the arguments are of the wrong type.

#### 111.16.5.4 **public static final int INVALID\_SEQUENCE\_NUMBER = 403**

The different end-points are no longer in synchronization.

**111.16.5.5      public static final int INVALID\_VARIABLE = 404**

Refers to a non existing variable.

**111.16.5.6      public UPnPException(int errorCode,String errorDescription)**

*errorCode* error code which defined by UPnP Device Architecture V1.0.

*errorDescription* error description which explain the type of problem.

- This constructor creates a UPnPException on the specified error code and error description.

**111.16.5.7      public UPnPException(int errorCode,String errorDescription,Throwable errorCause)**

*errorCode* error code which defined by UPnP Device Architecture V1.0.

*errorDescription* error description which explain the type of the problem.

*errorCause* cause of that UPnPException.

- This constructor creates a UPnPException on the specified error code, error description and error cause.

*Since* 1.2

**111.16.5.8      public int getUPnPError\_Code()**

- Returns the UPnPError Code occurred by UPnPDevices during invocation.

*Returns* The UPnPErrorCode defined by a UPnP Forum working committee or specified by a UPnP vendor.

*Deprecated* As of version 1.2, replaced by getUPnPErrorCode()

**111.16.5.9      public int getUPnPErrorCode()**

- Returns the UPnP Error Code occurred by UPnPDevices during invocation.

*Returns* The UPnPErrorCode defined by a UPnP Forum working committee or specified by a UPnP vendor.

*Since* 1.2

**111.16.6      public interface UPnPIcon**

A UPnP icon representation. Each UPnP device can contain zero or more icons.

**111.16.6.1      public int getDepth()**

- Returns the color depth of the icon in bits.

This method must continue to return the icon depth after the UPnP device has been removed from the network.

*Returns* The color depth in bits. If the actual color depth of the icon is unknown, -1 is returned.

**111.16.6.2      public int getHeight()**

- Returns the height of the icon in pixels. If the actual height of the icon is unknown, -1 is returned.

This method must continue to return the icon height after the UPnP device has been removed from the network.

*Returns* The height in pixels, or -1 if unknown.

**111.16.6.3      public InputStream getInputStream() throws IOException**

- Returns an InputStream object for the icon data. The InputStream object provides a way for a client to read the actual icon graphics data. The number of bytes available from this InputStream object can be determined via the getSize() method. The format of the data encoded can be determined by the MIME type available via the getMimeType() method.

*Returns* An InputStream to read the icon graphics data from.

*Throws* IOException– If the InputStream cannot be returned.

IllegalStateException– if the UPnP device has been removed from the network.

*See Also* UPnPIcon.getMimeType()

#### 111.16.6.4 **public String getMimeType()**

- Returns the MIME type of the icon. This method returns the format in which the icon graphics, read from the InputStream object obtained by the getInputStream() method, is encoded.

The format of the returned string is in accordance to RFC2046. A list of valid MIME types is maintained by the IANA [<http://www.iana.org/assignments/media-types/>].

Typical values returned include: "image/jpeg" or "image/gif"

This method must continue to return the icon MIME type after the UPnP device has been removed from the network.

*Returns* The MIME type of the encoded icon.

#### 111.16.6.5 **public int getSize()**

- Returns the size of the icon in bytes. This method returns the number of bytes of the icon available to read from the InputStream object obtained by the getInputStream() method. If the actual size can not be determined, -1 is returned.

*Returns* The icon size in bytes, or -1 if the size is unknown.

*Throws* IllegalStateException– if the UPnP device has been removed from the network.

#### 111.16.6.6 **public int getWidth()**

- Returns the width of the icon in pixels. If the actual width of the icon is unknown, -1 is returned.

This method must continue to return the icon width after the UPnP device has been removed from the network.

*Returns* The width in pixels, or -1 if unknown.

### 111.16.7 **public interface UPnPLocalStateVariable extends UPnPStateVariable**

A local UPnP state variable which allows the value of the state variable to be queried.

*Since* 1.1

#### 111.16.7.1 **public Object getCurrentValue()**

- This method will keep the current values of UPnPStateVariables of a UPnPDevice whenever UPnPStateVariable's value is changed , this method must be called.

*Returns* Object current value of UPnPStateVariable. if the current value is initialized with the default value defined UPnP service description.

*Throws* IllegalStateException– if the UPnP state variable has been removed.

### 111.16.8 **public interface UPnPService**

A representation of a UPnP Service. Each UPnP device contains zero or more services. The UPnP description for a service defines actions, their arguments, and event characteristics.

#### 111.16.8.1 **public static final String ID = "UPnP.service.id"**

Property key for the optional service id. The service id property is used when registering UPnP Device services or UPnP Event Listener services. The value of the property contains a String array

(String[]) of service ids. A UPnP Device service can thus announce what service ids it contains. A UPnP Event Listener service can announce for what UPnP service ids it wants notifications. A service id does **not** have to be universally unique. It must be unique only within a device. A null value is a wildcard, matching **all** services. The value is "UPnP.service.id".

#### 111.16.8.2 **public static final String TYPE = "UPnP.service.type"**

Property key for the optional service type uri. The service type property is used when registering UPnP Device services and UPnP Event Listener services. The property contains a String array (String[]) of service types. A UPnP Device service can thus announce what types of services it contains. A UPnP Event Listener service can announce for what type of UPnP services it wants notifications. The service version is encoded in the type string as specified in the UPnP specification. A null value is a wildcard, matching **all** service types. Value is "UPnP.service.type".

*See Also* UPnPService.getType()

#### 111.16.8.3 **public UPnPAction getAction(String name)**

*name* Name of action. Must not contain hyphen or hash characters. Should be < 32 characters.

- Locates a specific action by name. Looks up an action by its name.

*Returns* The requested action or null if no action is found.

*Throws* IllegalStateException– if the UPnP service has been removed from the network.

#### 111.16.8.4 **public UPnPAction[] getActions()**

- Lists all actions provided by this service.

*Returns* Array of actions (UPnPAction[]) or null if no actions are defined for this service.

*Throws* IllegalStateException– if the UPnP service has been removed from the network.

#### 111.16.8.5 **public String getId()**

- Returns the serviceId field in the UPnP service description.

For standard services defined by a UPnP Forum working committee, the serviceId must contain the following components in the indicated order:

- urn:upnp-org:serviceId:
- service ID suffix

Example: urn:upnp-org:serviceId:serviceID.

Note that upnp-org is used instead of schemas-upnp-org in this example because an XML schema is not defined for each serviceId.

For non-standard services specified by UPnP vendors, the serviceId must contain the following components in the indicated order:

- urn:
- ICANN domain name owned by the vendor
- :serviceId:
- service ID suffix

Example: urn:domain-name:serviceId:serviceID.

This method must continue to return the service id after the UPnP service has been removed from the network.

*Returns* The service ID suffix defined by a UPnP Forum working committee or specified by a UPnP vendor. Must be <= 64 characters. Single URI.

**111.16.8.6      public UPnPStateVariable getStateVariable(String name)**

*name* Name of the State Variable

- Gets a UPnPStateVariable objects provided by this service by name

*Returns* State variable or null if no such state variable exists for this service.

*Throws* IllegalStateException– if the UPnP service has been removed from the network.

**111.16.8.7      public UPnPStateVariable[] getStateVariables()**

- Lists all UPnPStateVariable objects provided by this service.

*Returns* Array of state variables or null if none are defined for this service.

*Throws* IllegalStateException– if the UPnP service has been removed from the network.

**111.16.8.8      public String getType()**

- Returns the serviceType field in the UPnP service description.

For standard services defined by a UPnP Forum working committee, the serviceType must contain the following components in the indicated order:

- urn:schemas-upnp-org:service:
- service type suffix:
- integer service version

Example: urn:schemas-upnp-org:service:serviceType:v.

For non-standard services specified by UPnP vendors, the serviceType must contain the following components in the indicated order:

- urn:
- ICANN domain name owned by the vendor
- :service:
- service type suffix:
- integer service version

Example: urn:domain-name:service:serviceType:v.

This method must continue to return the service type after the UPnP service has been removed from the network.

*Returns* The service type suffix defined by a UPnP Forum working committee or specified by a UPnP vendor. Must be <= 64 characters, not including the version suffix and separating colon. Single URI.

**111.16.8.9      public String getVersion()**

- Returns the version suffix encoded in the serviceType field in the UPnP service description.

This method must continue to return the service version after the UPnP service has been removed from the network.

*Returns* The integer service version defined by a UPnP Forum working committee or specified by a UPnP vendor.

**111.16.9      public interface UPnPStateVariable**

The meta-information of a UPnP state variable as declared in the device's service state table (SST).

Method calls to interact with a device (e.g. UPnPAction.invoke(...);) use this class to encapsulate meta information about the input and output arguments.

The actual values of the arguments are passed as Java objects. The mapping of types from UPnP data types to Java data types is described with the field definitions.

- 111.16.9.1**      **public static final String TYPE\_BIN\_BASE64 = "bin.base64"**  
MIME-style Base64 encoded binary BLOB.  
Takes 3 Bytes, splits them into 4 parts, and maps each 6 bit piece to an octet. (3 octets are encoded as 4.) No limit on size.  
Mapped to byte[] object. The Java byte array will hold the decoded content of the BLOB.
- 111.16.9.2**      **public static final String TYPE\_BIN\_HEX = "bin.hex"**  
Hexadecimal digits representing octets.  
Treats each nibble as a hex digit and encodes as a separate Byte. (1 octet is encoded as 2.) No limit on size.  
Mapped to byte[] object. The Java byte array will hold the decoded content of the BLOB.
- 111.16.9.3**      **public static final String TYPE\_BOOLEAN = "boolean"**  
True or false.  
Mapped to Boolean object.
- 111.16.9.4**      **public static final String TYPE\_CHAR = "char"**  
Unicode string.  
One character long.  
Mapped to Character object.
- 111.16.9.5**      **public static final String TYPE\_DATE = "date"**  
A calendar date.  
Date in a subset of ISO 8601 format without time data.  
See <http://www.w3.org/TR/xmlschema-2/#date> [<http://www.w3.org/TR/xmlschema-2/#date>].  
Mapped to java.util.Date object. Always 00:00 hours.
- 111.16.9.6**      **public static final String TYPE\_DATETIME = "dateTime"**  
A specific instant of time.  
Date in ISO 8601 format with optional time but no time zone.  
See <http://www.w3.org/TR/xmlschema-2/#dateTime> [<http://www.w3.org/TR/xmlschema-2/#dateTime>].  
Mapped to java.util.Date object using default time zone.
- 111.16.9.7**      **public static final String TYPE\_DATETIME\_TZ = "dateTime.tz"**  
A specific instant of time.  
Date in ISO 8601 format with optional time and optional time zone.  
See <http://www.w3.org/TR/xmlschema-2/#dateTime> [<http://www.w3.org/TR/xmlschema-2/#dateTime>].  
Mapped to java.util.Date object adjusted to default time zone.

- 111.16.9.8**      **public static final String TYPE\_FIXED\_14\_4 = "fixed.14.4"**  
Same as r8 but no more than 14 digits to the left of the decimal point and no more than 4 to the right.  
Mapped to Double object.
- 111.16.9.9**      **public static final String TYPE\_FLOAT = "float"**  
Floating-point number.  
Mantissa (left of the decimal) and/or exponent may have a leading sign. Mantissa and/or exponent may have leading zeros. Decimal character in mantissa is a period, i.e., whole digits in mantissa separated from fractional digits by period. Mantissa separated from exponent by E. (No currency symbol.) (No grouping of digits in the mantissa, e.g., no commas.)  
Mapped to Float object.
- 111.16.9.10**     **public static final String TYPE\_I1 = "i1"**  
1 Byte int.  
Mapped to Integer object.
- 111.16.9.11**     **public static final String TYPE\_I2 = "i2"**  
2 Byte int.  
Mapped to Integer object.
- 111.16.9.12**     **public static final String TYPE\_I4 = "i4"**  
4 Byte int.  
Must be between -2147483648 and 2147483647  
Mapped to Integer object.
- 111.16.9.13**     **public static final String TYPE\_INT = "int"**  
Integer number.  
Mapped to Integer object.
- 111.16.9.14**     **public static final String TYPE\_NUMBER = "number"**  
Same as r8.  
Mapped to Double object.
- 111.16.9.15**     **public static final String TYPE\_R4 = "r4"**  
4 Byte float.  
Same format as float. Must be between 3.40282347E+38 to 1.17549435E-38.  
Mapped to Float object.
- 111.16.9.16**     **public static final String TYPE\_R8 = "r8"**  
8 Byte float.  
Same format as float. Must be between -1.79769313486232E308 and -4.94065645841247E-324 for negative values, and between 4.94065645841247E-324 and 1.79769313486232E308 for positive values, i.e., IEEE 64-bit (8-Byte) double.  
Mapped to Double object.



- 111.16.9.17**      **public static final String TYPE\_STRING = "string"**  
Unicode string.  
No limit on length.  
Mapped to String object.
- 111.16.9.18**      **public static final String TYPE\_TIME = "time"**  
An instant of time that recurs every day.  
Time in a subset of ISO 8601 format with no date and no time zone.  
See <http://www.w3.org/TR/xmlschema-2/#time> [<http://www.w3.org/TR/xmlschema-2/#dateTime>].  
Mapped to Long. Converted to milliseconds since midnight.
- 111.16.9.19**      **public static final String TYPE\_TIME\_TZ = "time.tz"**  
An instant of time that recurs every day.  
Time in a subset of ISO 8601 format with optional time zone but no date.  
See <http://www.w3.org/TR/xmlschema-2/#time> [<http://www.w3.org/TR/xmlschema-2/#dateTime>].  
Mapped to Long object. Converted to milliseconds since midnight and adjusted to default time zone, wrapping at 0 and 24\*60\*60\*1000.
- 111.16.9.20**      **public static final String TYPE\_UI1 = "ui1"**  
Unsigned 1 Byte int.  
Mapped to an Integer object.
- 111.16.9.21**      **public static final String TYPE\_UI2 = "ui2"**  
Unsigned 2 Byte int.  
Mapped to Integer object.
- 111.16.9.22**      **public static final String TYPE\_UI4 = "ui4"**  
Unsigned 4 Byte int.  
Mapped to Long object.
- 111.16.9.23**      **public static final String TYPE\_URI = "uri"**  
Universal Resource Identifier.  
Mapped to String object.
- 111.16.9.24**      **public static final String TYPE\_UUID = "uuid"**  
Universally Unique ID.  
Hexadecimal digits representing octets. Optional embedded hyphens are ignored.  
Mapped to String object.
- 111.16.9.25**      **public String[] getAllowedValues()**  
□ Returns the allowed values, if defined. Allowed values can be defined only for String types.  
This method must continue to return the state variable allowed values after the UPnP state variable has been removed from the network.  
*Returns* The allowed values or null if not defined. Should be less than 32 characters.

**111.16.9.26 public Object getDefaultValue()**

- Returns the default value, if defined.

This method must continue to return the state variable default value after the UPnP state variable has been removed from the network.

*Returns* The default value or null if not defined. The type of the returned object can be determined by `getJavaDataType`.

**111.16.9.27 public Class getJavaDataType()**

- Returns the Java class associated with the UPnP data type of this state variable.

Mapping between the UPnP data types and Java classes is performed according to the schema mentioned above.

Integer	ui1, ui2, i1, i2, i4, int
Long	ui4, time, time.tz
Float	r4, float
Double	r8, number, fixed.14.4
Character	char
String	string, uri, uuid
Date	date, dateTime, dateTime.tz
Boolean	boolean
byte[]	bin.base64, bin.hex

This method must continue to return the state variable java type after the UPnP state variable has been removed from the network.

*Returns* A class object corresponding to the Java type of this argument.

**111.16.9.28 public Number getMaximum()**

- Returns the maximum value, if defined. Maximum values can only be defined for numeric types.

This method must continue to return the state variable maximum value after the UPnP state variable has been removed from the network.

*Returns* The maximum value or null if not defined.

**111.16.9.29 public Number getMinimum()**

- Returns the minimum value, if defined. Minimum values can only be defined for numeric types.

This method must continue to return the state variable minimum value after the UPnP state variable has been removed from the network.

*Returns* The minimum value or null if not defined.

**111.16.9.30 public String getName()**

- Returns the variable name.
  - All standard variables defined by a UPnP Forum working committee must not begin with X\_ nor A\_.
  - All non-standard variables specified by a UPnP vendor and added to a standard service must begin with X\_.

This method must continue to return the state variable name after the UPnP state variable has been removed from the network.

*Returns* Name of state variable. Must not contain a hyphen character nor a hash character. Should be < 32 characters.

**111.16.9.31 public Number getStep()**

- Returns the size of an increment operation, if defined. Step sizes can be defined only for numeric types.

This method must continue to return the step size after the UPnP state variable has been removed from the network.

*Returns* The increment size or null if not defined.

**111.16.9.32 public String getUPnPDataType()**

- Returns the UPnP type of this state variable. Valid types are defined as constants.

This method must continue to return the state variable UPnP data type after the UPnP state variable has been removed from the network.

*Returns* The UPnP data type of this state variable, as defined in above constants.

**111.16.9.33 public boolean sendsEvents()**

- Tells if this StateVariable can be used as an event source. If the StateVariable is eventable, an event listener service can be registered to be notified when changes to the variable appear.

This method must continue to return the correct value after the UPnP state variable has been removed from the network.

*Returns* true if the StateVariable generates events, false otherwise.

## 111.17 References

- [1] *UPnP Forum*  
<http://www.upnp.org>
- [2] *XML Schema*  
<http://www.w3.org/TR/xmlschema-2>
- [3] *ISO 8601 Date And Time formats*  
<http://www.iso.ch>



# 112 Declarative Services Specification

## Version 1.3

### 112.1 Introduction

The OSGi Framework contains a procedural service model which provides a publish/find/bind model for using *services*. This model is elegant and powerful, it enables the building of applications out of bundles that communicate and collaborate using these services.

This specification addresses some of the complications that arise when the OSGi service model is used for larger systems and wider deployments, such as:

- *Startup Time* - The procedural service model requires a bundle to actively register and acquire its services. This is normally done at startup time, requiring all present bundles to be initialized with a Bundle Activator. In larger systems, this quickly results in unacceptably long startup times.
- *Memory Footprint* - A service registered with the Framework implies that the implementation, and related classes and objects, are loaded in memory. If the service is never used, this memory is unnecessarily occupied. The creation of a class loader may therefore cause significant overhead.
- *Complexity* - Service can come and go at any time. This dynamic behavior makes the service programming model more complex than more traditional models. This complexity negatively influences the adoption of the OSGi service model as well as the robustness and reliability of applications because these applications do not always handle the dynamicity correctly.

The *service component* model uses a declarative model for publishing, finding and binding to OSGi services. This model simplifies the task of authoring OSGi services by performing the work of registering the service and handling service dependencies. This minimizes the amount of code a programmer has to write; it also allows service components to be loaded only when they are needed. As a result, bundles need not provide a BundleActivator class to collaborate with others through the service registry.

From a system perspective, the service component model means reduced startup time and potentially a reduction of the memory footprint. From a programmer's point of view the service component model provides a simplified programming model.

The Service Component model makes use of concepts described in [1] *Automating Service Dependency Management in a Service-Oriented Component Model*.

#### 112.1.1 Essentials

- *Backward Compatibility* - The service component model must operate seamlessly with the existing service model.
- *Size Constraints* - The service component model must not require memory and performance intensive subsystems. The model must also be applicable on resource constrained devices.
- *Delayed Activation* - The service component model must allow delayed activation of a service component. Delayed activation allows for delayed class loading and object creation until needed, thereby reducing the overall memory footprint.
- *Simplicity* - The programming model for using declarative services must be very simple and not require the programmer to learn a complicated API or XML sub-language.

- *Reactive* - It must be possible to react to changes in the external dependencies with different policies.
- *Annotations* - Annotations must be provided that can leverage the type information to create the XML descriptor.
- *Introspection* - It must be possible to introspect the service components.

### 112.1.2

## Entities

- *Service Component* - A service component contains a description that is interpreted at run time to create and dispose objects depending on the availability of other services, the need for such an object, and available configuration data. Such objects can optionally provide a service. This specification also uses the generic term *component* to refer to a service component.
- *Service Component Runtime (SCR)* - The actor that manages the components and their life cycle and allows introspection of the components.
- *Component Description* - The declaration of a service component. It is contained within an XML document in a bundle.
- *Component Properties* - A set of properties which can be specified by the component description, Configuration Admin service and from the component factory.
- *Component Property Type* - A user defined annotation type which defines component properties and is implemented by SCR to provide type safe access to the defined component properties.
- *Component Configuration* - A component configuration represents a component description parameterized by component properties. It is the entity that tracks the component dependencies and manages a component instance. An activated component configuration has a component context.
- *Component Instance* - An instance of the component implementation class. A component instance is created when a component configuration is activated and discarded when the component configuration is deactivated. A component instance is associated with exactly one component configuration.
- *Delayed Component* - A component whose component configurations are activated when their service is requested.
- *Immediate Component* - A component whose component configurations are activated immediately upon becoming satisfied.
- *Factory Component* - A component whose component configurations are created and activated through the component's component factory.
- *Reference* - A specified dependency of a component on a set of target services.
- *Target Services* - The set of services that is defined by the reference interface and target property filter.
- *Bound Services* - The set of target services that are bound to a component configuration.
- *Event methods* - The bind, updated, and unbind methods associated with a Reference.

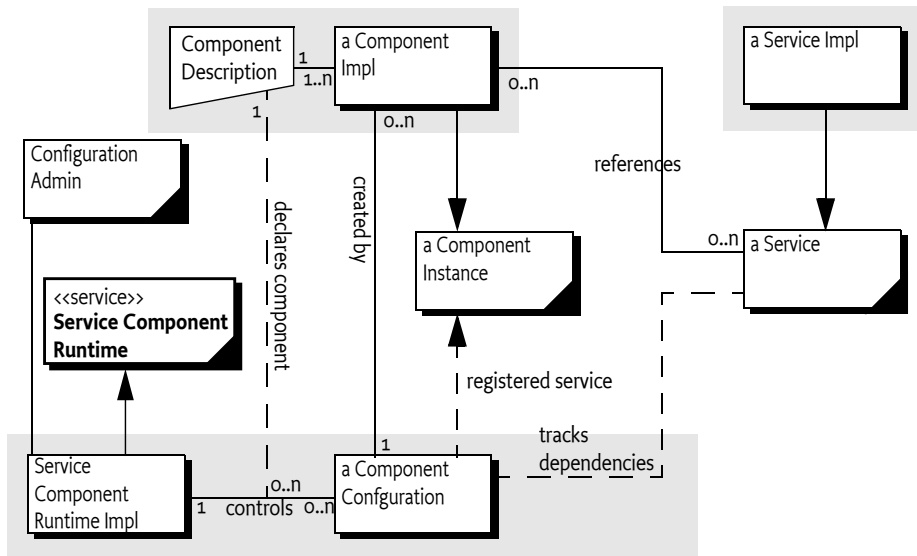
Figure 112.1 *Service Component Runtime, org.osgi.service.component package*

### 112.1.3 Synopsis

The Service Component Runtime reads component descriptions from started bundles. These descriptions are in the form of XML documents which define a set of components for a bundle. A component can refer to a number of services that must be available before a component configuration becomes satisfied. These dependencies are defined in the descriptions and the specific target services can be influenced by configuration information in the Configuration Admin service. After a component configuration becomes satisfied, a number of different scenarios can take place depending on the component type:

- *Immediate Component* - The component configuration of an immediate component must be activated immediately after becoming satisfied. Immediate components may provide a service.
- *Delayed Component* - When a component configuration of a delayed component becomes satisfied, SCR will register the service specified by the service element without activating the component configuration. If this service is requested, SCR must activate the component configuration creating an instance of the component implementation class that will be returned as the service object. If the scope attribute of the service element is bundle, then, for each distinct bundle that requests the service object, a different component configuration is created and activated and a new instance of the component implementation class is returned as the service object. If the scope attribute of the service element is prototype, then, for each distinct request for the service object, such as via ServiceObjects, a different component configuration is created and activated and a new instance of the component implementation class is returned as the service object.
- *Factory Component* - If a component's description specifies the factory attribute of the component element, SCR will register a Component Factory service. This service allows client bundles to create and activate multiple component configurations and dispose of them. If the component's description also specifies a service element, then as each component configuration is activated, SCR will register it as a service.

### 112.1.4 Readers

- *Architects* - The chapter, *Components* on page 292, gives a comprehensive introduction to the capabilities of the component model. It explains the model with a number of examples. The section about *Component Life Cycle* on page 314 provides some deeper insight in the life cycle of components.

- *Service Programmers* - Service programmers should read *Components* on page 292. This chapter should suffice for the most common cases. For the more advanced possibilities, they should consult *Component Description* on page 305 for the details of the XML grammar for component descriptions.
- *Deployers* - Deployers should consult *Deployment* on page 325.

## 112.2 Components

A component is a normal Java class contained within a bundle. The distinguishing aspect of a component is that it is *declared* in an XML document. Component configurations are activated and deactivated under the full control of SCR. SCR bases its decisions on the information in the component's description. This information consists of basic component information like the name and type, optional services that are implemented by the component, and *references*. References are dependencies that the component has on other services.

SCR must *activate* a component configuration when the component is enabled and the component configuration is satisfied and a component configuration is needed. During the life time of a component configuration, SCR can notify the component of changes in its bound references.

SCR will *deactivate* a previously activated component configuration when the component becomes disabled, the component configuration becomes unsatisfied, or the component configuration is no longer needed.

If an activated component configuration's configuration properties change, SCR must either notify the component configuration of the change, if the component description specifies a method to be notified of such changes, or deactivate the component configuration and then attempt to reactivate the component configuration using the new configuration information.

### 112.2.1 Declaring a Component

A component requires the following artifacts in the bundle:

- An XML document that contains the component description.
- The Service-Component manifest header which names the XML documents that contain the component descriptions.
- An implementation class that is specified in the component description.

The elements in the component's description are defined in *Component Description* on page 305. The XML grammar for the component declaration is defined by the XML Schema, see *Component Description Schema* on page 338.

### 112.2.2 Immediate Component

An *immediate component* is activated as soon as its dependencies are satisfied. If an immediate component has no dependencies, it is activated immediately. A component is an immediate component if it is not a factory component and either does not specify a service or specifies a service and the immediate attribute of the component element set to true. If an immediate component configuration is satisfied and specifies a service, SCR must register the component configuration as a service in the service registry and then activate the component configuration.

For example, the bundle entry `/OSGI-INF/activator.xml` contains:

```
<?xml version="1.0" encoding="UTF-8"?>
<scr:component name="example.activator"
  xmlns:scr="http://www.osgi.org/xmlns/scr/v1.3.0">
  <implementation class="com.acme.impl.Activator"/>
</scr:component>
```



```
</scr:component>
```

The manifest header Service-Component must also be specified in the bundle manifest. For example:

```
Service-Component: OSGI-INF/activator.xml
```

An example class for this component could look like:

```
public class Activator {
    public Activator() {...}
    private void activate(BundleContext context) {...}
    private void deactivate() {...}
}
```

This example component is virtually identical to a Bundle Activator. It has no references to other services so it will be satisfied immediately. It publishes no service so SCR will activate a component configuration immediately.

The activate method is called when SCR activates the component configuration and the deactivate method is called when SCR deactivates the component configuration. If the activate method throws an Exception, then the component configuration is not activated and will be discarded.

### 112.2.3 Delayed Component

A *delayed component* specifies a service, is not specified to be a factory component and does not have the immediate attribute of the component element set to true. If a delayed component configuration is satisfied, SCR must register the component configuration as a service in the service registry but the activation of the component configuration is delayed until the registered service is requested. The registered service of a delayed component looks like a normal registered service but does not incur the overhead of an ordinarily registered service that require a service's bundle to be initialized to register the service.

For example, a bundle needs to see events of a specific topic. The Event Admin uses the white board pattern, receiving the events is therefore as simple as registering a Event Handler service. The example XML for the delayed component looks like:

```
<?xml version="1.0" encoding="UTF-8"?>
<scr:component name="example.handler"
    xmlns:scr="http://www.osgi.org/xmlns/scr/v1.3.0">
    <implementation class="com.acme.impl.HandlerImpl"/>
    <property name="event.topics">some/topic</property>
    <service>
        <provide interface="org.osgi.service.event.EventHandler"/>
    </service>
</scr:component>
```

The associated component class looks like:

```
public class HandlerImpl implements EventHandler{
    public void handleEvent(Event evt ) {
        ...
    }
}
```

The component configuration will only be activated once the Event Admin service requires the service because it has an event to deliver on the topic to which the component subscribed.

### 112.2.4 Factory Component

Certain software patterns require the creation of component configurations on demand. For example, a component could represent an application that can be launched multiple times and each application instance can then quit independently. Such a pattern requires a factory that creates the instances. This pattern is supported with a *factory component*. A factory component is used if the factory attribute of the component element is set to a *factory identifier*. This identifier can be used by a bundle to associate the factory with externally defined information.

SCR must register a Component Factory service on behalf of the component as soon as the component factory is satisfied. The service properties must be:

- `component.name` - The name of the component.
- `component.factory` - The factory identifier.

The service properties of the Component Factory service must not include the component properties.

New configurations of the component can be created and activated by calling the `newInstance` method on this Component Factory service. The `newInstance(Dictionary)` method has a Dictionary object as argument. This Dictionary object is merged with the component properties as described in *Component Properties* on page 324. If the component specifies a service, then the service is registered after the created component configuration is satisfied with the component properties. Then the component configuration is activated.

For example, a component can provide a connection to a USB device. Such a connection should normally not be shared and should be created each time such a service is needed. The component description to implement this pattern looks like:

```
<?xml version="1.0" encoding="UTF-8"?>
<scr:component name="example.factory"
  factory="usb.connection"
  xmlns:scr="http://www.osgi.org/xmlns/scr/v1.3.0">
  <implementation class="com.acme.impl.USBConnectionImpl"/>
</scr:component>
```

The component class looks like:

```
public class USBConnectionImpl implements USBConnection {
    private void activate(Map<String, ?> properties) {
        ...
    }
}
```

A factory component can be associated with a service. In that case, such a service is registered for each component configuration. For example, the previous example could provide a USB Connection service.

```
<?xml version="1.0" encoding="UTF-8"?>
<scr:component name="example.factory"
  factory="usb.connection"
  xmlns:scr="http://www.osgi.org/xmlns/scr/v1.3.0">
  <implementation class="com.acme.impl.USBConnectionImpl"/>
  <service>
    <provide interface="com.acme.usb.USBConnection"/>
  </service>
</scr:component>
```

The associated component class looks like:

```
public class USBConnectionImpl implements USBConnection {
    private void activate(Map<String, ?> properties) {...}
    public void connect() { ... }
    ...
    public void close() { ... }
}
```

A new service will be registered each time a new component configuration is created and activated with the `newInstance` method. This allows a bundle other than the one creating the component configuration to utilize the service. If the component configuration is deactivated, the service must be unregistered.

## 112.3 References to Services

Most bundles will require access to other services from the service registry. The dynamics of the service registry require care and attention of the programmer because referenced services, once acquired, could be unregistered at any moment. The component model simplifies the handling of these service dependencies significantly.

The services that are selected by a reference are called the *target services*. These are the services selected by the `BundleContext.getServiceReferences` method where the first argument is the reference's interface and the second argument is the reference's target property, which must be a valid filter.

A component configuration becomes *satisfied* when each specified reference is satisfied. A reference is *satisfied* if it specifies optional cardinality or when the number of target services is equal to or more than the minimum cardinality of the reference. An activated component configuration that becomes *unsatisfied* must be deactivated.

During the activation of a component configuration, SCR must bind some or all of the target services of a reference to the component configuration. Any target service that is bound to the component configuration is called a *bound service*. See *Binding Services* on page 318.

### 112.3.1 Accessing Services

A component instance must be able to use the services that are referenced by the component configuration, that is, the bound services of the references. The following strategies are available for a component instance to acquire these bound services:

- *Event strategy* - SCR calls a method on the component instance when a service becomes bound, when a service becomes unbound, or when its properties are updated. These methods are the `bind`, `updated`, and `unbind` methods specified by the reference. The event strategy is useful if the component needs to be notified of changes to the bound services for a dynamic reference.
- *Field strategy* - SCR modifies a field in the component instance when a service becomes bound, when a service becomes unbound, or when its properties are updated.
- *Lookup strategy* - The component instance can use one of the `locateService` methods of `ComponentContext` to locate a bound service. These methods take the name of the reference as a parameter. If the reference has a dynamic policy, it is important to not store returned service objects but look them up every time they are needed.

A component may use multiple strategies to access the bound services of a reference.

### 112.3.2 Event Methods

When using the event strategy, SCR must callback the component instance at the appropriate time. SCR must callback on the following events:

- `bind` - The `bind` method, if specified, is called to bind a new service to the component that matches the selection criteria. If the policy is dynamic then the `bind` method of a replacement service can be called before its corresponding `unbind` method.
- `updated` - The `updated` method, if specified, is called when the service properties of a bound services are modified and the resulting properties do not cause the service to become unbound because it is no longer selected by the target property.
- `unbind` - The `unbind` method, if specified, is called when SCR needs to unbind the service.

Each event is associated with an *event method*. The prototype of the event methods is:

```
void <method-name>(<arguments>);
```

An event method can take one or more arguments. Each argument must be of one of the following types:

- `<service-type>` - The bound service object.
- `ServiceReference` - A Service Reference for the bound service. This Service Reference may later be passed to the `locateService(String,ServiceReference)` method to obtain the actual service object. This approach is useful when the service properties need to be examined before accessing the service object. It also allows for the delayed activation of bound services when using the event strategy.
- `ComponentServiceObjects` - A Component Service Objects for the bound service. This Component Service Objects can be used to obtain the actual service object or objects. This approach is useful when the referenced service has prototype service scope and the component instance needs multiple service objects for the service.
- `Map` - An unmodifiable Map containing the service properties of the bound service. This Map must additionally implement `Comparable` with the `compareTo` method comparing service property maps using the same ordering as `ServiceReference.compareTo` based upon service ranking and service id.

A suitable method is selected using the following priority:

1. The method takes a single argument and the type of the argument is `org.osgi.framework.ServiceReference`. This method will receive a Service Reference for the bound service.
2. The method takes a single argument and the type of the argument is `ComponentServiceObjects`. This method will receive a Component Service Objects for the bound service.
3. The method takes a single argument and the type of the argument is the type specified by the reference's interface attribute. This method will receive the bound service object.
4. The method takes a single argument and the type of the argument is assignable from the type specified by the reference's interface attribute. If multiple methods match this rule, this implies the method name is overloaded and SCR may choose any of the methods to call. This method will receive the bound service object.
5. The method takes a single argument and the type of the argument is `java.util.Map`. This method will receive an unmodifiable Map containing the service properties of the bound service.
6. The method takes two or more arguments and the types of the arguments must be one of: the type specified by the reference's interface attribute, a type assignable from the type specified by the reference's interface attribute, `org.osgi.framework.ServiceReference`, `ComponentServiceObjects`, or `java.util.Map`. If multiple methods match this rule, this implies the method name is overloaded and SCR may choose any of the methods to call. In the case where the type specified by the reference's interface attribute is `org.osgi.framework.ServiceReference`, `ComponentServiceObjects`, or `java.util.Map`, the first argument of that type will receive the bound service object. If selected event method has more than one argument of that type, the remaining arguments of that type will receive a Service Reference for the bound service, a Service Objects for

the bound service, or an unmodifiable Map containing the service properties of the bound service.

When searching for an event method to call, SCR must locate a suitable method as specified in *Locating Component Methods and Fields* on page 334. If no suitable method is located, SCR must log an error message with the Log Service, if present, and there will be no bind, updated, or unbind notification.

The bind and unbind methods must be called once for each bound service. This implies that if the reference has multiple cardinality, then the methods may be called multiple times. The updated method can be called multiple times per service.

In the following examples, a component requires the Log Service. The first example uses the lookup strategy. The reference is declared without any bind, updated, and unbind methods:

```
<?xml version="1.0" encoding="UTF-8"?>
<scr:component name="example.listen"
  xmlns:scr="http://www.osgi.org/xmlns/scr/v1.3.0">
  <implementation class="com.acme.impl.LogLookupImpl"/>
  <reference name="LOG"
    interface="org.osgi.service.log.LogService"/>
</scr:component>
```

The component implementation class must now lookup the service. This looks like:

```
public class LogLookupImpl {
  private void activate(ComponentContext ctxt) {
    LogService log = (LogService)
      ctxt.locateService("LOG");
    log.log(LogService.LOG_INFO, "Hello Components!");
  }
}
```

Alternatively, the component could use the event strategy and ask to be notified with the Log Service by declaring bind, updated, and unbind methods.

```
<?xml version="1.0" encoding="UTF-8"?>
<scr:component name="example.listen"
  xmlns:scr="http://www.osgi.org/xmlns/scr/v1.3.0">
  <implementation class="com.acme.impl.LogEventImpl"/>
  <reference name="LOG"
    interface="org.osgi.service.log.LogService"
    bind="setLog"
    updated="updatedLog"
    unbind="unsetLog"
  />
</scr:component>
```

The component implementation class looks like:

```
public class LogEventImpl {
  LogService log;
  Integer level;
  void setLog( LogService l, Map<String,?> ref ) {
    log = l;
    updatedLog(ref);
  }
}
```

```

    void updatedLog( LogService l, Map<String,?> ref) {
        level = (Integer) ref.get("level");
    }
    void unsetLog( LogService l ) { log = null; }

    private void activate() {
        log.log(LogService.LOG_INFO, "Hello Components!");
    }
}

```

Event methods can be declared private in the component class but are only looked up in the inheritance chain when they are protected, public, or have default access. See *Locating Component Methods and Fields* on page 334.

### 112.3.3 Field Strategy

When using the field strategy, SCR must modify fields in the component instance at the appropriate time. SCR must modify the fields on the following events:

- bind - The field is modified to bind a new service to the component that matches the selection criteria.
- updated - For certain field types, the field is modified when the service properties of a bound services are modified and the resulting properties do not cause the service to become unbound because it is no longer selected by the target property.
- unbind - The field is modified when SCR needs to unbind the service.

For a reference with unary cardinality, a field must be of one of the following types:

- <service-type> - The bound service object. The type of the field can be the actual service type or it can be a type that is assignable from the actual service type.
- `ServiceReference` - A Service Reference for the bound service. This Service Reference may later be passed to the `locateService(String,ServiceReference)` method to obtain the actual service object. This approach is useful when the service properties need to be examined before accessing the service object. It also allows for the delayed activation of bound services when using field strategy.
- `ComponentServiceObjects` - A Component Service Objects for the bound service. This Component Service Objects can be used to obtain the actual service object or objects. This approach is useful when the referenced service has prototype service scope and the component instance needs multiple service objects for the service.
- `Map` - An unmodifiable Map containing the service properties of the bound service. This Map must additionally implement `Comparable` with the `compareTo` method comparing service property maps using the same ordering as `ServiceReference.compareTo` based upon service ranking and service id.
- `Map.Entry` - An unmodifiable `Map.Entry` whose key is an unmodifiable Map containing the service properties of the bound service, as above, and whose value is the bound service object. This `Map.Entry` must additionally implement `Comparable` with the `compareTo` method comparing the service property map key using the same ordering as `ServiceReference.compareTo` based upon service ranking and service id.

If the actual service type is one of `ServiceReference`, `ComponentServiceObjects`, `Map`, or `Map.Entry`, the field will be set to the service object rather than the object about the service.

For a reference with multiple cardinality, a field must be a collection of one of the following types:

- `Collection`
- `List`

- A subtype of Collection - This type can only be used for dynamic references using the update reference field option. The component instance must initialize the field to a collection object in its constructor.

The type of objects set in the collection are specified by the `field-collection-type` attribute in the component description:

- `service` - The bound service object. This is the default field collection type.
- `reference` - A Service Reference for the bound service.
- `serviceobjects` - A Component Service Objects for the bound service.
- `properties` - An unmodifiable Map containing the service properties of the bound service. This Map must implement `Comparable`, as above.
- `tuple` - An unmodifiable Map.Entry whose key is an unmodifiable Map containing the service properties of the bound service, as above, and whose value is the bound service object. This Map.Entry must implement `Comparable`, as above.

Only instance fields of the field types above are supported. If a referenced field is declared with the static modifier or has a type other than one of the above, SCR must log an error message with the Log Service, if present, and the field must not be modified.

Care must be taken by the component implementation regarding the field. SCR has no way to know if the component implementation itself may alter the field value. The component implementation should not alter the field value and allow SCR to manage it. SCR must treat the field as if the component implementation does not alter the field value so SCR may retain its own copy of the value set in the field.

In the following examples, a component requires the Log Service.

```
<?xml version="1.0" encoding="UTF-8"?>
<scr:component name="example.listen"
  xmlns:scr="http://www.osgi.org/xmlns/scr/v1.3.0">
  <implementation class="com.acme.impl.LogEventImpl"/>
  <reference name="LOG"
    interface="org.osgi.service.log.LogService"
    field="log"
  />
</scr:component>
```

The component implementation class looks like:

```
public class LogEventImpl {
    LogService log;
    private void activate() {
        log.log(LogService.LOG_INFO, "Hello Components!");
    }
}
```

Fields can be declared private in the component class but are only looked up in the inheritance chain when they are protected, public, or have default access. See *Locating Component Methods and Fields* on page 334.

### 112.3.4 Reference Cardinality

A component implementation is always written with a certain *cardinality* for each reference in mind. The cardinality represents two important concepts:

- *Multiplicity* - Does the component implementation assume a single service or does it explicitly handle multiple services? For example, when a component uses the Log Service, it only needs to

bind to one Log Service to function correctly. Alternatively, when the Configuration Admin uses the Configuration Listener services it needs to bind to all target services present in the service registry to dispatch its events correctly.

- *Optionality* - Can the component function without any bound service present? Some components can still perform useful tasks even when no service is available; other components must bind to at least one service before they can be useful. For example, the Configuration Admin in the previous example must still provide its functionality even if there are no Configuration Listener services present. Alternatively, an application that registers a Servlet with the Http Service has little to do when the Http Service is not present, it should therefore use a reference with a mandatory cardinality.

The cardinality is expressed with the following syntax:

```
cardinality ::= optionality '..' multiplicity
optionality ::= '0' | '1'
multiplicity ::= '1' | 'n'
```

The cardinality for a reference can be specified as one of four choices:

- 0..1 - Optional and unary.
- 1..1 - Mandatory and unary (Default).
- 0..n - Optional and multiple.
- 1..n - Mandatory and multiple.

The *minimum cardinality* is specified by the optionality part of the cardinality. This is either 0 or 1. A minimum cardinality property can be used to raise the minimum cardinality of a reference from this initial value. For example, a 0..n cardinality in the component description can be raised into a 3..n cardinality at runtime by setting the minimum cardinality property for the reference to 3. This would typically be done by a deployer setting the minimum cardinality property in a configuration for the component. The minimum cardinality for a unary cardinality cannot exceed 1. See *Minimum Cardinality Property* on page 325 for more information.

A reference is *satisfied* if the number of target services is equal to or more than the minimum cardinality. The multiplicity is irrelevant for the satisfaction of the reference. The multiplicity only specifies if the component implementation is written to handle being bound to multiple services (n) or requires SCR to select and bind to a single service (1).

When a satisfied component configuration is activated, there must be at most one bound service for each reference with a unary cardinality and at least as many bound services as the minimum cardinality for each reference. If the cardinality constraints cannot be maintained after a component configuration is activated, that is the reference becomes unsatisfied, the component configuration must be deactivated. If the reference has a unary cardinality and there is more than one target service for the reference, then the bound service must be the target service with the highest service ranking as specified by the service.ranking property. If there are multiple target services with the same service ranking, then the bound service must be the target service with the highest service ranking and the lowest service id as specified by the service.id property.

In the following example, a component wants to register a resource with all Http Services that are available. Such a scenario has the cardinality of 0..n. The code must be prepared to handle multiple calls to the bind method for each Http Service in such a case. In this example, the code uses the registerResources method to register a directory for external access.

```
<?xml version="1.0" encoding="UTF-8"?>
<scr:component name="example.listen"
  xmlns:scr="http://www.osgi.org/xmlns/scr/v1.3.0">
  <implementation class="com.acme.impl.HttpResourceImpl"/>
  <reference name="HTTP"
    interface="org.osgi.service.http.HttpService"
```



```

        cardinality="0..n"
        bind="setPage"
        unbind="unsetPage"
    />
</scr:component>

public class HttpResourceImpl {
    private void setPage(HttpService http) {
        http.registerResources("/scr", "scr", null );
    }
    private void unsetPage(HttpService http) {
        http.unregister("/scr");
    }
}

```

### 112.3.5 Reference Scope

A component implementation must be written to understand the service scope of referenced services. The *reference scope* defines whether the component expects the bundle to be exposed to a single service object for a bound service or to potentially multiple services objects. The following reference scopes are available:

- *bundle* - For all references to a given bound service, all activated component instances within a bundle must use the same service object. That is, for a given bound service, all component instances within a bundle will be using the same service object. This is the default reference scope.
- *prototype* - For all references to a given bound service, each activated component instance may use a single, distinct service object. That is, for a given bound service, each component instance may use a distinct service object but within a component instance all references to the bound service will use the same service object.
- *prototype required* - For all references to a given bound service, each activated component instance must use a single, distinct service object. That is, for a given bound service, each component instance will use a distinct service object but within a component instance all references to the bound service will use the same service object.

For a bound service of a reference with bundle reference scope, SCR must get the service object from the OSGi Framework's service registry using the `getService` method on the component's Bundle Context. If the service object for a bound service has been obtained and the service becomes unbound, SCR must `ungetService` the service object using the `ungetService` method on the component's Bundle Context and discard all references to the service object. This ensures that the bundle will only be exposed to a single instance of the service object at any given time.

For a bound service of a reference with prototype or prototype required reference scope, SCR must use a Service Objects object obtained from the OSGi Framework's service registry using the component's Bundle Context to get any service objects. If service objects for a bound service have been obtained and the service becomes unbound, SCR must `ungetService` any unreleased service objects using the Service Objects object obtained from the OSGi Framework's service registry using the component's Bundle Context. This means that if a component instance used a Component Service Objects object to obtain service objects, SCR must track those service objects so that when the service becomes unbound, SCR can `ungetService` any unreleased service objects.

Additionally, for a bound service of a reference with prototype required reference scope, only services registered with prototype service scope can be considered as target services. This ensures that each component instance can be exposed to a single, distinct instance of the service object. Using prototype required reference scope effectively adds `service.scope=prototype` to the target property for the reference. A service that does not use prototype service scope cannot be used as a bound service for a reference with prototype required reference scope since the service cannot provide a distinct service object for each component instance.

### 112.3.6 Reference Policy

Once all the references of a component are satisfied, a component configuration can be activated and therefore bound to target services. However, the dynamic nature of the OSGi service registry makes it likely that services are registered, modified and unregistered after target services are bound. These changes in the service registry could make one or more bound services no longer a target service thereby making obsolete any object references that the component has to these service objects. Components therefore must specify a *policy* how to handle these changes in the set of bound services. A *policy-option* can further refine how changes affect bound services.

#### 112.3.6.1 Static Reference Policy

The *static policy* is the most simple policy and is the default policy. A reference with a static policy is called a *static reference*. A component instance never sees any of the dynamics of the static reference. The bind method is called and/or the field is set before the component instance is activated. Component configurations are deactivated before any bound service for the static reference becomes unavailable. If a target service is available to replace the bound service which became unavailable, the component configuration must be reactivated and the replacement service is bound to the new component instance.

If the policy-option is reluctant then the registration of an additional target service for a reference must not result in deactivating and reactivating a component configuration. If the policy-option is greedy then the component configuration must be reactivated when new applicable services become available. See Table 112.1 on page 303.

If a static reference specifies an updated method and the bound service's properties change, SCR must call the updated method.

The static policy can be very expensive if it depends on services that frequently unregister and re-register or if the cost of activating and deactivating a component configuration is high. Static policy is usually also not applicable if the cardinality specifies multiple bound services.

#### 112.3.6.2 Dynamic Reference Policy

The *dynamic policy* is slightly more complex since the component implementation must properly handle changes in the set of bound services that can occur on any thread at any time after the component instance is created. A reference with a dynamic policy is called a *dynamic reference*. With the dynamic policy, SCR can change the set of bound services without deactivating a component configuration. If the component uses the event strategy to access services, then the component instance will be notified of changes in the set of bound services by calls to the bind, updated, and unbind methods.

If the policy-option is reluctant then a bound reference is not rebound even if a more suitable service becomes available for a 1..1 or 0..1 reference. If the policy-option is greedy then the component must be unbound and rebound for that reference. See Table 112.1 on page 303.

The previous example with the registering of a resource directory used a static policy. This implied that the component configurations are deactivated when there is a change in the bound set of Http Services. The code in the example can be seen to easily handle the dynamics of Http Services that come and go. The component description can therefore be updated to:

```
<?xml version="1.0" encoding="UTF-8"?>
<scr:component name="example.listen"
  xmlns:scr="http://www.osgi.org/xmlns/scr/v1.3.0">
  <implementation class="com.acme.impl.HttpResourceImpl"/>
  <reference name="HTTP"
    interface="org.osgi.service.http.HttpService"
    cardinality="0..n"
    policy="dynamic"
    bind="setPage"/>
```

```

        unbind="unsetPage"
    />
</scr:component>

```

The code is identical to the previous example.

### 112.3.7 Reference Policy Option

The reference policy option defines how eager the reference is to rebind when a new, potentially a higher ranking, target service becomes available. The reference policy option can have the following values:

- **reluctant** - Minimize rebinding and reactivating. This is the default reference policy option.
- **greedy** - Maximize the use of the best service by deactivating static references or rebinding dynamic references.

Table 112.1 defines the actions that are taken when a *better* target service becomes available. In this context, better is when the reference is not bound or when the new target service has a higher ranking than the bound service.

Table 112.1 Action taken for policy-option when a new or higher ranking service becomes available

Cardinality	static reluctant	static greedy	dynamic reluctant	dynamic greedy
0..1	Ignore	Reactivate to bind the better target service.	If no service is bound, bind to new target service. Otherwise, ignore new target service.	If no service is bound, bind to better target service. Otherwise, unbind the bound service and bind the better target service.
1..1	Ignore	Reactivate to bind the better target service.	Ignore	Unbind the bound service, then bind the new service.
0..n	Ignore	Reactivate	Bind new target service	Bind new target service
1..n	Ignore	Reactivate	Bind new target service	Bind new target service

### 112.3.8 Reference Field Option

For a reference using field strategy, the reference field option defines how SCR must manage the field value. The reference field option can have the following values:

- **replace** - SCR must set the field value. Any field value set by the constructor of the component instance is overwritten. This is the default reference field option.
- **update** - SCR must update the collection set in the field. This collection can be set by the constructor of the component instance. This reference field option can only be used for a dynamic reference with multiple cardinality.

For a static reference, the replace option must be used.

For a dynamic reference, the choice of reference field option is influenced by the cardinality of the reference. For unary cardinality, the replace option must be used. For multiple cardinality, either the replace or update option can be used.

If the update option is used when not permitted, SCR must log an error message with the Log Service, if present, and the field must not be modified.

#### 112.3.8.1 Replace Field Option

If the field is declared with the `final` modifier, SCR must log an error message with the Log Service, if present, and the field must not be modified.

For a static reference, SCR must set the value of the field before the component instance is activated and must not change the field while the component is active. This means there is a *happens-before* relationship between setting the field and activating the component instance, so the active component can safely read the field.

For a dynamic reference, the field must be declared with the volatile modifier so that field value changes made by SCR are visible to other threads. If the field is not declared with the volatile modifier, SCR must log an error message with the Log Service, if present, and the field must not be modified.

For a dynamic reference with unary cardinality, SCR must set the field with initial bound service, if any, before the component instance is activated. When there is a new bound service or the service properties of the bound service are modified and the field holds service properties, SCR must replace the field value. If the reference has optional cardinality and there is no bound service, SCR must set the field value to null.

For a dynamic reference with multiple cardinality, the type of the field must be Collection or List. If the field has a different type, SCR must log an error message with the Log Service, if present, and the field must not be modified. Before the component instance is activated, SCR must set the field with a new mutable collection that must contain the initial set of bound services sorted using the same ordering as `ServiceReference.compareTo` based upon service ranking and service id. The new collection may be empty if the reference has optional cardinality and there are no bound services. When there is a change in the set of bound services or the service properties of a bound service are modified and the collection holds service properties, SCR must replace the field value with a new mutable collection that must contain the updated set of bound services sorted using the same ordering as `ServiceReference.compareTo` based upon service ranking and service id. The new collection may be empty if the reference has optional cardinality and there are no bound services.

### 112.3.8.2

#### Update Field Option

The update option can only be used for a dynamic reference with multiple cardinality. The component's constructor can set the field with its choice of collection implementation. In this case, the field can be declared with the `final` modifier. The collection implementation used by the component should use identity rather than equals or hashCode to manage the elements of the collection. The collection implementation should also be thread-safe since SCR may update the collection from threads different than those used by the component instance.

After constructing the component instance, if the field value is null:

- If the type of the field is Collection or List, SCR will set the field to a new mutable empty collection or list object, respectively. If the field is declared with the `final` modifier, SCR must log an error message with the Log Service, if present, and the field must not be modified.
- Otherwise, SCR must log an error message with the Log Service, if present, and the field must not be modified.

SCR must not change the field value while the component is active and only update the contents of the collection. SCR must update the collection before the component instance is activated by calling `Collection.add` for each bound service. When there is a change to the set of bound services:

- SCR must call `Collection.add` for a newly bound service.
- SCR must call `Collection.remove` for an unbound service.
- If the service properties of a bound service are modified and the collection holds service properties, SCR must call `Collection.add` for the replacement element followed by `Collection.remove` for the old element.

The collection may be empty if the reference has optional cardinality and there are no bound services.

### 112.3.9 Selecting Target Services

The target services for a reference are constrained by the reference's interface name and target property. By specifying a filter in the target property, the programmer and deployer can constrain the set of services that should be part of the target services.

For example, a component wants to track all Component Factory services that have a factory identification of `acme.application`. The following component description shows how this can be done.

```
<?xml version="1.0" encoding="UTF-8"?>
<scr:component name="example.listen"
  xmlns:scr="http://www.osgi.org/xmlns/scr/v1.3.0">
  <implementation class="com.acme.impl.FactoryTracker"/>
  <reference name="FACTORY"
    interface=
      "org.osgi.service.component.ComponentFactory"
    target="(component.factory=acme.application)"
  />
</scr:component>
```

The filter is manifested as a component property called the *target property*. The target property can also be set by property and properties elements, see *Property and Properties Elements* on page 309. The deployer can also set the target property by establishing a configuration for the component which sets the value of the target property. This allows the deployer to override the target property in the component description. See *Target Property* on page 325 for more information.

### 112.3.10 Circular References

It is possible for a set of component descriptions to create a circular dependency. For example, if component A references a service provided by component B and component B references a service provided by component A then a component configuration of one component cannot be satisfied without accessing a partially activated component instance of the other component. SCR must ensure that a component instance is never accessible to another component instance or as a service until it has been fully activated, that is it has returned from its activate method if it has one.

Circular references must be detected by SCR when it attempts to satisfy component configurations and SCR must fail to satisfy the references involved in the cycle and log an error message with the Log Service, if present. However, if one of the references in the cycle has optional cardinality SCR must break the cycle. The reference with the optional cardinality can be satisfied and bound to zero target services. Therefore the cycle is broken and the other references may be satisfied.

## 112.4 Component Description

Component descriptions are defined in XML documents contained in a bundle and any attached fragments.

If SCR detects an error when processing a component description, it must log an error message with the Log Service, if present, and ignore the component description. Errors can include XML parsing errors and ill-formed component descriptions.

### 112.4.1 Annotations

A number of CLASS retention annotations have been provided to allow tools to construct the component description XML from the Java class files. These annotations will be discussed with the appropriate elements and attributes. Since the naming rules between XML and Java differ, some name changes are necessary.

Multi-word element and attribute names that use a minus sign ('-' \u002D) are changed to camel case. For example, the configuration-pid attribute in the component element is the configurationPid member in the @Component annotation. The annotation class that corresponds to an element starts with an upper case letter. For example the component element is represented by the @Component annotation.

Some elements do not have a corresponding annotation since the annotations can be parameterized by the type information in the Java class. For example, the @Component annotation synthesizes the implement element's class attribute from the type it is applied to.

See *Component Annotations* on page 328 for more information.

### 112.4.2 Service Component Header

XML documents containing component descriptions must be specified by the Service-Component header in the manifest. The value of the header is a comma separated list of paths to XML entries within the bundle.

```
Service-Component ::= header // See Common Header Syntax in Core
```

The Service-Component header has no architected directives or properties. The header can be left empty.

The last component of each path in the Service-Component header may use wildcards so that Bundle.findEntries can be used to locate the XML document within the bundle and its fragments. For example:

```
Service-Component: OSGI-INF/*.xml
```

A Service-Component manifest header specified in a fragment is ignored by SCR. However, XML documents referenced by a bundle's Service-Component manifest header may be contained in attached fragments.

SCR must process each XML document specified in this header. If an XML document specified by the header cannot be located in the bundle and its attached fragments, SCR must log an error message with the Log Service, if present, and continue.

### 112.4.3 XML Document

A component description must be in a well-formed XML document, [4] *Extensible Markup Language (XML) 1.0*, stored in a UTF-8 encoded bundle entry. The namespace for component descriptions is:

```
http://www.osgi.org/xmlns/scr/v1.3.0
```

The recommended prefix for this namespace is scr. This prefix is used by examples in this specification. XML documents containing component descriptions may contain a single, root component element or one or more component elements embedded in a larger document. Use of the namespace for component descriptions is mandatory. The attributes and sub-elements of a component element are always unqualified.

If an XML document contains a single, root component element which does not specify a namespace, then the http://www.osgi.org/xmlns/scr/v1.0.0 namespace is assumed. Component descriptions using the http://www.osgi.org/xmlns/scr/v1.0.0 namespace must be treated according to version 1.0 of this specification.

SCR must parse all component elements in the namespace. Elements not in this namespace must be ignored. Ignoring elements that are not recognized allows component descriptions to be embedded in any XML document. For example, an entry can provide additional information about components. These additional elements are parsed by another sub-system.

See *Component Description Schema* on page 338 for component description schema.

### 112.4.4 Component Element

The component element specifies the component description. The following text defines the structure of the XML grammar using a form that is similar to the normal grammar used in OSGi specifications. In this case the grammar should be mapped to XML elements:

```
<component> ::= (<property> | <properties>)*
                <service>?
                <reference>*
                <implementation>
```

SCR must not require component descriptions to specify the elements in the order listed above and as required by the XML schema. SCR must allow other orderings since arbitrary orderings of these elements do not affect the meaning of the component description. Only the relative ordering of property and properties elements and of reference elements have meaning.

The component element has the attributes and @Component annotations defined in the following table.

Table 112.2 Component Element and Annotations

Attribute	Annotation	Description
name	<a href="#">name</a>	The <i>name</i> of a component must be unique within a bundle. The component name is used as a PID to retrieve component properties from the OSGi Configuration Admin service if present, unless a configuration-pid attribute has been defined. See <i>Deployment</i> on page 325 for more information. If the component name is used as a PID then it should be unique within the framework. The XML schema allows the use of component names which are not valid PIDs. Care must be taken to use a valid PID for a component name if the component should be configured by the Configuration Admin service. This attribute is optional. The default value of this attribute is the value of the class attribute of the nested implementation element. If multiple component elements in a bundle use the same value for the class attribute of their nested implementation element, then using the default value for this attribute will result in duplicate component names. In this case, this attribute must be specified with a unique value.
enabled	<a href="#">enabled</a>	Controls whether the component is <i>enabled</i> when the bundle is started. The default value is true. If enabled is set to false, the component is disabled until the method enableComponent is called on the ComponentContext object. This allows some initialization to be performed by some other component in the bundle before this component can become satisfied. See <i>Enabled</i> on page 314.
factory	<a href="#">factory</a>	If set to a non-empty string, it indicates that this component is a <i>factory component</i> . SCR must register a Component Factory service for each factory component. See <i>Factory Component</i> on page 294.
immediate	<a href="#">immediate</a>	Controls whether component configurations must be immediately activated after becoming satisfied or whether activation should be delayed. The default value is false if the factory attribute or if the service element is specified and true otherwise. If this attribute is specified, its value must be false if the factory attribute is also specified or must be true unless the service element is also specified.

Attribute	Annotation	Description
configuration-policy	<a href="#">configurationPolicy</a> OPTIONAL REQUIRE IGNORE	<p>Controls whether component configurations must be satisfied depending on the presence of a corresponding Configuration object in the OSGi Configuration Admin service. A corresponding configuration is a Configuration object where the PID is the name of the component.</p> <ul style="list-style-type: none"> <li>optional - (default) Use the corresponding Configuration object if present but allow the component to be satisfied even if the corresponding Configuration object is not present.</li> <li>require - There must be a corresponding Configuration object for the component configuration to become satisfied.</li> <li>ignore - Always allow the component configuration to be satisfied and do not use the corresponding Configuration object even if it is present.</li> </ul>
configuration-pid	<a href="#">configurationPid</a>	<p>The configuration PIDs to be used for the component in conjunction with Configuration Admin. Multiple configuration PIDs can be specified by using a whitespace separated list in the attribute. The default value for this attribute is the name of the component.</p> <p>The annotation uses a <code>String[]</code> to specify multiple configuration PIDs. The order in which configuration PIDs are specified must be preserved in the generated component description. The annotation can also use the special configuration PID name "\$" to specify the name of the component. This special name must be replaced with the actual name of the component in the generated component description.</p>
activate	<a href="#">Activate</a>	<p>Specifies the name of the method to call when a component configuration is activated. The default value of this attribute is <code>activate</code>. See <i>Activate Method</i> on page 318 for more information.</p> <p>The annotation must be applied to the <code>activate</code> method and can only be used once.</p>
deactivate	<a href="#">Deactivate</a>	<p>Specifies the name of the method to call when a component configuration is deactivated. The default value of this attribute is <code>deactivate</code>. See <i>Deactivate Method</i> on page 321 for more information.</p> <p>The annotation must be applied to the <code>deactivate</code> method and can only be used once.</p>
modified	<a href="#">Modified</a>	<p>Specifies the name of the method to call when the configuration properties for a component configuration is using a Configuration object from the Configuration Admin service and that Configuration object is modified without causing the component configuration to become unsatisfied. If this attribute is not specified, then the component configuration will become unsatisfied if its configuration properties use a Configuration object that is modified in any way. See <i>Modified Method</i> on page 320 for more information.</p> <p>The annotation must be applied to the <code>modified</code> method and can only be used once.</p>

### 112.4.5 Implementation Element

The implementation element is required and defines the name of the component implementation class. The single attribute is defined in the following table.



Table 112.3 *Implementation Element and Annotations*

Attribute	Annotation	Description
class	<a href="#">Component</a>	The Java fully qualified name of the implementation class.  The component <a href="#">Component</a> annotation will define the implementation element automatically from the type it is applied to.

The class is retrieved with the `loadClass` method of the component's bundle. The class must be public and have a public constructor without arguments (this is normally the default constructor) so component instances may be created by SCR with the `newInstance` method on `Class`.

If the component description specifies a service, the class must implement all interfaces that are provided by the service.

## 112.4.6 Property and Properties Elements

A component description can define a number of properties. These can be defined inline or from a resource in the bundle. The property and properties elements can occur multiple times and they can be interleaved. This interleaving is relevant because the properties are processed from top to bottom. Later properties override earlier properties that have the same name.

Properties can also be overridden by a Configuration Admin service's Configuration object before they are exposed to the component or used as service properties. This is described in *Component Properties* on page 324 and *Deployment* on page 325.

The property element has the attributes and annotations defined in the following table.

Table 112.4 *Property Element and Annotations*

Attribute	Annotation	Description
name	<a href="#">Component property</a>	The name of the property.
value		The value of the property. This value is parsed according to the property type. If the value attribute is specified, the body of the element is ignored. If the type of the property is not <code>String</code> , parsing of the value is done by the static <code>valueOf(String)</code> method in the given type. For <code>Character</code> types, the conversion must be handled by <code>Integer.valueOf</code> method, a <code>Character</code> is always represented by its Unicode value.
type		The type of the property. Defines how to interpret the value. The type must be one of the following Java types: <ul style="list-style-type: none"> <li>• <code>String</code> (default)</li> <li>• <code>Long</code></li> <li>• <code>Double</code></li> <li>• <code>Float</code></li> <li>• <code>Integer</code></li> <li>• <code>Byte</code></li> <li>• <code>Character</code></li> <li>• <code>Boolean</code></li> <li>• <code>Short</code></li> </ul>

Attribute	Annotation	Description
<body>		<p>If the value attribute is not specified, the body of the property element must contain one or more values. The value of the property is then an array of the specified type. Except for String objects, the result will be translated to an array of primitive types. For example, if the type attribute specifies Integer, then the resulting array must be int[].</p> <p>Values must be placed one per line and blank lines are ignored. Parsing of the value is done by the parse methods in the class identified by the type, after trimming the line of any beginning and ending white space. String values are also trimmed of beginning and ending white space before being placed in the array.</p>

For example, a component that needs an array of hosts can use the following property definition:

```
<property name="hosts">
    www.acme.com
    backup.acme.com
</property>
```

This property declaration results in the property hosts, with a value of String[] { "www.acme.com", "backup.acme.com" }.

A property can also be set with the [property](#) annotation element of Component. This element is an array of strings that must follow the following syntax:

```
property ::= name ( ':' type )? '=' value
```

In this case name, type, and value parts map to the attributes of the property element. If multiple values must be specified then the same name can be repeated multiple times. For example:

```
@Component(property={"foo: Integer=1", "foo: Integer=2", "foo: Integer=3"})
public class FooImpl {
    ...
}
```

The properties element references an entry in the bundle whose contents conform to a standard [3] *Java Properties File*.

At runtime, SCR reads the entry to obtain the properties and their values. The properties element attributes are defined in the following table.

Table 112.5 *Properties Element and Annotations*

Attribute	Annotation	Description
entry	<a href="#">Component properties</a>	The entry path relative to the root of the bundle

For example, to include vendor identification properties that are stored in the OSGI-INF directory, the following definition could be used:

```
<properties entry="OSGI-INF/vendor.properties"/>
```

The [Component properties](#) element can be used to provide the same information, this element consists of an array of strings where each string defines an entry. The order within the array is the order that must be used for the XML. However, the annotations do not support interleaving of the generated property and properties elements.

For example:

```
@Component(properties="OSGI-INF/vendor.properties")
```

See *Ordering of Generated Properties* on page 332 for more information on the ordering of generated properties when using annotations.

### 112.4.7 Service Element

The service element is optional. It describes the service information to be used when a component configuration is to be registered as a service.

A service element has the following attribute defined in the following table.

Table 112.6 *Service Element and Annotations*

Attribute	Annotation	Description
scope	<b>Component scope</b> SINGLETON BUNDLE PROTOTYPE	Controls the scope of the provided service. If set to singleton, when the component is registered as a service, it must be registered as a bundle scope service but only a single component configuration must be created and activated and a new instance of the component implementation class of the component must be used for all bundles using the service. If set to bundle, when the component is registered as a service, it must be registered as a bundle scope service and a different component configuration is created and activated and a new instance of the component implementation class must be created for each bundle using the service. If set to prototype, when the component is registered as a service, it must be registered as a prototype scope service and a different component configuration is created and activated and a new instance of the component implementation class must be created for each distinct request for the service, such as via ServiceObjects.

The scope attribute must be singleton if the component is a factory component or an immediate component. This is because SCR is not free to create component configurations as necessary to support non-singleton scoped services. A component description is ill-formed if it specifies that the component is a factory component or an immediate component and scope is not singleton.

The service element must have one or more provide elements that define the service interfaces. The provide element has the attribute defined in the following table.

Table 112.7 *Provide Element and Annotations*

Attribute	Annotation	Description
interface	<b>Component service</b>	The name of the interface that this service is registered under. This name must be the fully qualified name of a Java class. For example, <code>org.osgi.service.log.LogService</code> . The specified Java class should be an interface rather than a class, however specifying a class is supported. The component implementation class must implement all the specified service interfaces.  The Component annotation can specify the provided services, if this element is not specified all directly implemented interfaces on the component's type are defined as service interfaces. Specifying an empty array indicates that no service should be registered.

For example, a component implements an Event Handler service.

```
<service>
  <provide interface=
    "org.osgi.service.eventadmin.EventHandler" />
</service>
```

This previous example can be generated with the following annotation:

```
@Component
public class Foo implements EventHandler { ... }
```

## 112.4.8 Reference Element

A *reference* declares a dependency that a component has on a set of target services. A component configuration is not satisfied, unless all its references are satisfied. A reference specifies target services by specifying their interface and an optional target property.

A reference element has the attributes defined in the following table.

Table 112.8 Reference Element and Annotations

Attribute name	Annotation name	Description
		The name of the reference. This name is local to the component and can be used to locate a bound service of this reference with one of the locateService methods of <a href="#">ComponentContext</a> . Each reference element within the component must have a unique name. This name attribute is optional. The default value of this attribute is the value of the interface attribute of this element. If multiple reference elements in the component use the same interface name, then using the default value for this attribute will result in duplicate reference names. In this case, this attribute must be specified with a unique name for the reference to avoid an error.
interface	service	The Reference annotation will use the name of the annotated method or field as the default reference name. If the method name begins with bind, set or add, that prefix is removed. Fully qualified name of the class that is used by the component to access the service. The service provided to the component must be type compatible with this class. That is, the component must be able to cast the service object to this class. A service must be registered under this name to be considered for the set of target services.
cardinality	cardinality MANDATORY OPTIONAL MULTIPLE AT_LEAST_ONE	The Reference annotation will use the type of the first argument of the annotated method or the type of the annotated field to determine the service value. Specifies if the reference is optional and if the component implementation support a single bound service or multiple bound services. See <i>Reference Cardinality</i> on page 299.
policy	policy STATIC DYNAMIC	The policy declares the assumption of the component about dynamicity. See <i>Reference Policy</i> on page 302.
policy-option	policyOption RELUCTANT GREEDY	Defines the policy when a better service becomes available. See <i>Reference Policy</i> on page 302.
target	target	An optional OSGi Framework filter expression that further constrains the set of target services. The default is no filter, limiting the set of matched services to all service registered under the given reference interface. The value of this attribute is used for the value of the target property of the reference. See <i>Target Property</i> on page 325.

Attribute	Annotation	Description
scope	<a href="#">scope</a> <a href="#">BUNDLE</a> <a href="#">PROTOTYPE</a> <a href="#">PROTOTYPE_</a> <a href="#">REQUIRED</a>	The reference scope for this reference. See <i>Reference Scope</i> on page 301.
bind	<a href="#">Reference</a> <a href="#">bind</a>	The name of a method in the component implementation class that is used to notify that a service is bound to the component configuration. For static references, this method is only called before the activate method. For dynamic references, this method can also be called while the component configuration is active. See <i>Accessing Services</i> on page 295.  The Reference annotation will use the name of the method it is applied to as the bind method name.
updated	<a href="#">updated</a>	The name of a method in the component implementation class that is used to notify that a bound service has modified its properties.
unbind	<a href="#">unbind</a>	Same as bind, but is used to notify the component configuration that the service is unbound. For static references, the method is only called after the deactivate method. For dynamic references, this method can also be called while the component configuration is active. See <i>Accessing Services</i> on page 295.
field	<a href="#">Reference</a> <a href="#">field</a>	The name of a field in the component implementation class that is used to hold service(s) that are bound to the component configuration. For static references, this field is only set before the activate method. For dynamic references, this field can be modified while the component configuration is active. See <i>Accessing Services</i> on page 295.  The Reference annotation will use the name of the field it is applied to as the field name.
field-option	<a href="#">fieldOption</a> <a href="#">REPLACE</a> <a href="#">UPDATE</a>	Defines how the field value must be managed. This is ignored if the field attribute is not set. See <i>Reference Field Option</i> on page 303.
field-collection-type		Defines the types of elements in the collection referenced by the field value. This is ignored if the field attribute is not set or the cardinality is unary. See <i>Field Strategy</i> on page 298 for more information.  The Reference annotation can infer the value of the collection elements from the generic type information of the annotated field.

In the generated component description, the reference elements must be ordered in ascending lexicographical order, using `String.compareTo`, of the [names](#) of the references.

The following code demonstrates the use of the [Reference](#) annotation for the event strategy.

```
@Component
public class FooImpl implements Foo {
    @Reference(
        policy = DYNAMIC,
        policyOption = GREEDY,
        cardinality = MANDATORY )
    void setLog( LogService log ) { ... }
    void unsetLog( LogService log ) { ... }
    void updatedLog( Map<String,?> ref ) { ... }

    @Activate
```

```

    void open() { ... }
    @Deactivate
    void close() { ... }
}

```

The following code demonstrates the use of the [Reference](#) annotation for the field strategy.

```

@Component
public class FooImpl implements Foo {
    @Reference(
        policy = DYNAMIC,
        policyOption = GREEDY,
        cardinality = MANDATORY )
    volatile LogService log;

    @Activate
    void open() { log.log(LOG_INFO, "activated"); }
    @Deactivate
    void close() { log.log(LOG_INFO, "deactivated"); }
}

```

For a reference to be used with the lookup strategy, there are no bind methods or fields to annotate with the [Reference](#) annotation. Instead [Reference](#) annotations can be specified in the [reference](#) element of the [Component](#) annotation. When used in this way, the [name](#) and [service](#) elements must be specified since there is no annotated member from which the name or service can be determined. The following code demonstrates the use of the [Reference](#) annotation for the lookup strategy.

```

@Component( reference =
    @Reference( name = "log", service = LogService.class )
)
public class FooImpl implements Foo {
    @Activate
    void open( ComponentContext context ) {
        LogService log = (LogService) context.locateService( "log" );
        ...
    }
    @Deactivate
    void close() { ... }
}

```

## 112.5 Component Life Cycle

### 112.5.1 Enabled

A component must first be *enabled* before it can be used. A component cannot be enabled unless the component's bundle is started. See *Starting Bundles* in *OSGi Core Release 6*. All components in a bundle become disabled when the bundle is stopped. So the life cycle of a component is contained within the life cycle of its bundle.

Every component can be enabled or disabled. The initial enabled state of a component is specified in the component description via the `enabled` attribute of the component element. See *Component Element* on page 307. Component configurations can be created, satisfied and activated only when the component is enabled.

The enabled state of a component can be controlled with the Component Context [enableComponent\(String\)](#) and [disableComponent\(String\)](#) methods. The purpose of later enabling

a component is to be able to decide programmatically when a component can become enabled. For example, an immediate component can perform some initialization work before other components in the bundle are enabled. The component descriptions of all other components in the bundle can be disabled by having `enabled` set to `false` in their component descriptions. After any necessary initialization work is complete, the immediate component can call `enableComponent` to enable the remaining components.

The `enableComponent` and `disableComponent` methods must return after changing the enabled state of the named component. Any actions that result from this, such as activating or deactivating a component configuration, must occur asynchronously to the method call. Therefore a component can disable itself.

All components in a bundle can be enabled by passing a null as the argument to `enableComponent`.

### 112.5.2 Satisfied

Component configurations can only be activated when the component configuration is *satisfied*. A component configuration becomes satisfied when the following conditions are all satisfied:

- The component is *enabled*.
- If the component description specifies `configuration-policy=required`, then a Configuration object for the component is present in the Configuration Admin service.
- Using the component properties of the component configuration, all the component's references are satisfied. A reference is satisfied when the reference specifies optional cardinality or the number of target services is equal to or more than the minimum cardinality of the reference.

Once any of the listed conditions are no longer true, the component configuration becomes *unsatisfied*. An activated component configuration that becomes unsatisfied must be deactivated.

### 112.5.3 Immediate Component

A component is an immediate component when it must be activated as soon as its dependencies are satisfied. Once the component configuration becomes unsatisfied, the component configuration must be deactivated. If an immediate component configuration is satisfied and specifies a service, SCR must register the component configuration as a service in the service registry and then activate the component configuration. The service properties for this registration consist of the component properties as defined in *Service Properties* on page 324.

The state diagram is shown in Figure 112.2.

Figure 112.2 Immediate Component Configuration

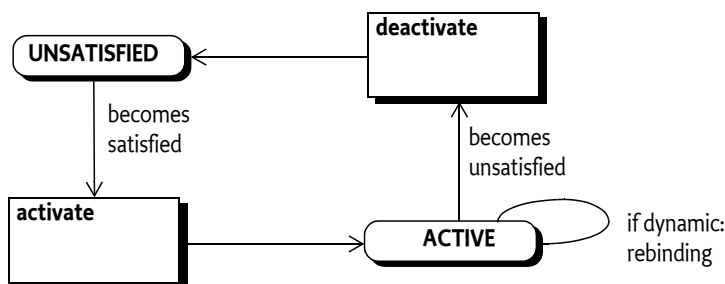

### 112.5.4 Delayed Component

A key attribute of a delayed component is the delaying of class loading and object creation. Therefore, the activation of a delayed component configuration does not occur until there is an actual request for a service object. A component is a delayed component when it specifies a service but it is

not a factory component and does not have the immediate attribute of the component element set to true.

SCR must register a service after the component configuration becomes satisfied. The registration of this service must look to observers of the service registry as if the component's bundle actually registered this service. This strategy makes it possible to register services without creating a class loader for the bundle and loading classes, thereby allowing reduction in initialization time and a delay in memory footprint.

When SCR registers the service on behalf of a component configuration, it must avoid causing a class load to occur from the component's bundle. SCR can ensure this by registering a ServiceFactory object with the Framework for that service. By registering a ServiceFactory object, the actual service object is not needed until the ServiceFactory is called to provide the service object. The service properties for this registration consist of the component properties as defined in *Service Properties* on page 324.

The activation of a component configuration must be delayed until its service is requested. When the service is requested, if the service has the scope attribute set to bundle, SCR must create and activate a unique component configuration for each bundle requesting the service. If the service has the scope attribute set to prototype, SCR must create and activate a unique component configuration for each distinct request for the service. Otherwise, if the service has the scope attribute set to singleton, SCR must activate a single component configuration which is used by all requests for the service. A component instance can determine the bundle it was activated for by calling the `getUsingBundle()` method on the Component Context.

The activation of delayed components is depicted in a state diagram in Figure 112.3. Notice that multiple component configurations can be created from the REGISTERED state if a delayed component specifies a service scope set to a value other than singleton.

If the service registered by a component configuration becomes unused because there are no more bundles using it, then SCR should deactivate that component configuration. This allows SCR implementations to eagerly reclaim activated component configurations.

Figure 112.3

Delayed Component Configuration

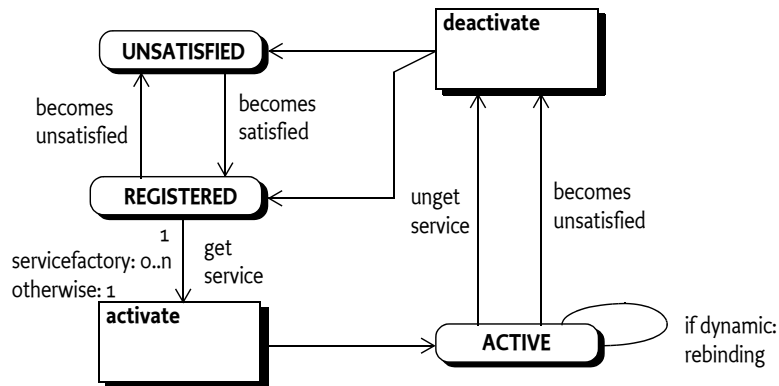

## 112.5.5 Factory Component

SCR must register a Component Factory service as soon as the *component factory* becomes satisfied. The component factory is satisfied when the following conditions are all satisfied:

- The component is enabled.
- Using the component properties specified by the component description, all the component's references are satisfied. A reference is satisfied when the reference specifies optional cardinality or there is at least one target service for the reference



The component factory, however, does not use any of the target services and does not bind to them.

Once any of the listed conditions are no longer true, the component factory becomes unsatisfied and the Component Factory service must be unregistered. Any component configurations activated via the component factory are unaffected by the unregistration of the Component Factory service, but may themselves become unsatisfied for the same reason.

The Component Factory service must be registered under the name `org.osgi.service.component.ComponentFactory` with the following service properties:

- `component.name` - The name of the component.
- `component.factory` - The value of the factory attribute.

The service properties of the Component Factory service must not include the component properties.

New component configurations are created and activated when the `newInstance` method of the Component Factory service is called. If the component description specifies a service, the component configuration is registered as a service under the provided interfaces. The service properties for this registration consist of the component properties as defined in *Service Properties* on page 324.

The service registration must take place before the component configuration is activated. Service unregistration must take place before the component configuration is deactivated.

Figure 112.4 *Factory Component*

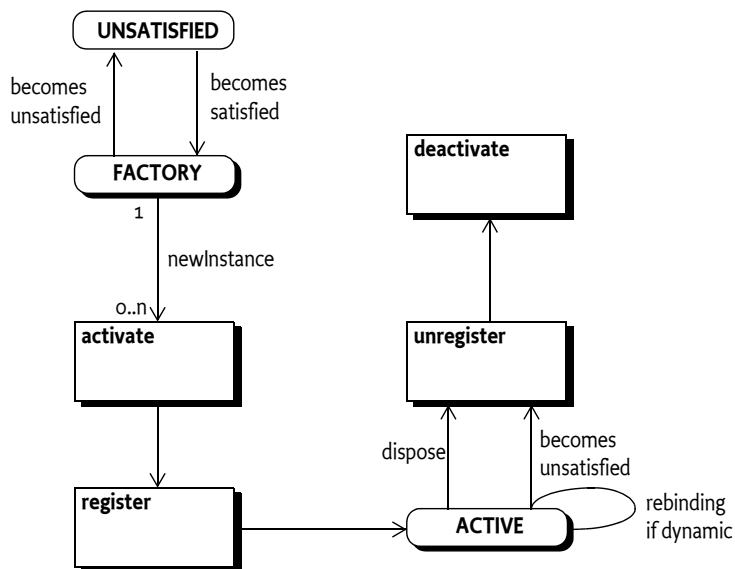

A Component Factory service has a single method: `newInstance(Dictionary)`. This method must create, satisfy and activate a new component configuration and register its component instance as a service if the component description specifies a service. It must then return a `ComponentInstance` object. This `ComponentInstance` object can be used to get the component instance with the `getInstance()` method.

SCR must attempt to satisfy the component configuration created by `newInstance` before activating it. If SCR is unable to satisfy the component configuration given the component properties and the `Dictionary` argument to `newInstance`, the `newInstance` method must throw a `ComponentException`.

The client of the Component Factory service can also deactivate a component configuration with the `dispose()` method on the `ComponentInstance` object. If the component configuration is already

deactivated, or is being deactivated, then this method is ignored. Also, if the component configuration becomes unsatisfied for any reason, it must be deactivated by SCR.

Once a component configuration created by the Component Factory has been deactivated, that component configuration will not be reactivated or used again.

### 112.5.6 Activation

Activating a component configuration consists of the following steps:

1. Load the component implementation class.
2. Create the component instance and component context.
3. Bind the target services. See *Binding Services* on page 318.
4. Call the activate method, if present. See *Activate Method* on page 318.

Component instances must never be reused. Each time a component configuration is activated, SCR must create a new component instance to use with the activated component configuration. A component instance must complete activation before it can be deactivated. Once the component configuration is deactivated or fails to activate due to an exception, SCR must unbind all the component's bound services and discard all references to the component instance associated with the activation.

### 112.5.7 Binding Services

When a component configuration's reference is satisfied, there is a set of zero or more target services for that reference. When the component configuration is activated, a subset of the target services for each reference are bound to the component configuration. The subset is chosen by the cardinality of the reference. See *Reference Cardinality* on page 299.

When binding services, the references are processed in the order in which they are specified in the component description. That is, target services from the first specified reference are bound before services from the next specified reference.

Obtaining the service object for a bound service may result in activating a component configuration of the bound service which could result in an exception. If the loss of the bound service due to the exception causes the reference's cardinality constraint to be violated, then activation of this component configuration will fail. Otherwise the bound service which failed to activate will be considered unbound.

If the reference uses the field strategy, the field must be set. Then, if the reference uses the event strategy, the bind method must be called for each bound service of that reference. If a bind method throws an exception, SCR must log an error message containing the exception with the Log Service, if present, but the activation of the component configuration does not fail.

### 112.5.8 Activate Method

A component instance can have an activate method. The name of the activate method can be specified by the activate attribute. See *Component Element* on page 307. If the activate attribute is not specified, the default method name of activate is used. The prototype of the activate method is:

```
void <method-name>(<arguments>);
```

The activate method can take zero or more arguments. Each argument must be of one of the following types:

- `ComponentContext` - The component instance will be passed the Component Context for the component configuration.
- `BundleContext` - The component instance will be passed the Bundle Context of the component's bundle.

- Map - The component instance will be passed an unmodifiable Map containing the component properties.
- A component property type - The component instance will be passed an instance of the component property type which allows type safe access to component properties defined by the component property type. See *Component Property Types* on page 330.

A suitable method is selected using the following priority:

1. The method takes a single argument and the type of the argument is `org.osgi.service.component.ComponentContext`.
2. The method takes a single argument and the type of the argument is `org.osgi.framework.BundleContext`.
3. The method takes a single argument and the type of the argument is a component property type.
4. The method takes a single argument and the type of the argument is `java.util.Map`.
5. The method takes two or more arguments and the type of each argument must be `org.osgi.service.component.ComponentContext`, `org.osgi.framework.BundleContext`, a component property type or `java.util.Map`. If multiple methods match this rule, this implies the method name is overloaded and SCR may choose any of the methods to call.
6. The method takes zero arguments.

When searching for the activate method to call, SCR must locate a suitable method as specified in *Locating Component Methods and Fields* on page 334. If the activate attribute is specified and no suitable method is located, SCR must log an error message with the Log Service, if present, and the component configuration is not activated.

If an activate method is located, SCR must call this method to complete the activation of the component configuration. If the activate method throws an exception, SCR must log an error message containing the exception with the Log Service, if present, and the component configuration is not activated.

### 112.5.9 Component Context

The Component Context is made available to a component instance via the `activate` and `deactivate` methods. It provides the interface to the execution context of the component, much like the Bundle Context provides a bundle the interface to the Framework. A Component Context should therefore be regarded as a capability and not shared with other components or bundles.

Each distinct component instance receives a unique Component Context. Component Contexts are not reused and must be discarded when the component configuration is deactivated.

### 112.5.10 Bound Service Replacement

If an active component configuration has a dynamic reference with unary cardinality and the bound service is modified or unregistered and ceases to be a target service, or the `policy` option is `greedy` and a better target service becomes available then SCR must attempt to replace the bound service with a new bound service.

If the reference uses the field strategy, the field must be set for the replacement bound service. Then, if the reference uses the event strategy, SCR must first bind the new bound service and then unbind the outgoing service. This reversed order allows the component to not have to handle the inevitable gap between the unbind and bind methods. However, this means that in the unbind method care must be taken to not overwrite the newly bound service. For example, the following code handles the associated concurrency issues and simplify handling the reverse order.

```
final AtomicReference<LogService> log = new AtomicReference<LogService>();
```

```

void setLogService( LogService log ) {
    this.log.set(log);
}
void unsetLogService( LogService log ) {
    this.log.compareAndSet(log, null);
}

```

If the dynamic reference falls below the minimum cardinality, the component configuration must be deactivated because the cardinality constraints will be violated.

If a component configuration has a static reference and a bound service is modified or unregistered and ceases to be a target service, or the policy-option is greedy and a better target service becomes available then SCR must deactivate the component configuration. Afterwards, SCR must attempt to activate the component configuration again if another target service can be used as a replacement for the outgoing service.

### 112.5.11 Updated

If an active component is bound to a service that modifies its service properties then the component can be updated. If the reference uses the field strategy and the field holds the service properties, the field must be set for the updated bound service. Then, if the reference uses the event strategy and specifies an updated method, the updated method must be called.

### 112.5.12 Modification

Modifying a component configuration can occur if the component description specifies the modified attribute and the component properties of the component configuration use a Configuration object from the Configuration Admin service and that Configuration object is modified without causing the component configuration to become unsatisfied. If this occurs, the component instance will be notified of the change in the component properties.

If the modified attribute is not specified, then the component configuration will become unsatisfied if its component properties use a Configuration object and that Configuration object is modified in any way.

Modifying a component configuration consists of the following steps:

1. Update the component context for the component configuration with the modified configuration properties.
2. Call the modified method. See *Modified Method* on page 320.
3. Modify the bound services for the dynamic references if the set of target services changed due to changes in the target properties. See *Bound Service Replacement* on page 319.
4. If the component configuration is registered as a service, modify the service properties.

A component instance must complete activation, or a previous modification, before it can be modified.

See *Configuration Changes* on page 326 for more information.

### 112.5.13 Modified Method

The name of the modified method is specified by the modified attribute. See *Component Element* on page 307. The prototype and selection priority of the modified method is identical to that of the activate method. See *Activate Method* on page 318.

SCR must locate a suitable method as specified in *Locating Component Methods and Fields* on page 334. If the modified attribute is specified and no suitable method is located, SCR must log an error message with the Log Service, if present, and the component configuration becomes unsatisfied and is deactivated as if the modified attribute was not specified.

If a modified method is located, SCR must call this method to notify the component configuration of changes to the component properties. If the modified method throws an exception, SCR must log an error message containing the exception with the Log Service, if present and continue processing the modification.

### 112.5.14 Deactivation

Deactivating a component configuration consists of the following steps:

1. Call the deactivate method, if present. See *Deactivate Method* on page 321.
2. Unbind any bound services. See *Unbinding* on page 322.
3. Release all references to the component instance and component context.

A component instance must complete activation or modification before it can be deactivated. A component configuration can be deactivated for a variety of reasons. The deactivation reason can be received by the deactivate method. The following reason values are defined:

- 0 - Unspecified.
- 1 - The component was disabled.
- 2 - A reference became unsatisfied.
- 3 - A configuration was changed.
- 4 - A configuration was deleted.
- 5 - The component was disposed.
- 6 - The bundle was stopped.

Once the component configuration is deactivated, SCR must discard all references to the component instance and component context associated with the activation.

### 112.5.15 Deactivate Method

A component instance can have a deactivate method. The name of the deactivate method can be specified by the deactivate attribute. See *Component Element* on page 307. If the deactivate attribute is not specified, the default method name of deactivate is used. The prototype of the deactivate method is:

```
void <method-name>(<arguments>);
```

The deactivate method can take zero or more arguments. Each argument must be assignable from one of the following types:

- `ComponentContext` - The component instance will be passed the Component Context for the component.
- `BundleContext` - The component instance will be passed the Bundle Context of the component's bundle.
- `Map` - The component instance will be passed an unmodifiable Map containing the component properties.
- A component property type - The component instance will be passed an instance of the component property type which allows type safe access to component properties defined by the component property type. See *Component Property Types* on page 330.
- `int` or `Integer` - The component instance will be passed the reason the component configuration is being deactivated. See *Deactivation* on page 321.

A suitable method is selected using the following priority:

1. The method takes a single argument and the type of the argument is `org.osgi.service.component.ComponentContext`.

2. The method takes a single argument and the type of the argument is `org.osgi.framework.BundleContext`.
3. The method takes a single argument and the type of the argument is a component property type.
4. The method takes a single argument and the type of the argument is `java.util.Map`.
5. The method takes a single argument and the type of the argument is `int`.
6. The method takes a single argument and the type of the argument is `java.lang.Integer`.
7. The method takes two or more arguments and the type of each argument must be `org.osgi.service.component.ComponentContext`, `org.osgi.framework.BundleContext`, a component property type, `java.util.Map`, `int` or `java.lang.Integer`. If multiple methods match this rule, this implies the method name is overloaded and SCR may choose any of the methods to call.
8. The method takes zero arguments.

When searching for the deactivate method to call, SCR must locate a suitable method as specified in *Locating Component Methods and Fields* on page 334. If the deactivate attribute is specified and no suitable method is located, SCR must log an error message with the Log Service, if present, and the deactivation of the component configuration will continue.

If a deactivate method is located, SCR must call this method to commence the deactivation of the component configuration. If the deactivate method throws an exception, SCR must log an error message containing the exception with the Log Service, if present, and the deactivation of the component configuration will continue.

### 112.5.16 Unbinding

When a component configuration is deactivated, the bound services are unbound from the component configuration.

When unbinding services, the references are processed in the reverse order in which they are specified in the component description. That is, target services from the last specified reference are unbound before services from the previous specified reference.

If the reference uses the event strategy, the unbind method must be called for each bound service of that reference. If an unbind method throws an exception, SCR must log an error message containing the exception with the Log Service, if present, and the deactivation of the component configuration will continue. Then, if the reference uses the field strategy, the field must be set to null.

### 112.5.17 Life Cycle Example

A component could declare a dependency on the Http Service to register some resources.

```
<?xml version="1.0" encoding="UTF-8"?>
<scr:component name="example.binding"
  xmlns:scr="http://www.osgi.org/xmlns/scr/v1.3.0">
  <implementation class="com.acme.impl.Binding"/>
  <reference name="LOG"
    interface="org.osgi.service.log.LogService"
    cardinality="1..1"
    policy="static"
  />
  <reference name="HTTP"
    interface="org.osgi.service.http.HttpService"
    cardinality="0..1"
    policy="dynamic"
    bind="setHttp"
    unbind="unsetHttp"
  />
</scr:component>
```

```

    />
</scr:component>

```

The component implementation code looks like:

```

public class Binding {
    LogService log;
    HttpService http;

    private void setHttp(HttpService h) {
        http = h;
        // register servlet
    }
    private void unsetHttp(HttpService h){
        if (http == h)
            http = null;
        // unregister servlet
    }
    private void activate(ComponentContext context ) {
        log = (LogService) context.locateService("LOG");
    }
    private void deactivate(ComponentContext context ) {...}
}

```

This example is depicted in a sequence diagram in Figure 112.5 with the following scenario:

1. A bundle with the example.Binding component is started. At that time there is a Log Service l1 and a Http Service h1 registered.
2. The Http Service h1 is unregistered
3. A new Http Service h2 is registered
4. The Log Service h1 is unregistered.

Figure 112.5 Sequence Diagram for binding

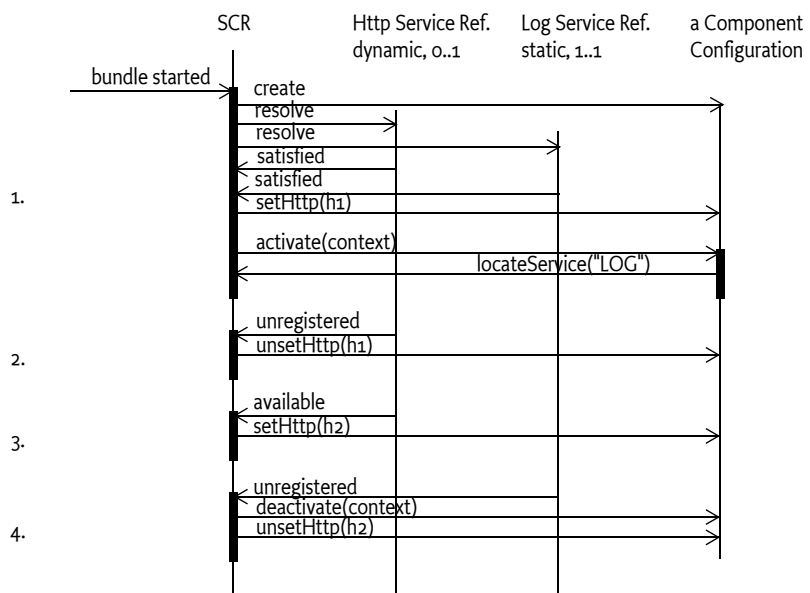

## 112.6 Component Properties

Each component configuration is associated with a set of component properties. The component properties are specified in the following *configuration sources* (in order of precedence):

1. Properties specified in the argument of the `ComponentFactory.newInstance` method. This is only applicable for factory components.
2. Properties retrieved from the OSGi Configuration Admin service in Configuration objects whose PID matches a *configuration PID*. The configuration PIDs are specified by the `configuration-pid` attribute of the component element. See *Component Element* on page 307. If no `configuration-pid` attribute is specified, the component name is used as the default configuration PID. If multiple configuration PIDs are specified, the order of precedence follows the order the configuration PIDs are specified in the component description. That is, the precedence for the configuration for an earlier specified configuration PID is lower than the precedence for the configurations for a later specified configuration PID.
3. Properties specified in the component description. Properties specified later in the component description override properties that have the same name specified earlier. Properties can be specified in the component description in the following ways:
  - `target` attribute of reference elements - Sets the target property of the reference. See *Target Property* on page 325. The value of the `target` attribute is used for the value of a target property.
  - `property` and `properties` elements - See *Property and Properties Elements* on page 309.

The precedence behavior allows certain default values to be specified in the component description while allowing properties to be replaced and extended by:

- A configuration in Configuration Admin
- The argument to the `ComponentFactory.newInstance` method

Normally, a property value from a higher precedence configuration source replace a property value from a lower precedence configuration source. However, the `service.pid` property values receive different treatment. For the `service.pid` property, if the property appears multiple times in the configuration sources, SCR must aggregate all the values found into a `Collection<String>` having an iteration order such that the first item in the iteration is the property value from the lowest precedence configuration source and the last item in the iteration is the property value from the highest precedence configuration source. If the component description specifies multiple configuration PIDs, then the order of the `service.pid` property values from the corresponding configurations matches the order the configuration PIDs are specified in the component description. The values of the `service.pid` component property are the values as they come from the configuration sources which, for Configuration objects, may be more detailed than the configuration PIDs specified in the component description.

SCR always adds the following component properties, which cannot be overridden:

- `component.name` - The component name.
- `component.id` - A unique value (Long) that is larger than all previously assigned values. These values are not persistent across restarts of SCR.

### 112.6.1 Service Properties

When SCR registers a service on behalf of a component configuration, SCR must follow the recommendations in *Property Propagation* on page 95 and must not propagate private configuration properties. That is, the service properties of the registered service must be all the component properties of the component configuration whose property names do not start with full stop (' \u002E).



Component properties whose names start with full stop are available to the component instance but are not available as service properties of the registered service.

## 112.6.2 Reference Properties

This specification defines some component properties which are associated with specific component references. These are called *reference properties*. The name of a reference property for a reference is the name of the reference appended with a full stop ('.' \u002E) and a suffix unique to the reference property. Reference properties can be set wherever component properties can be set.

All component property names starting with a reference name followed by a full stop ('.' \u002E) are reserved for use by this specification.

Following are the reference properties defined by this specification.

### 112.6.2.1 Target Property

The *target property* is a reference property which aids in the selection of target services for the reference. See *Selecting Target Services* on page 305. The name of a target property is the name of a reference appended with `.target`. For example, the target property for a reference with the name `http` would have the name `http.target`. The value of a target property is a filter string used to select targets services for the reference.

The target property for a reference can also be set by the `target` attribute of the reference element. See *Reference Element* on page 312.

### 112.6.2.2 Minimum Cardinality Property

The initial minimum cardinality of a reference is specified by the optionality: the first part of the cardinality. It is either 0 or 1. The minimum cardinality of a reference cannot exceed the multiplicity: the second part of the cardinality. See *Reference Cardinality* on page 299 for more information on the cardinality of a reference.

The *minimum cardinality property* is a reference property which can be used to raise the minimum cardinality of a reference from its initial value. That is, a 0..1 cardinality can be raised to a 1..1 cardinality by setting the reference's minimum cardinality property to 1, and a 0..n or 1..n cardinality can be raised to a m..n cardinality by setting the reference's minimum cardinality property to m such that m is a positive integer. The minimum cardinality of a reference cannot be lowered. That is, a 1..1 or 1..n cardinality can be lowered to a 0..1 or 0..n cardinality because the component was coded to expect at least one bound service.

The name of a minimum cardinality property is the name of a reference appended with `.cardinality.minimum`. For example, the minimum cardinality property for a reference with the name `http` would have the name `http.cardinality.minimum`. The value of a minimum cardinality property must be a positive integer or a value that can be coerced into a positive integer. See *Coercing Component Property Values* on page 332 for information on coercing property values. If the numerical value of the minimum cardinality property is not valid for the reference's cardinality or the minimum cardinality property value cannot be coerced into a numerical value, then the minimum cardinality property must be ignored.

SCR must support the minimum cardinality property for all components even those with component descriptions in older namespaces.

## 112.7 Deployment

A component description contains default information to select target services for each reference. However, when a component is deployed, it is often necessary to influence the target service selection in a way that suits the needs of the deployer. Therefore, SCR uses Configuration objects from

Configuration Admin to replace and extend the component properties for a component configuration. That is, through Configuration Admin, a deployer can configure component properties.

A component's configuration PIDs are used as keys for obtaining additional component properties from Configuration Admin. When *matching* a configuration PID to a Configuration object, SCR must use the Configuration object with the best matching PID for the component's bundle. See *Targeted PIDs* on page 91 for more information on targeted PIDs and *Extenders and Targeted PIDs* on page 92 for more information on selecting the Configuration object with the best matching PID.

The following situations can arise when looking for Configuration objects:

- *No Configuration* - If the component's configuration-policy is set to ignore or there are no Configurations with a PID or factory PID matching any of the configuration PIDs, then component configurations will not obtain component properties from Configuration Admin. Only component properties specified in the component description or via the `ComponentFactory.newInstance` method will be used.
- *Not Satisfied* - If the component's configuration-policy is set to require and, for each configuration PID, there is no Configuration with a matching PID or factory PID, then the component configuration is not satisfied and will not be activated.
- *Single Configurations* - If none of the configuration PIDs matches a factory PID, then component configurations will obtain additional component properties from Configuration Admin.
- *Factory Configuration* - If one of the configuration PIDs matches a factory PID, with zero or more Configurations, then for each Configuration of the factory PID, a component configuration must be created that will obtain additional component properties from Configuration Admin.

It is a configuration error if more than one of the configuration PIDs match a factory PID and SCR must log an error message with the Log Service, if present. If the configuration-policy is set to optional, the component configuration must be satisfied without the configurations PIDs which match a factory PID. If the configuration-policy is set to require, the component configuration is not satisfied and will not be activated.

A factory configuration must not be used if the component is a factory component. This is because SCR is not free to create component configurations as necessary to support multiple Configurations. When SCR detects this condition, it must log an error message with the Log Service, if present, and ignore the component description.

SCR must obtain the Configuration objects from the Configuration Admin service using the Bundle Context of the bundle containing the component.

For example, there is a component named `com.acme.client` with a reference named `HTTP` that requires an `Http Service` which must be bound to a component `com.acme.httpservlet` which provides an `Http Service`. A deployer can establish the following configuration:

```
[PID=com.acme.client, factoryPID=null]
HTTP.target = (component.name=com.acme.httpservlet)
```

### 112.7.1 Configuration Changes

SCR must track changes in the Configuration objects matching the configuration PIDs of a component description. Changes include the creating, updating and deleting of Configuration objects matching the configuration PIDs. The actions SCR must take when a configuration change for a component configuration occurs are based upon how the configuration-policy and modified attributes are specified in the component description, whether a component configuration becomes satisfied, remains satisfied or becomes unsatisfied and the type and number of matching Configuration objects.

With targeted PIDs, multiple Configuration objects can exist which can match a configuration PID. Creation of a Configuration object with a better matching PID than a Configuration object currently being used by a component configuration results in a configuration change for the component

configuration with the new Configuration object replacing the currently used Configuration object. Deletion of a Configuration object currently being used by a component configuration when there is another Configuration object matching the configuration PID also results in a configuration change for the component configuration with the Configuration object having the best matching PID replacing the currently used, and now deleted, Configuration object.

#### **112.7.1.1 Ignore Configuration Policy**

For configuration-policy of ignore, component configurations are unaffected by configuration changes since the component properties do not include properties from Configuration objects.

#### **112.7.1.2 Require Configuration Policy**

For configuration-policy of require, component configurations require a Configuration object for each specified configuration PID. With a factory configuration, there can be zero or more matching Configuration objects which will result in a component configuration for each Configuration object of the factory configuration. With a factory component, multiple component configurations can be created all using the matching Configuration objects.

A configuration change can cause a component configuration to become unsatisfied if any of the following occur:

- Each configuration PID of the component description does not have a matching Configuration object.
- A target property change results in a bound service of a static reference ceasing to be a target service.
- A target property change results in unbound target services for a static reference with the greedy policy option.
- A target property change or minimum cardinality property change results in a reference falling below the minimum cardinality.
- The component description does not specify the modified attribute.

#### **112.7.1.3 Optional Configuration Policy**

For configuration-policy of optional, component configurations do not require Configuration objects. Since matching Configuration objects are optional, component configurations can be satisfied with zero or more matched configuration PIDs. If a Configuration object is then created which matches a configuration PID, this is a configuration change for the component configurations that are not using the created Configuration object. If a Configuration object is deleted which matches a configuration PID, this is a configuration change for the component configurations using the deleted Configuration object.

Furthermore, with a factory configuration matching a configuration PID, the factory configuration can provide zero or more Configuration objects which will result in a component configuration for each Configuration object or a single component configuration when zero matching Configuration objects are provided. With a factory component, multiple component configurations can be created all using the Configuration objects matching the configuration PIDs.

A configuration change can cause a component configuration to become unsatisfied if any of the following occur:

- A target property change results in a bound service of a static reference ceasing to be a target service.
- A target property change results in unbound target services for a static reference with the greedy policy option.
- A target property change or minimum cardinality property change results in a reference falling below the minimum cardinality.
- The component description does not specify the modified attribute.

**112.7.1.4****Configuration Change Actions**

If a component configuration becomes unsatisfied:

- SCR must deactivate the component configuration.
- If the component configuration was not created from a factory component, SCR must attempt to satisfy the component configuration with the current configuration state.

If a component configuration remains satisfied:

- If the component configuration has been activated, the modified method is called to provide the updated component properties. See *Modification* on page 320 for more information.
- If the component configuration is registered as a service, SCR must modify the service properties.

## 112.8 Annotations

A number of CLASS retention annotations have been provided to allow tools to construct the component description XML from the Java class files. The Component Annotations are intended to be used during build time to generate the component description XML.

Component Property Types, which are user defined annotations, can be used to describe component properties in the component description XML and to access those component properties at runtime in a type safe manner.

**112.8.1****Component Annotations**

The Component Annotations provide a convenient way to create the component description XML during build time. Since annotations are placed in the source file and can use types, fields, and methods, they can significantly simplify the use of Declarative Services.

The Component Annotations are build time annotations because one of the key aspects of Declarative Services is its laziness. SCR can easily read the component description XML from the bundle, preprocess it, and cache the results between framework invocations. This way it is unnecessary to load a class from the bundle when the bundle is started and/or scan the classes for annotations. Component Annotations are not recognized by SCR at runtime.

The Component Annotations are not inherited, they can only be used on a given class, annotations on its super class hierarchy or interfaces are not taken into account.

The primary annotation is the [Component](#) annotation. It indicates that a class is a component. Its defaults create the easiest to use component:

- Its name is the class name
- It registers all of the class's directly implemented interfaces as services
- The instance will be shared by all bundles
- It is enabled
- It is immediate if it has no services, otherwise it is delayed
- It has an optional configuration policy
- The configuration PID is the class name

For example, the following class registers a Speech service that can run on a Macintosh:

```
public interface Speech {
    void say(String what) throws Exception;
}
```

```
@Component
```

```
public class MacSpeech implements Speech {
    ScriptEngine engine =
        new ScriptEngineManager().getEngineByName("AppleScript");

    public void say(String message) throws Exception {
        engine.eval("say \"" + message.replace("'", "\'") + "\"");
    }
}
```

The previous example would be processed at build time into a component description similar to the following XML:

```
<scr:component name="com.example.MacSpeech"
  xmlns:scr="http://www.osgi.org/xmlns/scr/v1.3.0">
  <implementation class="com.acme.impl.MacSpeech"/>
  <service>
    <provide interface="com.acme.service.speech.Speech"/>
  </service>
</scr:component>
```

It is possible to add activate and deactivate methods on the component with the [Activate](#) and [Deactivate](#) annotations. If the component wants to be updated for changes in the configuration properties than it can also indicate the modified method with the [Modified](#) annotation. For example:

```
@Activate
void open(Map<String,?> properties) { ... }

@Deactivate
void close() { ... }

@Modified
void modified(Map<String,?> properties) { ... }
```

If a component has dependencies on other services then they can be referenced with the [Reference](#) annotation that can be applied to a bind method or a field. For a bind method, the defaults for the [Reference](#) annotation are:

- The name of the bind method or field is used for the name of the reference.
- 1:1 cardinality.
- Static reluctant policy.
- The requested service is the type of the first argument of the bind method.
- It will infer a default unset method and updated method based on the name of the bind method.

For example:

```
@Reference(cardinality=MULTIPLE, policy=DYNAMIC)
void setLogService( LogService log, Map<String,?> props) { ... }
void unsetLogService( LogService log ) { ... }
void updatedLogService( Map<String,?> map ) { ... }
```

For a field, the defaults for the [Reference](#) annotation are:

- The name of the bind method or field is used for the name of the reference.
- 1:1 cardinality if the field is not a collection. 0..n cardinality if the field is a collection.
- Static reluctant policy if the field is not declared volatile. Dynamic reluctant policy if the field is declared volatile.

- The requested service is the type of the field.

For example:

```
@Reference
volatile Collection<LogService> log;
```

## 112.8.2 Component Property Types

Component properties can be defined and accessed through a user defined annotation type, called a *component property type*, containing the property names, property types and default values. A component property type allows properties to be defined and accessed in a type safe manner. The following example shows the definition of a component property type called `Config` which defines three properties where the name of the property is the name of the method, the type of the property is the return type of the method and the default value for the property is the default value of the method.

```
@interface Config {
    boolean enabled() default true;
    String[] names() default {"a", "b"};
    String topic() default "default/topic";
}
```

Component property types can be referenced as argument types in the component's life cycle methods, `activate`, `deactivate`, and `modified`, and used in the method implementation to access component property values in a type safe manner. The following example shows the `activate` method taking the example `Config` component property type as an argument type and the method implementation accesses component property values by invoking methods on the component property type argument.

```
@Component
public class MyComponent {
    void activate(Config config) {
        if (config.enabled()) {
            // do something
        }
        for (String name: config.names()) {
            // do something with each name
        }
    }
}
```

If a component implementation needs to access component properties which are not represented by a component property type, it can use a life cycle method signature which also receives the properties map in addition to component property types. For example:

```
@Component
public class MyComponent {
    void activate(Config config, Map<String, ?> allProperties) {
        if (config.enabled()) {
            // do something
        }
        if (allProperties.get("other.prop") != null) {
            // do something
        }
    }
}
```

Component property types must be defined as annotation types even though they are not applied as annotations but are rather used as life cycle method argument types. This is done for two reasons. First, the limitations on annotation type definitions make them well suited for component property types. The methods must have no arguments and the return types supported are limited to a set which is well suited for component properties. Second, annotation types support default values which is useful for defining the default value of a component property.

At build time, the component property types must be processed to potentially generate property elements in the component description. See *Ordering of Generated Properties* on page 332.

At runtime, when SCR needs to call a lifecycle method on a component instance which takes an argument whose type is a component property type, SCR must construct an instance of the component property type whose methods are backed by the values of the component properties for the component instance. This object is then passed to the life cycle method which can use the object to obtain the property values in a type safe manner.

### 112.8.2.1 Component Property Mapping

Each method of a configuration property type is mapped to a component property. The property name is derived from the method name. Certain common property name characters, such as full stop ('.' \u002E) are not valid in Java identifiers. So the name of a method must be converted to its corresponding property name as follows:

- A single dollar sign ('\$' \u0024) is removed unless it is followed by another dollar sign in which case the two consecutive dollar signs ("\$\$") are converted to a single dollar sign.
- A single low line ('\_' \u005F) is converted into a full stop ('.' \u002E) unless it is followed by another low line in which case the two consecutive low lines ("\_\_") are converted to a single low line.
- All other characters are unchanged.

Table 112.9 contains some name mapping examples.

Table 112.9 *Component Property Name Mapping Examples*

Component Property Type Method Name	Component Property Name
myProperty143	myProperty143
\$new	new
my\$\$prop	my\$prop
dot_prop	dot.prop
_secret	.secret
another__prop	another_prop
three___prop	three_.prop
four_\$_prop	four._prop
five_\$_prop	five..prop

The property type can be directly derived from the type of the method. All types supported for annotation elements can be used except for annotation types. Method types of an annotation type or array thereof are not supported. A tool processing the component property types must declare an error during processing in this case.

If the method type is `Class` or `Class[]`, then the property type must be `String` or `String[]`, respectively, whose values are fully qualified class names in the form returned by the `Class.getName()` method.

If the method type is an enumeration type or an array thereof, then the property type must be `String` or `String[]`, respectively, whose values are the names of the enum constants in the form returned by the `Enum.name()` method.

**112.8.2.2 Coercing Component Property Values**

When a component property type is used as an argument for a life cycle method, SCR must create an object that implements the component property type and maps the methods of the component property type to component properties. The name of the method is converted to the property name as described in *Component Property Mapping* on page 331. The property value may need to be coerced to the type of the method. In Table 112.10, the columns are source types, that is, the type of the component property value, and the rows are target types, that is, the method types. The property value is *v*; *number* is a primitive numerical type and *Number* is a wrapper numerical type. An invalid coercion is represented by throw. Such a coercion attempt must result in throwing a Component Exception when the component property type method is called. Any other coercion error, such as parsing a non-numerical string to a number or the inability to coerce a string into a Class or enum object, must be wrapped in a Component Exception and thrown when the component property type method is called.

Table 112.10 Coercion From Property Value to Method Type

target \ source	String	Boolean	Character	Number	Collection/array
<b>String</b>	<i>v</i>	<i>v</i> . toString()	<i>v</i> . toString()	<i>v</i> . toString()	If <i>v</i> has no elements, null; otherwise the first element of <i>v</i> is coerced.
<b>boolean</b>	Boolean.parseBoolean( <i>v</i> )	<i>v</i> . booleanValue()	<i>v</i> . charValue() != 0	<i>v</i> . numberValue() != 0	If <i>v</i> has no elements, false; otherwise the first element of <i>v</i> is coerced.
<b>char</b>	<i>v</i> . length() > 0 ? <i>v</i> . charAt(0) : 0	<i>v</i> . booleanValue() ? 1 : 0	<i>v</i> . charValue()	(char) <i>v</i> . numberValue()	If <i>v</i> has no elements, 0; otherwise the first element of <i>v</i> is coerced.
<b>number</b>	<i>Number</i> . parseNumber( <i>v</i> )	<i>v</i> . booleanValue() ? 1 : 0	( <i>number</i> ) <i>v</i> . charValue()	<i>v</i> . numberValue()	If <i>v</i> has no elements, 0; otherwise the first element of <i>v</i> is coerced.
<b>Class</b>	Bundle.loadClass( <i>v</i> )	throw	throw	throw	If <i>v</i> has no elements, null; otherwise the first element of <i>v</i> is coerced.
<b>EnumType</b>	<i>EnumType</i> . valueOf( <i>v</i> )	throw	throw	throw	If <i>v</i> has no elements, null; otherwise the first element of <i>v</i> is coerced.
<b>annotation type array</b>	throw	throw	throw	throw	throw
	A single element array is created and <i>v</i> is coerced into the single element of the new array.				An array the size of <i>v</i> is created and each element of <i>v</i> is coerced into the corresponding element of the new array.

Component properties whose names do not map to component property type methods are ignored. If there is no corresponding component property for a component property type method, the component property type method must:

- Return 0 for numerical and char method types.
- Return false for boolean method type.
- Return null for String, Class, enum and array method types.
- Throw a ComponentException for annotation method types.

**112.8.3 Ordering of Generated Properties**

The [Component](#) annotation contains two ways to define component properties via the [property](#) and [properties](#) elements. See *Property and Properties Elements* on page 309. If Component Annotations are used to describe the component, then any component property types referenced in the signatures of the component's life cycle methods must also be processed since component prop-



erty types can be used to define component property values as well. See *Component Property Types* on page 330. A tool processing the Component Annotations and the component property types must write the defined component properties into the generated component description in the following order.

1. Properties defined through component property types used in the signatures of the life cycle methods.

If any of the referenced component property types have methods with defaults, then the generated component description must include a property element for each such method with the property name mapped from the method name, the property type mapped from the method type, and the property value set to the method's default value. See *Component Property Mapping* on page 331. The generated property elements must be added to the component description by processing the component property types in the following order. First, the component property types used as arguments to the activate method, followed by the component property types used as arguments to the modified method and finally the component property types used as arguments to the deactivate method. If a method has more than one component property type argument, the component property types are processed in the order of the method arguments.

For component property type methods without a default value, a property element must not be generated.

2. `property` element of the `Component` annotation.
3. `properties` element of the `Component` annotation.

This means that the properties defined through component property types are declared first in the generated component description, followed by all properties defined through the `property` element of the `Component` annotation and finally the properties entries defined through the `properties` element of the `Component` annotation.

Since property values defined later in the component description override property values defined earlier in the component description, this means that property values defined in `properties` element of the `Component` annotation can override property values defined in `property` element of the `Component` annotation which can override values defined by default values in the component property types used in life cycle method signatures.

## 112.9 Service Component Runtime

Service Component Runtime (SCR) is the actor that manages the components and their life cycle and allows introspection of the components.

### 112.9.1 Relationship to OSGi Framework

SCR must have access to the Bundle Context of any bundle that contains a component. SCR needs access to the Bundle Context for the following reasons:

- To be able to register and get services on behalf of a bundle with components.
- To interact with the Configuration Admin on behalf of a bundle with components.
- To provide a component its Bundle Context when the Component Context `getBundleContext` method is called.

SCR should use the `Bundle.getBundleContext()` method to obtain the Bundle Context reference.

### 112.9.2 Starting and Stopping SCR

When SCR is implemented as a bundle, any component configurations activated by SCR must be deactivated when the SCR bundle is stopped. When the SCR bundle is started, it must process any

components that are declared in bundles that are started. This includes bundles which are started and are awaiting lazy activation.

### 112.9.3 Logging Error Messages

When SCR must log an error message to the Log Service, it must use a Log Service obtained using the component's Bundle Context so that the resulting Log Entry is associated with the component's bundle.

If SCR is unable to obtain, or use, a Log Service using the component's Bundle Context, then SCR must log the error message to a Log Service obtained using SCR's bundle context to ensure the error message is logged.

### 112.9.4 Locating Component Methods and Fields

SCR will need to locate activate, deactivate, modified, bind, updated, and unbind methods as well as fields in a component instance. These members will be located, and called or modified, using reflection. The declared members of each class in the component implementation class's hierarchy are examined for a suitable member. If a suitable member is found in a class, and it is accessible to the component implementation class, then that member must be used. If suitable members are found in a class but none of the suitable members are accessible by the component implementation class, then the search for suitable members terminates with no suitable member having been located. If no suitable members are found in a class, the search continues in the superclass.

Only members that are accessible to the component implementation class will be used. If the member has the public or protected access modifier, then access is permitted. Otherwise, if the member has the private access modifier, then access is permitted only if the member is declared in the component implementation class. Otherwise, if the member has default access, also known as package private access, then access is permitted only if the member is declared in the component implementation class or if the member is declared in a superclass and all classes in the hierarchy from the component implementation class to the superclass, inclusive, are in the same package and loaded by the same class loader.

It is recommended that these members should not be declared with the public access modifier so that they do not appear as public members on the component instance when it is used as a service object. Having these members declared public allows any code to call or access the members with reflection, even if a Security Manager is installed. These members are generally intended to only be called or modified by SCR.

### 112.9.5 Bundle Activator Interaction

A bundle containing components may also declare a Bundle Activator. Such a bundle may also be marked for lazy activation. Since components are activated by SCR and Bundle Activators are called by the OSGi Framework, a bundle using both components and a Bundle Activator must take care. The Bundle Activator's start method must not rely upon SCR having activated any of the bundle's components. However, the components can rely upon the Bundle Activator's start method having been called. That is, there is a *happens-before* relationship between the Bundle Activator's start method being run and the components being activated.

### 112.9.6 Introspection

SCR provides an introspection API for examining the runtime state of the components in bundles processed by SCR. SCR must register a [ServiceComponentRuntime](#) service upon startup. The Service Component Runtime service provides methods to inspect the component descriptions and component configurations as well as inspect and modify the enabled state of components. The service uses *Data Transfer Objects (DTO)* as arguments and return values. The rules for Data Transfer Objects are specified in *OSGi Core Release 6*.

The Service Component Runtime service provides the following methods.

- `getComponentDescriptionDTOs(Bundle...)` - For each specified bundle, if the bundle is active and processed by SCR, the returned collection will contain a `ComponentDescriptionDTO` for each valid component description in the bundle.
- `getComponentDescriptionDTO(Bundle,String)` - If the specified bundle is active and processed by SCR, and the specified bundle contains a valid component description with the specified name, the method will return a `ComponentDescriptionDTO` for the component description.
- `getComponentConfigurationDTOs(ComponentDescriptionDTO)` - If the specified `ComponentDescriptionDTO` represents a valid component description from an active bundle processed by SCR, the returned collection will contain a `ComponentConfigurationDTO` for each component configuration of the component.
- `isComponentEnabled(ComponentDescriptionDTO)` - Returns true if the specified Component Description DTO represents a valid component description from an active bundle processed by SCR, and the component is enabled. Otherwise, the method returns false.
- `enableComponent(ComponentDescriptionDTO)` - If the specified Component Description DTO represents a valid component description from an active bundle processed by SCR, the component is enabled. This method must return after changing the enabled state of the specified component. Any actions that result from this, such as activating or deactivating a component configuration, must occur asynchronously to this method call. The method returns a `Promise` that will be resolved when the actions that result from changing the enabled state of the specified component have completed.
- `disableComponent(ComponentDescriptionDTO)` - If the specified Component Description DTO represents a valid component description from an active bundle processed by SCR, the component is disabled. This method must return after changing the enabled state of the specified component. Any actions that result from this, such as activating or deactivating a component configuration, must occur asynchronously to this method call. The method returns a `Promise` that will be resolved when the actions that result from changing the enabled state of the specified component have completed.

The runtime state of the components can change at any time. So any information returned by these methods only provides a snapshot of the state at the time of the method call.

There are a number of DTOs available via the Service Component Runtime service.

Figure 112.6 Service Component Runtime DTOs

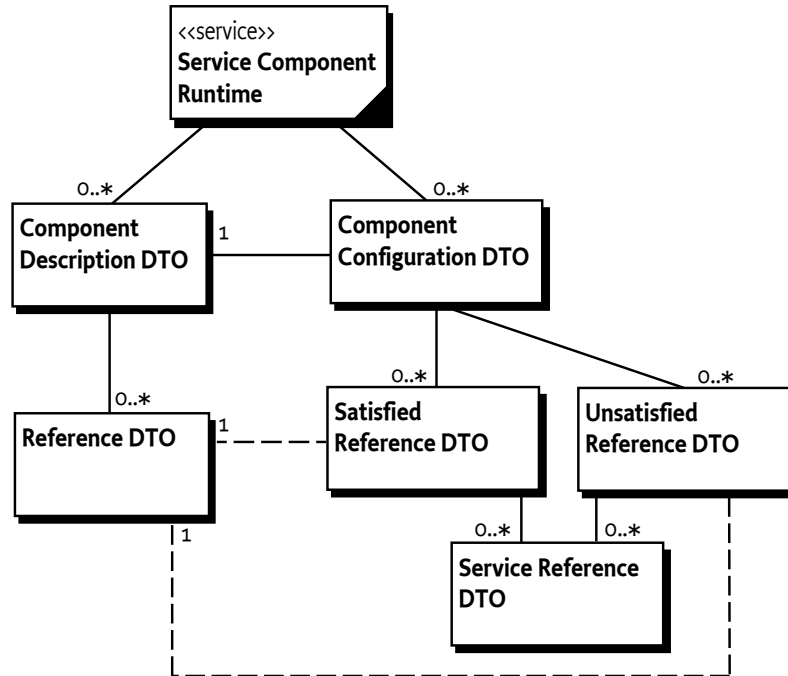

The two main DTOs are [ComponentDescriptionDTO](#), which represents a component description, and [ComponentConfigurationDTO](#), which represents a component configuration. The Component Description DTO contains an array of [ReferenceDTO](#) objects which represent each declared reference in the component description. The Component Configuration DTO contains an array of [SatisfiedReferenceDTO](#) objects and an array of [UnsatisfiedReferenceDTO](#) objects. A Satisfied Reference DTO represents a satisfied reference of the component configuration and an Unsatisfied Reference DTO represents an unsatisfied reference of the component configuration. The Component Configuration DTO for a satisfied component configuration must contain no Unsatisfied Reference DTOs. The Component Configuration DTO for an unsatisfied component configuration may contain some Satisfied Reference DTOs and some Unsatisfied Reference DTOs. This information can be used to diagnose why the component configuration is not satisfied.

## 112.9.7

### Capabilities

SCR must provide the following capabilities.

- A capability in the `org.osgi.extender` namespace declaring an extender with the name `COMPONENT_CAPABILITY_NAME`. This capability must also declare a uses constraint for the `org.osgi.service.component` package. For example:

```

Provide-Capability: osgi.extender;
  osgi.extender="org.osgi.extender";
  version:Version="1.3";
  uses:="org.osgi.service.component"
  
```

This capability must follow the rules defined for the *org.osgi.extender Namespace* on page 993.

A bundle that contains service components should require the `org.osgi.extender` capability from SCR. This requirement will wire the bundle to the SCR implementation and ensure that SCR is using the same `org.osgi.service.component` package as the bundle if the bundle uses that package.

```
Require-Capability: osgi.extender;
    filter:="(&(osgi.extender=osgi.component)(version>=1.3)(!(version>=2.0)))"
```

SCR must only process a bundle's service components if one of the following is true:

- The bundle's wiring has a required wire for at least one `osgi.extender` capability with the name `osgi.component` and the first of these required wires is wired to SCR.
- The bundle's wiring has no required wire for an `osgi.extender` capability with the name `osgi.component`.

Otherwise, SCR must not process the bundle's service components.

- A capability in the `osgi.service` namespace representing the [ServiceComponentRuntime](#) service. This capability must also declare a uses constraint for the `org.osgi.service.component.runtime` package. For example:

```
Provide-Capability: osgi.service;
    objectClass:List<String>=
        "org.osgi.service.component.runtime.ServiceComponentRuntime";
    uses:="org.osgi.service.component.runtime"
```

This capability must follow the rules defined for the *osgi.service Namespace* on page 997.

## 112.10 Security

When Java permissions are enabled, SCR must perform the following security procedures.

### 112.10.1 Service Permissions

Declarative services are built upon the existing OSGi service infrastructure. This means that Service Permission applies regarding the ability to publish, find or bind services.

If a component specifies a service, then component configurations for the component cannot be satisfied unless the component's bundle has `ServicePermission[<provides>, REGISTER]` for each provided interface specified for the service.

If a component's reference does not specify optional cardinality, the reference cannot be satisfied unless the component's bundle has `ServicePermission[<interface>, GET]` for the specified interface in the reference. If the reference specifies optional cardinality but the component's bundle does not have `ServicePermission[<interface>, GET]` for the specified interface in the reference, no service must be bound for this reference.

If a component is a factory component, then the above Service Permission checks still apply. But the component's bundle is not required to have `ServicePermission[ComponentFactory, REGISTER]` as the Component Factory service is registered by SCR.

SCR must have `ServicePermission[ServiceComponentRuntime, REGISTER]` permission to register the [ServiceComponentRuntime](#) service. Administrative bundles wishing to use the [ServiceComponentRuntime](#) service must have `ServicePermission[ServiceComponentRuntime, GET]` permission. In general, this permission should only be granted to administrative bundles to limit access to the potentially intrusive methods provided by this service.

### 112.10.2 Required Admin Permission

SCR requires `AdminPermission[* ,CONTEXT]` because it needs access to the bundle's Bundle Context object with the `Bundle.getBundleContext()` method.

### 112.10.3 Using hasPermission

SCR does all publishing, finding and binding of services on behalf of the component using the Bundle Context of the component's bundle. This means that normal stack-based permission checks will check SCR and not the component's bundle. Since SCR is registering and getting services on behalf of a component's bundle, SCR must call the Bundle.hasPermission method to validate that a component's bundle has the necessary permission to register or get a service.

### 112.10.4 Configuration Multi-Locations and Regions

SCR must ensure a bundle has the proper ConfigurationPermission for a Configuration used by its components when the Configuration has a multi-location. See *Using Multi-Locations* on page 105 for more information on multi-locations and *Regions* on page 105 for more information on regions. If a bundle does not have the necessary permission for a multi-location Configuration, then SCR must act as if the Configuration does not exist for the bundle.

## 112.11 Component Description Schema

This XML Schema defines the component description grammar.

```
<schema xmlns="http://www.w3.org/2001/XMLSchema"
  xmlns:scr="http://www.osgi.org/xmlns/scr/v1.3.0"
  targetNamespace="http://www.osgi.org/xmlns/scr/v1.3.0"
  elementFormDefault="unqualified"
  attributeFormDefault="unqualified"
  version="1.3.0">

  <annotation>
    <documentation xml:lang="en">
      This is the XML Schema for component descriptions used by
      the Service Component Runtime (SCR). Component description
      documents may be embedded in other XML documents. SCR will
      process all XML documents listed in the Service-Component
      manifest header of a bundle. XML documents containing
      component descriptions may contain a single, root component
      element or one or more component elements embedded in a
      larger document. Use of the namespace for component
      descriptions is mandatory. The attributes and subelements
      of a component element are always unqualified.
    </documentation>
  </annotation>
  <element name="component" type="scr:Tcomponent" />
  <complexType name="Tcomponent">
    <sequence>
      <annotation>
        <documentation xml:lang="en">
          Implementations of SCR must not require component
          descriptions to specify the subelements of the component
          element in the order as required by the schema. SCR
          implementations must allow other orderings since
          arbitrary orderings do not affect the meaning of the
          component description. Only the relative ordering of
          property and properties element have meaning.
        </documentation>
      </annotation>
      <choice minOccurs="0" maxOccurs="unbounded">
        <element name="property" type="scr:Tproperty" />
        <element name="properties" type="scr:Tproperties" />
      </choice>
      <element name="service" type="scr:Tservice" minOccurs="0"
        maxOccurs="1" />
      <element name="reference" type="scr:Treference"
        minOccurs="0" maxOccurs="unbounded" />
      <element name="implementation" type="scr:Timplementation" />
      <any namespace="##any" processContents="lax" minOccurs="0"
        maxOccurs="unbounded" />
    </sequence>
    <attribute name="enabled" type="boolean" default="true">
```

```

    use="optional" />
<attribute name="name" type="token" use="optional">
  <annotation>
    <documentation xml:lang="en">
      The default value of this attribute is the value of
      the class attribute of the nested implementation
      element. If multiple component elements use the same
      value for the class attribute of their nested
      implementation element, then using the default value
      for this attribute will result in duplicate names.
      In this case, this attribute must be specified with
      a unique value.
    </documentation>
  </annotation>
</attribute>
<attribute name="factory" type="string" use="optional" />
<attribute name="immediate" type="boolean" use="optional" />
<attribute name="configuration-policy"
  type="scr:Tconfiguration-policy" default="optional" use="optional" />
<attribute name="activate" type="token" use="optional"
  default="activate" />
<attribute name="deactivate" type="token" use="optional"
  default="deactivate" />
<attribute name="modified" type="token" use="optional" />
<attribute name="configuration-pid" use="optional">
  <annotation>
    <documentation xml:lang="en">
      The default value of this attribute is the value of
      the name attribute of this element.
    </documentation>
  </annotation>
  <simpleType>
    <restriction>
      <simpleType>
        <list itemType="token" />
      </simpleType>
      <minLength value="1" />
    </restriction>
  </simpleType>
</attribute>
<anyAttribute processContents="lax" />
</complexType>
<complexType name="Timplementation">
  <sequence>
    <any namespace="##any" processContents="lax" minOccurs="0"
      maxOccurs="unbounded" />
  </sequence>
  <attribute name="class" type="token" use="required" />
  <anyAttribute processContents="lax" />
</complexType>
<complexType name="Tproperty">
  <simpleContent>
    <extension base="string">
      <attribute name="name" type="string" use="required" />
      <attribute name="value" type="string" use="optional" />
      <attribute name="type" type="scr:Tproperty_type"
        default="String" use="optional" />
      <anyAttribute processContents="lax" />
    </extension>
  </simpleContent>
</complexType>
<complexType name="Tproperties">
  <sequence>
    <any namespace="##any" processContents="lax" minOccurs="0"
      maxOccurs="unbounded" />
  </sequence>
  <attribute name="entry" type="string" use="required" />
  <anyAttribute processContents="lax" />
</complexType>
<complexType name="Tservice">
  <sequence>
    <element name="provide" type="scr:Tprovide" minOccurs="1"
      maxOccurs="unbounded" />
  </sequence>
  <!-- It is non-deterministic, per W3C XML Schema 1.0:
  http://www.w3.org/TR/xmlschema-1/#cos-nonambig

```

```

    to use name space="##any" below. -->
    <any namespace="##other" processContents="lax" minOccurs="0"
        maxOccurs="unbounded" />
</sequence>
<attribute name="scope" type="scr:Tservice_scope" default="singleton"
    use="optional" />
<anyAttribute processContents="lax" />
</complexType>
<complexType name="Tprovide">
    <sequence>
        <any namespace="##any" processContents="lax" minOccurs="0"
            maxOccurs="unbounded" />
    </sequence>
    <attribute name="interface" type="token" use="required" />
    <anyAttribute processContents="lax" />
</complexType>
<complexType name="Treference">
    <sequence>
        <any namespace="##any" processContents="lax" minOccurs="0"
            maxOccurs="unbounded" />
    </sequence>
    <attribute name="name" type="token" use="optional">
        <annotation>
            <documentation xml:lang="en">
                The default value of this attribute is the value of
                the interface attribute of this element. If multiple
                instances of this element within a component element
                use the same value for the interface attribute, then
                using the default value for this attribute will result
                in duplicate names. In this case, this attribute
                must be specified with a unique value.
            </documentation>
        </annotation>
    </attribute>
    <attribute name="interface" type="token" use="required" />
    <attribute name="cardinality" type="scr:Tcardinality"
        default="1..1" use="optional" />
    <attribute name="policy" type="scr:Tpolicy" default="static"
        use="optional" />
    <attribute name="policy-option" type="scr:Tpolicy-option"
        default="reluctant" use="optional" />
    <attribute name="target" type="string" use="optional" />
    <attribute name="bind" type="token" use="optional" />
    <attribute name="unbind" type="token" use="optional" />
    <attribute name="updated" type="token" use="optional" />
    <attribute name="scope" type="scr:Treference_scope" default="bundle"
        use="optional" />
    <attribute name="field" type="token" use="optional" />
    <attribute name="field-option" type="scr:Tfield-option" default="replace"
        use="optional" />
    <attribute name="field-collection-type" type="scr:Tfield-collection-type"
        default="service" use="optional" />
    <anyAttribute processContents="lax" />
</complexType>
<simpleType name="Tproperty_type">
    <restriction base="string">
        <enumeration value="String" />
        <enumeration value="Long" />
        <enumeration value="Double" />
        <enumeration value="Float" />
        <enumeration value="Integer" />
        <enumeration value="Byte" />
        <enumeration value="Character" />
        <enumeration value="Boolean" />
        <enumeration value="Short" />
    </restriction>
</simpleType>
<simpleType name="Tcardinality">
    <restriction base="string">
        <enumeration value="0..1" />
        <enumeration value="0..n" />
        <enumeration value="1..1" />
        <enumeration value="1..n" />
    </restriction>
</simpleType>

```



```

<simpleType name="Tpolicy">
  <restriction base="string">
    <enumeration value="static" />
    <enumeration value="dynamic" />
  </restriction>
</simpleType>
<simpleType name="Tpolicy-option">
  <restriction base="string">
    <enumeration value="reluctant" />
    <enumeration value="greedy" />
  </restriction>
</simpleType>
<simpleType name="Tconfiguration-policy">
  <restriction base="string">
    <enumeration value="optional" />
    <enumeration value="require" />
    <enumeration value="ignore" />
  </restriction>
</simpleType>
<simpleType name="Tservice_scope">
  <restriction base="string">
    <enumeration value="singleton" />
    <enumeration value="bundle" />
    <enumeration value="prototype" />
  </restriction>
</simpleType>
<simpleType name="Treference_scope">
  <restriction base="string">
    <enumeration value="bundle" />
    <enumeration value="prototype" />
    <enumeration value="prototype_required" />
  </restriction>
</simpleType>
<simpleType name="Tfield-option">
  <restriction base="string">
    <enumeration value="replace" />
    <enumeration value="update" />
  </restriction>
</simpleType>
<simpleType name="Tfield-collection-type">
  <restriction base="string">
    <enumeration value="service" />
    <enumeration value="properties" />
    <enumeration value="reference" />
    <enumeration value="serviceobjects" />
    <enumeration value="tuple" />
  </restriction>
</simpleType>
<attribute name="must-understand" type="boolean">
  <annotation>
    <documentation xml:lang="en">
      This attribute should be used by extensions to documents
      to require that the document consumer understand the
      extension. This attribute must be qualified when used.
    </documentation>
  </annotation>
</attribute>
</schema>

```

SCR must not require component descriptions to specify the elements in the order required by the schema. SCR must allow other orderings since arbitrary orderings of these elements do not affect the meaning of the component description. Only the relative ordering of property, properties and reference elements have meaning for overriding previously set property values.

The schema is also available in digital form from [5] *OSGi XML Schemas*.

## 112.12 org.osgi.service.component

Service Component Package Version 1.3.

Bundles wishing to use this package must list the package in the Import-Package header of the bundle's manifest. This package has two types of users: the consumers that use the API in this package and the providers that implement the API in this package.

Example import for consumers using the API in this package:

```
Import-Package: org.osgi.service.component; version="[1.3,2.0]"
```

Example import for providers implementing the API in this package:

```
Import-Package: org.osgi.service.component; version="[1.3,1.4]"
```

### 112.12.1 Summary

- `ComponentConstants` - Defines standard names for Service Component constants.
- `ComponentContext` - A Component Context object is used by a component instance to interact with its execution context including locating services by reference name.
- `ComponentException` - Unchecked exception which may be thrown by Service Component Runtime.
- `ComponentFactory` - When a component is declared with the factory attribute on its component element, Service Component Runtime will register a Component Factory service to allow new component configurations to be created and activated rather than automatically creating and activating component configuration as necessary.
- `ComponentInstance` - A ComponentInstance encapsulates a component instance of an activated component configuration.
- `ComponentServiceObjects` - Allows multiple service objects for a service to be obtained.

### 112.12.2 public interface ComponentConstants

Defines standard names for Service Component constants.

*Provider Type* Consumers of this API must not implement this type

#### 112.12.2.1 public static final String COMPONENT\_CAPABILITY\_NAME = "osgi.component"

Capability name for Service Component Runtime.

Used in Provide-Capability and Require-Capability manifest headers with the `osgi.extender` namespace. For example:

```
Require-Capability: osgi.extender;
    filter:="(&(osgi.extender=osgi.component)(version>=1.3)(!(version>=2.0)))"
```

*Since* 1.3

#### 112.12.2.2 public static final String COMPONENT\_FACTORY = "component.factory"

A service registration property for a Component Factory that contains the value of the factory attribute. The value of this property must be of type String.

#### 112.12.2.3 public static final String COMPONENT\_ID = "component.id"

A component property that contains the generated id for a component configuration. The value of this property must be of type Long.

The value of this property is assigned by Service Component Runtime when a component configuration is created. Service Component Runtime assigns a unique value that is larger than all previously assigned values since Service Component Runtime was started. These values are NOT persistent across restarts of Service Component Runtime.

- 112.12.2.4**      **public static final String COMPONENT\_NAME = "component.name"**  
A component property for a component configuration that contains the name of the component as specified in the name attribute of the component element. The value of this property must be of type String.
- 112.12.2.5**      **public static final int DEACTIVATION\_REASON\_BUNDLE\_STOPPED = 6**  
The component configuration was deactivated because the bundle was stopped.  
*Since* 1.1
- 112.12.2.6**      **public static final int DEACTIVATION\_REASON\_CONFIGURATION\_DELETED = 4**  
The component configuration was deactivated because its configuration was deleted.  
*Since* 1.1
- 112.12.2.7**      **public static final int DEACTIVATION\_REASON\_CONFIGURATION\_MODIFIED = 3**  
The component configuration was deactivated because its configuration was changed.  
*Since* 1.1
- 112.12.2.8**      **public static final int DEACTIVATION\_REASON\_DISABLED = 1**  
The component configuration was deactivated because the component was disabled.  
*Since* 1.1
- 112.12.2.9**      **public static final int DEACTIVATION\_REASON\_DISPOSED = 5**  
The component configuration was deactivated because the component was disposed.  
*Since* 1.1
- 112.12.2.10**     **public static final int DEACTIVATION\_REASON\_REFERENCE = 2**  
The component configuration was deactivated because a reference became unsatisfied.  
*Since* 1.1
- 112.12.2.11**     **public static final int DEACTIVATION\_REASON\_UNSPECIFIED = 0**  
The reason the component configuration was deactivated is unspecified.  
*Since* 1.1
- 112.12.2.12**     **public static final String REFERENCE\_TARGET\_SUFFIX = ".target"**  
The suffix for reference target properties. These properties contain the filter to select the target services for a reference. The value of this property must be of type String.
- 112.12.2.13**     **public static final String SERVICE\_COMPONENT = "Service-Component"**  
Manifest header specifying the XML documents within a bundle that contain the bundle's Service Component descriptions.  
The attribute value may be retrieved from the Dictionary object returned by the Bundle.getHeaders method.
- 112.12.3**        **public interface ComponentContext**  
A Component Context object is used by a component instance to interact with its execution context including locating services by reference name. Each component instance has a unique Component Context.

A component instance may obtain its Component Context object through its activate, modified, and deactivate methods.

*Concurrency* Thread-safe

*Provider Type* Consumers of this API must not implement this type

#### 112.12.3.1 **public void disableComponent(String name)**

*name* The name of a component.

- Disables the specified component name. The specified component name must be in the same bundle as this component.

This method must return after changing the enabled state of the specified component name. Any actions that result from this, such as activating or deactivating a component configuration, must occur asynchronously to this method call.

#### 112.12.3.2 **public void enableComponent(String name)**

*name* The name of a component or null to indicate all components in the bundle.

- Enables the specified component name. The specified component name must be in the same bundle as this component.

This method must return after changing the enabled state of the specified component name. Any actions that result from this, such as activating or deactivating a component configuration, must occur asynchronously to this method call.

#### 112.12.3.3 **public BundleContext getBundleContext()**

- Returns the BundleContext of the bundle which contains this component.

*Returns* The BundleContext of the bundle containing this component.

#### 112.12.3.4 **public ComponentInstance getComponentInstance()**

- Returns the Component Instance object for the component instance associated with this Component Context.

*Returns* The Component Instance object for the component instance.

#### 112.12.3.5 **public Dictionary<String, Object> getProperties()**

- Returns the component properties for this Component Context.

*Returns* The properties for this Component Context. The Dictionary is read only and cannot be modified.

#### 112.12.3.6 **public ServiceReference<?> getServiceReference()**

- If the component instance is registered as a service using the service element, then this method returns the service reference of the service provided by this component instance.

This method will return null if the component instance is not registered as a service.

*Returns* The ServiceReference object for the component instance or null if the component instance is not registered as a service.

#### 112.12.3.7 **public Bundle getUsingBundle()**

- If the component instance is registered as a service using the servicescope="bundle" or servicescope="prototype" attribute, then this method returns the bundle using the service provided by the component instance.

This method will return null if:

- The component instance is not a service, then no bundle can be using it as a service.

- The component instance is a service but did not specify the `servicescope="bundle"` or `servicescope="prototype"` attribute, then all bundles using the service provided by the component instance will share the same component instance.
- The service provided by the component instance is not currently being used by any bundle.

*Returns* The bundle using the component instance as a service or null.

#### **112.12.3.8      public Object locateService(String name)**

*name* The name of a reference as specified in a reference element in this component's description.

- Returns the service object for the specified reference name.

If the cardinality of the reference is `0..n` or `1..n` and multiple services are bound to the reference, the service with the highest ranking (as specified in its `Constants.SERVICE_RANKING` property) is returned. If there is a tie in ranking, the service with the lowest service id (as specified in its `Constants.SERVICE_ID` property); that is, the service that was registered first is returned.

*Returns* A service object for the referenced service or null if the reference cardinality is `0..1` or `0..n` and no bound service is available.

*Throws* `ComponentException`— If Service Component Runtime catches an exception while activating the bound service.

#### **112.12.3.9      public S locateService(String name,ServiceReference<S> reference)**

*Type Arguments* <S>

<S> Type of Service.

*name* The name of a reference as specified in a reference element in this component's description.

*reference* The `ServiceReference` to a bound service. This must be a `ServiceReference` provided to the component via the `bind` or `unbind` method for the specified reference name.

- Returns the service object for the specified reference name and `ServiceReference`.

*Returns* A service object for the referenced service or null if the specified `ServiceReference` is not a bound service for the specified reference name.

*Throws* `ComponentException`— If Service Component Runtime catches an exception while activating the bound service.

#### **112.12.3.10     public Object[] locateServices(String name)**

*name* The name of a reference as specified in a reference element in this component's description.

- Returns the service objects for the specified reference name.

*Returns* An array of service objects for the referenced service or null if the reference cardinality is `0..1` or `0..n` and no bound service is available. If the reference cardinality is `0..1` or `1..1` and a bound service is available, the array will have exactly one element.

*Throws* `ComponentException`— If Service Component Runtime catches an exception while activating a bound service.

### **112.12.4      public class ComponentException               extends RuntimeException**

Unchecked exception which may be thrown by Service Component Runtime.

#### **112.12.4.1      public ComponentException(String message,Throwable cause)**

*message* The message for the exception.

*cause* The cause of the exception. May be null.

- Construct a new `ComponentException` with the specified message and cause.

#### 112.12.4.2 **public `ComponentException(String message)`**

*message* The message for the exception.

- Construct a new `ComponentException` with the specified message.

#### 112.12.4.3 **public `ComponentException(Throwable cause)`**

*cause* The cause of the exception. May be null.

- Construct a new `ComponentException` with the specified cause.

#### 112.12.4.4 **public `Throwable getCause()`**

- Returns the cause of this exception or null if no cause was set.

*Returns* The cause of this exception or null if no cause was set.

#### 112.12.4.5 **public `Throwable initCause(Throwable cause)`**

*cause* The cause of this exception.

- Initializes the cause of this exception to the specified value.

*Returns* This exception.

*Throws* `IllegalArgumentException`– If the specified cause is this exception.

`IllegalStateException`– If the cause of this exception has already been set.

### 112.12.5 **public interface `ComponentFactory`**

When a component is declared with the factory attribute on its component element, Service Component Runtime will register a Component Factory service to allow new component configurations to be created and activated rather than automatically creating and activating component configuration as necessary.

*Concurrency* Thread-safe

*Provider Type* Consumers of this API must not implement this type

#### 112.12.5.1 **public `ComponentInstance newInstance(Dictionary<String,?> properties)`**

*properties* Additional properties for the component configuration or null if there are no additional properties.

- Create and activate a new component configuration. Additional properties may be provided for the component configuration.

*Returns* A `ComponentInstance` object encapsulating the component instance of the component configuration. The component configuration has been activated and, if the component specifies a service element, the component instance has been registered as a service.

*Throws* `ComponentException`– If Service Component Runtime is unable to activate the component configuration.

### 112.12.6 **public interface `ComponentInstance`**

A `ComponentInstance` encapsulates a component instance of an activated component configuration. `ComponentInstances` are created whenever a component configuration is activated.

`ComponentInstances` are never reused. A new `ComponentInstance` object will be created when the component configuration is activated again.

*Concurrency* Thread-safe

*Provider Type* Consumers of this API must not implement this type

#### 112.12.6.1 **public void dispose()**

- Dispose of the component configuration for this component instance. The component configuration will be deactivated. If the component configuration has already been deactivated, this method does nothing.

#### 112.12.6.2 **public Object getInstance()**

- Returns the component instance of the activated component configuration.

*Returns* The component instance or null if the component configuration has been deactivated.

### 112.12.7 **public interface ComponentServiceObjects<S>**

<S> Type of Service

Allows multiple service objects for a service to be obtained.

A component instance can receive a ComponentServiceObjects object via a reference that is typed ComponentServiceObjects.

For services with prototype scope, multiple service objects for the service can be obtained. For services with singleton or bundle scope, only one, use-counted service object is available.

Any unreleased service objects obtained from this ComponentServiceObjects object are automatically released by Service Component Runtime when the service becomes unbound.

*See Also* ServiceObjects

*Since* 1.3

*Concurrency* Thread-safe

*Provider Type* Consumers of this API must not implement this type

#### 112.12.7.1 **public S getService()**

- Returns a service object for the associated service.

This method will always return null when the associated service has been become unbound.

*Returns* A service object for the associated service or null if the service is unbound, the customized service object returned by a ServiceFactory does not implement the classes under which it was registered or the ServiceFactory threw an exception.

*Throws* IllegalStateException– If the associated service has been become unbound.

*See Also* ungetService(Object)

#### 112.12.7.2 **public ServiceReference<S> getServiceReference()**

- Returns the ServiceReference for the service associated with this ComponentServiceObjects object.

*Returns* The ServiceReference for the service associated with this ComponentServiceObjects object.

#### 112.12.7.3 **public void ungetService(S service)**

*service* A service object previously provided by this ComponentServiceObjects object.

- Releases a service object for the associated service.

The specified service object must no longer be used and all references to it should be destroyed after calling this method.

*Throws* IllegalStateException– If the associated service has been become unbound.

IllegalArgumentException– If the specified service object was not provided by this ComponentServiceObjects object.

*See Also* getService()

## 112.13 org.osgi.service.component.annotations

Service Component Annotations Package Version 1.3.

This package is not used at runtime. Annotated classes are processed by tools to generate Component Descriptions which are used at runtime.

### 112.13.1 Summary

- `Activate` - Identify the annotated method as the `activate` method of a Service Component.
- `Component` - Identify the annotated class as a Service Component.
- `ConfigurationPolicy` - Configuration Policy for the Component annotation.
- `Deactivate` - Identify the annotated method as the `deactivate` method of a Service Component.
- `FieldOption` - Field options for the Reference annotation.
- `Modified` - Identify the annotated method as the `modified` method of a Service Component.
- `Reference` - Identify the annotated member as a reference of a Service Component.
- `ReferenceCardinality` - Cardinality for the Reference annotation.
- `ReferencePolicy` - Policy for the Reference annotation.
- `ReferencePolicyOption` - Policy option for the Reference annotation.
- `ReferenceScope` - Reference scope for the Reference annotation.
- `ServiceScope` - Service scope for the Component annotation.

### 112.13.2 @Activate

Identify the annotated method as the `activate` method of a Service Component.

The annotated method is the `activate` method of the Component.

This annotation is not processed at runtime by Service Component Runtime. It must be processed by tools and used to add a Component Description to the bundle.

*See Also* The `activate` attribute of the component element of a Component Description.

*Since* 1.1

*Retention* CLASS

*Target* METHOD

### 112.13.3 @Component

Identify the annotated class as a Service Component.

The annotated class is the implementation class of the Component.

This annotation is not processed at runtime by Service Component Runtime. It must be processed by tools and used to add a Component Description to the bundle.

*See Also* The component element of a Component Description.

*Retention* CLASS

*Target* TYPE

#### 112.13.3.1 String name default ""

- The name of this Component.



If not specified, the name of this Component is the fully qualified type name of the class being annotated.

*See Also* The name attribute of the component element of a Component Description.

#### 112.13.3.2 **Class<?>[] service default {}**

- The types under which to register this Component as a service.

If no service should be registered, the empty value {} must be specified.

If not specified, the service types for this Component are all the *directly* implemented interfaces of the class being annotated.

*See Also* The service element of a Component Description.

#### 112.13.3.3 **String factory default ""**

- The factory identifier of this Component. Specifying a factory identifier makes this Component a Factory Component.

If not specified, the default is that this Component is not a Factory Component.

*See Also* The factory attribute of the component element of a Component Description.

#### 112.13.3.4 **boolean servicefactory default false**

- Declares whether this Component uses the OSGi ServiceFactory concept and each bundle using this Component's service will receive a different component instance.

This element is ignored when the scope() element does not have the default value. If true, this Component uses bundle service scope. If false or not specified, this Component uses singleton service scope. If the factory() element is specified or the immediate() element is specified with true, this element can only be specified with false.

*See Also* The scope attribute of the service element of a Component Description.

*Deprecated* Since 1.3. Replaced by scope().

#### 112.13.3.5 **boolean enabled default true**

- Declares whether this Component is enabled when the bundle containing it is started.

If true or not specified, this Component is enabled. If false, this Component is disabled.

*See Also* The enabled attribute of the component element of a Component Description.

#### 112.13.3.6 **boolean immediate default false**

- Declares whether this Component must be immediately activated upon becoming satisfied or whether activation should be delayed.

If true, this Component must be immediately activated upon becoming satisfied. If false, activation of this Component is delayed. If this property is specified, its value must be false if the factory() property is also specified or must be true if the service() property is specified with an empty value.

If not specified, the default is false if the factory() property is specified or the service() property is not specified or specified with a non-empty value and true otherwise.

*See Also* The immediate attribute of the component element of a Component Description.

#### 112.13.3.7 **String[] property default {}**

- Properties for this Component.

Each property string is specified as "name=value". The type of the property value can be specified in the name as name:type=value. The type must be one of the property types supported by the type attribute of the property element of a Component Description.

To specify a property with multiple values, use multiple name, value pairs. For example, "foo=bar", "foo=baz".

*See Also* The property element of a Component Description.

#### 112.13.3.8 **String[] properties default {}**

- Property entries for this Component.

Specifies the name of an entry in the bundle whose contents conform to a standard Java Properties File. The entry is read and processed to obtain the properties and their values.

*See Also* The properties element of a Component Description.

#### 112.13.3.9 **String xmlns default ""**

- The XML name space of the Component Description for this Component.

If not specified, the XML name space of the Component Description for this Component should be the lowest Declarative Services XML name space which supports all the specification features used by this Component.

*See Also* The XML name space specified for a Component Description.

#### 112.13.3.10 **ConfigurationPolicy configurationPolicy default OPTIONAL**

- The configuration policy of this Component.

Controls whether component configurations must be satisfied depending on the presence of a corresponding Configuration object in the OSGi Configuration Admin service. A corresponding configuration is a Configuration object where the PID equals the name of the component.

If not specified, the configuration policy is based upon whether the component is also annotated with the Meta Type Designate annotation.

- Not annotated with Designate - The configuration policy is OPTIONAL.
- Annotated with Designate(factory=false) - The configuration policy is OPTIONAL.
- Annotated with Designate(factory=true) - The configuration policy is REQUIRE.

*See Also* The configuration-policy attribute of the component element of a Component Description.

*Since* 1.1

#### 112.13.3.11 **String[] configurationPid default "\$"**

- The configuration PIDs for the configuration of this Component.

Each value specifies a configuration PID for this Component.

If no value is specified, the name of this Component is used as the configuration PID of this Component.

A special string("\$") can be used to specify the name of the component as a configuration PID. The NAME constant holds this special string. For example:

```
@Component(configurationPid={"com.acme.system", Component.NAME})
```

Tools creating a Component Description from this annotation must replace the special string with the actual name of this Component.

*See Also* The configuration-pid attribute of the component element of a Component Description.

*Since* 1.2

#### 112.13.3.12 **ServiceScope scope default DEFAULT**

- The service scope for the service of this Component.

If not specified (and the deprecated `servicefactory()` element is not specified), the singleton service scope is used. If the `factory()` element is specified or the `immediate()` element is specified with `true`, this element can only be specified with the singleton service scope.

*See Also* The scope attribute of the service element of a Component Description.

*Since* 1.3

### 112.13.3.13 **Reference[] reference default**

- The lookup strategy references of this Component.

To access references using the lookup strategy, Reference annotations are specified naming the reference and declaring the type of the referenced service. The referenced service can be accessed using one of the `locateService` methods of `ComponentContext`.

To access references using the event strategy, bind methods are annotated with Reference. To access references using the field strategy, fields are annotated with Reference.

*See Also* The reference element of a Component Description.

*Since* 1.3

### 112.13.3.14 **String NAME = "\$"**

Special string representing the name of this Component.

This string can be used in `configurationPid()` to specify the name of the component as a configuration PID. For example:

```
@Component(configurationPid={"com.acme.system", Component.NAME})
```

Tools creating a Component Description from this annotation must replace the special string with the actual name of this Component.

*Since* 1.3

## 112.13.4 **enum ConfigurationPolicy**

Configuration Policy for the Component annotation.

Controls whether component configurations must be satisfied depending on the presence of a corresponding Configuration object in the OSGi Configuration Admin service. A corresponding configuration is a Configuration object where the PID is the name of the component.

*Since* 1.1

### 112.13.4.1 **OPTIONAL**

Use the corresponding Configuration object if present but allow the component to be satisfied even if the corresponding Configuration object is not present.

### 112.13.4.2 **REQUIRE**

There must be a corresponding Configuration object for the component configuration to become satisfied.

### 112.13.4.3 **IGNORE**

Always allow the component configuration to be satisfied and do not use the corresponding Configuration object even if it is present.

## 112.13.5 **@Deactivate**

Identify the annotated method as the `deactivate` method of a Service Component.

The annotated method is the `deactivate` method of the Component.

This annotation is not processed at runtime by Service Component Runtime. It must be processed by tools and used to add a Component Description to the bundle.

*See Also* The deactivate attribute of the component element of a Component Description.

*Since* 1.1

*Retention* CLASS

*Target* METHOD

### 112.13.6 enum FieldOption

Field options for the Reference annotation.

*Since* 1.3

#### 112.13.6.1 UPDATE

The update field option is used to update the collection referenced by the field when there are changes to the bound services.

This field option can only be used when the field reference has dynamic policy and multiple cardinality.

#### 112.13.6.2 REPLACE

The replace field option is used to replace the field value with a new value when there are changes to the bound services.

### 112.13.7 @Modified

Identify the annotated method as the modified method of a Service Component.

The annotated method is the modified method of the Component.

This annotation is not processed at runtime by Service Component Runtime. It must be processed by tools and used to add a Component Description to the bundle.

*See Also* The modified attribute of the component element of a Component Description.

*Since* 1.1

*Retention* CLASS

*Target* METHOD

### 112.13.8 @Reference

Identify the annotated member as a reference of a Service Component.

When the annotation is applied to a method, the method is the bind method of the reference. When the annotation is applied to a field, the field will contain the bound service(s) of the reference.

This annotation is not processed at runtime by Service Component Runtime. It must be processed by tools and used to add a Component Description to the bundle.

In the generated Component Description for a component, the references must be ordered in ascending lexicographical order (using `String.compareTo`) of the reference names.

*See Also* The reference element of a Component Description.

*Retention* CLASS

*Target* METHOD, FIELD

#### 112.13.8.1 String name default ""

- The name of this reference.

The name of this reference must be specified when using this annotation in the `Component.reference()` element since there is no annotated member from which the name can be determined. If not specified, the name of this reference is based upon how this annotation is used:

- Annotated method - If the method name begins with `bind`, `set` or `add`, that prefix is removed to create the name of the reference. Otherwise, the name of the reference is the method name.
- Annotated field - The name of the reference is the field name.

*See Also* The name attribute of the reference element of a Component Description.

#### 112.13.8.2 **Class<?> service default Object.class**

- The type of the service for this reference.

The type of the service for this reference must be specified when using this annotation in the `Component.reference()` element since there is no annotated member from which the type of the service can be determined.

If not specified, the type of the service for this reference is based upon how this annotation is used:

- Annotated method - The type of the service is the type of the first argument of the method.
- Annotated field - The type of the service is based upon the type of the field being annotated and the cardinality of the reference. If the cardinality is either `0..n`, or `1..n`, the type of the field must be one of `java.util.Collection`, `java.util.List`, or a subtype of `java.util.Collection` so the type of the service is the generic type of the collection. Otherwise, the type of the service is the type of the field.

*See Also* The interface attribute of the reference element of a Component Description.

#### 112.13.8.3 **ReferenceCardinality cardinality default MANDATORY**

- The cardinality of this reference.

If not specified, the cardinality of this reference is based upon how this annotation is used:

- Annotated method - The cardinality is `1..1`.
- Annotated field - The cardinality is based on the type of the field. If the type is either `java.util.Collection`, `java.util.List`, or a subtype of `java.util.Collection`, the cardinality is `0..n`. Otherwise the cardinality is `1..1`.
- `Component.reference()` element - The cardinality is `1..1`.

*See Also* The cardinality attribute of the reference element of a Component Description.

#### 112.13.8.4 **ReferencePolicy policy default STATIC**

- The policy for this reference.

If not specified, the policy of this reference is based upon how this annotation is used:

- Annotated method - The policy is `STATIC`.
- Annotated field - The policy is based on the modifiers of the field. If the field is declared `volatile`, the policy is `ReferencePolicy.DYNAMIC`. Otherwise the policy is `STATIC`.
- `Component.reference()` element - The policy is `STATIC`.

*See Also* The policy attribute of the reference element of a Component Description.

#### 112.13.8.5 **String target default ""**

- The target property for this reference.

If not specified, no target property is set.

*See Also* The target attribute of the reference element of a Component Description.

**112.13.8.6 ReferencePolicyOption policyOption default RELUCTANT**

- The policy option for this reference.  
If not specified, the RELUCTANT reference policy option is used.

*See Also* The policy-option attribute of the reference element of a Component Description.

*Since* 1.2

**112.13.8.7 ReferenceScope scope default BUNDLE**

- The reference scope for this reference.  
If not specified, the bundle reference scope is used.

*See Also* The scope attribute of the reference element of a Component Description.

*Since* 1.3

**112.13.8.8 String bind default ""**

- The name of the bind method for this reference.  
If specified and this reference annotates a method, the specified name must match the name of the annotated method.

If not specified, the name of the bind method is based upon how this annotation is used:

- Annotated method - The name of the annotated method is the name of the bind method.
- Annotated field - There is no bind method name.
- Component.reference() element - There is no bind method name.

If there is a bind method name, the component must contain a method with that name.

*See Also* The bind attribute of the reference element of a Component Description.

*Since* 1.3

**112.13.8.9 String updated default ""**

- The name of the updated method for this reference.

If not specified, the name of the updated method is based upon how this annotation is used:

- Annotated method - The name of the updated method is created from the name of the annotated method. If the name of the annotated method begins with bind, set or add, that prefix is replaced with updated to create the name candidate for the updated method. Otherwise, updated is prefixed to the name of the annotated method to create the name candidate for the updated method. If the component type contains a method with the candidate name, the candidate name is used as the name of the updated method. To declare no updated method when the component type contains a method with the candidate name, the value "-" must be used.
- Annotated field - There is no updated method name.
- Component.reference() element - There is no updated method name.

If there is an updated method name, the component must contain a method with that name.

*See Also* The updated attribute of the reference element of a Component Description.

*Since* 1.2

**112.13.8.10 String unbind default ""**

- The name of the unbind method for this reference.

If not specified, the name of the unbind method is based upon how this annotation is used:

- Annotated method - The name of the unbind method is created from the name of the annotated method. If the name of the annotated method begins with bind, set or add, that prefix is replaced with unbind, unset or remove, respectively, to create the name candidate for the unbind method. Otherwise, un is prefixed to the name of the annotated method to create the name candidate for the unbind method. If the component type contains a method with the candidate name, the candidate name is used as the name of the unbind method. To declare no unbind method when the component type contains a method with the candidate name, the value "-" must be used.
- Annotated field - There is no unbind method name.
- Component.reference() element - There is no unbind method name.

If there is an unbind method name, the component must contain a method with that name.

*See Also* The unbind attribute of the reference element of a Component Description.

#### 112.13.8.11 String field default ""

- The name of the field for this reference.

If specified and this reference annotates a field, the specified name must match the name of the annotated field.

If not specified, the name of the field is based upon how this annotation is used:

- Annotated method - There is no field name.
- Annotated field - The name of the annotated field is the name of the field.
- Component.reference() element - There is no field name.

If there is a field name, the component must contain a field with that name.

*See Also* The field attribute of the reference element of a Component Description.

*Since* 1.3

#### 112.13.8.12 FieldOption fieldOption default REPLACE

- The field option for this reference.

If not specified, the field option is based upon how this annotation is used:

- Annotated method - There is no field option.
- Annotated field - The field option is based upon the policy and cardinality of the reference and the modifiers of the field. If the policy is ReferencePolicy.DYNAMIC, the cardinality is 0..n or 1..n, and the field is declared final, the field option is FieldOption.UPDATE. Otherwise, the field option is FieldOption.REPLACE
- Component.reference() element - There is no field option.

*See Also* The field-option attribute of the reference element of a Component Description.

*Since* 1.3

### 112.13.9 enum ReferenceCardinality

Cardinality for the Reference annotation.

Specifies if the reference is optional and if the component implementation support a single bound service or multiple bound services.

#### 112.13.9.1 OPTIONAL

The reference is optional and unary. That is, the reference has a cardinality of 0..1.

#### 112.13.9.2 MANDATORY

The reference is mandatory and unary. That is, the reference has a cardinality of 1..1.

**112.13.9.3 MULTIPLE**

The reference is optional and multiple. That is, the reference has a cardinality of 0..n.

**112.13.9.4 AT\_LEAST\_ONE**

The reference is mandatory and multiple. That is, the reference has a cardinality of 1..n.

**112.13.10 enum ReferencePolicy**

Policy for the Reference annotation.

**112.13.10.1 STATIC**

The static policy is the most simple policy and is the default policy. A component instance never sees any of the dynamics. Component configurations are deactivated before any bound service for a reference having a static policy becomes unavailable. If a target service is available to replace the bound service which became unavailable, the component configuration must be reactivated and bound to the replacement service.

**112.13.10.2 DYNAMIC**

The dynamic policy is slightly more complex since the component implementation must properly handle changes in the set of bound services. With the dynamic policy, SCR can change the set of bound services without deactivating a component configuration. If the component uses the event strategy to access services, then the component instance will be notified of changes in the set of bound services by calls to the bind and unbind methods.

**112.13.11 enum ReferencePolicyOption**

Policy option for the Reference annotation.

*Since* 1.2

**112.13.11.1 RELUCTANT**

The reluctant policy option is the default policy option for both static and dynamic reference policies. When a new target service for a reference becomes available, references having the reluctant policy option for the static policy or the dynamic policy with a unary cardinality will ignore the new target service. References having the dynamic policy with a multiple cardinality will bind the new target service.

**112.13.11.2 GREEDY**

The greedy policy option is a valid policy option for both static and dynamic reference policies. When a new target service for a reference becomes available, references having the greedy policy option will bind the new target service.

**112.13.12 enum ReferenceScope**

Reference scope for the Reference annotation.

*Since* 1.3

**112.13.12.1 BUNDLE**

A single service object is used for all references to the service in this bundle.

**112.13.12.2 PROTOTYPE**

If the bound service has prototype service scope, then each instance of the component with this reference can receive a unique instance of the service. If the bound service does not have prototype service scope, then this reference scope behaves the same as BUNDLE.



**112.13.12.3****PROTOTYPE\_REQUIRED**

Bound services must have prototype service scope. Each instance of the component with this reference can receive a unique instance of the service.

**112.13.13****enum ServiceScope**

Service scope for the Component annotation.

*Since* 1.3

**112.13.13.1****SINGLETON**

When the component is registered as a service, it must be registered as a bundle scope service but only a single instance of the component must be used for all bundles using the service.

**112.13.13.2****BUNDLE**

When the component is registered as a service, it must be registered as a bundle scope service and an instance of the component must be created for each bundle using the service.

**112.13.13.3****PROTOTYPE**

When the component is registered as a service, it must be registered as a prototype scope service and an instance of the component must be created for each distinct request for the service.

**112.13.13.4****DEFAULT**

Default element value for annotation. This is used to distinguish the default value for an element and should not otherwise be used.

**112.14****org.osgi.service.component.runtime**

Service Component Runtime Package Version 1.3.

Bundles wishing to use this package must list the package in the Import-Package header of the bundle's manifest. This package has two types of users: the consumers that use the API in this package and the providers that implement the API in this package.

Example import for consumers using the API in this package:

```
Import-Package: org.osgi.service.component.runtime; version="[1.3,2.0)"
```

Example import for providers implementing the API in this package:

```
Import-Package: org.osgi.service.component.runtime; version="[1.3,1.4)"
```

**112.14.1****Summary**

- `ServiceComponentRuntime` - The `ServiceComponentRuntime` service represents the Declarative Services actor, known as Service Component Runtime (SCR), that manages the service components and their life cycle.

**112.14.2****public interface ServiceComponentRuntime**

The `ServiceComponentRuntime` service represents the Declarative Services actor, known as Service Component Runtime (SCR), that manages the service components and their life cycle. The `ServiceComponentRuntime` service allows introspection of the components managed by Service Component Runtime.

This service differentiates between a `ComponentDescriptionDTO` and a `ComponentConfigurationDTO`. A `ComponentDescriptionDTO` is a representation of a declared component description. A

ComponentConfigurationDTO is a representation of an actual instance of a declared component description parameterized by component properties.

Access to this service requires the ServicePermission[ServiceComponentRuntime, GET] permission. It is intended that only administrative bundles should be granted this permission to limit access to the potentially intrusive methods provided by this service.

*Since* 1.3

*Concurrency* Thread-safe

*Provider Type* Consumers of this API must not implement this type

#### **112.14.2.1 public Promise<Void> disableComponent(ComponentDescriptionDTO description)**

*description* The component description to disable. Must not be null.

- Disables the specified component description.

If the specified component description is currently disabled, this method has no effect.

This method must return after changing the enabled state of the specified component description. Any actions that result from this, such as activating or deactivating a component configuration, must occur asynchronously to this method call.

*Returns* A promise that will be resolved when the actions that result from changing the enabled state of the specified component have completed.

*See Also* isEnabled(ComponentDescriptionDTO)

#### **112.14.2.2 public Promise<Void> enableComponent(ComponentDescriptionDTO description)**

*description* The component description to enable. Must not be null.

- Enables the specified component description.

If the specified component description is currently enabled, this method has no effect.

This method must return after changing the enabled state of the specified component description. Any actions that result from this, such as activating or deactivating a component configuration, must occur asynchronously to this method call.

*Returns* A promise that will be resolved when the actions that result from changing the enabled state of the specified component have completed.

*See Also* isEnabled(ComponentDescriptionDTO)

#### **112.14.2.3 public Collection<ComponentConfigurationDTO> getComponentConfigurationDTOs(ComponentDescriptionDTO description)**

*description* The component description. Must not be null.

- Returns the component configurations for the specified component description.

*Returns* A collection containing a snapshot of the current component configurations for the specified component description. An empty collection is returned if there are none.

#### **112.14.2.4 public ComponentDescriptionDTO getComponentDescriptionDTO(Bundle bundle, String name)**

*bundle* The bundle declaring the component description. Must not be null.

*name* The name of the component description. Must not be null.

- Returns the ComponentDescriptionDTO declared with the specified name by the specified bundle.

Only component descriptions from active bundles are returned. null if no such component is declared by the given bundle or the bundle is not active.

*Returns* The declared component description or null if the specified bundle is not active or does not declare a component description with the specified name.

#### 112.14.2.5 **public Collection<ComponentDescriptionDTO> getComponentDescriptionDTOs(Bundle ... bundles)**

*bundles* The bundles whose declared component descriptions are to be returned. Specifying no bundles, or the equivalent of an empty Bundle array, will return the declared component descriptions from all active bundles.

- Returns the component descriptions declared by the specified active bundles.

Only component descriptions from active bundles are returned. If the specified bundles have no declared components or are not active, an empty collection is returned.

*Returns* The declared component descriptions of the specified active bundles. An empty collection is returned if there are no component descriptions for the specified active bundles.

#### 112.14.2.6 **public boolean isComponentEnabled(ComponentDescriptionDTO description)**

*description* The component description. Must not be null.

- Returns whether the specified component description is currently enabled.

The enabled state of a component description is initially set by the enabled attribute of the component description.

*Returns* true if the specified component description is currently enabled. Otherwise, false.

*See Also* enableComponent(ComponentDescriptionDTO), disableComponent(ComponentDescriptionDTO), ComponentContext.disableComponent(String), ComponentContext.enableComponent(String)

## 112.15 **org.osgi.service.component.runtime.dto**

Service Component Runtime Data Transfer Objects Package Version 1.3.

Bundles wishing to use this package must list the package in the Import-Package header of the bundle's manifest. This package has two types of users: the consumers that use the API in this package and the providers that implement the API in this package.

Example import for consumers using the API in this package:

```
Import-Package: org.osgi.service.component.runtime.dto; version="[1.3,2.0)"
```

Example import for providers implementing the API in this package:

```
Import-Package: org.osgi.service.component.runtime.dto; version="[1.3,1.4)"
```

### 112.15.1 **Summary**

- ComponentConfigurationDTO - A representation of an actual instance of a declared component description parameterized by component properties.
- ComponentDescriptionDTO - A representation of a declared component description.
- ReferenceDTO - A representation of a declared reference to a service.
- SatisfiedReferenceDTO - A representation of a satisfied reference.
- UnsatisfiedReferenceDTO - A representation of an unsatisfied reference.

### 112.15.2 **public class ComponentConfigurationDTO extends DTO**

A representation of an actual instance of a declared component description parameterized by component properties.

*Since* 1.3

*Concurrency* Not Thread-safe

**112.15.2.1 public static final int ACTIVE = 8**

The component configuration is active.

This is the normal operational state of a component configuration.

**112.15.2.2 public ComponentDescriptionDTO description**

The representation of the component configuration's component description.

**112.15.2.3 public long id**

The id of the component configuration.

The id is a non-persistent, unique value assigned at runtime. The id is also available as the `component.id` component property. The value of this field is unspecified if the state of this component configuration is unsatisfied.

**112.15.2.4 public Map<String, Object> properties**

The component properties for the component configuration.

*See Also* `ComponentContext.getProperties()`

**112.15.2.5 public static final int SATISFIED = 4**

The component configuration is satisfied.

Any services declared by the component description are registered.

**112.15.2.6 public SatisfiedReferenceDTO[] satisfiedReferences**

The satisfied references.

Each `SatisfiedReferenceDTO` in the array represents a satisfied reference of the component configuration. The array must be empty if the component configuration has no satisfied references.

**112.15.2.7 public int state**

The current state of the component configuration.

This is one of `UNSATISFIED_CONFIGURATION`, `UNSATISFIED_REFERENCE`, `SATISFIED` or `ACTIVE`.

**112.15.2.8 public static final int UNSATISFIED\_CONFIGURATION = 1**

The component configuration is unsatisfied due to a missing required configuration.

**112.15.2.9 public static final int UNSATISFIED\_REFERENCE = 2**

The component configuration is unsatisfied due to an unsatisfied reference.

**112.15.2.10 public UnsatisfiedReferenceDTO[] unsatisfiedReferences**

The unsatisfied references.

Each `UnsatisfiedReferenceDTO` in the array represents an unsatisfied reference of the component configuration. The array must be empty if the component configuration has no unsatisfied references.

**112.15.2.11 public ComponentConfigurationDTO()**

**112.15.3 public class ComponentDescriptionDTO  
extends DTO**

A representation of a declared component description.

*Since* 1.3

*Concurrency* Not Thread-safe

**112.15.3.1 public String activate**

The name of the activate method.

This is declared in the activate attribute of the component element. This must be null if the component description does not declare an activate method name.

**112.15.3.2 public BundleDTO bundle**

The bundle declaring the component description.

**112.15.3.3 public String[] configurationPid**

The configuration pids.

These are declared in the configuration-pid attribute of the component element. This must contain the default configuration pid if the component description does not declare a configuration pid.

**112.15.3.4 public String configurationPolicy**

The configuration policy.

This is declared in the configuration-policy attribute of the component element. This must be the default configuration policy if the component description does not declare a configuration policy.

**112.15.3.5 public String deactivate**

The name of the deactivate method.

This is declared in the deactivate attribute of the component element. This must be null if the component description does not declare a deactivate method name.

**112.15.3.6 public boolean defaultEnabled**

The initial enabled state.

This is declared in the enabled attribute of the component element.

**112.15.3.7 public String factory**

The component factory name.

This is declared in the factory attribute of the component element. This must be null if the component description is not declared as a component factory.

**112.15.3.8 public boolean immediate**

The immediate state.

This is declared in the immediate attribute of the component element.

**112.15.3.9 public String implementationClass**

The fully qualified name of the implementation class.

This is declared in the class attribute of the implementation element.

**112.15.3.10 public String modified**

The name of the modified method.

This is declared in the modified attribute of the component element. This must be null if the component description does not declare a modified method name.

**112.15.3.11****public String name**

The name of the component.

This is declared in the name attribute of the component element. This must be the default name if the component description does not declare a name.

**112.15.3.12****public Map<String, Object> properties**

The declared component properties.

These are declared in the property and properties elements.

**112.15.3.13****public ReferenceDTO[] references**

The referenced services.

These are declared in the reference elements. The array must be empty if the component description does not declare references to any services.

**112.15.3.14****public String scope**

The service scope.

This is declared in the scope attribute of the service element. This must be null if the component description does not declare any service interfaces.

**112.15.3.15****public String[] serviceInterfaces**

The fully qualified names of the service interfaces.

These are declared in the interface attribute of the provide elements. The array must be empty if the component description does not declare any service interfaces.

**112.15.3.16****public ComponentDescriptionDTO()****112.15.4****public class ReferenceDTO  
extends DTO**

A representation of a declared reference to a service.

*Since* 1.3

*Concurrency* Not Thread-safe

**112.15.4.1****public String bind**

The name of the bind method of the reference.

This is declared in the bind attribute of the reference element. This must be null if the component description does not declare a bind method for the reference.

**112.15.4.2****public String cardinality**

The cardinality of the reference.

This is declared in the cardinality attribute of the reference element. This must be the default cardinality if the component description does not declare a cardinality for the reference.

**112.15.4.3****public String field**

The name of the field of the reference.

---

This is declared in the field attribute of the reference element. This must be null if the component description does not declare a field for the reference.

**112.15.4.4****public String fieldOption**

The field option of the reference.

This is declared in the field-option attribute of the reference element. This must be null if the component description does not declare a field for the reference.

**112.15.4.5****public String interfaceName**

The service interface of the reference.

This is declared in the interface attribute of the reference element.

**112.15.4.6****public String name**

The name of the reference.

This is declared in the name attribute of the reference element. This must be the default name if the component description does not declare a name for the reference.

**112.15.4.7****public String policy**

The policy of the reference.

This is declared in the policy attribute of the reference element. This must be the default policy if the component description does not declare a policy for the reference.

**112.15.4.8****public String policyOption**

The policy option of the reference.

This is declared in the policy-option attribute of the reference element. This must be the default policy option if the component description does not declare a policy option for the reference.

**112.15.4.9****public String scope**

The scope of the reference.

This is declared in the scope attribute of the reference element. This must be the default scope if the component description does not declare a scope for the reference.

**112.15.4.10****public String target**

The target of the reference.

This is declared in the target attribute of the reference element. This must be null if the component description does not declare a target for the reference.

**112.15.4.11****public String unbind**

The name of the unbind method of the reference.

This is declared in the unbind attribute of the reference element. This must be null if the component description does not declare an unbind method for the reference.

**112.15.4.12****public String updated**

The name of the updated method of the reference.

This is declared in the updated attribute of the reference element. This must be null if the component description does not declare an updated method for the reference.

**112.15.4.13****public ReferenceDTO()**

## 112.15.5 **public class SatisfiedReferenceDTO** **extends DTO**

A representation of a satisfied reference.

*Since* 1.3

*Concurrency* Not Thread-safe

### 112.15.5.1 **public ServiceReferenceDTO[] boundServices**

The bound services.

Each ServiceReferenceDTO in the array represents a service bound to the satisfied reference. The array must be empty if there are no bound services.

### 112.15.5.2 **public String name**

The name of the declared reference.

This is declared in the name attribute of the reference element of the component description.

*See Also* ReferenceDTO.name

### 112.15.5.3 **public String target**

The target property of the satisfied reference.

This is the value of the component property whose name is the concatenation of the declared reference name and ".target". This must be null if no target property is set for the reference.

### 112.15.5.4 **public SatisfiedReferenceDTO()**

## 112.15.6 **public class UnsatisfiedReferenceDTO** **extends DTO**

A representation of an unsatisfied reference.

*Since* 1.3

*Concurrency* Not Thread-safe

### 112.15.6.1 **public String name**

The name of the declared reference.

This is declared in the name attribute of the reference element of the component description.

*See Also* ReferenceDTO.name

### 112.15.6.2 **public String target**

The target property of the unsatisfied reference.

This is the value of the component property whose name is the concatenation of the declared reference name and ".target". This must be null if no target property is set for the reference.

### 112.15.6.3 **public ServiceReferenceDTO[] targetServices**

The target services.

Each ServiceReferenceDTO in the array represents a target service for the reference. The array must be empty if there are no target services. The upper bound on the number of target services in the array is the upper bound on the cardinality of the reference.

### 112.15.6.4 **public UnsatisfiedReferenceDTO()**



## 112.16 References

- [1] *Automating Service Dependency Management in a Service-Oriented Component Model*  
Humberto Cervantes, Richard S. Hall, Proceedings of the Sixth Component-Based Software Engineering Workshop, May 2003, pp. 91-96  
<http://www-adele.imag.fr/Les.Publications/intConferences/CBSE2003Cer.pdf>
- [2] *Service Binder*  
Humberto Cervantes, Richard S. Hall  
<http://gravity.sourceforge.net/servicebinder>
- [3] *Java Properties File*  
<http://docs.oracle.com/javase/7/docs/api/java/util/Properties.html>
- [4] *Extensible Markup Language (XML) 1.0*  
<http://www.w3.org/TR/REC-xml/>
- [5] *OSGi XML Schemas*  
<http://www.osgi.org/Specifications>

## 112.17 Changes

- *Configuration Changes* on page 326 has been rewritten to more accurately state the effects of configuration changes on component configurations.
- New introspection API. See *Introspection* on page 334.
- Defined capabilities SCR must provide. See *Capabilities* on page 336.
- Expanded the allowed signatures and argument types for Event Methods. See *Event Methods* on page 295.
- New scope attribute for the service element. See *Service Element* on page 311.
- New scope attribute for the reference element. See *Reference Scope* on page 301.
- New reference element for Component annotation. See *Reference Element* on page 312.
- New minimum cardinality property. See *Minimum Cardinality Property* on page 325.
- Added support for a component using multiple configuration PIDs. See *Component Element* on page 307, *Component Properties* on page 324, and *Deployment* on page 325.
- `service.pid` property values are aggregated across configuration sources. See *Component Properties* on page 324.
- SCR must check `ConfigurationPermission` for multi-location Configurations. See *Configuration Multi-Locations and Regions* on page 338.
- Added support for targeted PIDs for Configurations. See *Deployment* on page 325.
- New component property types can be used for type safe component property definition and access. See *Component Property Types* on page 330.
- Specified the ordering of property information component descriptions generated from annotations. See *Ordering of Generated Properties* on page 332.
- Maps of service properties must also implement `Comparable`. See *Event Methods* on page 295.
- Support for field strategy is added. See *Field Strategy* on page 298. This change affects many areas of this specification.



# 113 Event Admin Service Specification

## Version 1.3

### 113.1 Introduction

Nearly all the bundles in an OSGi framework must deal with events, either as an event publisher or as an event handler. So far, the preferred mechanism to disperse those events have been the service interface mechanism.

Dispatching events for a design related to X, usually involves a service of type XListener. However, this model does not scale well for fine grained events that must be dispatched to many different handlers. Additionally, the dynamic nature of the OSGi environment introduces several complexities because both event publishers and event handlers can appear and disappear at any time.

The Event Admin service provides an inter-bundle communication mechanism. It is based on a event *publish* and *subscribe* model, popular in many message based systems.

This specification defines the details for the participants in this event model.

#### 113.1.1 Essentials

- *Simplifications* - The model must significantly simplify the process of programming an event source and an event handler.
- *Dependencies* - Handle the myriad of dependencies between event sources and event handlers for proper cleanup.
- *Synchronicity* - It must be possible to deliver events asynchronously or synchronously with the caller.
- *Event Window* - Only event handlers that are active when an event is published must receive this event, handlers that register later must not see the event.
- *Performance* - The event mechanism must impose minimal overhead in delivering events.
- *Selectivity* - Event listeners must only receive notifications for the event types for which they are interested
- *Reliability* - The Event Admin must ensure that events continue to be delivered regardless the quality of the event handlers.
- *Security* - Publishing and receiving events are sensitive operations that must be protected per event type.
- *Extensibility* - It must be possible to define new event types with their own data types.
- *Native Code* - Events must be able to be passed to native code or come from native code.
- *OSGi Events* - The OSGi Framework, as well as a number of OSGi services, already have number of its own events defined. For uniformity of processing, these have to be mapped into generic event types.

#### 113.1.2 Entities

- *Event* - An Event object has a topic and a Dictionary object that contains the event properties. It is an immutable object.
- *Event Admin* - The service that provides the publish and subscribe model to Event Handlers and Event Publishers.

- *Event Handler* - A service that receives and handles Event objects.
- *Event Publisher* - A bundle that sends event through the Event Admin service.
- *Event Subscriber* - Another name for an Event Handler.
- *Topic* - The name of an Event type.
- *Event Properties* - The set of properties that is associated with an Event.

Figure 113.1

The Event Admin service *org.osgi.service.event* package

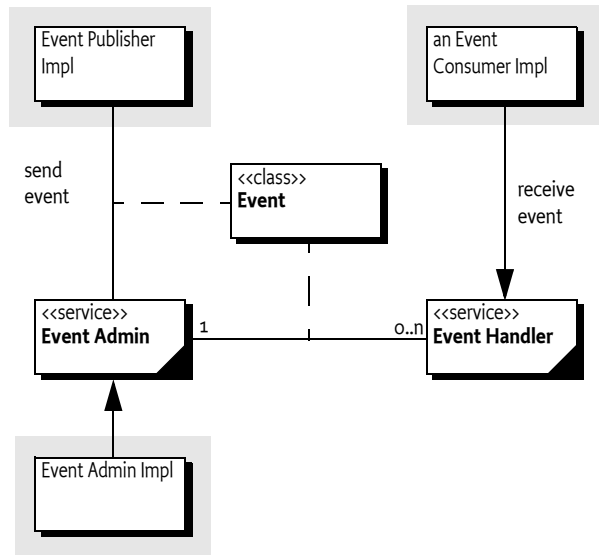

### 113.1.3 Synopsis

The Event Admin service provides a place for bundles to publish events, regardless of their destination. It is also used by Event Handlers to subscribe to specific types of events.

Events are published under a topic, together with a number of event properties. Event Handlers can specify a filter to control the Events they receive on a very fine grained basis.

### 113.1.4 What To Read

- *Architects* - The *Event Admin Architecture* on page 368 provides an overview of the Event Admin service.
- *Event Publishers* - The *Event Publisher* on page 371 provides an introduction of how to write an Event Publisher. The *Event Admin Architecture* on page 368 provides a good overview of the design.
- *Event Subscribers/Handlers* - The *Event Handler* on page 370 provides the rules on how to subscribe and handle events.

## 113.2 Event Admin Architecture

The Event Admin is based on the *Publish-Subscribe* pattern. This pattern decouples sources from their handlers by interposing an *event channel* between them. The publisher posts events to the channel, which identifies which handlers need to be notified and then takes care of the notification process. This model is depicted in Figure 113.2.

Figure 113.2 Channel Pattern

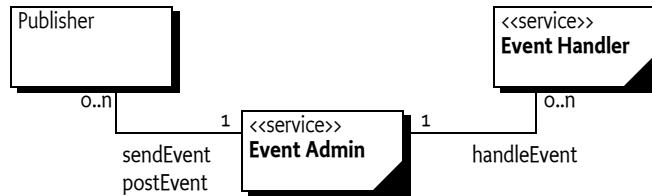

In this model, the event source and event handler are completely decoupled because neither has any direct knowledge of the other. The complicated logic of monitoring changes in the event publishers and event handlers is completely contained within the event channel. This is highly advantageous in an OSGi environment because it simplifies the process of both sending and receiving events.

## 113.3 The Event

Events have the following attributes:

- *Topic* - A topic that defines what happened. For example, when a bundle is started an event is published that has a topic of `org/osgi/framework/BundleEvent/STARTED`.
- *Properties* - Zero or more properties that contain additional information about the event. For example, the previous example event has a property of `bundle.id` which is set to a Long object, among other properties.

### 113.3.1 Topics

The topic of an event defines the *type* of the event. It is fairly granular in order to give handlers the opportunity to register for just the events they are interested in. When a topic is designed, its name should not include any other information, such as the publisher of the event or the data associated with the event, those parts are intended to be stored in the event properties.

The topic is intended to serve as a first-level filter for determining which handlers should receive the event. Event Admin service implementations use the structure of the topic to optimize the dispatching of the events to the handlers.

Topics are arranged in a hierarchical namespace. Each level is defined by a token and levels are separated by solidi (`'/' \u002F`). More precisely, the topic must conform to the following grammar:

```
topic ::= token ( '/' token ) * // See General Syntax Definitions in Core
```

Topics should be designed to become more specific when going from left to right. Handlers can provide a prefix that matches a topic, using the preferred order allows a handler to minimize the number of prefixes it needs to register.

Topics are case-sensitive. As a convention, topics should follow the reverse domain name scheme used by Java packages to guarantee uniqueness. The separator must be a solidus (`'/' \u002F`) instead of the full stop (`'.' \u002E`).

This specification uses the convention `fully/qualified/package/ClassName/ACTION`. If necessary, a pseudo-class-name is used.

### 113.3.2 Properties

Information about the actual event is provided as properties. The property name is a case-sensitive string and the value can be any object. Although any Java object can be used as a property value, only String objects and the eight primitive types (plus their wrappers) should be used. Other types cannot be passed to handlers that reside external from the Java VM.

Another reason that arbitrary classes should not be used is the mutability of objects. If the values are not immutable, then any handler that receives the event could change the value. Any handlers that received the event subsequently would see the altered value and not the value as it was when the event was sent.

The topic of the event is available as a property with the key `EVENT_TOPIC`. This allows filters to include the topic as a condition if necessary.

### 113.3.3 High Performance

An event processing system can become a bottleneck in large systems. One expensive aspect of the Event object is its properties and its immutability. This combination requires the Event object to create a copy of the properties for each object. There are many situations where the same properties are dispatched through Event Admin, the topic is then used to signal the information. Creating the copy of the properties can therefore take unnecessary CPU time and memory. However, the immutability of the Event object requires the properties to be immutable.

For this reason, this specification also provides an immutable Map with the Event Properties class. This class implements an immutable map that is recognized and trusted by the Event object to not mutate. Using an Event Properties object allows a client to create many different Event objects with different topics but sharing the same properties object.

The following example shows how an event poster can limit the copying of the properties.

```
void foo(EventAdmin eventAdmin) {
    Map<String, Object> props = new HashMap<String, Object>();
    props.put("foo", 1);
    EventProperties eventProps = new EventProperties( props);

    for ( int i=0; i<1000; i++)
        eventAdmin.postEvent( new Event( "my/topic/" + i, eventProps));
}
```

## 113.4 Event Handler

Event handlers must be registered as services with the OSGi framework under the object class `org.osgi.service.event.EventHandler`.

Event handlers should be registered with a property (constant from the EventConstants class) `EVENT_TOPIC`. The value being a String, String[] or Collection<String> object that describes which *topics* the handler is interested in. A wildcard asterisk (`'*' \u002A`) may be used as the last token of a topic name, for example `com/action/*`. This matches any topic that shares the same first tokens. For example, `com/action/*` matches `com/action/listen`.

Event Handlers which have not specified the `EVENT_TOPIC` service property must not receive events.

The value of each entry in the `EVENT_TOPIC` service registration property must conform to the following grammar:

```
topic-scope ::= '*' | ( topic '/'*'? )
```

Event handlers can also be registered with a service property named `EVENT_FILTER`. The value of this property must be a string containing a Framework filter specification. Any of the event's properties can be used in the filter expression.

```
event-filter ::= filter // See Filter Syntax in Core
```

Each Event Handler is notified for any event which belongs to the topics the handler has expressed an interest in. If the handler has defined a [EVENT\\_FILTER](#) service property then the event properties must also match the filter expression. If the filter is an error, then the Event Admin service should log a warning and further ignore the Event Handler.

For example, a bundle wants to see all Log Service events with a level of WARNING or ERROR, but it must ignore the INFO and DEBUG events. Additionally, the only events of interest are when the bundle symbolic name starts with com.acme.

```
public AcmeWatchDog implements BundleActivator,
    EventHandler {
    final static String [] topics = new String[] {
        "org.osgi/service/log/LogEntry/LOG_WARNING",
        "org.osgi/service/log/LogEntry/LOG_ERROR" };

    public void start(BundleContext context) {
        Dictionary d = new Hashtable();
        d.put(EventConstants.EVENT_TOPIC, topics );
        d.put(EventConstants.EVENT_FILTER,
            "(bundle.symbolicName=com.acme.*) " );
        context.registerService( EventHandler.class.getName(),
            this, d );
    }
    public void stop( BundleContext context) {}

    public void handleEvent(Event event ) {
        //...
    }
}
```

If there are multiple Event Admin services registered with the Framework then all Event Admin services must send their published events to all registered Event Handlers.

### 113.4.1 Ordering

In the default case, an Event Handler will receive posted (asynchronous) events from a single thread in the same order as they were posted. Maintaining this ordering guarantee requires the Event Admin to serialize the delivery of events instead of, for example, delivering the events on different worker threads. There are many scenarios where this ordering is not really required. For this reason, an Event Handler can signal to the Event Admin that events can be delivered out of order. This is notified with the [EVENT\\_DELIVERY](#) service property. This service property can be used in the following way:

- Not set or set to both - The Event Admin must deliver the events in the proper order.
- [DELIVERY\\_ASYNC\\_ORDERED](#) - Events must be delivered in order.
- [DELIVERY\\_ASYNC\\_UNORDERED](#) - Allow the events to be delivered in any order.

## 113.5 Event Publisher

To fire an event, the event source must retrieve the Event Admin service from the OSGi service registry. Then it creates the event object and calls one of the Event Admin service's methods to fire the event either synchronously or asynchronously.

The following example is a class that publishes a time event every 60 seconds.

```
public class TimerEvent extends Thread
```

```
implements BundleActivator {
    Hashtable    time = new Hashtable();
    ServiceTracker tracker;

    public TimerEvent() { super("TimerEvent"); }

    public void start(BundleContext context ) {
        tracker = new ServiceTracker(context,
            EventAdmin.class.getName(), null );
        tracker.open();
        start();
    }

    public void stop( BundleContext context ) {
        interrupt();
        tracker.close();
    }

    public void run() {
        while ( ! Thread.interrupted() ) try {
            Calendar c = Calendar.getInstance();
            set(c,Calendar.MINUTE,"minutes");
            set(c,Calendar.HOUR,"hours");
            set(c,Calendar.DAY_OF_MONTH,"day");
            set(c,Calendar.MONTH,"month");
            set(c,Calendar.YEAR,"year");

            EventAdmin ea =
                (EventAdmin) tracker.getService();
            if ( ea != null )
                ea.sendEvent(new Event("com/acme/timer",
                    time ));
            Thread.sleep(60000-c.get(Calendar.SECOND)*1000);
        } catch( InterruptedException e ) {
            return;
        }
    }

    void set( Calendar c, int field, String key ) {
        time.put( key, new Integer(c.get(field)) );
    }
}
```



## 113.6 Specific Events

### 113.6.1 General Conventions

Some handlers are more interested in the contents of an event rather than what actually happened. For example, a handler wants to be notified whenever an Exception is thrown anywhere in the system. Both Framework Events and Log Entry events may contain an exception that would be of interest to this hypothetical handler. If both Framework Events and Log Entries use the same property names then the handler can access the Exception in exactly the same way. If some future event type follows the same conventions then the handler can receive and process the new event type even though it had no knowledge of it when it was compiled.

The following properties are suggested as conventions. When new event types are defined they should use these names with the corresponding types and values where appropriate. These values should be set only if they are not null

A list of these property names can be found in the following table.

Table 113.1 *General property names for events*

Name	Type	Notes
<code>BUNDLE_SIGNER</code>	String   Collection <String>	A bundle's signers DN
<code>BUNDLE_VERSION</code>	Version	A bundle's version
<code>BUNDLE_SYMBOLICNAME</code>	String	A bundle's symbolic name
<code>EVENT</code>	Object	The actual event object. Used when rebroadcasting an event that was sent via some other event mechanism
<code>EXCEPTION</code>	Throwable	An exception or error
<code>EXCEPTION_MESSAGE</code>	String	Must be equal to <code>exception.getMessage()</code> .
<code>EXCEPTION_CLASS</code>	String	Must be equal to the name of the Exception class.
<code>MESSAGE</code>	String	A human-readable message that is usually not localized.
<code>SERVICE</code>	Service Reference	A Service Reference
<code>SERVICE_ID</code>	Long	A service's id
<code>SERVICE_OBJECTCLASS</code>	String[]	A service's objectClass
<code>SERVICE_PID</code>	String   Collection <String>	A service's persistent identity. A PID that is specified with a String[] must be coerced into a Collection<String>.
<code>TIMESTAMP</code>	Long	The time when the event occurred, as reported by <code>System.currentTimeMillis()</code>

The topic of an OSGi event is constructed by taking the fully qualified name of the event class, substituting a solidus ('/' \u002F) for every full stop, and appending a solidus followed by the name of the constant that defines the event type. For example, the topic of

```
BundleEvent.STARTED
```

Event becomes

```
org/osgi/framework/BundleEvent/STARTED
```

If a type code for the event is unknown then the event must be ignored.

### 113.6.2 OSGi Events

In order to present a consistent view of all the events occurring in the system, the existing Framework-level events are mapped to the Event Admin's publish-subscribe model. This allows event subscribers to treat framework events exactly the same as other events.

It is the responsibility of the Event Admin service implementation to map these Framework events to its queue.

The properties associated with the event depends on its class as outlined in the following sections.

### 113.6.3 Framework Event

Framework Events must be delivered asynchronously with a topic of:

```
org/osgi/framework/FrameworkEvent/<event type>
```

The following event types are supported:

```
STARTED  
ERROR  
PACKAGES_REFRESHED  
STARTLEVEL_CHANGED  
WARNING  
INFO
```

Other events are ignored, no event will be send by the Event Admin. The following event properties must be set for a Framework Event.

- `event` - (FrameworkEvent) The original event object.

If the FrameworkEvent `getBundle` method returns a non-null value, the following fields must be set:

- `bundle.id` - (Long) The source's bundle id.
- `bundle.symbolicName` - (String) The source bundle's symbolic name. Only set if the bundle's symbolic name is not null.
- `bundle.version` - (Version) The version of the bundle, if set.
- `bundle.signer` - (String|Collection<String>) The DNs of the signers.
- `bundle` - (Bundle) The source bundle.

If the FrameworkEvent `getThrowable` method returns a non-null value:

- `exception.class` - (String) The fully-qualified class name of the attached Exception.
- `exception.message` - (String) The message of the attached exception. Only set if the Exception message is not null.
- `exception` - (Throwable) The Exception returned by the `getThrowable` method.

### 113.6.4 Bundle Event

Framework Events must be delivered asynchronously with a topic of:

```
org/osgi/framework/BundleEvent/<event type>
```

The following event types are supported:

```
INSTALLED  
STARTED  
STOPPED
```

UPDATED  
 UNINSTALLED  
 RESOLVED  
 UNRESOLVED

Unknown events must be ignored.

The following event properties must be set for a Bundle Event. If listeners require synchronous delivery then they should register a Synchronous Bundle Listener with the Framework.

- `event` - (`BundleEvent`) The original event object.
- `bundle.id` - (`Long`) The source's bundle id.
- `bundle.symbolicName` - (`String`) The source bundle's symbolic name. Only set if the bundle's symbolic name is not null.
- `bundle.version` - (`Version`) The version of the bundle, if set.
- `bundle.signer` - (`String|Collection<String>`) The DNs of the signers.
- `bundle` - (`Bundle`) The source bundle.

### 113.6.5 Service Event

Service Events must be delivered asynchronously with the topic:

`org.osgi/framework/ServiceEvent/<event type>`

The following event types are supported:

REGISTERED  
 MODIFIED  
 UNREGISTERING

Unknown events must be ignored.

- `event` - (`ServiceEvent`) The original Service Event object.
- `service` - (`ServiceReference`) The result of the `getServiceReference` method
- `service.id` - (`Long`) The service's ID.
- `service.pid` - (`String` or `Collection<String>`) The service's persistent identity. Only set if not null. If the PID is specified as a `String[]` then it must be coerced into a `Collection<String>`.
- `service.objectClass` - (`String[]`) The service's object class.

### 113.6.6 Other Event Sources

Several OSGi service specifications define their own event model. It is the responsibility of these services to map their events to Event Admin events. Event Admin is seen as a core service that will be present in most devices. However, if there is no Event Admin service present, applications are not mandated to buffer events.

## 113.7 Event Admin Service

The Event Admin service must be registered as a service with the object class `org.osgi.service.event.EventAdmin`. Multiple Event Admin services can be registered. Publishers should publish their event on the Event Admin service with the highest value for the `SERVICE_RANKING` service property. This is the service selected by the `getServiceReference` method.

The Event Admin service is responsible for tracking the registered handlers, handling event notifications and providing at least one thread for asynchronous event delivery.

### 113.7.1 Synchronous Event Delivery

Synchronous event delivery is initiated by the `sendEvent` method. When this method is invoked, the Event Admin service determines which handlers must be notified of the event and then notifies each one in turn. The handlers can be notified in the caller's thread or in an event-delivery thread, depending on the implementation. In either case, all notifications must be completely handled before the `sendEvent` method returns to the caller.

Synchronous event delivery is significantly more expensive than asynchronous delivery. All things considered equal, the asynchronous delivery should be preferred over the synchronous delivery.

Callers of this method will need to be coded defensively and assume that synchronous event notifications could be handled in a separate thread. That entails that they must not be holding any monitors when they invoke the `sendEvent` method. Otherwise they significantly increase the likelihood of deadlocks because Java monitors are not reentrant from another thread by definition. Not holding monitors is good practice even when the event is dispatched in the same thread.

### 113.7.2 Asynchronous Event Delivery

Asynchronous event delivery is initiated by the `postEvent` method. When this method is invoked, the Event Admin service must determine which handlers are interested in the event. By collecting this list of handlers during the method invocation, the Event Admin service ensures that only handlers that were registered at the time the event was posted will receive the event notification. This is the same as described in *Delivering Events of OSGi Core Release 6*.

The Event Admin service can use more than one thread to deliver events. If it does then it must guarantee that each handler receives the events in the same order as the events were posted, unless this handler allows unordered deliver, see *Ordering* on page 371. This ensures that handlers see events in their expected order. For example, for some handlers it would be an error to see a destroyed event before the corresponding created event.

Before notifying each handler, the event delivery thread must ensure that the handler is still registered in the service registry. If it has been unregistered then the handler must not be notified.

### 113.7.3 Order of Event Delivery

Asynchronous events are delivered in the order in which they arrive in the event queue. Thus if two events are posted by the same thread then they will be delivered in the same order (though other events may come between them). However, if two or more events are posted by different threads then the order in which they arrive in the queue (and therefore the order in which they are delivered) will depend very much on subtle timing issues. The event delivery system cannot make any guarantees in this case. An Event Handler can indicate that the ordering is not relevant, allowing the Event Admin to more aggressively parallelize the event deliver, see *Ordering* on page 371.

Synchronous events are delivered as soon as they are sent. If two events are sent by the same thread, one after the other, then they must be guaranteed to be processed serially and in the same order. However, if two events are sent by different threads then no guarantees can be made. The events can be processed in parallel or serially, depending on whether or not the Event Admin service dispatches synchronous events in the caller's thread or in a separate thread.

Note that if the actions of a handler trigger a synchronous event, then the delivery of the first event will be paused and delivery of the second event will begin. Once delivery of the second event has completed, delivery of the first event will resume. Thus some handlers may observe the second event before they observe the first one.

## 113.8 Reliability

### 113.8.1 Exceptions in callbacks

If a handler throws an Exception during delivery of an event, it must be caught by the Event Admin service and handled in some implementation specific way. If a Log Service is available the exception should be logged. Once the exception has been caught and dealt with, the event delivery must continue with the next handlers to be notified, if any.

As the Log Service can also forward events through the Event Admin service there is a potential for a loop when an event is reported to the Log Service.

### 113.8.2 Dealing with Stalled Handlers

Event handlers should not spend too long in the `handleEvent` method. Doing so will prevent other handlers in the system from being notified. If a handler needs to do something that can take a while, it should do it in a different thread.

An event admin implementation can attempt to detect stalled or deadlocked handlers and deal with them appropriately. Exactly how it deals with this situation is left as implementation specific. One allowed implementation is to mark the current event delivery thread as invalid and spawn a new event delivery thread. Event delivery must resume with the next handler to be notified.

Implementations can choose to blacklist any handlers that they determine are misbehaving. Black-listed handlers must not be notified of any events. If a handler is blacklisted, the event admin should log a message that explains the reason for it.

## 113.9 Inter-operability with Native Applications

Implementations of the Event Admin service can support passing events to, and/or receiving events from native applications.

If the implementation supports native inter-operability, it must be able to pass the topic of the event and its properties to/from native code. Implementations must be able to support property values of the following types:

- String objects, including full Unicode support
- Integer, Long, Byte, Short, Float, Double, Boolean, Character objects
- Single-dimension arrays of the above types (including String)
- Single-dimension arrays of Java's eight primitive types (int, long, byte, short, float, double, boolean, char)

Implementations can support additional types. Property values of unsupported types must be silently discarded.

## 113.10 Security

### 113.10.1 Topic Permission

The `TopicPermission` class allows fine-grained control over which bundles may post events to a given topic and which bundles may receive those events.

The target parameter for the permission is the topic name. `TopicPermission` classes uses a wildcard matching algorithm similar to the `BasicPermission` class, except that solidi (`'\u002F'`) are used as

separators instead of full stop characters. For example, a name of `a/b/*` implies `a/b/c` but not `x/y/z` or `a/b`.

There are two available actions: PUBLISH and SUBSCRIBE. These control a bundle's ability to either publish or receive events, respectively. Neither one implies the other.

### 113.10.2 Required Permissions

Bundles that need to register an event handler must be granted `ServicePermission[org.osgi.service.event.EventHandler, REGISTER]`. In addition, handlers require `TopicPermission[ <topic>, SUBSCRIBE ]` for each topic they want to be notified about.

Bundles that need to publish an event must be granted `ServicePermission[ org.osgi.service.event.EventAdmin, GET]` so that they may retrieve the Event Admin service and use it. In addition, event sources require `TopicPermission[ <topic>, PUBLISH]` for each topic they want to send events to.

Bundles that need to iterate the handlers registered with the system must be granted `ServicePermission[org.osgi.service.event.EventHandler, GET]` to retrieve the event handlers from the service registry.

Only a bundle that contains an Event Admin service implementation should be granted `ServicePermission[ org.osgi.service.event.EventAdmin, REGISTER]` to register the event channel admin service.

### 113.10.3 Security Context During Event Callbacks

During an event notification, the Event Admin service's Protection Domain will be on the stack above the handler's Protection Domain. In the case of a synchronous event, the event publisher's protection domain can also be on the stack.

Therefore, if a handler needs to perform a secure operation using its own privileges, it must invoke the `doPrivileged` method to isolate its security context from that of its caller.

The event delivery mechanism must not wrap event notifications in a `doPrivileged` call.

## 113.11 org.osgi.service.event

Event Admin Package Version 1.3.

Bundles wishing to use this package must list the package in the `Import-Package` header of the bundle's manifest. This package has two types of users: the consumers that use the API in this package and the providers that implement the API in this package.

Example import for consumers using the API in this package:

```
Import-Package: org.osgi.service.event; version="[1.3,2.0]"
```

Example import for providers implementing the API in this package:

```
Import-Package: org.osgi.service.event; version="[1.3,1.4]"
```

### 113.11.1 Summary

- `Event` - An event.
- `EventAdmin` - The Event Admin service.
- `EventConstants` - Defines standard names for `EventHandler` properties.
- `EventHandler` - Listener for Events.
- `EventProperties` - The properties for an Event.

- TopicPermission - A bundle's authority to publish or subscribe to event on a topic.

### 113.11.2 public class Event

An event. Event objects are delivered to EventHandler services which subscribe to the topic of the event.

*Concurrency* Immutable

#### 113.11.2.1 public Event(String topic, Map<String, ?> properties)

*topic* The topic of the event.

*properties* The event's properties (may be null). A property whose key is not of type String will be ignored. If the specified properties is an EventProperties object, then it will be directly used. Otherwise, a copy of the specified properties is made.

- Constructs an event.

*Throws* IllegalArgumentException– If topic is not a valid topic name.

*Since* 1.2

#### 113.11.2.2 public Event(String topic, Dictionary<String, ?> properties)

*topic* The topic of the event.

*properties* The event's properties (may be null). A property whose key is not of type String will be ignored. A copy of the specified properties is made.

- Constructs an event.

*Throws* IllegalArgumentException– If topic is not a valid topic name.

#### 113.11.2.3 public final boolean containsProperty(String name)

*name* The name of the property.

- Indicate the presence of an event property. The event topic is present using the property name "event.topics".

*Returns* true if a property with the specified name is in the event. This property may have a null value. false otherwise.

*Since* 1.3

#### 113.11.2.4 public boolean equals(Object object)

*object* The Event object to be compared.

- Compares this Event object to another object.

An event is considered to be **equal to** another event if the topic is equal and the properties are equal. The properties are compared using the java.util.Map.equals() rules which includes identity comparison for array values.

*Returns* true if object is a Event and is equal to this object; false otherwise.

#### 113.11.2.5 public final Object getProperty(String name)

*name* The name of the property to retrieve.

- Retrieve the value of an event property. The event topic may be retrieved with the property name "event.topics".

*Returns* The value of the property, or null if not found.

**113.11.2.6 public final String[] getPropertyNames()**

- Returns a list of this event's property names. The list will include the event topic property name "event.topics".

*Returns* A non-empty array with one element per property.

**113.11.2.7 public final String getTopic()**

- Returns the topic of this event.

*Returns* The topic of this event.

**113.11.2.8 public int hashCode()**

- Returns a hash code value for this object.

*Returns* An integer which is a hash code value for this object.

**113.11.2.9 public final boolean matches(Filter filter)**

*filter* The filter to test.

- Tests this event's properties against the given filter using a case sensitive match.

*Returns* true If this event's properties match the filter, false otherwise.

**113.11.2.10 public String toString()**

- Returns the string representation of this event.

*Returns* The string representation of this event.

**113.11.3 public interface EventAdmin**

The Event Admin service. Bundles wishing to publish events must obtain the Event Admin service and call one of the event delivery methods.

*Concurrency* Thread-safe

*Provider Type* Consumers of this API must not implement this type

**113.11.3.1 public void postEvent(Event event)**

*event* The event to send to all listeners which subscribe to the topic of the event.

- Initiate asynchronous, ordered delivery of an event. This method returns to the caller before delivery of the event is completed. Events are delivered in the order that they are received by this method.

*Throws* SecurityException– If the caller does not have TopicPermission[topic,PUBLISH] for the topic specified in the event.

**113.11.3.2 public void sendEvent(Event event)**

*event* The event to send to all listeners which subscribe to the topic of the event.

- Initiate synchronous delivery of an event. This method does not return to the caller until delivery of the event is completed.

*Throws* SecurityException– If the caller does not have TopicPermission[topic,PUBLISH] for the topic specified in the event.

**113.11.4 public interface EventConstants**

Defines standard names for EventHandler properties.



*Provider Type* Consumers of this API must not implement this type

**113.11.4.1**      **public static final String BUNDLE = "bundle"**

The Bundle object of the bundle relevant to the event. The type of the value for this event property is Bundle.

*Since* 1.1

**113.11.4.2**      **public static final String BUNDLE\_ID = "bundle.id"**

The Bundle id of the bundle relevant to the event. The type of the value for this event property is Long.

*Since* 1.1

**113.11.4.3**      **public static final String BUNDLE\_SIGNER = "bundle.signer"**

The Distinguished Names of the signers of the bundle relevant to the event. The type of the value for this event property is String or Collection of String.

**113.11.4.4**      **public static final String BUNDLE\_SYMBOLICNAME = "bundle.symbolicName"**

The Bundle Symbolic Name of the bundle relevant to the event. The type of the value for this event property is String.

**113.11.4.5**      **public static final String BUNDLE\_VERSION = "bundle.version"**

The version of the bundle relevant to the event. The type of the value for this event property is Version.

*Since* 1.2

**113.11.4.6**      **public static final String DELIVERY\_ASYNC\_ORDERED = "async.ordered"**

Event Handler delivery quality value specifying the Event Handler requires asynchronously delivered events be delivered in order. Ordered delivery is the default for asynchronously delivered events.

This delivery quality value is mutually exclusive with DELIVERY\_ASYNC\_UNORDERED. However, if both this value and DELIVERY\_ASYNC\_UNORDERED are specified for an event handler, this value takes precedence.

*See Also* EVENT\_DELIVERY

*Since* 1.3

**113.11.4.7**      **public static final String DELIVERY\_ASYNC\_UNORDERED = "async.unordered"**

Event Handler delivery quality value specifying the Event Handler does not require asynchronously delivered events be delivered in order. This may allow an Event Admin implementation to optimize asynchronous event delivery by relaxing ordering requirements.

This delivery quality value is mutually exclusive with DELIVERY\_ASYNC\_ORDERED. However, if both this value and DELIVERY\_ASYNC\_ORDERED are specified for an event handler, DELIVERY\_ASYNC\_ORDERED takes precedence.

*See Also* EVENT\_DELIVERY

*Since* 1.3

**113.11.4.8**      **public static final String EVENT = "event"**

The forwarded event object. Used when rebroadcasting an event that was sent via some other event mechanism. The type of the value for this event property is Object.

- 113.11.4.9**      **public static final String EVENT\_DELIVERY = "event.delivery"**
- Service Registration property specifying the delivery qualities requested by an Event Handler service.
- Event handlers MAY be registered with this property. Each value of this property is a string specifying a delivery quality for the Event handler.
- The value of this property must be of type String, String[], or Collection<String>.
- See Also* DELIVERY\_ASYNC\_ORDERED, DELIVERY\_ASYNC\_UNORDERED
- Since* 1.3
- 113.11.4.10**      **public static final String EVENT\_FILTER = "event.filter"**
- Service Registration property specifying a filter to further select Events of interest to an Event Handler service.
- Event handlers MAY be registered with this property. The value of this property is a string containing an LDAP-style filter specification. Any of the event's properties may be used in the filter expression. Each event handler is notified for any event which belongs to the topics in which the handler has expressed an interest. If the event handler is also registered with this service property, then the properties of the event must also match the filter for the event to be delivered to the event handler.
- If the filter syntax is invalid, then the Event Handler must be ignored and a warning should be logged.
- The value of this property must be of type String.
- See Also* Event, Filter
- 113.11.4.11**      **public static final String EVENT\_TOPIC = "event.topics"**
- Service registration property specifying the Event topics of interest to an Event Handler service.
- Event handlers SHOULD be registered with this property. Each value of this property is a string that describe the topics in which the handler is interested. An asterisk (\*) may be used as a trailing wildcard. Event Handlers which do not have a value for this property must not receive events. More precisely, the value of each string must conform to the following grammar:
- ```
topic-description := '*' | topic ( '/'* )?
topic := token ( '/' token )*
```
- The value of this property must be of type String, String[], or Collection<String>.
- See Also* Event
- 113.11.4.12**      **public static final String EXCEPTION = "exception"**
- An exception or error. The type of the value for this event property is Throwable.
- 113.11.4.13**      **public static final String EXCEPTION\_CLASS = "exception.class"**
- The name of the exception type. Must be equal to the name of the class of the exception in the event property EXCEPTION. The type of the value for this event property is String.
- Since* 1.1
- 113.11.4.14**      **public static final String EXCEPTION\_MESSAGE = "exception.message"**
- The exception message. Must be equal to the result of calling getMessage() on the exception in the event property EXCEPTION. The type of the value for this event property is String.

**113.11.4.15**      **public static final String EXCEPTION\_CLASS = "exception.class"**

This constant was released with an incorrectly spelled name. It has been replaced by EXCEPTION\_CLASS

*Deprecated* As of 1.1, replaced by EXCEPTION\_CLASS

**113.11.4.16**      **public static final String MESSAGE = "message"**

A human-readable message that is usually not localized. The type of the value for this event property is String.

**113.11.4.17**      **public static final String SERVICE = "service"**

A service reference. The type of the value for this event property is ServiceReference.

**113.11.4.18**      **public static final String SERVICE\_ID = "service.id"**

A service's id. The type of the value for this event property is Long.

**113.11.4.19**      **public static final String SERVICE\_OBJECTCLASS = "service.objectClass"**

A service's objectClass. The type of the value for this event property is String[].

**113.11.4.20**      **public static final String SERVICE\_PID = "service.pid"**

A service's persistent identity. The type of the value for this event property is String or Collection of String.

**113.11.4.21**      **public static final String TIMESTAMP = "timestamp"**

The time when the event occurred, as reported by System.currentTimeMillis(). The type of the value for this event property is Long.

**113.11.5**      **public interface EventHandler**

Listener for Events.

EventHandler objects are registered with the Framework service registry and are notified with an Event object when an event is sent or posted.

EventHandler objects can inspect the received Event object to determine its topic and properties.

EventHandler objects must be registered with a service property EventConstants.EVENT\_TOPIC whose value is the list of topics in which the event handler is interested.

For example:

```
String[] topics = new String[] {"com/isv/*"};
Hashtable ht = new Hashtable();
ht.put(EventConstants.EVENT_TOPIC, topics);
context.registerService(EventHandler.class.getName(), this, ht);
```

Event Handler services can also be registered with an EventConstants.EVENT\_FILTER service property to further filter the events. If the syntax of this filter is invalid, then the Event Handler must be ignored by the Event Admin service. The Event Admin service should log a warning.

Security Considerations. Bundles wishing to monitor Event objects will require ServicePermission[EventHandler,REGISTER] to register an EventHandler service. The bundle must also have TopicPermission[topic,SUBSCRIBE] for the topic specified in the event in order to receive the event.

*See Also* Event

*Concurrency* Thread-safe

**113.11.5.1 public void handleEvent(Event event)**

*event* The event that occurred.

- Called by the EventAdmin service to notify the listener of an event.

**113.11.6 public class EventProperties implements Map<String, Object>**

The properties for an Event. An event source can create an EventProperties object if it needs to reuse the same event properties for multiple events.

The keys are all of type String. The values are of type Object. The key "event.topics" is ignored as event topics can only be set when an Event is constructed.

Once constructed, an EventProperties object is unmodifiable. However, the values of the map used to construct an EventProperties object are still subject to modification as they are not deeply copied.

*Since* 1.3

*Concurrency* Immutable

**113.11.6.1 public EventProperties(Map<String, ?> properties)**

*properties* The properties to use for this EventProperties object (may be null).

- Create an EventProperties from the specified properties.

The specified properties will be copied into this EventProperties. Properties whose key is not of type String will be ignored. A property with the key "event.topics" will be ignored.

**113.11.6.2 public void clear()**

- This method throws UnsupportedOperationException.

*Throws* UnsupportedOperationException– if called.

**113.11.6.3 public boolean containsKey(Object name)**

*name* The property name.

- Indicates if the specified property is present.

*Returns* true If the property is present, false otherwise.

**113.11.6.4 public boolean containsValue(Object value)**

*value* The property value.

- Indicates if the specified value is present.

*Returns* true If the value is present, false otherwise.

**113.11.6.5 public Set<Map.Entry<String, Object>> entrySet()**

- Return the property entries.

*Returns* A set containing the property name/value pairs.

**113.11.6.6 public boolean equals(Object object)**

*object* The EventProperties object to be compared.

- Compares this EventProperties object to another object.

The properties are compared using the java.util.Map.equals() rules which includes identity comparison for array values.

*Returns* true if object is a EventProperties and is equal to this object; false otherwise.



A topic is a slash-separated string that defines a topic.

For example:

```
org/osgi/service/foo/FooEvent/ACTION
```

TopicPermission has two actions: publish and subscribe.

*Concurrency* Thread-safe

**113.11.7.1**      **public static final String PUBLISH = "publish"**

The action string publish.

**113.11.7.2**      **public static final String SUBSCRIBE = "subscribe"**

The action string subscribe.

**113.11.7.3**      **public TopicPermission(String name,String actions)**

*name* Topic name.

*actions* publish,subscribe (canonical order).

- Defines the authority to publish and/or subscribe to a topic within the EventAdmin service.

The name is specified as a slash-separated string. Wildcards may be used. For example:

```
org/osgi/service/fooFooEvent/ACTION
com/isv/*
*
```

A bundle that needs to publish events on a topic must have the appropriate TopicPermission for that topic; similarly, a bundle that needs to subscribe to events on a topic must have the appropriate TopicPermission for that topic.

**113.11.7.4**      **public boolean equals(Object obj)**

*obj* The object to test for equality with this TopicPermission object.

- Determines the equality of two TopicPermission objects. This method checks that specified TopicPermission has the same topic name and actions as this TopicPermission object.

*Returns* true if obj is a TopicPermission, and has the same topic name and actions as this TopicPermission object; false otherwise.

**113.11.7.5**      **public String getActions()**

- Returns the canonical string representation of the TopicPermission actions.

Always returns present TopicPermission actions in the following order: publish,subscribe.

*Returns* Canonical string representation of the TopicPermission actions.

**113.11.7.6**      **public int hashCode()**

- Returns the hash code value for this object.

*Returns* A hash code value for this object.

**113.11.7.7**      **public boolean implies(Permission p)**

*p* The target permission to interrogate.

- Determines if the specified permission is implied by this object.

This method checks that the topic name of the target is implied by the topic name of this object. The list of TopicPermission actions must either match or allow for the list of the target object to imply the target TopicPermission action.

```
x/y/*, "publish" -> x/y/z, "publish" is true
*, "subscribe" -> x/y, "subscribe" is true
*, "publish" -> x/y, "subscribe" is false
x/y, "publish" -> x/y/z, "publish" is false
```

*Returns* true if the specified TopicPermission action is implied by this object; false otherwise.

#### **113.11.7.8 public PermissionCollection newPermissionCollection()**

- Returns a new PermissionCollection object suitable for storing TopicPermission objects.

*Returns* A new PermissionCollection object.





# 114 Deployment Admin Specification

## Version 1.1

### 114.1 Introduction

The ability to install new software components after the time of manufacture is of increasing interest to manufacturers, operators, and end users. End users already are, or soon will be, accustomed to installing applications or services on their devices from remote servers.

The OSGi Framework provides mechanisms to manage the lifecycle of bundles, configuration objects, and permission objects, but the overall consistency of the runtime configuration is the responsibility of the *management agent*. In other words, the management agent decides to install, update, or uninstall bundles, create or delete configuration or permission objects, and manage other resource types.

The task of the management agent is extensive because it must track the sometimes fine-grained dependencies and constraints between the different resource types. This model, though extremely flexible, leaves many details up to the implementation significantly hindering the inter-operability of devices because it does not unify the management aspects from the management systems point of view. This specification, therefore, introduces the *Deployment Admin service* that standardizes the access to some of the responsibilities of the management agent: that is, the life-cycle management of interlinked resources on an OSGi Framework. The role of the Deployment Admin service is depicted in Figure 114.1.

Figure 114.1

*Deployment Admin role*

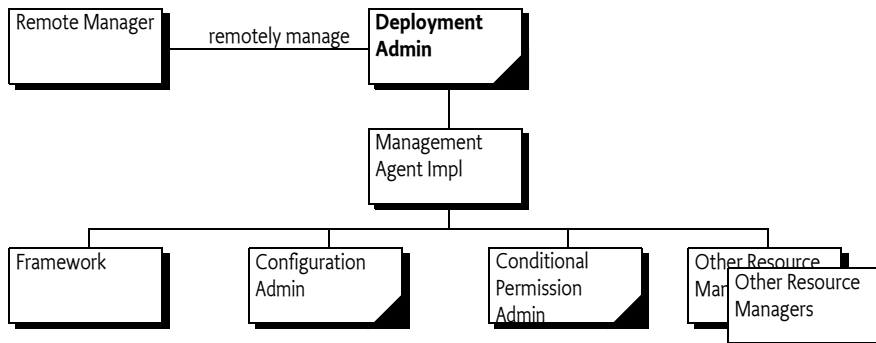

#### 114.1.1

### Essentials

- *Installing/Uninstalling* - Provide a Deployment Package concept to install and uninstall bundles and related resources on an OSGi Framework as an atomic unit.
- *Tamper Detection* - Provide detection of changes to a Deployment Package.
- *Securing* - Provide a security model that allows Operators to control the Deployment Packages that are installed on an OSGi Framework.
- *Media Independence* - Deployment Packages must have the capacity to load from different media such as CD-ROM, over the air, wireless, etc.
- *Management* - Management of a repository of Deployment Packages must be possible locally on the device as well as remotely.

- *Customizing* - The author of a Deployment Package must be permitted to customize the environment during the installation and uninstallation operations.
- *Extending* - The resource types that are used in a Deployment Package must be easy to extend.

### 114.1.2 Entities

- *Resource* - A file in a Deployment Package that is processed to create artifacts in the Framework. For example, bundles, configurations, and permissions are different resources.
- *Deployment Admin Service* - The service that is used to install and uninstall Deployment Packages, as well as to provide information about the repository of Deployment Packages.
- *Resource Processor* - A service that can handle the lifecycle of a specific resource type. It processes a resource to create a number of artifacts that are removed when the resource is dropped.
- *Deployment Package* - A group of resources that must be treated as a unit. Unbreakable dependencies exist among these resources.
- *Artifact* - A construct that is created from a Resource in a Deployment Package. A resource can have zero or more artifacts related to it. Artifacts do not have a common interface because their nature differs and their existence is abstracted by the Resource Processor services. Artifacts must be removed when their related resources are dropped. An example of an artifact is a Configuration object that is created from an configuration file in a Deployment Package.
- *Customizer* - A bundle carried in a Deployment Package that can perform initialization during an install operation and cleanup during an uninstall operation.
- *Fix Package* - A Deployment Package that is an update to an resident Deployment Package, which does not carry some resources because they are unchanged.

Figure 114.2 Deployment Admin Service, `org.osgi.service.deploymentadmin` package

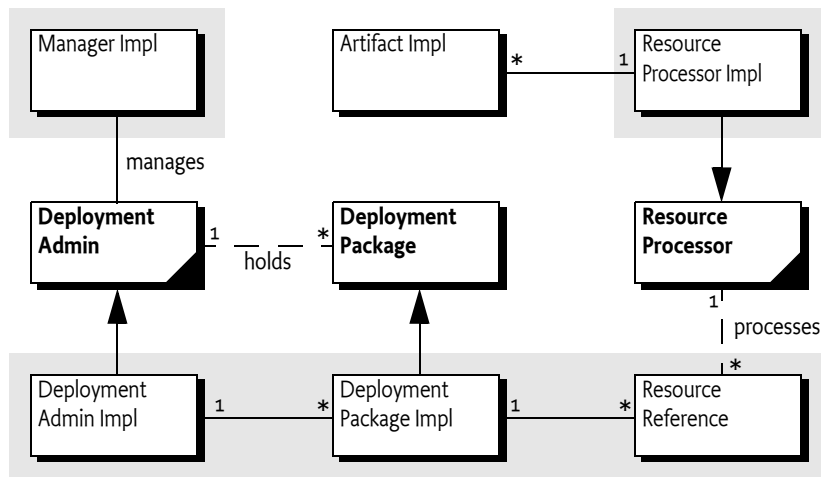

### 114.1.3 Synopsis

A developer can package a number of resources in a Deployment Package. A Deployment Package is stored in a JAR file, with a format that is similar to bundles. A Deployment Package JAR can be installed via the Deployment Admin service via an input stream. The Deployment Admin service manages the bundle resources itself, but processes every other resource in the Deployment Package by handing them off to a Resource Processor service that is designated for that resource. The Resource Processor service will then process the resource to create a number of artifacts.

The uninstallation and update of a Deployment Package works in a similar manner. All Resource Processor services are notified about any resources that are dropped or changed.

If all resources have been processed, the changes are committed. If an operation on the Deployment Admin service fails, all changes are rolled back. The Deployment Admin service is not, however, guaranteed to support all features of transactions.

## 114.2 Deployment Package

A Deployment Package is a set of related *resources* that need to be managed as a *unit* rather than individual pieces. For example, a Deployment Package can contain both a bundle and its configuration data. The resources of a Deployment Package are tightly coupled to the Deployment Package and cannot be shared with other Deployment Packages.

A Deployment Package is not a script that brings the system from one consistent state to another; several deployment packages may be needed to achieve a new consistent state. Like a bundle, a Deployment Package does not have to be self-contained. Its bundle resources can have dependencies on Java packages and services provided by other Deployment Packages.

For example, a suite of games shares some parts that are common to both games. The suite contains two games: Chess (`com.acme.chess`) and Backgammon (`com.acme.backg`). Both share a top-score database as well as a 3D graphic library.

- `com.third.3d` - The 3D graphic library comes from a third-party provider. It is a Deployment Package of its own, composed of several bundles and possible configuration objects.
- `com.acme.score` - The top-score database would also be its own Deployment Package, and would in fact be optional. It offers a service for storing top scores, but games can function without this service.

Each game is a Deployment Package, allowing them to be installed independently. Alternatively, the two games can be packaged into the same Deployment Package, but in this case they must be installed and removed together and can no longer be deployed independently.

These two different packaging strategies cannot be used simultaneously. Once the games are deployed separately, they can no longer be grouped later in an update, because that action would move ownership of the bundle resource to another Deployment Package which is specifically not allowed. A bundle resource can belong to only one Deployment Package.

These two packaging scenarios are depicted in Figure 114.3.

Figure 114.3

Packaged game

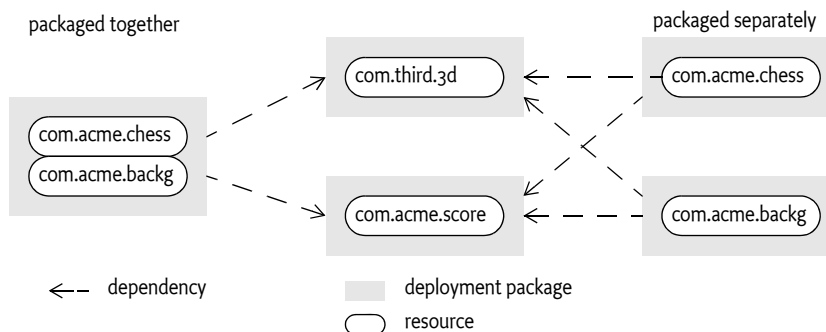

Deployment Packages are managed as *first-class citizens* during runtime, similar to bundles. The `DeploymentPackage` object represents this concept in runtime.

### 114.2.1

#### Resources

A Deployment Package consists of installable *resources*. Resources are described in the *Name sections* of the Manifest. They are stored in the JAR file under a path. This path is called the *resource id*.

Subsets of these resources are the bundles. Bundles are treated differently from the other resources by the Deployment Admin service. Non-bundle resources are called *processed resources*.

Bundles are managed by the Deployment Admin service directly. When installing a new bundle, the Deployment Admin service must set the bundle location to the following URL:

```
location ::= 'osgi-dp:' bsn
bsn      ::= unique-name    // See General Syntax Definitions in Core
```

The *bsn* stands for the bundle's Bundle Symbolic Name, without any parameters, which implies that only a single version of a bundle can be installed at any moment in time. The *osgi-dp:* scheme is not required to have a valid URL handler.

Processed resources are not managed directly by the Deployment Admin service; their management must be handed off to a Resource Processor service that is selected in the Name section. The logical structure and processing of resources is depicted in Figure 114.4.

Figure 114.4 Structure of a Deployment Package

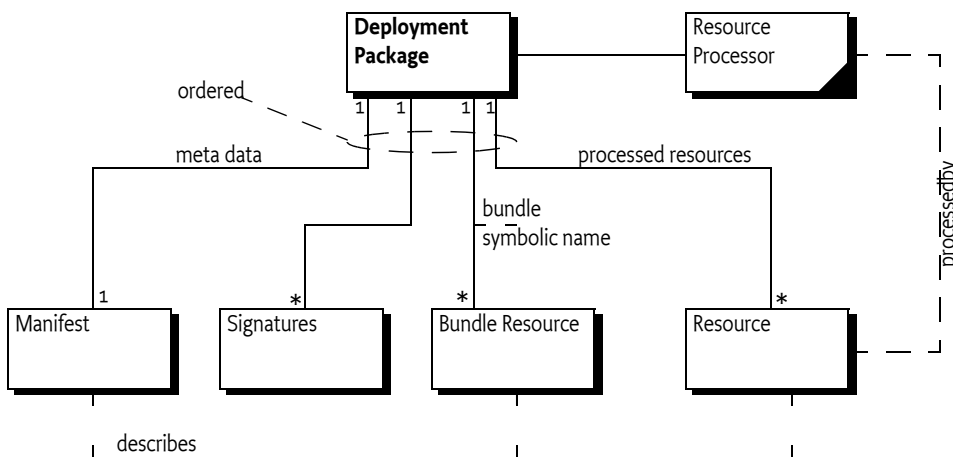

## 114.2.2 Atomicity and Sharing

A Deployment Package is a reified concept, like a bundle, in an OSGi Framework. It is created and managed by the Deployment Admin service. As a unit, a Deployment Package should be installed or uninstalled atomically.

Deployment packages provide an ownership model for resources installed in an OSGi Framework. A Deployment Package contains resources, which once processed, will result in the creation of a number of artifacts in the OSGi Platform such as:

- Installed bundles
- Configuration objects
- System properties
- Certificates
- Wiring schemes

A Deployment Package will *own* its resources. If a Deployment Package is uninstalled, all its resources, and thus its artifacts, must be removed as well. The ownership model follows a *no-sharing* principle: equal resources are not shared between deployment packages.

The meaning of "equal" is dependent on the resource type. For example, two bundles are considered equal if their bundle symbolic name is equal, regardless of the version.

A sharing violation must be considered an error. The install or update of the offending Deployment Package must fail if a resource would be affected by another Deployment Package. The verification of this rule is delegated to the Resource Processor services, or the Deployment Admin service in case of bundles.

For example, a Deployment Package could be used to install bundles and configuration objects for Managed Services (singleton configurations). Because of the no-sharing principle, an installed bundle must belong to one, and only one, Deployment Package (as defined by its Bundle Symbolic Name). A singleton configuration can be set only when the associated bundle is in the same Deployment Package. Trying to install a Deployment Package when one of the bundles or one of the configuration objects is already present and associated with another Deployment Package is an error, and the install must fail in such a case.

This strong no-sharing rule ensures a clean and robust lifecycle. It allows the simple cleanup rule: the Deployment Package that installs a resource is the one that must uninstall it.

### 114.2.3 Naming

Every Deployment Package must have a name and a version. Package authors should use unique reverse domain naming, like the naming used for Java packages. The version syntax must follow the rules defined in *Version* in [2]; the version must be specified.

The name is set with a Manifest header. This name is used to detect whether an install is an update (an Deployment Package has the given name) or an install (no such Deployment Package exists). The name must be compared in a case-sensitive manner.

Together, the name and version specify a unique Deployment Package; a device will consider any Deployment Package with the same name and version pairs to be identical. Installing a Deployment Package with a name version identical to the existing Deployment Package must not result in any actions.

Deployment packages with the same name but different versions are considered to be *versions* of the *same* deployment package. The Deployment Admin service maintains a repository of installed Deployment Packages. This set must not contain multiple versions of the same Deployment Package. Installing a deployment package when a prior or later version was already present must cause replacement of the existing deployment package. In terms of version, this action can be either an upgrade or downgrade.

## 114.3 File Format

A Deployment Package is a standard JAR file as specified in [1] *JAR File Specification*. The extension of a Deployment Package JAR file name should be `.dp`. The MIME type of a Deployment Package JAR should be:

```
application/vnd.osgi.dp
```

For example, valid Deployment Package JAR names are:

```
com.acme.chess.dp  
chess.dp
```

A Deployment Package must be formed in such a way that it can be read with a `JarInputStream` object. Therefore, the order of the files in the JAR file is important. The order must be:

1. META-INF/MANIFEST.MF - A Deployment Package must begin with a standard Java Manifest file. This rule is not explicitly defined in the Java JAR file specification; it is implied, however, by the known `JarInputStream` class implementations.

2. META-INF/\*.SF, META-INF/\*.DSA, META-INF/\*.RS - If the Deployment Package is signed, subsequent files in the JAR must be the signature files as defined in the manifest specification. The signature files are not considered resources. Signing is discussed in *Signing* on page 394.
3. *Localization files* - Any manifest localization files are normally stored in the OSGI-INF directory. Localization files must precede the other files because the resource processors can require localized information.
4. *Bundles* must come before any other resource types so that they can be installed before any processed resources.
5. *Resources* - Any processed resources needed for this package. Resources are processed in the order in which they appear in the JAR file, and dropped in reverse order.

The order of all the resources in the JAR file is significant, and is called the *resource order*. The purpose of the resource order is to allow the JAR to be processed as a stream. It is not necessary to buffer the input stream in memory or to hard disk, or to allow random access to its contents. The specification allows access to the stream sequentially. To increase the determinism, the resource order must also determine the processing order of the bundles and the resources.

The format is shown graphically in Figure 114.5.

Figure 114.5 *Deployment Package JAR format*

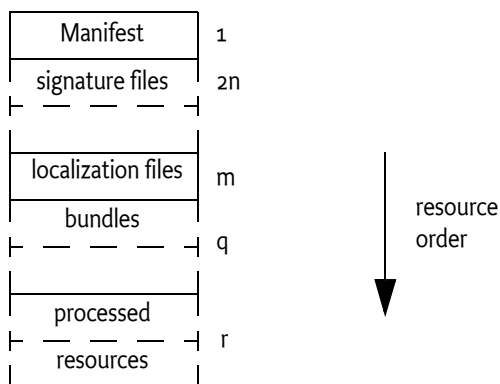

### 114.3.1 Signing

Deployment packages are optionally signed by JAR signing, compatible with the operation of the standard `java.util.jar.JarInputStream` class, i.e. as defined in *JAR Structure and Manifest* of [2]. This compatibility requires that the manifest must be the first file in the input stream, and the signature files must follow directly thereafter.

A Deployment Package must follow the same rules for signing as bundles, described in the Framework specification, *Digitally Signed JAR Files* in [2].

The Deployment Admin service must reject a Deployment Package that has an invalid signature.

### 114.3.2 Path Names

Path names must be limited to remove some of the unnecessary complexities that are caused by path names that can contain any Unicode character. Therefore, a path name must not contain any character except:

[A-Za-z0-9\_.-]

Directories are separated by a solidus character ('/' \u002F).

### 114.3.3 Deployment Package Manifest

The Manifest of a Deployment Package consists of a *global section* and separate sections for each resource contained within it, called the *Name sections*. The global section of a Deployment Package Manifest can contain the following headers that have a defined meaning in this specification:

- `DeploymentPackage-SymbolicName` - The name of the deployment package as a reverse domain name. For example, `com.acme.chess`. See further *DeploymentPackage-SymbolicName* on page 396.
- `DeploymentPackage-Version` - The version of the deployment package as defined in [2]. See further *DeploymentPackage-Version* on page 397.
- `DeploymentPackage-FixPack` - Marks this deployment package as a partial update to a resident deployment package. See *Fix Package* on page 400.

The following headers provide information about the Deployment Package, but are not interpreted by the Deployment Admin service.

- `DeploymentPackage-Name` - A human readable of this deployment package. This name can be localized.
- `DeploymentPackage-Copyright` - Specifies the copyright statement for this Deployment Package.
- `DeploymentPackage-ContactAddress` - How to contact the vendor/developer of this Deployment Package.
- `DeploymentPackage-Description` - A short description of this Deployment Package.
- `DeploymentPackage-DocURL` - A URL to any documentation that is available for this Deployment Package. The URL can be relative to the JAR file.
- `DeploymentPackage-Icon` - A URL to an image file that is an icon for this deployment package. The URL can be relative to the JAR file.
- `DeploymentPackage-Vendor` - The vendor of the Deployment Package.
- `DeploymentPackage-License` - A URL to a license file. The URL can be relative to the Deployment Package JAR file.
- `DeploymentPackage-RequiredStorage` - The minimum amount of persistent storage required by the deployment package after successful install or update.

As with any JAR file Manifest, additional headers can be added and must be ignored by the Deployment Admin service. If any fields have human readable content, localization can be provided through property files as described in *Localization* in [2]. The Deployment Admin service must always use the raw, untranslated version of the header values.

For example, the global section of a Deployment Package Manifest could look like:

```
Manifest-Version: 1.0
DeploymentPackage-SymbolicName: com.third._3d
DeploymentPacakge-Version: 1.2.3.build22032005
DeploymentPackage-Copyright: ACME Inc. (c) 2003
↵
```

Additionally, the Deployment Package Manifest must carry a *Name section* for each resource in the JAR file (except the resources in the META-INF directory). Each name section must start with an empty line (carriage return and line feed, shown as ↵ when its usage could be ambiguous).

The Name section must start with a Name header that contains the path name of the resource. This path name is also used as resource id. The path name must be constructed with the characters as defined in *Path Names* on page 394. For example:

```
Name: bundles/3dlib.jar
```

The name section can include any additional relevant meta data for the named resource. For bundles, only the specification of the `Bundle-SymbolicName` and `Bundle-Version` headers are required, but other headers can be added. Unrecognized headers are allowed and must be ignored by the Deployment Admin service. The Name section is also used by the JAR signing to include digests of the actual resources.

The following headers are architected for the Name section in the manifest of a deployment package:

- *Bundle-SymbolicName* - Only for bundle resources. This header must be identical to the Bundle Symbolic Name of the named bundle. If there is a discrepancy, the install of the Deployment Package must fail. If the bundle resource has no `Bundle-SymbolicName` in its manifest, however, the Deployment Admin must use the given symbolic name for the calculation of the location of this bundle.
- *Bundle-Version* - Only for bundle resources. This header must be identical to the bundle version of the named bundle. Its syntax must follow the version syntax as defined in the Framework specification. The installation must fail if incorrect.
- *DeploymentPackage-Missing* - (true|false) Indicates that the resource is logically part of the Deployment Package but that a previous version of the Deployment Package already contained this resource there is no data for this resource. See *Fix Package* on page 400 for a further explanation.
- *Resource-Processor* - The PID of the Resource Processor service that must install the given resource.
- *DeploymentPackage-Customizer* - (true|false) Indicates whether this bundle is a customizer bundle by listing a PID for the customizer service. See a further discussion in *Customizer* on page 401.

An example Manifest of a Deployment Package that deploys the 3D package, consisting of two bundles and no resources, could look like:

```
Manifest-Version: 1.0
DeploymentPackage-Icon: %icon
DeploymentPackage-SymbolicName: com.third._3d
DeploymentPacakge-Version: 1.2.3.build22032005
↵
Name: bundles/3dlib.jar
SHA-1-Digest: M0ez1l4gXHBo8ycYdAxstK3UvEg=
Bundle-SymbolicName: com.third._3d
Bundle-Version: 2.3.1
↵
Name: bundles/3dnative.jar
SHA-1-Digest: N8Ow2UY4yjnHZv5zeq2I1Uv/+uE=
Bundle-SymbolicName: com.third._3d.native
Bundle-Version: 1.5.3
↵
Name: OSGI-INF/autoconf.xml
SHA-1-Digest: M78w24912HgiZv5zeq2X1Uv-+uF=
Resource-Processor: org.osgi.deployment.rp.autoconf
↵
```

## 114.3.4 Deployment Package Headers

This section contains a detailed description of the different headers for a Deployment Package with their value syntax.

### 114.3.4.1 DeploymentPackage-SymbolicName

The name of the deployment package. A name must follow the same rules as Java packages. The grammar is as follows:



```
DeploymentPackage-SymbolicName ::= unique-name
                               // See General Syntax Definitions in Core
```

This header is mandatory and must not be localized.

An example is:

```
DeploymentPackage-SymbolicName: com.acme.chess
```

#### 114.3.4.2 **DeploymentPackage-Version**

This header defines the version of the deployment package. The syntax follows the standard OSGi Framework rules for versions.

```
DeploymentPackage-Version ::= version // See Version in Core
```

This header is mandatory and must follow the syntax of the version. It must not be localized.

An example:

```
DeploymentPackage-Version: 1.2.3.build200501041230
```

#### 114.3.4.3 **DeploymentPackage-FixPack**

A fix package can be distinguished from the full format Deployment Package through the presence of the DeploymentPackage-FixPack header, contained within the global section of the Manifest. The format of this header is:

```
DeploymentPackage-FixPack ::= version-range
                             // See Version Range in Core
```

The version range syntax is identical to the Framework module's layer version range as defined in [2]. For example, a Manifest header that denotes a fix package which is only applicable to versions 1.3 through 3.4 of a given deployment package looks like:

```
DeploymentPackage-FixPack: [1.3, 3.4]
```

See *Fix Package* on page 400 for more information about Fix Packages.

#### 114.3.4.4 **DeploymentPackage-Icon**

This header contains a URL (absolute or relative to the JAR file) to an image resource that represents this deployment package. Implementations should support at least the HTTP protocol as well as the PNG image file. This URL can be localized. The Deployment Admin service must maintain a local copy of the image resource. A URL to this local resource can be obtained with the [getIcon\(\)](#) method.

```
DeploymentPackage-Icon ::= url
url ::= <absolute or relative URL or localization name>
```

For example:

```
DeploymentPackage-Icon: %iicon
```

#### 114.3.4.5 **DeploymentPackage-Name**

This header is available as the DeploymentPackage [getDisplayname](#) method. It provides a human readable name that can be localized. It is available through the [getDisplayname\(\)](#) method. This name can be localized.

```
DeploymentPackage ::= name
```

name ::= <any value or a localization name>

Example:

DeploymentPackage: 3D-Library

#### 114.3.4.6 **DeploymentPackage-RequiredStorage**

This header specifies the minimum amount of persistent storage required by the deployment package after successful install or update. The value is an integer that represent kilo-bytes. The value includes the size of the bundles and any persistent storage needs and storage needed to run the resource processors and customizers. An installation agent can verify the availability of sufficient memory before installing the package. A fix-pack must specify the minimum memory requirements of the complete deployment package after the it is applied.

DeploymentPackage-RequiredStorage ::= number

Example

DeploymentPackage-RequiredStorage: 15

#### 114.3.4.7 **Bundle-SymbolicName (Name Section)**

The Bundle-SymbolicName header must be a copy of the Bundle-SymbolicName header in the named bundle, including any parameters. This header must match the Bundle-SymbolicName of the actual bundle; if it does not, the install or update must fail. The parameters, however, can differ between updates. The header has the following format:

Bundle-SymbolicName: unique-name (';' parameter) \*

If the bundle resource has no Bundle-SymbolicName header, the given symbolic name must be used to calculate the location of the bundle.

For example:

Name: bundles/http.jar

Bundle-SymbolicName: com.acme.http; singleton=true

#### 114.3.4.8 **Bundle-Version (Name Section)**

The Bundle-Version header must be equal to the Bundle-Version header in the named bundle. It must follow the format as defined for the version clause in [2].

Bundle-Version ::= version // See Version in Core

A mismatch between the version indicated in the Manifest of the Deployment Package and the actual value in the Bundle's Manifest must cause an installation or update to fail.

For example

Bundle-Version: 1.2

#### 114.3.4.9 **Resource-Processor (Name Section)**

The Resource-Processor header selects an OSGi Resource Processor service for this resource by selecting the Resource-Processor service with the given PID as service.id service property. This header is optional, so that the Deployment Package can carry resources that are not processed: for example, license and documentation files. The format of the header is:

Resource-Processor ::= pid // See General Syntax Definitions in Core

For example:

```
Name: certificate/certificates.xml
SHA-1-Digest: M78w249126182Ak5zeq2X1Uv-+uF=
Resource-Processor: com.securitas.keystore
```

In the example, the certificates.xml in the certificate directory will be processed by the Resource Processor service registered with the service property service.pid set to com.securitas.keystore. The service.pid is a standard Framework property to uniquely identify a service instance called a Persistent IDentity a.k.a. PID.

#### 114.3.4.10 **DeploymentPackage-Missing (Name Section)**

Fix packs (see *Fix Package* on page 400 ) are Deployment Packages that do not contain all the resources for a full install. This header indicates the Bundle Symbolic Name of a bundle that is not present in the enclosing JAR file but should be part of a prior version of this Deployment Package. The format is:

```
DeploymentPackage-Missing ::= 'true' | 'false'
```

The default value for this header is false. An error results if this header is true and the resource is not present in the existing Deployment Package.

For example:

```
Name: bundles/3dlib.jar
DeploymentPackage-Missing: true
Bundle-SymbolicName: com.acme.http
Bundle-Version: 3.0
```

#### 114.3.4.11 **DeploymentPackage-Customizer (Name Section)**

This header is used to indicated that a resource is a customizer bundle, as described in *Customizer* on page 401. The syntax of this optional header is:

```
DeploymentPackage-Customizer ::= 'true' | 'false'
```

The default for this header is false.

For example:

```
Name: bundles/3dlibcustomizer.jar
DeploymentPackage-Customizer: true
Bundle-SymbolicName: com.acme.customizer
Bundle-Version: 3.6
```

### 114.3.5 **Localization**

All human readable headers can be localized using the same mechanism as is used to localize the manifest of a bundle. This mechanism is described in *Localization* of the [2].

For example, a Manifest could look like:

```
Manifest-Version: 1.0
DeploymentPackage-ManifestVersion: 1
DeploymentPackage-SymbolicName: com.third._3d
DeploymentPacake-Version: 1.2.3.build22032005
DeploymentPackage-Copyright: %copyright
DeploymentPackage-Vendor: %vendor
```

```

DeploymentPackage-License: %licenseurl
DeploymentPackage-Description: %3dlib
DeploymentPackage-Icon: %iconurl
DeploymentPackage-Name: %name
Bundle-Localization: OSGI-INF/l10n/dp
↵
Name: bundles/3dlib.jar
SHA-1-Digest: M0ez1l4gXHBo8ycYdAxstK3UvEg=
Bundle-SymbolicName: com.third_3d
Bundle-Version: 2.3.1
↵
Name: OSGI-INF/autoconf.xml
SHA-1-Digest: M78w24912HgiZv5zeq2X1Uv-+uF=
Resource-Processor: org.osgi.deployment.rp.autoconf
↵
Name: icon_nl.gif
SHA-1-Digest: n72w21124hGiZV5zQeAXxUvaaUf=
↵
Name: OSGI-INF/l10n/dp.properties
SHA-1-Digest: V5zQeAXxUvaaUfn72w21124hGiZ=
↵
Name: OSGI-INF/l10n/dp_nl.properties
SHA-1-Digest: xUvaaUfn72w21124hGiZV5zQeAXx
↵

```

Different language translations can be provided, such as:

```

OSGI-INF/l10n/dp.properties:
copyright=ACME Inc. (c) 2005
vendor=ACME Inc.
license=OSGI-INF/license.en.txt
3dlib=High performance graphic library
name=3D-Lib
icon=http://www.acm.com/3dlib/icon.gif

```

```

OSGI-INF/l10n/dp_nl.properties:
copyright=ACME Holland BV (c) 2005
vendor=ACME Holland BV.
license=OSGI-INF/licentie.txt
3dlib=Zeer snelle 3D grafische routine bibliotheek
icon = icon_nl.gif
name = 3D-Bibliotheek

```

The language translation resources should appear in the Name section of the manifest so they can be signed.

## 114.4 Fix Package

A Fix Package is a Deployment Package that minimizes download time by excluding resources that are not required to upgrade or downgrade a Deployment Package. It can only be installed on a Framework if a previous version of that Deployment Package is already installed. The Fix Package contains only the changed and new resources. A Fix Package (called the *source*) therefore must specify the range of versions that the existing Deployment Package (called the *target*) must have installed. This range is specified with the DeploymentPackage-FixPack header in the manifest of the source.

The Manifest format for a Fix Package is, except for the Fix Package header, the same as for a Deployment Package manifest: each resource must be named in the Name section of the Manifest. Resources that are absent, however, must be marked in the named section with the DeploymentPackage-Missing header set to true.

Thus, the name sections of the manifest of a Fix Package must list *all* resources, absent or present, in order to distinguish between resources that must be removed or resources that are absent. Name sections that specify the DeploymentPackage-Missing header, however, indicate that the actual content of the resource is not carried in the Deployment Package. That is, the resource content is absent. Only a Fix Package is permitted to contain the DeploymentPackage-Missing headers.

For example, the following headers define a valid Fix Package that can update an existing Deployment Package, only if the version is between 1 and 2.

```
Manifest-Version: 1.0
DeploymentPackage-SymbolicName: com.acme.package.chess
DeploymentPackage-Version: 2.1
DeploymentPackage-FixPack: [1,2)
↵
Name: chess.jar
Bundle-SymbolicName: com.acme.bundle.chess
DeploymentPackage-Missing: true
Bundle-Version: 5.7
↵
Name: score.jar
Bundle-SymbolicName: com.acme.bundle.chessscore
Bundle-Version: 5.7
↵
```

In this example, the Fix Package requires that version 1.x.y of the deployment package is already installed. The presence of the com.acme.bundle.chess bundle on the Framework is assumed, and it must be part of the existing Deployment Package com.acme.package.chess. After installation, this Deployment Package must contain the two listed bundles.

## 114.5 Customizer

The standardized Deployment Admin service installation and uninstallation functions do not always cover the needs of a developer. In certain cases, running custom code at install and uninstall time is required. This need is supported with the Deployment Package *Customizer*. Typical Customizer bundles are:

- Database initialization
- Data conversion
- Wiring

A Customizer bundle is indicated by a DeploymentPackage-Customizer header in a Name section for a bundle resource. A Deployment Package can have a number of customizers, or none. A Customizer bundle must be installed and started by the Deployment Admin service *before* any of the resources are processed.

As a Customizer bundle is started, it should register one or more Resource Processor services. These Resource Processor services must only be used by resources originating from the same Deployment Package. Customizer bundles must never process a resource from another Deployment Package, which must be ensured by the Deployment Admin service.

Customizers are installed and started in the order that they appear in the Deployment Package.

### 114.5.1 Bundle's Data File Area

Each bundle in the OSGi Framework has its own persistent private storage area. This private area is accessed by a bundle with the `getDataFile` method on the Bundle Context. The location in the file system where these files are stored is not defined, and thus is implementation-dependent. A Customizer bundle, however, typically needs access to this private storage area.

The Deployment Admin service provides access to the Bundle private storage area with the `getDataFile(Bundle)` method on the `DeploymentSession` object. This method returns a File object to the root of the data directory.

The location of a bundle's private storage area is impossible to determine because it depends on the implementation of the OSGi Framework. It is therefore impossible to give a Customizer bundle an appropriate File Permission for customization of a bundle's data area.

Therefore, if a Customizer bundle calls the `getDataFile` method for a specific bundle, the Deployment Admin must add to the Customizer bundle the required File Permission to access this area. This File Permission must be removed after the session ends.

### 114.5.2 Customizers and Update

The lifecycle of a customizer bundle is intertwined with the lifecycle of the resources it processes. Care should be taken to ensure that updates and uninstallations are handled correctly. A Customizer bundle is updated *before* a resource is processed implying that a deployment session *n* is always dropped or processed by the customizer from session *n+1*. In this case, a session is an install or uninstall of a Deployment or Fix Package.

Figure 114.6 Time line for customizer versus resource versions

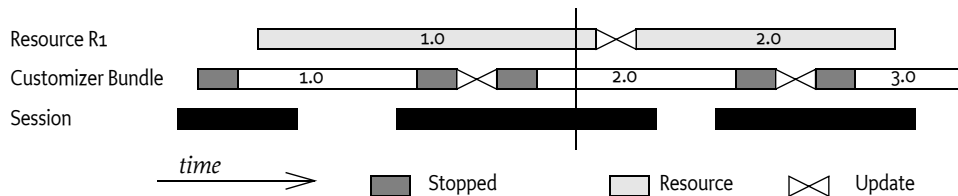

In Figure 114.6, Customizer bundle 2.0 must update the resource from version 1.0, and customizer 3.0 must drop the resource from version 2.0. As a consequence, the Customizer bundle that processes a resource will be a different version than the one that processes or drops it.

The same ordering issue is also relevant with respect to the Autoconf resources (see *Auto Configuration Specification* on page 439). Autoconf resources will not be available until the commit method is called. This condition implies that a customizer cannot receive fresh configuration information from the Deployment Package.

## 114.6 Deployment Admin Service

The Deployment Admin service provides the following services:

- *Introspecting* - Provide information about the Deployment Package repository. Introspecting is further discussed on *Introspection* on page 403.
- *Install* - The installation of a Deployment Package is described in *Installing a Deployment Package* on page 406.
- *Uninstall* - The uninstallation of a Deployment Package is described in *Uninstalling a Deployment Package* on page 411.

- *Canceling* - An ongoing session can be canceled with the cancel method described in *Canceling* on page 404.

An important concept of the Deployment Admin service is the *session*. Installations and uninstalls of Deployment Packages take place inside a session. This session is represented by a `DeploymentSession` object. The session provides access to the Deployment Package that is being (un)installed, as well as access to the data area of bundles. The transactional aspects of this sessions are discussed in *Sessions* on page 404.

### 114.6.1 Introspection

The Deployment Admin service can provide the list of currently installed Deployment Packages with the `listDeploymentPackages()` method. Given a name, it is also possible to get a Deployment Package with `getDeploymentPackage(String)` using the name, or `getDeploymentPackage(Bundle)` for the Deployment Package of a specific bundle.

The `listDeploymentPackages()` method returns an array of `DeploymentPackage` objects. This list of Deployment Packages must contain only valid installed packages. During an installation or upgrade of an existing package, the target must remain in this list until the installation process is complete, after which the source replaces the target. If the installation fails, the source must never become visible, even transiently.

`DeploymentPackage` objects provide access to the following identity information:

- `getName()` - The name of the Deployment Package.
- `getVersion()` - The version of the Deployment Package.

The Deployment Package also provides access to the bundles that are associated with a Deployment Package.

- `getBundleInfos()` - Returns an array of information about all bundles that are *owned* by this Deployment Package. The return type is a `BundleInfo` object that has a `getVersion()` and `getSymbolicName()` method.
- `getBundle(String)` - Returns the bundle with the given Bundle Symbolic Name that is associated with this Deployment Package. As this instance is transient, for example, a bundle can be removed at any time because of the dynamic nature of the OSGi platform, this method may also return null if the bundle is part of this deployment package but is temporarily not defined in the Framework.

The Deployment Package also provides access to the headers in its Manifest. The global section and the Name sections are both supported. This information can be used to provide human-readable information to the end user. If the Manifest is using localization, this information must be returned in the default locale. It is not possible to specify a specific locale. See *Localization* on page 399 for more information.

- `getHeader(String)` - Provides access to the Deployment Package's Manifest header global section. Header names must be matched in a case-insensitive manner.
- `getResourceHeader(String,String)` - Provides access to a header in the Name section. The first argument specifies the resource id (JAR path); the second argument is the (case insensitive) header name.

The Deployment Package contains a number of resources. Each resource can be queried for its associated Resource Processor service.

- `getResourceProcessor(String)` - Return the Service Reference of the Resource Processor service that is associated with the given resource. For a Bundle resource, the returned Resource Processor must be null.

- `getResources()` - Return an array of resource names. This array must include the Bundle resources.

The `isStale()` method returns true when `DeploymentPackage` object is no longer available.

### 114.6.2 Canceling

An ongoing session can be canceled with the Deployment Admin service's `cancel()` method. This method must find the currently executing Resource Processor service and call its `cancel` method. The remainder of the session must be immediately rolled back after the Resource Processor returns from the active method.

## 114.7 Sessions

The (un)installation or upgrade of a deployment package requires the cooperation and interaction of a large number of services. This operation, therefore, takes place in a *session*. A session must be created by the Deployment Admin service before any activity on behalf of the Deployment Package takes place, including any bundle installations. Sessions are not visible to the clients of Deployment Admin service.

Before using a resource processor in a session, the Deployment Admin service must *join* the Resource Processor service to the session. The `begin(DeploymentSession)` method must be called before a Resource Processor service calls the `process`, `drop`, or `dropAllResources` method. For brevity, this joining is not shown in the following sections, but must be assumed to have taken place before any of the methods is called.

A Resource Processor has *joined the session* when it has returned from its `begin(DeploymentSession)` method without an Exception being thrown. A Resource Processor service must not be joined to more than a single session at any moment in time implying that a Resource Processor can assume that only one install takes place at a time.

A roll back can take place at any moment during a session. It can be caused by a Resource Processor service that throws an Exception during a method call, or it can be caused by canceling the session (see *Canceling* on page 404).

If all methods in a session are executed without throwing Exceptions, then the session must be committed. Commitment first requires a vote about the outcome of the session in the so-called *prepare* phase. The Deployment Admin service must therefore call the `prepare` method on all Resource Processor services that have joined the session. The Resource Processor services must be called in the reverse order of joining.

Any Resource Processor that wants to roll back the session in the prepare phase can, at that moment, still throw an Exception. The `prepare` method can also be used to persist some of the changes, although the possibility remains that the session will be rolled back and that those changes must then be undone.

If all joined Resource Processors have successfully executed the `prepare` method, the Deployment Admin service must call the `commit` method on all Resource Processor services that have joined the session. The Resource Processor services must be called in the reverse order of joining. Resource Processor services must not throw an Exception in this method; they should only finalize the commit. Any Exceptions thrown should be logged, but must be ignored by the Deployment Admin service.

### 114.7.1 Roll Back

At the moment of the roll back, a number of Resource Processor services can have joined the session and bundles could have been installed. For each of these joined Resource Processor services, the Deployment Admin service must call the `rollback()` method. A roll back can be caused by a thrown Ex-



ception during an operation, or can be initiated by the caller. The roll back can even happen after the `prepare()` method has been called if another Resource Processor throws an Exception in its prepare method. The Resource Processor services must be called in the reverse order of joining for the rollback method.

The system should make every attempt to roll back the situation to its pre-session state:

- Changed artifacts must be restored to their prior state
- New artifacts must be removed
- Stale artifacts must be created again
- Any installed or updated bundles must be removed
- The state of the target bundles must be restored

If the target bundles were started before, and the state can be restored successfully, the target bundles must be refreshed and started again before the method returns.

If the roll back cannot completely restore the state of the target bundles, the target bundles that were restored must not be restarted, in order to prevent running bundles with incompatible versions. An appropriate warning should be logged in this case.

After the commit or rollback method, the `DeploymentAdminSession` object is no longer usable.

The transactional aspects of the session are depicted in Figure 114.7.

Figure 114.7 Transactional Sessions

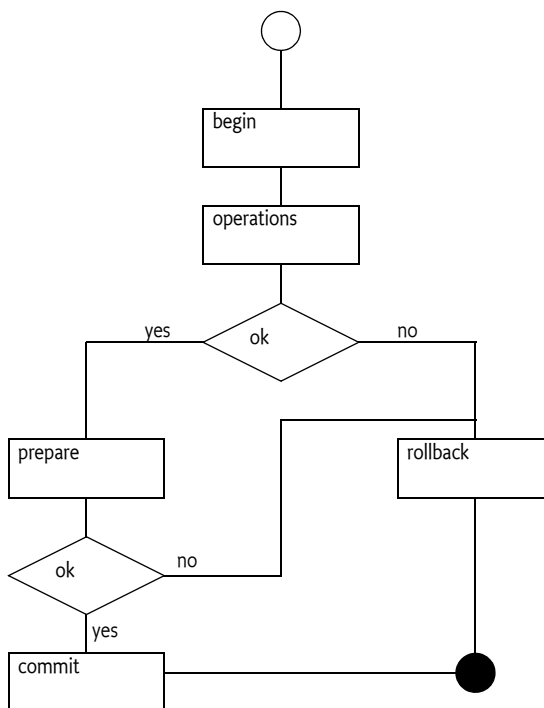

The Deployment Admin service must uninstall any new bundles and install *stale* bundles (bundles that were uninstalled during the session), and should roll back updated bundles. Rolling back a bundle update, as well as reinstalling a stale bundle, requires an implementation-dependent back door into the OSGi Framework, because the Framework specification is not transactional over multiple lifecycle operations. Therefore, this specification does not mandate full transactional behavior.

After a roll back, however, a Deployment Package must still be removable with all its resources and bundles dropped. A roll back must not bring the Deployment Package to a state where it can no longer be removed, or where resources become orphaned.

### 114.7.2 Bundle Events During Deployment

Deployment operations usually result in bundles being installed or uninstalled. These deployment operations can fail in mid-operation, and cause a roll back by Deployment Admin meaning that the platform can go through some transient states in which bundles are installed, then uninstalled due to roll back.

Therefore, the order of Bundle events produced by a transactional implementation must be compatible with the Bundle events produced by a non-transactional implementation. A transactional implementation, however, can choose to postpone all events while maintaining ordering until the end of the session and thereby canceling any events that cancel each other (e.g. install and uninstall). A non-transactional Deployment Admin service must send out the events as they occur.

In the following example, a simple Deployment Package consists of bundles A, B, and C. If this Deployment Package is successfully installed, an implementation must produce the following Bundle events (in order):

1. BundleEvent(INSTALLED) for bundle A
2. BundleEvent(INSTALLED) for bundle B
3. BundleEvent(INSTALLED) for bundle C

If an operation of this Deployment Package was unsuccessful because, for example, Bundle C could not be installed due to an error, then the Deployment Admin service must roll back the deployment operation to return the platform to its original state. If the Deployment Admin service is transactional, then it must not expose the events because no persistent bundle changes were made to the platform.

On the other hand, a non-transactional implementation must expose the transient bundle states that occur during the deployment operation. In this case, the following bundle events could have been generated (in order):

1. BundleEvent(INSTALLED) for bundle A
2. BundleEvent(INSTALLED) for bundle B
3. BundleEvent(UNINSTALLED) for bundle A
4. BundleEvent(UNINSTALLED) for bundle B

## 114.8 Installing a Deployment Package

Installation starts with the `installDeploymentPackage(InputStream)`. No separate function exists for an update; if the given Deployment Package already exists, it must be replaced with this new version. The purpose of the `installDeploymentPackage` method is to replace the *target* Deployment Package (existing) with the *source* Deployment Package (contained in the Input Stream).

The `InputStream` object must stream the bytes of a valid Deployment Package JAR; it is called the *source* deployment package. The `InputStream` object must be a general `InputStream` object and not an instance of the `JarInputStream` class, because these objects do not read the JAR file as bytes.

If an installed Deployment Package has the same name as the source, it is called the *target* Deployment Package. If no target exists, an invisible empty target with a version of 0.0.0 must be assumed without any bundles and resources.

The installation of a deployment package can result in these qualifications for any resource  $r$ :

- $r \in source, r \notin target$  - New resource

- $r \notin source, r \in target$  - Stale resource
- $r \in source, r \in target$  - Updated resource

The short scenario for an install is depicted in Figure 114.8.

Figure 114.8 Overview of install process

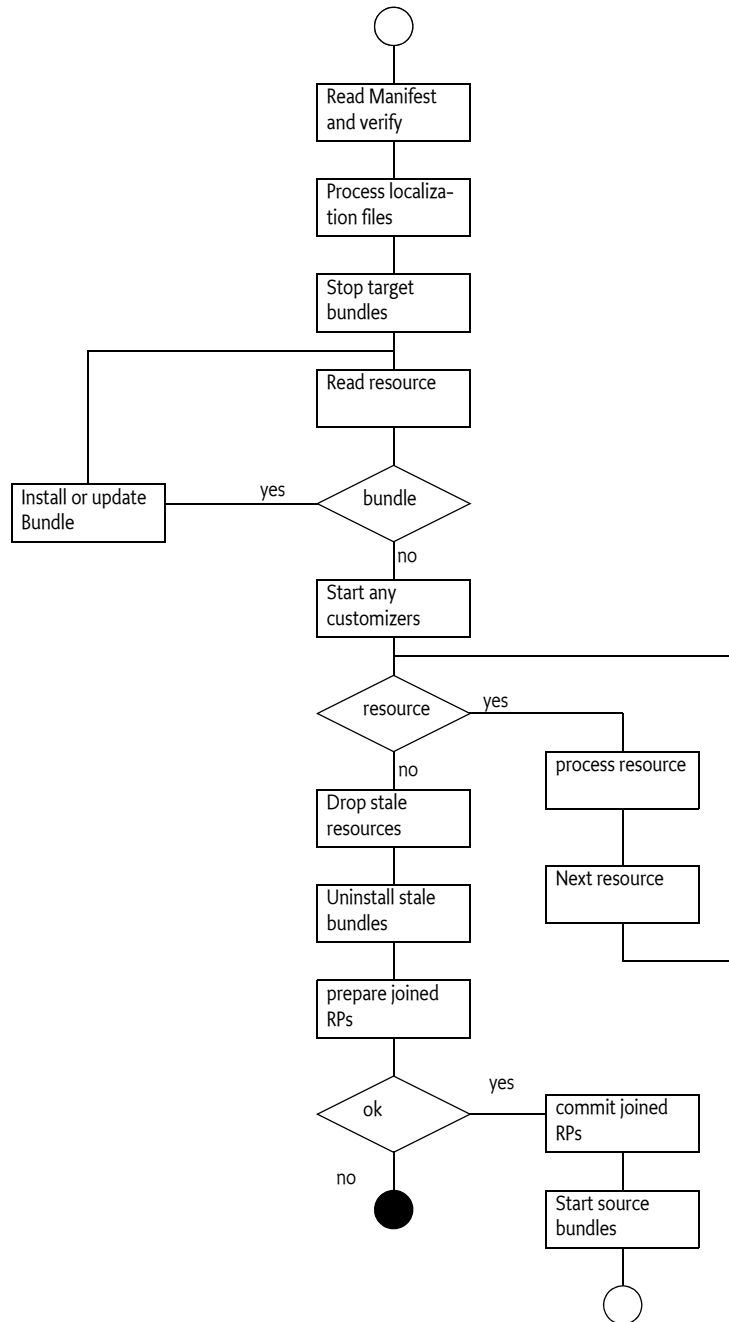

In more detail, to install a Deployment Package, a Deployment Admin service must:

1. Create a Deployment Session
2. Assert that the Manifest file is the first resource in the Deployment Package JAR file.

3. Assert the following:
  - The source must not contain any bundle that exists in other deployment packages, except for the target. The source bundles, as defined by the symbolic name, must belong to the target or be absent.

If the source is a Fix Package, assert that:

- The version of the target matches the required source version range.
- All the missing source bundles are present in the target.

Otherwise:

- Assert that there are no missing resources or bundles declared.

4. Process the localization files, see *Localization* on page 399.
5. All target bundles must be stopped in reverse target resource order. Exceptions thrown during stopping must be ignored, but should be logged as warnings.

The target is now stopped; none of its bundles are running any longer. The next step requires the sequential processing of the resources from the source JAR file in source resource order. The bundles must be processed first (if present), and can be followed by any number of resources, or none.

For each bundle read from the source JAR stream:

6. If the bundle symbolic name already exists in the system with a different version number, update that bundle with the resource stream. If the version is identical, the resource stream must be ignored. The update method must follow the semantics of the OSGi Framework update method. An exception thrown during the update must roll back the session.

Otherwise, install the bundle according to the semantics of the OSGi Framework `installBundle` method. The location of the bundle must be set to the Bundle Symbolic Name without any parameters and be prefixed with the `osgi-dp:` scheme. An exception thrown during the install must roll back the session.

Framework events are discussed in *Bundle Events During Deployment* on page 406.

7. Assert that the installed bundle has the Bundle Symbolic Name and version as defined by the source manifest. If not, the session must be rolled back.

All the source's bundles are now installed or updated successfully. Next, any customizers must be started so that they can participate in the resource processing:

8. If Customizer bundles or stale customizers are defined, start them. If any Customizer bundle's start method throws an exception, the session must be rolled back.

For each resource read from the JAR stream:

9. Find the Resource Processor service that processes the resource by using the PID in the Resource-Processor header. If it cannot be found, the session must be rolled back.
10. Assert that the matched Resource Processor service is not from a Customizer bundle in another Deployment Package.
11. Call the matched Resource Processor service `process(String,InputStream)` method. The argument is the JAR path of the resource. Any Exceptions thrown during this method must abort the installation.

All resource updates and installs have now occurred. The next steps must remove any stale resources. First the stale resources are dropped, and then the bundles are uninstalled. Exceptions are ignored in this phase to allow repairs to always succeed, even if the existing package is corrupted.

12. In reverse target order, drop all the resources that are in the target but not in the source by calling the matching Resource Processor service `dropped(String)` method. Any exceptions thrown during this method should be logged as warnings, but must be ignored.

13. Uninstall all stale bundles in reverse target order, using the OSGi Framework `uninstall` method semantics. Any exceptions thrown should be logged as warnings, but must be ignored.

The deployment package is now cleaned up, and can be activated and committed.

14. All the Resource Processor services that have joined the session must now prepare to commit, which is achieved by calling the `prepare()` method. If any Resource Processor throws an Exception, the session must roll back. The Resource Processors must be called in the reverse order of joining.
15. If all the Resource Processors have successfully prepared their changes, then all the Resource Processor services that have joined the session must now be committed, which is achieved by calling the `commit()` method. The Resource Processors must be called in the reverse order of joining. Any exceptions should be logged as warnings, but must be ignored.
16. Refresh the bundles so that any new packages are resolved.
17. Wait until the refresh is finished.
18. Start the bundles in the source resource order. Exceptions thrown during the start must be logged, but must not abort the deployment operation.

The session is closed and the source replaces the target in the Deployment Admin service's repository.

The `installDeploymentPackage` method returns the source Deployment Package object.

### 114.8.1

#### Example Installation

The target Deployment Package has the following manifest:

```
Manifest-Version: 1.0
DeploymentPackage-SymbolicName: com.acme.daff
DeploymentPackage-Version: 1
↵
Name: bundle-1.jar
Bundle-SymbolicName: com.acme.1
Bundle-Version: 5.7
↵
Name: r0.x
Resource-Processor: RP-x
↵
Name: r1.x
Resource-Processor: RP-x
↵
Name: r1.y
Resource-Processor: RP-y
↵
```

This deployment package is updated with a new version, with the following manifest:

```
Manifest-Version: 1.0
DeploymentPackage-SymbolicName: com.acme.daff
DeploymentPackage-Version: 2
↵
Name: bundle-2.jar
Bundle-SymbolicName: com.acme.2
Bundle-Version: 5.7
↵
Name: r1.x
```

```

Resource-Processor: RP-x
↵
Name: r2.x
Resource-Processor: RP-x
↵
Name: r1.y
Resource-Processor: RP-y
↵

```

The delta between version 1 and version 2 of the `com.acme.daffy` Deployment Package is depicted in Figure 114.9. `Bundle-1` must be uninstalled because it is no longer present in the Deployment Package `com.acme.daffy` version 2. `Bundle-2` is a new bundle and thus must be installed. The resource `ro.x` must be dropped and `r1.x` must be updated (this must be detected and treated accordingly by Resource Processor `RP-x`). `r2.x` is a new resource. The resource `r1.y` is updated by Resource Processor `RP-y`.

Figure 114.9 Delta

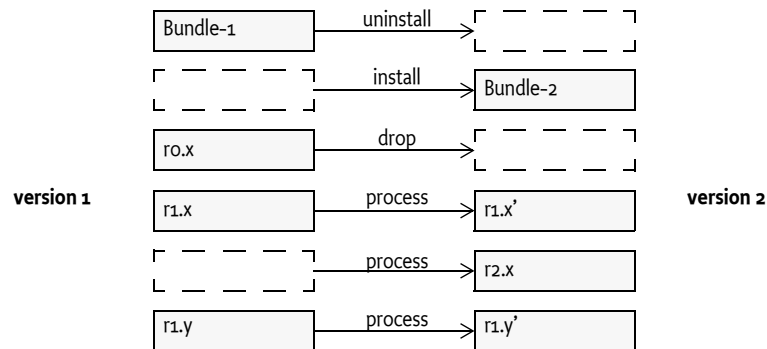

The sequence diagram for the installation is shown in Figure 114.10.

Figure 114.10 Sequence Diagram for a Resource Processor

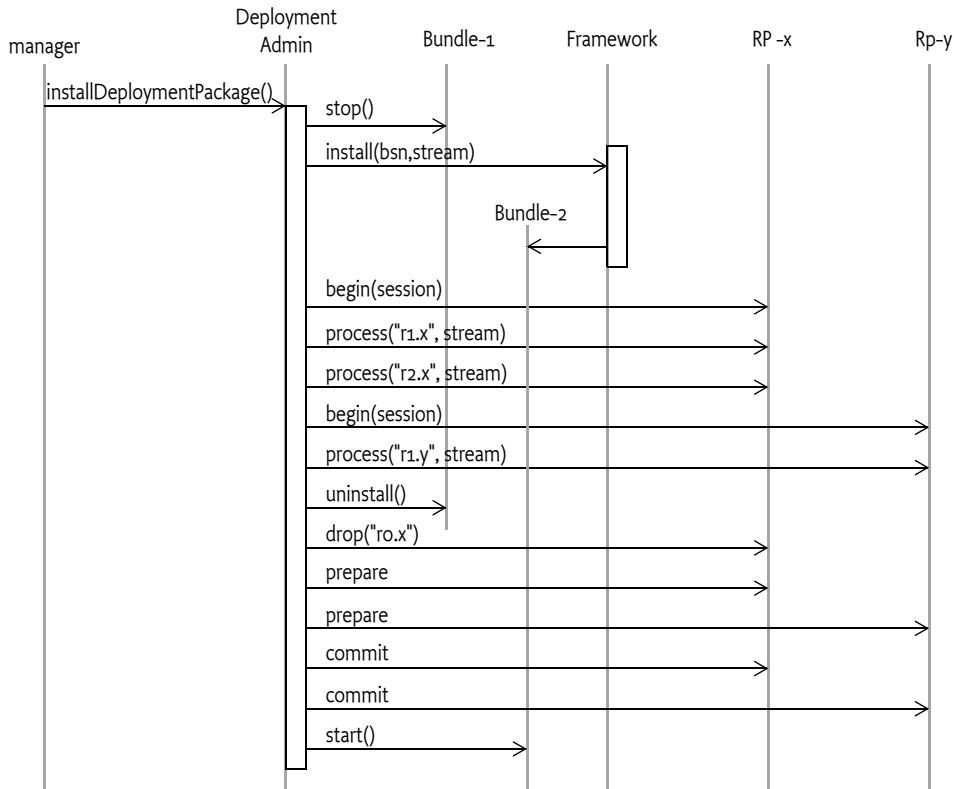

## 114.9 Uninstalling a Deployment Package

Uninstalling a Deployment Package must remove all the effects of its installation(s). The uninstall is started by calling `uninstall()` or `uninstallForced()` method on a *target* `DeploymentPackage` object.

The Deployment Packages are uninstalled explicitly, which may break the overall runtime configuration. No attempt is made to ensure that the uninstalled Deployment Package is required as a provider of Java packages or services, or fulfills other dependencies.

The Deployment Admin service must take the following actions to remove the target Deployment Package when `uninstall()` is called. This procedure must run inside a Deployment Admin session. A Resource Processor that is called must first join the session as described in *Sessions* on page 404.

Uninstalling is composed of the following steps:

1. Start a new Deployment Admin session.
2. Stop all the bundles owned by the Deployment Package. If this step throws a Bundle Exception, this error should be logged but must be ignored.
3. Call the `dropAllResources()` method on all the Resource Processor services that are owned by this Deployment Package. Absent Resource Processor services or Exceptions that are thrown must immediately roll back this session.
4. Call the `prepare` method on the Resource Processor services that joined the session. If any Resource Processor service throws an Exception, the session must be rolled back.
5. Call the `commit` method on the Resource Processors that joined the session.
6. Uninstall all owned bundles.

Uninstalling a Deployment Package can break the overall runtime configuration. No attempt is made to ensure that a Deployment Package being uninstalled is not necessary as a provider of Java packages or services, or fulfills other dependencies.

An error condition results if the Resource Processor services are no longer present when uninstalling or updating a deployment package. A request to carry out an uninstall operation on such a Deployment Package must be refused until the Resource Processor services are all available. A means must be provided, however, to handle permanent unavailability of these services.

To address this issue, the `DeploymentPackage` interface provides a method, `uninstallForced()`, which forces removal of the Deployment Package from the repository maintained by the Deployment Admin service. This method follows the same steps described earlier. Any errors, or the absence of Resource Processor services, should be logged but ignored; they must not cause a roll back.

If errors occur or Resource Processor services are absent, it is likely that the uninstallation will be incomplete, and that some residual artifacts will remain on the platform. Whether this residue is eventually cleaned up, and how, is left up to the implementation.

## 114.10 Resource Processors

The Resource Processor service interprets the byte stream of a resource. Typically, the stream is parsed and its information is stored as *artifacts*. Examples of resource processors are:

- *Configuration Management* - This processor is standardized by the OSGi and more information can be found in *Auto Configuration Specification* on page 439.
- *Certificate Keystore* - A Certificate Keystore processor could extract certificates from a bundle and install them in a keystore.
- *SyncML Script* - Execute a series of SyncML commands.

The Deployment Admin service maintains the list of *resource ids* (the path name in the JAR) that are contained in a Deployment Package. Each resource is uniquely identified within a Deployment Package by its path name hence the term "resource id." The Deployment Package's `getResources()` method provides a list of the resources ids.

The Resource Processor service is responsible for actually creating and deleting the resource related artifacts. The Resource Processor service must be able to remove the artifacts related to a resource that is being dropped using only the resource id.

The `ResourceProcessor` interface is based on a session (see *Sessions* on page 404). The transactionality is limited to the bracketing of any processing or dropping of resources. The bracketing begins when a Resource Processor joins an install session. A Resource Processor service can assume that it is never in two sessions at the same time (see *Threading* on page 417). It can, however, be called multiple times during the session to process different resources.

Before the Resource Processor service is used in an install or uninstall session, the Deployment Admin service must call the `begin(DeploymentSession)` method; this action makes the Resource Processor service join the session. This method must be used by the Resource Processor service to mark any changes for potential roll back, from this time until the `prepare()` / `commit()` or `rollback()` method is called.

When the session is opened, the Deployment Admin service can call the following methods on the Resource Processor service:

- `process(String,InputStream)` - The Resource processor must parse the Input Stream and persistently associate the resulting artifacts with the given resource id. It must be possible to remove those artifacts in a future time, potentially after a complete system restart. Keep in mind that a resource can be processed many times. A Deployment Package that updates to a newer version is



likely to contain the same resources again. Care should be taken to ensure that these updates are real updates and do not add new, unwanted artifacts.

- `dropped(String)` - The artifacts that were associated with the given resource id must be removed. If the named resource does not exist, a warning should be logged but no Exception should be thrown.
- `dropAllResources()` - Remove all artifacts that are related to the current target Deployment Package. This method is called when a Deployment Package is uninstalled.
- `cancel()` - This method is called when the Resource Processor is in the `process(String,InputStream)`, `dropped(String)` or `dropAllResources()` method, allowing the caller to cancel a long-running session. In that case, the Deployment Admin must call the `cancel()` method for the active Resource Processor service. The Resource Processor service should terminate its action as quickly as possible. The Resource Processor service must still handle a roll back of the session after it has returned.

All methods must perform any integrity checks immediately and throw an Exception with an appropriate code if the verification fails. These checks must not be delayed until the prepare or commit method. As stated earlier, changes must be recorded, but it should be possible to roll back the changes when the rollback method is called.

Deployment Packages can be upgraded or downgraded. Resource Processor services must therefore be capable of processing resources that have a lower, equal, or higher version.

### 114.10.1 Example Resource Processor

An example is a Resource Processor service that wires services with the Wire Admin service. The Wire Admin service creates wires between a *producer* and a *consumer* service, each identified by a PID. Wires are the artifacts that are installed and removed. Each wire contains a Dictionary object that is a convenient place to tag wires with the Deployment Package name and resource id. The Wire Admin stores this information persistently, which makes it very suitable for use in a transactional model. This small example supports full transactionality, although without crash recovery.

For simplicity, the wire definitions are stored in a format compatible with the `java.util.Properties` format (because it can simply be loaded from an `InputStream` object). The key is the producer and the value is the consumer. A sample wiring could look like:

```
com.acme.gps = com.acme.navigation
com.acme.asn = com.acme.navigation
com.acme.navigation = com.acme.poi
```

This wiring is depicted in Figure 114.11.

Figure 114.11 Sample Wiring

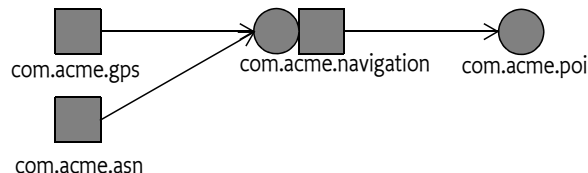

This resource is stored in a Deployment Package JAR file. In this example there are no bundles, so the Deployment Package's manifest would look like:

```
Manifest-Version: 1.0
DeploymentPackage-SymbolicName: com.acme.model.E45.wiring
DeploymentPackage-Version: 1.2832
↵
```

```
Name: sample.wiring
Resource-Processor: wire.admin.processor
↵
```

To reduce the size of the code in this example, the Wire Admin service is received as a parameter. The constructor registers the object as a Resource Processor service with the required `wire.admin.processor` PID.

The transaction strategy of this code is to create wires when new wires have to be created, but to delay the deletion of wires until the end of the session. Any created wires are kept in the `createdWires` field, and the wires that are to be deleted are kept in the `toBeDeletedWires` field.

The current `DeploymentPackage` object is saved in the `current` field when the `begin` method is called.

```
public class WireAdminProcessor implements ResourceProcessor {
    WireAdmin      admin;
    DeploymentPackage current;
    List          createdWires      = new Vector();
    List          toBeDeletedWires = new Vector();

    public WireAdminProcessor(
        WireAdmin admin, BundleContext context)
        throws Exception {
        this.admin = admin;
        Dictionary properties = new Hashtable();
        properties.put(Constants.SERVICE_PID,
            "wire.admin.processor");
        context.registerService(
            ResourceProcessor.class.getName(), this,
            properties);
    }
}
```

When the Deployment Admin service is installing a Deployment Package JAR, it must call the Resource Processor service's `begin` method before the first time it calls a Resource Processor service to join it to the current session. In this case, only the source `DeploymentPackage` object is saved in the `current` field.

```
public void begin(DeploymentSession session){
    current = session.getSourceDeploymentPackage();
}
```

The most complicated method that must be implemented is the `process` method. This method receives the resource id and an input stream with the contents. In this case, the stream is easily converted to a `java.util.Properties` object that contains the definitions of the wires.

The key and value of the `Properties` object are the producer and consumer respectively, which are used to create new wires. Each wire has a `Dictionary` object in the Wire Admin service. This `Dictionary` object is used to store the following properties:

- `deployment.package` - The symbolic name of the current (target) deployment package. This property associates the wire with a specific deployment package.
- `resource.id` - The resource id, or JAR path name. This id associates the specific resource with the wire.

Associating these fields with the wire simplifies finding all wires related to a Deployment Package or all wires related to a specific resource id and Deployment Package. The Wire Admin service supports a search method for wires that takes a filter as argument, further simplifying this process.

After a wire is created, it is stored in the `createdWires` list so that the wires can be deleted if the session is rolled back.

The process method looks as follows:

```
public void process(String resourceId, InputStream in)
    throws Exception {
    Properties properties = new Properties();
    properties.load(in);
    Dictionary dict = new Hashtable();
    dict.put("deployment.package", current.getName());
    for (Iterator i = properties.values().iterator();
         i.hasNext();) {
        dict.put("resource.id", resourceId);
        String producer = (String) i.next();
        String consumer = properties.getProperty(producer);
        Wire wire = admin.createWire(producer,
            consumer, dict);
        createdWires.add(wire);
    }
}
```

If a resource is not in the source but is in the target Deployment Package, it must be dropped from the Resource Processor service. The Deployment Admin will call the `dropped(String)` method for those resources. Therefore, the wires that are tagged with the given resource id and Deployment Package name must be deleted.

The Wire Admin service has a convenient function to get all the wires that match a filter. This method is used to list all the wires that belong to the current Deployment Package as well as those that have the matching resource id. This array is added to the `toBeDeletedWires` field so that it can be deleted when the session is successfully completed. That is, wires are not deleted until the commit phase. When the session is rolled back, the list of wires to be deleted can be discarded, because they were never really deleted.

```
public void dropped(String name) throws Exception{
    List list = getWires(
        "&(resource.id=" + name + ") (deployment.package="
        + current.getName() + ")");
    toBeDeletedWires.addAll(list);
}
```

If the session concludes without errors, the Deployment Admin service must call the `prepare()` method. In this example, it is possible to roll back the persistent changes made so far. The method can therefore just return.

```
public void prepare() {}
```

The `commit()` method must now actually delete the wires that were removed during the session. After these wires are deleted, the method can throw away the list of wires that were created. This list was only kept to remove the wires in case of a roll back.

```
public void commit() {
    delete(toBeDeletedWires);
    toBeDeletedWires.clear();
    createdWires.clear();
}
```

The `rollback()` method is the reverse of the commit. Any created wires must now be deleted to undo their creations in this session. The wires that are to be deleted can now be discarded, because they have not been deleted yet and therefore do not have to be rolled back.

```
public void rollback() {
    delete(createdWires);
    toBeDeletedWires.clear();
    createdWires.clear();
}
```

The `dropAllResources()` method must drop all the wires that were created on behalf of the current Deployment Package. The filter on the `getWires` method makes this process very straightforward. Just delete all the wires that were tagged with the Deployment Package name.

```
public void dropAllResources() {
    List list = getWires("(deployment.package="
        + current.getName() + ")");
    toBeDeletedWires.addAll(list);
}
```

The `cancel()` method must cancel ongoing operations. This example does not have any long-running operations. The cancel method can therefore just return.

```
public void cancel() {}
```

And finally, some helper methods should be self-explanatory.

```
void delete(List wires) {
    while (! wires.isEmpty() )
        admin.deleteWire((Wire) wires.remove(0));
}

List getWires(String filter) {
    try {
        Wire[] wires = admin.getWires(filter);
        return Arrays.asList(wires);
    }
    catch (InvalidSyntaxException ise) {
        ise.printStackTrace();
    }
    return new Vector();
}
```

This example is obviously not an "industrial-strength" implementation; its only purpose is to highlight the different problems that must be addressed. Implementers should therefore consider the following additional issues when implementing a Resource Processor service.

- Changes could have been made to the Deployment Package objects when a Resource Processor's bundle was updated or has been offline for some time, which can happen when the `uninstall-Forced` method has been used. The Deployment Admin service can provide sufficient information to verify its repository to the information maintained in the Resource Processor service.
- A Resource Processor service should have a strategy for transactions that can handle crash recovery. For example, in the previous code the list of `createdWires` and `toBeDeletedWires` should have been logged. Logging these lists would have allowed full crash recovery.
- Better file formats should be considered. The `Properties` class is too restrictive because it can only have a single wire per `Producer` object. The `Properties` class was only chosen for its convenience.

- Multi-threading issues may exist with the cancel method.

## 114.11 Events

The Deployment Admin service must publish several generic events to the Event Admin service in the course of a deployment operation. The purpose of these events is to allow, for example, a user interface to display the progress of a deployment operation to the user.

The topics to which Deployment Admin publishes events are:

- `org/osgi/service/deployment/INSTALL` - The `installDeploymentPackage(InputStream)` method has been called.
- `org/osgi/service/deployment/UNINSTALL` - The `uninstall()` or `uninstallForced()` method has been called.
- `org/osgi/service/deployment/COMPLETE` - The deployment operation has completed.

The INSTALL, UNINSTALL and COMPLETE events have the following property:

- `EVENT_DEPLOYMENTPACKAGE_NAME` - (String) The name of the Deployment Package. This name is the same name as that specified in the `DeploymentPackage-SymbolicName` Manifest header.
- `EVENT_DEPLOYMENTPACKAGE_READABLENAME` - (String)
- `EVENT_DEPLOYMENTPACKAGE_CURRENTVERSION` - (Version) The currently installed version of the Deployment Packages. This attribute is only present when there is a version of the Deployment Package installed before the method that generated the event.
- `EVENT_DEPLOYMENTPACKAGE_NEXTVERSION` - (Version) The version of Deployment Package after the successful completion of the install operation.

The COMPLETE event additionally has the following property:

- `successful` - (Boolean) Whether the deployment operation was successful or not.

## 114.12 Threading

The Deployment Admin service must be a singleton and must only process a single session at a time. When a client requests a new session with an install or uninstall operation, it must block that call until the earlier session is completed. The Deployment Admin service must throw a `DeploymentException` when the session cannot be created after an appropriate time-out period. Resource Processor services can thus assume that all calls from `begin` to `commit` or `rollback` methods are called from the same thread.

Special care should be taken with the cancel method that is usually called from another thread.

## 114.13 Security

### 114.13.1 Deployment Admin Permission

The Deployment Admin Permission is needed to access the methods of the Deployment Admin service. The target for a Deployment Admin Permission is the same Filter string as for an Admin Permission, see *Admin Permission* of [2].

The actions are:

- **LIST** - The permission to call the `listDeploymentPackages()` method and `getDeploymentPackage(String)`.
- **INSTALL** - Allowed to call the `installDeploymentPackage(InputStream)` method.
- **UNINSTALL** - Allowed to call the `uninstall()` method.
- **UNINSTALL\_FORCED** - Allowed to call the `uninstallForced()` method.
- **CANCEL** - Allowed to cancel an ongoing session.
- **METADATA** - Provide access to the Deployment Package meta data.

### 114.13.2 Deployment Customizer Permission

The `DeploymentCustomizerPermission` is used by customizer bundles. The target is the same as the target of Admin Permission: a filter that selects bundles. It has the following action:

- **PRIVATEAREA** - Permits the use of the private area of the target bundles.

### 114.13.3 Permissions During an Install Session

Unprotected, Resource Processor services can unwittingly disrupt the device by processing incorrect or malicious resources in a Deployment Package. In order to protect the device, Resource Processor service's capabilities must be limited by the permissions granted to the union of the permissions of the Deployment Package's *signers*. This union is called the *security scope*. Given a signer, its security scope can be obtained from the *Conditional Permission Admin Service Specification*.

The Deployment Admin service must execute all Resource Processor service calls inside a `doPrivileged` block. This privileged block must use an `AccessControlContext` object that limits the permissions to the security scope. Therefore, a Resource Processor service must assume that it is always running inside the correct security scope. A Resource Processor can, of course, use its own security scope by doing a local `doPrivileged` block.

Bundle life cycle operations (install, uninstall, update) must be performed with the permissions granted to the Deployment Admin service implementation, they should not be further scoped because this could make it impossible to install unsigned Deployment Packages.

### 114.13.4 Contained Bundle Permissions

Bundles can be signed independently from the vehicle that deployed them. As a consequence, a bundle can be granted more permissions than its parent Deployment Package.

### 114.13.5 Service Registry Security

#### 114.13.5.1 Deployment Admin Service

The Deployment Admin service is likely to require All Permission. This requirement is caused by the plugin model. Any permission required by any of the Resource Processor services must be granted to the Deployment Admin service as well. This set is large and difficult to define. The following list, however, shows the minimum permissions required if the permissions for the Resource Processor service permissions are ignored.

|                   |                     |            |
|-------------------|---------------------|------------|
| ServicePermission | ..DeploymentAdmin   | REGISTER   |
| ServicePermission | ..ResourceProcessor | GET        |
| PackagePermission | ..deployment        | EXPORTONLY |

#### 114.13.5.2 Resource Processor

|                   |                     |          |
|-------------------|---------------------|----------|
| ServicePermission | ..DeploymentAdmin   | GET      |
| ServicePermission | ..ResourceProcessor | REGISTER |
| PackagePermission | ..deployment        | IMPORT   |

**114.13.5.3****Client**

|                   |                   |        |
|-------------------|-------------------|--------|
| ServicePermission | ..DeploymentAdmin | GET    |
| PackagePermission | ..deployment      | IMPORT |

**114.14 org.osgi.service.deploymentadmin**

Deployment Admin Package Version 1.1.

Bundles wishing to use this package must list the package in the Import-Package header of the bundle's manifest. This package has two types of users: the consumers that use the API in this package and the providers that implement the API in this package.

Example import for consumers using the API in this package:

```
Import-Package: org.osgi.service.deploymentadmin; version="[1.1,2.0)"
```

Example import for providers implementing the API in this package:

```
Import-Package: org.osgi.service.deploymentadmin; version="[1.1,1.2)"
```

**114.14.1****Summary**

- BundleInfo - Represents a bundle in the array given back by the DeploymentPackage.getBundleInfos() method.
- DeploymentAdmin - This is the interface of the Deployment Admin service.
- DeploymentAdminPermission - DeploymentAdminPermission controls access to the Deployment Admin service.
- DeploymentException - Checked exception received when something fails during any deployment processes.
- DeploymentPackage - The DeploymentPackage object represents a deployment package (already installed or being currently processed).

**114.14.2****public interface BundleInfo**

Represents a bundle in the array given back by the DeploymentPackage.getBundleInfos() method.

**114.14.2.1****public String getSymbolicName()**

- Returns the Bundle Symbolic Name of the represented bundle.

*Returns* the Bundle Symbolic Name

**114.14.2.2****public Version getVersion()**

- Returns the version of the represented bundle.

*Returns* the version of the represented bundle

**114.14.3****public interface DeploymentAdmin**

This is the interface of the Deployment Admin service.

The OSGi Service Platform provides mechanisms to manage the life cycle of bundles, configuration objects, permission objects, etc. but the overall consistency of the runtime configuration is the responsibility of the management agent. In other words, the management agent decides to install, update, or uninstall bundles, create or delete configuration or permission objects, as well as manage other resource types, etc.

The Deployment Admin service standardizes the access to some of the responsibilities of the management agent. The service provides functionality to manage Deployment Packages (see Deploy-

mentPackage). A Deployment Package groups resources as a unit of management. A Deployment Package is something that can be installed, updated, and uninstalled as a unit.

The Deployment Admin functionality is exposed as a standard OSGi service with no mandatory service parameters.

#### 114.14.3.1 **public boolean cancel()**

- This method cancels the currently active deployment session. This method addresses the need to cancel the processing of excessively long running, or resource consuming install, update or uninstall operations.

*Returns* true if there was an active session and it was successfully canceled.

*Throws* SecurityException– if the caller doesn't have the appropriate DeploymentAdminPermission("<filter>", "cancel") permission.

*See Also* DeploymentAdminPermission

#### 114.14.3.2 **public DeploymentPackage getDeploymentPackage(String symbName)**

*symbName* the symbolic name of the Deployment Package to be retrieved. It mustn't be null.

- Gets the currently installed DeploymentPackage instance which has the given symbolic name. During an installation of an existing package (update) or during an uninstallation, the target Deployment Package must remain the return value until the installation (uninstallation) process is completed, after which the source (or null in case of uninstall) is the return value.

*Returns* The DeploymentPackage for the given symbolic name. If there is no Deployment Package with that symbolic name currently installed, null is returned.

*Throws* IllegalArgumentException– if the given symbName is null  
SecurityException– if the caller doesn't have the appropriate DeploymentAdminPermission("<filter>", "list") permission.

*See Also* DeploymentPackage, DeploymentAdminPermission

#### 114.14.3.3 **public DeploymentPackage getDeploymentPackage(Bundle bundle)**

*bundle* the bundle whose owner is queried

- Gives back the installed DeploymentPackage that owns the bundle. Deployment Packages own their bundles by their Bundle Symbolic Name. It means that if a bundle belongs to an installed Deployment Packages (and at most to one) the Deployment Admin assigns the bundle to its owner Deployment Package by the Symbolic Name of the bundle.

*Returns* the Deployment Package Object that owns the bundle or null if the bundle doesn't belong to any Deployment Packages (standalone bundles)

*Throws* IllegalArgumentException– if the given bundle is null  
SecurityException– if the caller doesn't have the appropriate DeploymentAdminPermission("<filter>", "list") permission.

*See Also* DeploymentPackage, DeploymentAdminPermission

#### 114.14.3.4 **public DeploymentPackage installDeploymentPackage(InputStream in) throws DeploymentException**

*in* the input stream the Deployment Package can be read from. It mustn't be null.

- Installs a Deployment Package from an input stream. If a version of that Deployment Package is already installed and the versions are different, the installed version is updated with this new version even if it is older (downgrade). If the two versions are the same, then this method simply returns with the old (target) Deployment Package without any action.



- Returns* A `DeploymentPackage` object representing the newly installed/updated `Deployment Package`. It is never null.
- Throws* `IllegalArgumentException`– if the `got InputStream` parameter is null
- `DeploymentException`– if the installation was not successful. For detailed error code description see `DeploymentException`.
- `SecurityException`– if the caller doesn't have the appropriate `DeploymentAdminPermission("<filter>", "install")` permission.
- See Also* `DeploymentAdminPermission`, `DeploymentPackage`, `DeploymentPackage`

#### 114.14.3.5 **public DeploymentPackage[] listDeploymentPackages()**

- Lists the `Deployment Packages` currently installed on the platform.
- `DeploymentAdminPermission("<filter>", "list")` is needed for this operation to the effect that only those packages are listed in the array to which the caller has appropriate `DeploymentAdminPermission`. It has the consequence that the method never throws `SecurityException` only doesn't put certain `Deployment Packages` into the array.
- During an installation of an existing package (update) or during an uninstallation, the target must remain in this list until the installation (uninstallation) process is completed, after which the source (or null in case of uninstall) replaces the target.
- Returns* the array of `DeploymentPackage` objects representing all the installed `Deployment Packages`. The return value cannot be null. In case of missing permissions it may give back an empty array.
- See Also* `DeploymentPackage`, `DeploymentAdminPermission`

#### 114.14.4 **public final class DeploymentAdminPermission extends Permission**

`DeploymentAdminPermission` controls access to the `Deployment Admin` service.

The permission uses a filter string formatted similarly to the `org.osgi.framework.Filter`. The filter determines the target of the permission. The `DeploymentAdminPermission` uses the name and the signer filter attributes only. The value of the signer attribute is matched against the signer chain (represented with its semicolon separated Distinguished Name chain) of the `Deployment Package`, and the value of the name attribute is matched against the value of the "DeploymentPackage-Name" manifest header of the `Deployment Package`. Example:

- (signer=cn = Bugs Bunny, o = ACME, c = US)
- (name=org.osgi.ExampleApp)

Wildcards also can be used:

```
(signer=cn=*, o=ACME, c=*)
```

"cn" and "c" may have an arbitrary value

```
(signer=*, o=ACME, c=US)
```

Only the value of "o" and "c" are significant

```
(signer=* ; ou=S & V, o=Tweety Inc., c=US)
```

The first element of the certificate chain is not important, only the second (the Distinguished Name of the root certificate)

```
(signer=- ; *, o=Tweety Inc., c=US)
```

The same as the previous but '-' represents zero or more certificates, whereas the asterisk only represents a single certificate

(name=\*)

The name of the Deployment Package doesn't matter

(name=org.osgi.\*)

The name has to begin with "org.osgi."

The following actions are allowed:

#### **list**

A holder of this permission can access the inventory information of the deployment packages selected by the <filter> string. The filter selects the deployment packages on which the holder of the permission can acquire detailed inventory information. See `DeploymentAdmin.getDeploymentPackage(Bundle)`, `DeploymentAdmin.getDeploymentPackage(String)` and `DeploymentAdmin.listDeploymentPackages`.

#### **install**

A holder of this permission can install/update deployment packages if the deployment package satisfies the <filter> string. See `DeploymentAdmin.installDeploymentPackage`.

#### **uninstall**

A holder of this permission can uninstall deployment packages if the deployment package satisfies the <filter> string. See `DeploymentPackage.uninstall()`.

#### **uninstall\_forced**

A holder of this permission can forcefully uninstall deployment packages if the deployment package satisfies the <filter> string. See `DeploymentPackage.uninstallForced()`.

#### **cancel**

A holder of this permission can cancel an active deployment action. This action being canceled could correspond to the install, update or uninstall of a deployment package that satisfies the <filter> string. See `DeploymentAdmin.cancel()`

#### **metadata**

A holder of this permission is able to retrieve metadata information about a Deployment Package (e.g. is able to ask its manifest headers). See `org.osgi.service.deploymentadmin.DeploymentPackage.getBundle(String)`, `org.osgi.service.deploymentadmin.DeploymentPackage.getBundleInfos()`, `org.osgi.service.deploymentadmin.DeploymentPackage.getHeader(String)`, `org.osgi.service.deploymentadmin.DeploymentPackage.getResourceHeader(String, String)`, `org.osgi.service.deploymentadmin.DeploymentPackage.getResourceProcessor(String)`, `org.osgi.service.deploymentadmin.DeploymentPackage.getResources()`

The actions string is converted to lower case before processing.

#### **114.14.4.1 public static final String CANCEL = "cancel"**

Constant String to the "cancel" action.

*See Also* `DeploymentAdmin.cancel()`

#### **114.14.4.2 public static final String INSTALL = "install"**

Constant String to the "install" action.

*See Also* DeploymentAdmin.installDeploymentPackage(InputStream)

#### 114.14.4.3 **public static final String LIST = "list"**

Constant String to the "list" action.

*See Also* DeploymentAdmin.listDeploymentPackages(), DeploymentAdmin.getDeploymentPackage(String), DeploymentAdmin.getDeploymentPackage(Bundle)

#### 114.14.4.4 **public static final String METADATA = "metadata"**

Constant String to the "metadata" action.

*See Also* org.osgi.service.deploymentadmin.DeploymentPackage.getBundle(String), org.osgi.service.deploymentadmin.DeploymentPackage.getBundleInfos(), org.osgi.service.deploymentadmin.DeploymentPackage.getHeader(String), org.osgi.service.deploymentadmin.DeploymentPackage.getResourceHeader(String, String), org.osgi.service.deploymentadmin.DeploymentPackage.getResourceProcessor(String), org.osgi.service.deploymentadmin.DeploymentPackage.getResources()

#### 114.14.4.5 **public static final String UNINSTALL = "uninstall"**

Constant String to the "uninstall" action.

*See Also* DeploymentPackage.uninstall()

#### 114.14.4.6 **public static final String UNINSTALL\_FORCED = "uninstall\_forced"**

Constant String to the "uninstall\_forced" action.

*See Also* DeploymentPackage.uninstallForced()

#### 114.14.4.7 **public DeploymentAdminPermission(String name,String actions)**

*name* filter string, must not be null.

*actions* action string, must not be null. "\*" means all the possible actions.

- Creates a new DeploymentAdminPermission object for the given name and action.

The name parameter identifies the target deployment package the permission relates to. The actions parameter contains the comma separated list of allowed actions.

*Throws* IllegalArgumentException– if the filter is invalid, the list of actions contains unknown operations or one of the parameters is null

#### 114.14.4.8 **public boolean equals(Object obj)**

*obj* The reference object with which to compare.

- Checks two DeploymentAdminPermission objects for equality. Two permission objects are equal if:

- their target filters are semantically equal and
- their actions are the same

*Returns* true if the two objects are equal.

*See Also* java.lang.Object.equals(java.lang.Object)

#### 114.14.4.9 **public String getActions()**

- Returns the String representation of the action list.

The method always gives back the actions in the following (alphabetical) order: cancel, install, list, metadata, uninstall, uninstall\_forced

*Returns* Action list of this permission instance. This is a comma-separated list that reflects the action parameter of the constructor.

*See Also* `java.security.Permission.getActions()`

#### 114.14.4.10 **public int hashCode()**

- Returns hash code for this permission object.

*Returns* Hash code for this permission object.

*See Also* `java.lang.Object.hashCode()`

#### 114.14.4.11 **public boolean implies(Permission permission)**

*permission* Permission to check.

- Checks if this `DeploymentAdminPermission` would imply the parameter permission.

Precondition of the implication is that the action set of this permission is the superset of the action set of the other permission. Further rules of implication are determined by the `org.osgi.framework.Filter` rules and the "OSGi Service Platform, Core Specification Release 4, Chapter Certificate Matching".

The allowed attributes are: `name` (the symbolic name of the deployment package) and `signer` (the signer of the deployment package). In both cases wildcards can be used.

Examples:

1. `DeploymentAdminPermission("name=org.osgi.ExampleApp", "list")`
2. `DeploymentAdminPermission("name=org.osgi.ExampleApp", "list, install")`
3. `DeploymentAdminPermission("name=org.osgi.*", "list")`
4. `DeploymentAdminPermission("signer=*, o=ACME, c=US", "list")`
5. `DeploymentAdminPermission("signer=cn=Bugs Bunny, o=ACME, c=US", "list")`

1. implies 1.
2. implies 1.
1. doesn't implies 2.
3. implies 1.
4. implies 5.

*Returns* true if this `DeploymentAdminPermission` object implies the specified permission.

*See Also* `java.security.Permission.implies(java.security.Permission)`, `org.osgi.framework.Filter`

#### 114.14.4.12 **public PermissionCollection newPermissionCollection()**

- Returns a new `PermissionCollection` object for storing `DeploymentAdminPermission` objects.

*Returns* The new `PermissionCollection`.

*See Also* `java.security.Permission.newPermissionCollection()`

### 114.14.5 **public class DeploymentException extends Exception**

Checked exception received when something fails during any deployment processes. A `DeploymentException` always contains an error code (one of the constants specified in this class), and may optionally contain the textual description of the error condition and a nested cause exception.

#### 114.14.5.1 **public static final int CODE\_BAD\_HEADER = 452**

Syntax error in any manifest header.

DeploymentAdmin.installDeploymentPackage(InputStream) throws exception with this error code.

**114.14.5.2**

**public static final int CODE\_BUNDLE\_NAME\_ERROR = 457**

Bundle symbolic name is not the same as defined by the deployment package manifest.

DeploymentAdmin.installDeploymentPackage(InputStream) throws exception with this error code.

**114.14.5.3**

**public static final int CODE\_BUNDLE\_SHARING\_VIOLATION = 460**

Bundle with the same symbolic name already exists.

DeploymentAdmin.installDeploymentPackage(InputStream) throws exception with this error code.

**114.14.5.4**

**public static final int CODE\_CANCELLED = 401**

DeploymentAdmin.installDeploymentPackage(InputStream), DeploymentPackage.uninstall() and DeploymentPackage.uninstallForced() methods can throw DeploymentException with this error code if the DeploymentAdmin.cancel() method is called from another thread.

**114.14.5.5**

**public static final int CODE\_COMMIT\_ERROR = 462**

Exception with this error code is thrown when one of the Resource Processors involved in the deployment session threw a ResourceProcessorException with the CODE\_PREPARE error code.

DeploymentAdmin.installDeploymentPackage(InputStream) and DeploymentPackage.uninstall() methods throw exception with this error code.

**114.14.5.6**

**public static final int CODE\_FOREIGN\_CUSTOMIZER = 458**

Matched resource processor service is a customizer from another deployment package.

DeploymentAdmin.installDeploymentPackage(InputStream) throws exception with this error code.

**114.14.5.7**

**public static final int CODE\_MISSING\_BUNDLE = 454**

A bundle in the deployment package is marked as DeploymentPackage-Missing but there is no such bundle in the target deployment package.

DeploymentAdmin.installDeploymentPackage(InputStream) throws exception with this error code.

**114.14.5.8**

**public static final int CODE\_MISSING\_FIXPACK\_TARGET = 453**

Fix pack version range doesn't fit to the version of the target deployment package or the target deployment package of the fix pack doesn't exist.

DeploymentAdmin.installDeploymentPackage(InputStream) throws exception with this error code.

**114.14.5.9**

**public static final int CODE\_MISSING\_HEADER = 451**

Missing mandatory manifest header.

DeploymentAdmin.installDeploymentPackage(InputStream) can throw exception with this error code.

**114.14.5.10**

**public static final int CODE\_MISSING\_RESOURCE = 455**

A resource in the source deployment package is marked as DeploymentPackage-Missing but there is no such resource in the target deployment package.

DeploymentAdmin.installDeploymentPackage(InputStream) throws exception with this error code.

**114.14.5.11**

**public static final int CODE\_NOT\_A\_JAR = 404**

DeploymentAdmin.installDeploymentPackage(InputStream) methods can throw DeploymentException with this error code if the got InputStream is not a jar.

**114.14.5.12 public static final int CODE\_ORDER\_ERROR = 450**

Order of files in the deployment package is bad. The right order is the following:

1. META-INF/MANIFEST.MF
2. META-INF/\*.SF, META-INF/\*.DSA, META-INF/\*.RS
3. Localization files
4. Bundles
5. Resources

DeploymentAdmin.installDeploymentPackage(InputStream) throws exception with this error code.

**114.14.5.13 public static final int CODE\_OTHER\_ERROR = 463**

Other error condition.

All Deployment Admin methods which throw DeploymentException can throw an exception with this error code if the error condition cannot be categorized.

**114.14.5.14 public static final int CODE\_PROCESSOR\_NOT\_FOUND = 464**

The Resource Processor service with the given PID (see Resource-Processor manifest header) is not found.

DeploymentAdmin.installDeploymentPackage(InputStream), DeploymentPackage.uninstall() and DeploymentPackage.uninstallForced() throws exception with this error code.

**114.14.5.15 public static final int CODE\_RESOURCE\_SHARING\_VIOLATION = 461**

An artifact of any resource already exists.

This exception is thrown when the called resource processor throws a ResourceProcessorException with the CODE\_RESOURCE\_SHARING\_VIOLATION error code.

DeploymentAdmin.installDeploymentPackage(InputStream) throws exception with this error code.

**114.14.5.16 public static final int CODE\_SIGNING\_ERROR = 456**

Bad deployment package signing.

DeploymentAdmin.installDeploymentPackage(InputStream) throws exception with this error code.

**114.14.5.17 public static final int CODE\_TIMEOUT = 465**

When a client requests a new session with an install or uninstall operation, it must block that call until the earlier session is completed. The Deployment Admin service must throw a Deployment Exception with this error code when the session can not be created after an appropriate time out period.

DeploymentAdmin.installDeploymentPackage(InputStream), DeploymentPackage.uninstall() and DeploymentPackage.uninstallForced() throws exception with this error code.

**114.14.5.18 public DeploymentException(int code,String message,Throwable cause)**

*code* The error code of the failure. Code should be one of the predefined integer values (CODE\_X).

*message* Message associated with the exception

*cause* the originating exception

- Create an instance of the exception.

**114.14.5.19 public DeploymentException(int code,String message)**

*code* The error code of the failure. Code should be one of the predefined integer values (CODE\_X).

*message* Message associated with the exception

- Create an instance of the exception. Cause exception is implicitly set to null.

#### 114.14.5.20 **public DeploymentException(int code)**

*code* The error code of the failure. Code should be one of the predefined integer values (CODE\_X).

- Create an instance of the exception. Cause exception and message are implicitly set to null.

#### 114.14.5.21 **public Throwable getCause()**

- Returns the cause of this exception or null if no cause was set.

*Returns* The cause of this exception or null if no cause was set.

#### 114.14.5.22 **public int getCode()**

*Returns* Returns the code.

#### 114.14.5.23 **public Throwable initCause(Throwable cause)**

*cause* The cause of this exception.

- Initializes the cause of this exception to the specified value.

*Returns* This exception.

*Throws* `IllegalArgumentException`– If the specified cause is this exception.

`IllegalStateException`– If the cause of this exception has already been set.

*Since* 1.1

### 114.14.6 **public interface DeploymentPackage**

The `DeploymentPackage` object represents a deployment package (already installed or being currently processed). A Deployment Package groups resources as a unit of management. A deployment package is something that can be installed, updated, and uninstalled as a unit. A deployment package is a reified concept, like a bundle, in an OSGi Service Platform. It is not known by the OSGi Framework, but it is managed by the Deployment Admin service. A deployment package is a stream of resources (including bundles) which, once processed, will result in new artifacts (effects on the system) being added to the OSGi platform. These new artifacts can include installed Bundles, new configuration objects added to the Configuration Admin service, new Wire objects added to the Wire Admin service, or changed system properties, etc. All the changes caused by the processing of a deployment package are persistently associated with the deployment package, so that they can be appropriately cleaned up when the deployment package is uninstalled. There is a strict no overlap rule imposed on deployment packages. Two deployment packages are not allowed to create or manipulate the same artifact. Obviously, this means that a bundle cannot be in two different deployment packages. Any violation of this no overlap rule is considered an error and the install or update of the offending deployment package must be aborted.

The Deployment Admin service should do as much as possible to ensure transactionality. It means that if a deployment package installation, update or removal (uninstall) fails all the side effects caused by the process should be disappeared and the system should be in the state in which it was before the process.

If a deployment package is being updated the old version is visible through the `DeploymentPackage` interface until the update process ends. After the package is updated the updated version is visible and the old one is not accessible any more.

**114.14.6.1**      **public static final String EVENT\_DEPLOYMENTPACKAGE\_CURRENTVERSION = "deploymentpackage.currentversion"**

The currently installed version of the Deployment Package. The attribute is not present, if no version is installed:

- in the INSTALL event, when an installDeploymentPackage was called and no earlier version is present
- in the COMPLETE event after the `_successfully_` completing an uninstallDeploymentPackage call

The value for this event must be a Version object.

*Since* 1.1

**114.14.6.2**      **public static final String EVENT\_DEPLOYMENTPACKAGE\_NAME = "deploymentpackage.name"**

The name of the Deployment Package. This name is the same name as that specified in the DeploymentPackage-SymbolicName Manifest header.

*Since* 1.1

**114.14.6.3**      **public static final String EVENT\_DEPLOYMENTPACKAGE\_NEXTVERSION = "deploymentpackage.nextversion"**

The version of DP after the successful completion of the install operation (used in INSTALL event only). The value for this event must be a Version object.

*Since* 1.1

**114.14.6.4**      **public static final String EVENT\_DEPLOYMENTPACKAGE\_READABLENAME = "deploymentpackage.readablename"**

The human readable name of the DP localized to the default locale.

*Since* 1.1

**114.14.6.5**      **public boolean equals(Object other)**

*other* the reference object with which to compare.

- Indicates whether some other object is "equal to" this one. Two deployment packages are equal if they have the same deployment package symbolic name and version.

*Returns* true if this object is the same as the other argument; false otherwise.

**114.14.6.6**      **public Bundle getBundle(String symbolicName)**

*symbolicName* the symbolic name of the requested bundle

- Returns the bundle instance, which is part of this deployment package, that corresponds to the bundle's symbolic name passed in the symbolicName parameter. This method will return null for request for bundles that are not part of this deployment package.

As this instance is transient (i.e. a bundle can be removed at any time because of the dynamic nature of the OSGi platform), this method may also return null if the bundle is part of this deployment package, but is not currently defined to the framework.

*Returns* The Bundle instance for a given bundle symbolic name.

*Throws* SecurityException— if the caller doesn't have the appropriate DeploymentAdminPermission with "metadata" action

IllegalStateException— if the package is stale



**114.14.6.7 public BundleInfo[] getBundleInfos()**

- Returns an array of BundleInfo objects representing the bundles specified in the manifest of this deployment package. Its size is equal to the number of the bundles in the deployment package.

*Returns* array of BundleInfo objects

*Throws* SecurityException– if the caller doesn't have the appropriate DeploymentAdminPermission with "metadata" action

**114.14.6.8 public String getDisplayName()**

- Returns the Deployment Package human readable name. This method returns the localized human readable name as set with the DeploymentPackage-Name manifest header using the default locale. If no header is set, this method will return null.

*Returns* The human readable name of the deployment package or null if header is not set.

*Since* 1.1

**114.14.6.9 public String getHeader(String header)**

*header* the requested header

- Returns the requested deployment package manifest header from the main section. Header names are case insensitive. If the header doesn't exist it returns null.

If the header is localized then the localized value is returned (see OSGi Service Platform, Mobile Specification Release 4 - Localization related chapters).

*Returns* the value of the header or null if the header does not exist

*Throws* SecurityException– if the caller doesn't have the appropriate DeploymentAdminPermission with "metadata" action

**114.14.6.10 public URL getIcon()**

- Returns a URL pointing to an image that represents the icon for this Deployment Package. The DeploymentPackage-Icon header can set an icon for the deployment package. This method returns an absolute URL that is defined by this header. The Deployment Admin service must provide this icon as a local resource. That is, the Deployment Admin must make a local copy of the specified icon. The returned URL's must point to a local resource.

*Returns* An absolute URL to a local (device resident) image resource or null if not found

*Since* 1.1

**114.14.6.11 public String getName()**

- Returns the Deployment Package Symbolic Name of the package.

*Returns* The name of the deployment package. It cannot be null.

**114.14.6.12 public String getResourceHeader(String resource,String header)**

*resource* the name of the resource (it is the same as the value of the "Name" attribute in the deployment package's manifest)

*header* the requested header

- Returns the requested deployment package manifest header from the name section determined by the resource parameter. Header names are case insensitive. If the resource or the header doesn't exist it returns null.

If the header is localized then the localized value is returned (see OSGi Service Platform, Mobile Specification Release 4 - Localization related chapters).

*Returns* the value of the header or null if the resource or the header doesn't exist

*Throws* `SecurityException`– if the caller doesn't have the appropriate `DeploymentAdminPermission` with "metadata" action

#### 114.14.6.13 **public ServiceReference getResourceProcessor(String resource)**

*resource* the name of the resource (it is the same as the value of the "Name" attribute in the deployment package's manifest)

- At the time of deployment, resource processor service instances are located to resources contained in a deployment package.

This call returns a service reference to the corresponding service instance. If the resource is not part of the deployment package or this call is made during deployment, prior to the locating of the service to process a given resource, null will be returned. Services can be updated after a deployment package has been deployed. In this event, this call will return a reference to the updated service, not to the instance that was used at deployment time.

*Returns* resource processor for the resource or null.

*Throws* `SecurityException`– if the caller doesn't have the appropriate `DeploymentAdminPermission` with "metadata" action

`IllegalStateException`– if the package is stale

#### 114.14.6.14 **public String[] getResources()**

- Returns an array of strings representing the resources (including bundles) that are specified in the manifest of this deployment package. A string element of the array is the same as the value of the "Name" attribute in the manifest. The array contains the bundles as well.

E.g. if the "Name" section of the resource (or individual-section as the Manifest Specification [<http://java.sun.com/j2se/1.4.2/docs/guide/jar/jar.html#Manifest%20Specification>] calls it) in the manifest is the following

```
Name: foo/readme.txt
Resource-Processor: foo.rp
```

then the corresponding array element is the "foo/readme.txt" string.

*Returns* The string array corresponding to resources. It cannot be null but its length can be zero.

*Throws* `SecurityException`– if the caller doesn't have the appropriate `DeploymentAdminPermission` with "metadata" action

#### 114.14.6.15 **public Version getVersion()**

- Returns the version of the deployment package.

*Returns* version of the deployment package. It cannot be null.

#### 114.14.6.16 **public int hashCode()**

- Returns a hash code value for the object.

*Returns* a hash code value for this object

#### 114.14.6.17 **public boolean isStale()**

- Gives back the state of the deployment package whether it is stale or not). After uninstall of a deployment package it becomes stale. Any active method calls to a stale deployment package raise `IllegalStateException`. Active methods are the following:

- `getBundle(String)`

- `getResourceProcessor(String)`
- `uninstall()`
- `uninstallForced()`

*Returns* true if the deployment package is stale. false otherwise

*See Also* `uninstall()`, `uninstallForced()`

#### 114.14.6.18 **public void uninstall() throws DeploymentException**

- Uninstalls the deployment package. After uninstallation, the deployment package object becomes stale. This can be checked by using `isStale()`, which will return true when stale.

*Throws* `DeploymentException`– if the deployment package could not be successfully uninstalled. For detailed error code description see `DeploymentException`.

`SecurityException`– if the caller doesn't have the appropriate `DeploymentAdminPermission("<filter>", "uninstall")` permission.

`IllegalStateException`– if the package is stale

#### 114.14.6.19 **public boolean uninstallForced() throws DeploymentException**

- This method is called to completely uninstall a deployment package, which couldn't be uninstalled using traditional means (`uninstall()`) due to exceptions. After uninstallation, the deployment package object becomes stale. This can be checked by using `isStale()`, which will return true when stale.

The method forces removal of the Deployment Package from the repository maintained by the Deployment Admin service. This method follows the same steps as `uninstall()`. However, any errors or the absence of Resource Processor services are ignored, they must not cause a roll back. These errors should be logged.

*Returns* true if the operation was successful

*Throws* `DeploymentException`– only `DeploymentException.CODE_TIMEOUT` and `DeploymentException.CODE_CANCELLED` can be thrown. For detailed error code description see `DeploymentException`.

`SecurityException`– if the caller doesn't have the appropriate `DeploymentAdminPermission("<filter>", "uninstall_forced")` permission.

`IllegalStateException`– if the package is stale

## 114.15 **org.osgi.service.deploymentadmin.spi**

Deployment Admin SPI Package Version 1.0. The SPI is used by Resource Processors.

Bundles wishing to use this package must list the package in the Import-Package header of the bundle's manifest. This package has two types of users: the consumers that use the API in this package and the providers that implement the API in this package.

Example import for consumers using the API in this package:

```
Import-Package: org.osgi.service.deploymentadmin.spi; version="[1.0,2.0)"
```

Example import for providers implementing the API in this package:

```
Import-Package: org.osgi.service.deploymentadmin.spi; version="[1.0,1.1)"
```

**114.15.1 Summary**

- `DeploymentCustomizerPermission` - The `DeploymentCustomizerPermission` permission gives the right to Resource Processors to access a bundle's (residing in a Deployment Package) private area.
- `DeploymentSession` - The session interface represents a currently running deployment session (install/update/uninstall).
- `ResourceProcessor` - `ResourceProcessor` interface is implemented by processors handling resource files in deployment packages.
- `ResourceProcessorException` - Checked exception received when something fails during a call to a Resource Processor.

**114.15.2 public class DeploymentCustomizerPermission extends Permission**

The `DeploymentCustomizerPermission` permission gives the right to Resource Processors to access a bundle's (residing in a Deployment Package) private area. The bundle and the Resource Processor (customizer) have to be in the same Deployment Package.

The Resource Processor that has this permission is allowed to access the bundle's private area by calling the `DeploymentSession.getDataFile(Bundle)` method during the session (see `DeploymentSession`). After the session ends the `FilePermissions` are withdrawn. The Resource Processor will have `FilePermission` with "read", "write" and "delete" actions for the returned `java.io.File` that represents the base directory of the persistent storage area and for its subdirectories.

The actions string is converted to lowercase before processing.

**114.15.2.1 public static final String PRIVATEAREA = "privatearea"**

Constant String to the "privatearea" action.

**114.15.2.2 public DeploymentCustomizerPermission(String name,String actions)**

*name* Bundle Symbolic Name of the target bundle, must not be null.

*actions* action string (only the "privatearea" or "\*" action is valid; "\*" means all the possible actions), must not be null.

- Creates a new `DeploymentCustomizerPermission` object for the given name and action.

The name parameter is a filter string. This filter has the same syntax as an OSGi filter but only the "name" attribute is allowed. The value of the attribute is a Bundle Symbolic Name that represents a bundle. The only allowed action is the "privatearea" action. E.g.

```
Permission perm = new DeploymentCustomizerPermission(
    "(name=com.acme.bundle)", "privatearea");
```

The Resource Processor that has this permission is allowed to access the bundle's private area by calling the `DeploymentSession.getDataFile(Bundle)` method. The Resource Processor will have `FilePermission` with "read", "write" and "delete" actions for the returned `java.io.File` and its subdirectories during the deployment session.

*Throws* `IllegalArgumentException`— if the filter is invalid, the list of actions contains unknown operations or one of the parameters is null

**114.15.2.3 public boolean equals(Object obj)**

*obj* the reference object with which to compare.

- Checks two `DeploymentCustomizerPermission` objects for equality. Two permission objects are equal if:

- their target filters are equal (semantically and not character by character) and
- their actions are the same

*Returns* true if the two objects are equal.

*See Also* java.lang.Object.equals(java.lang.Object)

#### 114.15.2.4 **public String getActions()**

- Returns the String representation of the action list.

*Returns* Action list of this permission instance. It is always "privatearea".

*See Also* java.security.Permission.getActions()

#### 114.15.2.5 **public int hashCode()**

- Returns hash code for this permission object.

*Returns* Hash code for this permission object.

*See Also* java.lang.Object.hashCode()

#### 114.15.2.6 **public boolean implies(Permission permission)**

*permission* Permission to check.

- Checks if this DeploymentCustomizerPermission would imply the parameter permission. This permission implies another DeploymentCustomizerPermission permission if:
  - both of them has the "privatearea" action (other actions are not allowed) and
  - their filters (only name attribute is allowed in the filters) match similarly to DeploymentAdmin-Permission.

The value of the name attribute means Bundle Symbolic Name and not Deployment Package Symbolic Name here!

*Returns* true if this DeploymentCustomizerPermission object implies the specified permission.

*See Also* java.security.Permission.implies(java.security.Permission)

#### 114.15.2.7 **public PermissionCollection newPermissionCollection()**

- Returns a new PermissionCollection object for storing DeploymentCustomizerPermission objects.

*Returns* The new PermissionCollection.

*See Also* java.security.Permission.newPermissionCollection()

### 114.15.3 **public interface DeploymentSession**

The session interface represents a currently running deployment session (install/update/uninstall).

When a deployment package is installed the target package, when uninstalled the source package is an empty deployment package. The empty deployment package is a virtual entity it doesn't appear for the outside world. It is only visible on the DeploymentSession interface used by Resource Processors. Although the empty package is only visible for Resource Processors it has the following characteristics:

- has version 0.0.0
- its name is an empty string
- it is stale

- it has no bundles (see `DeploymentPackage.getBundle(String)`)
- it has no resources (see `DeploymentPackage.getResources()`)
- it has no headers except
  - `DeploymentPackage-SymbolicName` and
  - `DeploymentPackage-Version`
 (see `DeploymentPackage.getHeader(String)`)
- it has no resource headers (see `DeploymentPackage.getResourceHeader(String, String)`)
- `DeploymentPackage.uninstall()` throws `java.lang.IllegalStateException`
- `DeploymentPackage.uninstallForced()` throws `java.lang.IllegalStateException`

#### 114.15.3.1 **public File getDataFile(Bundle bundle)**

*bundle* the bundle the private area belongs to

- Returns the private data area of the specified bundle. The bundle must be part of either the source or the target deployment packages. The permission set the caller resource processor needs to manipulate the private area of the bundle is set by the Deployment Admin on the fly when this method is called. The permissions remain available during the deployment action only.

The bundle and the caller Resource Processor have to be in the same Deployment Package.

*Returns* file representing the private area of the bundle. It cannot be null.

*Throws* `SecurityException`— if the caller doesn't have the appropriate `DeploymentCustomizerPermission("<filter>", "privatearea")` permission.

*See Also* `DeploymentPackage`, `DeploymentCustomizerPermission`

#### 114.15.3.2 **public DeploymentPackage getSourceDeploymentPackage()**

- If the deployment action is an install or an update, this call returns the `DeploymentPackage` instance that corresponds to the deployment package being streamed in for this session. If the deployment action is an uninstall, this call returns the empty deployment package (see `DeploymentPackage`).

*Returns* the source deployment package

*See Also* `DeploymentPackage`

#### 114.15.3.3 **public DeploymentPackage getTargetDeploymentPackage()**

- If the deployment action is an update or an uninstall, this call returns the `DeploymentPackage` instance for the installed deployment package. If the deployment action is an install, this call returns the empty deployment package (see `DeploymentPackage`).

*Returns* the target deployment package

*See Also* `DeploymentPackage`

### 114.15.4 **public interface ResourceProcessor**

`ResourceProcessor` interface is implemented by processors handling resource files in deployment packages. Resource Processors expose their services as standard OSGi services. Bundles exporting the service may arrive in the deployment package (customizers) or may be preregistered (they are installed previously). Resource processors has to define the `service.pid` standard OSGi service property which should be a unique string.

The order of the method calls on a particular Resource Processor in case of install/update session is the following:

1. `begin(DeploymentSession)`

2. `process(String, InputStream)` calls till there are resources to process or `rollback()` and the further steps are ignored
3. `dropped(String)` calls till there are resources to drop
4. `prepare()`
5. `commit()` or `rollback()`

The order of the method calls on a particular Resource Processor in case of uninstall session is the following:

1. `begin(DeploymentSession)`
2. `dropAllResources()` or `rollback()` and the further steps are ignored
3. `prepare()`
4. `commit()` or `rollback()`

#### 114.15.4.1 **public void begin(DeploymentSession session)**

*session* object that represents the current session to the resource processor

- Called when the Deployment Admin starts a new operation on the given deployment package, and the resource processor is associated a resource within the package. Only one deployment package can be processed at a time.

*See Also* `DeploymentSession`

#### 114.15.4.2 **public void cancel()**

- Processing of a resource passed to the resource processor may take long. The `cancel()` method notifies the resource processor that it should interrupt the processing of the current resource. This method is called by the `DeploymentAdmin` implementation after the `DeploymentAdmin.cancel()` method is called.

#### 114.15.4.3 **public void commit()**

- Called when the processing of the current deployment package is finished. This method is called if the processing of the current deployment package was successful, and the changes must be made permanent.

#### 114.15.4.4 **public void dropAllResources() throws ResourceProcessorException**

- This method is called during an "uninstall" deployment session. This method will be called on all resource processors that are associated with resources in the deployment package being uninstalled. This provides an opportunity for the processor to cleanup any memory and persistent data being maintained for the deployment package.

*Throws* `ResourceProcessorException`– if all resources could not be dropped. Only the `ResourceProcessorException.CODE_OTHER_ERROR` is allowed.

#### 114.15.4.5 **public void dropped(String resource) throws ResourceProcessorException**

*resource* the name of the resource to drop (it is the same as the value of the "Name" attribute in the deployment package's manifest)

- Called when a resource, associated with a particular resource processor, had belonged to an earlier version of a deployment package but is not present in the current version of the deployment package. This provides an opportunity for the processor to cleanup any memory and persistent data being maintained for the particular resource. This method will only be called during "update" deployment sessions.

*Throws* `ResourceProcessorException`– if the resource is not allowed to be dropped. Only the `ResourceProcessorException.CODE_OTHER_ERROR` error code is allowed

**114.15.4.6 public void prepare() throws ResourceProcessorException**

- This method is called on the Resource Processor immediately before calling the commit method. The Resource Processor has to check whether it is able to commit the operations since the last begin method call. If it determines that it is not able to commit the changes, it has to raise a ResourceProcessorException with the ResourceProcessorException.CODE\_PREPARE error code.

*Throws* ResourceProcessorException– if the resource processor is able to determine it is not able to commit. Only the ResourceProcessorException.CODE\_PREPARE error code is allowed.

**114.15.4.7 public void process(String name,InputStream stream) throws ResourceProcessorException**

*name* The name of the resource relative to the deployment package root directory.

*stream* The stream for the resource.

- Called when a resource is encountered in the deployment package for which this resource processor has been selected to handle the processing of that resource.

*Throws* ResourceProcessorException– if the resource cannot be processed. Only ResourceProcessorException.CODE\_RESOURCE\_SHARING\_VIOLATION and ResourceProcessorException.CODE\_OTHER\_ERROR error codes are allowed.

**114.15.4.8 public void rollback()**

- Called when the processing of the current deployment package is finished. This method is called if the processing of the current deployment package was unsuccessful, and the changes made during the processing of the deployment package should be removed.

**114.15.5 public class ResourceProcessorException extends Exception**

Checked exception received when something fails during a call to a Resource Processor. A ResourceProcessorException always contains an error code (one of the constants specified in this class), and may optionally contain the textual description of the error condition and a nested cause exception.

**114.15.5.1 public static final int CODE\_OTHER\_ERROR = 463**

Other error condition.

All Resource Processor methods which throw ResourceProcessorException is allowed throw an exception with this error code if the error condition cannot be categorized.

**114.15.5.2 public static final int CODE\_PREPARE = 1**

Resource Processors are allowed to raise an exception with this error code to indicate that the processor is not able to commit the operations it made since the last call of ResourceProcessor.begin(DeploymentSession) method.

Only the ResourceProcessor.prepare() method is allowed to throw exception with this error code.

**114.15.5.3 public static final int CODE\_RESOURCE\_SHARING\_VIOLATION = 461**

An artifact of any resource already exists.

Only the ResourceProcessor.process(String, InputStream) method is allowed to throw exception with this error code.

**114.15.5.4 public ResourceProcessorException(int code,String message,Throwable cause)**

*code* The error code of the failure. Code should be one of the predefined integer values (CODE\_X).

*message* Message associated with the exception

*cause* the originating exception



- Create an instance of the exception.

**114.15.5.5      public ResourceProcessorException(int code,String message)**

*code* The error code of the failure. Code should be one of the predefined integer values (CODE\_X).

*message* Message associated with the exception

- Create an instance of the exception. Cause exception is implicitly set to null.

**114.15.5.6      public ResourceProcessorException(int code)**

*code* The error code of the failure. Code should be one of the predefined integer values (CODE\_X).

- Create an instance of the exception. Cause exception and message are implicitly set to null.

**114.15.5.7      public Throwable getCause()**

- Returns the cause of this exception or null if no cause was set.

*Returns* The cause of this exception or null if no cause was set.

**114.15.5.8      public int getCode()**

*Returns* Returns the code.

**114.15.5.9      public Throwable initCause(Throwable cause)**

*cause* The cause of this exception.

- Initializes the cause of this exception to the specified value.

*Returns* This exception.

*Throws* IllegalArgumentException– If the specified cause is this exception.

IllegalStateException– If the cause of this exception has already been set.

*Since* 1.0.1

## 114.16      References

- [1] *JAR File Specification*  
<http://download.oracle.com/javase/1.4.2/docs/guide/jar/jar.html>
- [2] *OSGi Core Release 6*  
<http://www.osgi.org/Specifications/HomePage>



# 115 Auto Configuration Specification

## Version 1.0

### 115.1 Introduction

The purpose of the Auto Configuration specification is to allow the configuration of bundles. These bundles can be embedded in Deployment Packages or bundles that are already present on the OSGi Framework. This specification defines the format and processing rules of a Autoconf Resource Processor. Resource processors are defined in *Deployment Admin Specification* on page 389.

An Auto Configuration Resource contains information to define Configuration objects for the *Configuration Admin Service Specification* on page 87.

#### 115.1.1 Entities

- *AutoconfResource* - One or more resources in a Deployment Package that are processed by the Autoconf Processor.
- *Deployment Package* - A named and versioned file that groups resources into a single management unit. Deployment packages are the unit of deployment and uninstallation. Deployment packages can contain bundles and associated deployment-time resources that are processed by Resource Processors.
- *Resource Processor* - A deployment-time customizer that accepts a resource in a Deployment Package and turns it into a number of artifacts. A resource processor is a service that implements the ResourceProcessor interface.
- *AutoconfResource Processor* - The Resource Processor that processes the autoconf resources in a Deployment Package.

Figure 115.1 Autoconf Context Diagram

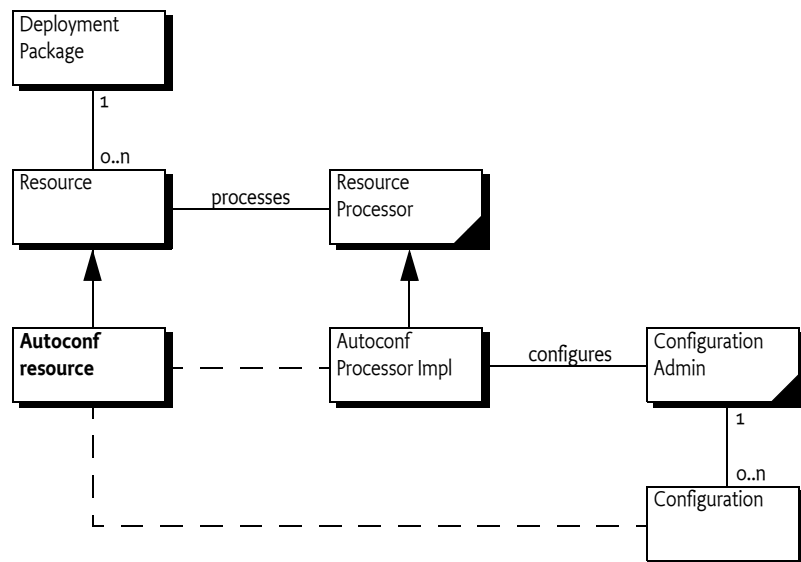

### 115.1.2 Synopsis

A Deployment Package can contain one or more Autoconf resources. The Manifest of the Deployment Package connects this resource to the Autoconf Resource Processor. When the Deployment Package is deployed, the Autoconf Resource Processor reads the information from the Autoconf resources and creates Configuration objects: both Managed Service as well as Managed Service Factory Configuration objects.

When the Deployment Package is updated or uninstalled, the Autoconf Resource Processor must delete the appropriate Configuration objects.

## 115.2 Configuration Data

Bundles usually require configuration data when they are deployed. For example, a bundle that has to contact a central server needs one or more server URLs. In practice, a complete application can consist of:

- A number of bundles
- Their configuration data
- Other required resources

The Deployment Package allows such an application to be installed, updated, and uninstalled in a single operation. This specification extends the Deployment Package with a facility to create Configuration objects. The extension uses the Resource Processor mechanism to read one or more resources from the Deployment Package and create Configuration objects based on these resources.

For example, a Deployment Package contains a single bundle Chat. This bundle, when started, registers a Managed Service with a PID of `com.acme.pid.Chat`. The expected Configuration Dictionary contains a single property: `serverurl`.

The schema explanation for an Autoconf resource can be found in *Metatype Service Specification* on page 131. An Autoconf resource could look like:

```
<?xml version="1.0" encoding="UTF-8"?>
<metatype:MetaData
  xmlns:metatype=
    "http://www.osgi.org/xmlns/metatype/v1.1.0">

  <OCD id="ChatConfiguration">
    <AD id="server" type="String">
  </OCD>

  <Designate pid="com.acme.pid.Chat"
    bundle="http://www.acme.com/chat.jar">
    <Object ocdref="ChatConfiguration">
      <Attribute adref="server" name="serverurl"
        content="http://chat.acme.com"/>
    </Object>
  </Designate>

</metatype:MetaData>
```

The OCD element (an abbreviation of Object Class Definition) defines the type of the Configuration Dictionary. This typing is based on the *Metatype Service Specification* on page 131. The Designate element links the configuration data to a PID. This PID is the PID for the configuration object. The con-

tent is defined in an Object element. An Object element links to an OCD element and defines the values of the attributes in Attribute elements.

The Autoconf Resource Processor in the example is instructed by this resource to create a Managed Service Configuration object with a Dictionary object that contains `serverurl="http://chat.acme.com"`.

An Autoconf resource can configure Managed Service configurations, as long as the bundle is contained in the same Deployment Package. For bundles that are not contained in the Deployment Package, a.k.a. *foreign bundles*, only Managed Service Factory configurations can be created. Configuring foreign bundles with a Managed Service configuration could create ownership conflicts and is therefore explicitly not allowed.

The Autoconf Resource Processor must be able to handle installations, updates, and uninstalls of Deployment Packages.

## 115.3 Processing

The Autoconf Resource Processor must register itself with the following PID to become available to the Deployment Admin service:

```
org.osgi.deployment.rp.autoconf
```

The Autoconf Resource Processor must process each Designate element in order of appearance. This element has the following information:

- *pid* - The PID of the Configuration object. If the Configuration object is a factory configuration, the PID is actually an alias of the actual PID because a factory configuration PID is generated.
- *factoryPid* - (String) Defines a factory PID when this Designate is a *factory configuration*; otherwise it is for a *singleton configuration*.
- *bundle* - The location of the bundle. It must be used to set the location of the Configuration object. This attribute is mandatory for autoconf though it is not mandatory for the schema because other applications might not need a bundle location.
- *merge* - (true|false) Indicates that the value of the contained Object definition replaces (merge=false) the configuration data, or only replaces properties (merge=true) that do not exist in the configuration data.
- *optional* - (true|false) If true, then this Designate element is optional, and errors during processing must be ignored. Otherwise, errors during processing must abort the installation of the Deployment Package. This requires the undoing of any work done so far.

The content of a Designate element is an Object element. This element contains the value for the configuration Dictionary.

If the Designate element was marked optional, then any errors during these steps can be ignored and the next Designate element must be processed.

A factory configuration is processed differently from a singleton configuration. These two different processing methods are discussed in the following sections.

### 115.3.1 Factory Configurations

Factory configurations can be created and deleted any number of times. This concept of multiplicity makes it straightforward to associate factory configurations with a Deployment Package. Each Deployment Package can create its unique configurations that are independent of any other Deployment Packages. When the Deployment Package is uninstalled, the created configurations can be deleted without any concern for sharing.

A factory configuration is defined in a Designate element. The factoryPid must be set to the PID of the related Managed Service Factory service. For example:

```
<Designate pid="a" factoryPid="com.acme.a"
           bundle="osgi-dp:com.acme.A">
  <Object ocdref="a">
    <Attribute adref="foo" content="Zaphod Beeblebrox"/>
  </Object>
</Designate>
```

The Autoconf resource cannot use the actual PID of the Configuration object because the Configuration Admin service automatically generates the PID of factory configurations. This created PID is called the *actual* PID.

The Autoconf resource author cannot know the actual PID ahead of time. The Autoconf resource must therefore specify a *alias*. The alias does not have to be globally unique; it must only be unique for a specific Autoconf resource. The Autoconf Processor must maintain the following association (per Autoconf resource):

alias → actual PID

The alias can be viewed as an Autoconf resource local name for the factory configuration PID. The actual PID is generated when the Autoconf processor creates a new factory configuration. This mapping is identical to the mapping defined for the Configuration Admin Plugin.

The alias → actual PID association must be used by the Autoconf Processor to decide what life cycle operation to execute.

- *Alias* →  $\emptyset$  - This installation is a first-time installation of the factory configuration. The Autoconf resource specifies a factory configuration that was not part of a previous installation. The Autoconf Processor must therefore create a new factory configuration, set the configuration dictionary to the values in the Object element (see *Assigning a Value* on page 444 ), and create the Alias → Actual association.
- *Alias* → *Actual* - The factory configuration already exists from a previous Autoconf resource installation. The Autoconf Processor must merge or override (depending on the merge attribute) the Configuration object designated by the actual PID with the values in the Object element (see *Assigning a Value* on page 444 ).
- $\emptyset$  → *Actual* - The Autoconf resource no longer contains an alias that it previously contained. The configuration identified by the actual PID must be deleted.

Uninstalling an Autoconf resource requires that the Autoconf Resource Processor deletes all Configuration objects associated with the resource.

### 115.3.2 Singleton Configuration

A singleton configuration is associated with a Managed Service. The Autoconf Resource Processor must only use singleton configurations for bundles that are contained in the same Deployment Package as the Autoconf resource. The target Deployment Package can provide a list of these bundles.

This ownership policy is required to prevent sharing conflicts. For this reason, the bundle attribute in the Designate element must be set to the location of the bundle so that this ownership is enforced by the Configuration Admin service. The location of the bundle is defined by the Bundle Symbolic Name of the given bundle prefixed with osgi-dp:.

The processing must abort with a fatal error if the bundle attribute is not set. The Autoconf Resource processor must bind the singleton configuration to the given bundle.

If a singleton configuration with a given PID already exists, it must be unbound or bound to the same location contained by the bundle attribute. Otherwise the processing must abort.

The singleton configuration must be merged with or replaced by the information in the Object element, depending on the merge attribute as described in *Assigning a Value* on page 444.

### 115.3.3 Example

For example, bundle A uses a factory configuration with the factory PID `com.acme.a` and bundle B uses a singleton configuration with PID `com.acme.b`. They define the following configuration properties:

```
com.acme.a:
gear          Integer
ratio         Vector of Float
```

```
com.acme.b:
foo           String
bar           Short[]
```

For proper operation, a Deployment Package P needs a configuration for `com.acme.a` and `com.acme.b` with the following values:

```
gear          = 3
ratio         = {3.14159, 1.41421356, 6.022E23}
foo           = "Zaphod Beeblebrox"
bar           = {1,2,3,4,5}
```

The corresponding `autoconf.xml` resource associated with Deployment Package P would look like:

```
<?xml version="1.0" encoding="UTF-8"?>
<metatype:MetaData
  xmlns:metatype=
    "http://www.osgi.org/xmlns/metatype/v1.1.0">

  <OCD id="a">
    <AD id="gear" type="Integer" cardinality="0" />
    <AD id="ratio" type="Float" cardinality="-3" />
  </OCD>

  <OCD id="b">
    <AD id="foo" type="String" cardinality="0"/>
    <AD id="bar" type="Short" cardinality="5"/>
  </OCD>

  <Designate pid="x" factoryPid="com.acme.a"
    bundle="osgi-dp:com.acme.a">
    <Object ocdref="a">
      <Attribute adref="gear" content="3" />
      <Attribute adref="ratio">
        <Value>3.14159</Value>
        <Value>1.41421356</Value>
        <Value>6.022E23</Value>
      </Attribute>
    </Object>
  </Designate>

  <Designate pid="com.acme.b"
    bundle="osgi-dp:com.acme.B">
    <Object ocdref="b">
```

```
<Attribute adref="foo" content="Zaphod Beeblebrox" />
<Attribute adref="bar" >
  <Value>1</Value>
  <Value>2</Value>
  <Value>3</Value>
  <Value>4</Value>
  <Value>5</Value>
</Attribute>
</Object>
</Designate>
</metatype:MetaData>
```

### 115.3.4 Assigning a Value

The Autoconf resources share a scheme and can cooperate with the *Metatype Service Specification* on page 131. An Autoconf resource primarily contains a number of values for configuration objects in the Designate elements. Designate elements:

- Are for a factory or singleton configuration (factoryPid attribute)
- Are bound to a bundle location (bundle attribute)
- Are meant to be merged with an existing value or replace an existing value (merge attribute). Merging means only setting the values for which the existing Configuration object has no value.
- Provide a value for the Configuration object with the Object element.

Designate elements contain an Object element that contains the actual value. Object elements refer to an OCD element by name. The OCD elements act as a descriptor of the properties.

The OCD elements that are referred from an Object element can be contained in the Autoconf resource, or they can come from the Meta Type service. The reference takes place through the ocdref attribute of the Object element. The Autoconf Resource Processor must first match this name to any OCD elements in the Autoconf resources. If the reference cannot be found in this file, it must consult the Meta Type service (if present) for the bundle that is associated with the PID that is configured.

### 115.3.5 Process Ordering

The Autoconf Processor must create any factory and singleton configurations when it is called with an Autoconf resource. This phase should perform as much validation as possible. The configurations must be created in the order of appearance in the Autoconf resource.

In the commit method, the Autoconf Resource Processor must first delete all Configuration objects that were uninstalled. Thereafter, it must set or update the appropriate Configuration objects.

This ordering implies that a customizer bundle cannot receive configuration parameters from an Autoconf resource.

## 115.4 Security Considerations

Allowing a deployment package's Autoconf resources to (re)configure arbitrary configurations creates security threats. The possible threats are discussed in the following sections.

### 115.4.1 Location Binding

As described in *Configuration Admin Service Specification* on page 87, it is possible for a malicious bundle to register a Managed Service under a PID used by another (legitimate) bundle. This activity essentially *hijacks* the Managed Service PID, and constitutes a denial of service attack on the legitimate



bundle (as it never receives the configuration information it needs). The Configuration Admin specification describes a location binding technique that can be used to prevent this attack. The Autoconf Resource Processor must bind Configuration objects to locations specified in the Autoconf resources using the mandatory bundle attribute.

#### 115.4.2

### Autoconf Resource Permissions

The capabilities of an Autoconf Resource Processor must be limited to the permissions that are granted to the signer of a Deployment Package. This is the specified way for the Deployment Admin service to act. The Autoconf Resource Processor does not have to take any special actions; all its actions are automatically scoped by the signer of the Deployment Package.

This restriction implies, however, that the Autoconf Resource Processor must do a `doPrivileged` method for any actions that should not be scoped: for example, when it persists the associations of the alias → actual PID.

A Deployment Package that requires any activity from the Autoconf Resource processor must at least provide `ConfigurationPermission[*],CONFIGURE]`.



# 116 Application Admin Specification

## Version 1.1

### 116.1 Introduction

The OSGi Application Admin specification is intended to simplify the management of an environment with many different *types* of applications that are simultaneously available. A diverse set of application types are a fact of life because backward compatibility and normal evolution require modern devices to be able to support novel as well as legacy applications. End users do not care if an application is an Applet, a Midlet, a bundle, a Symbian, or a BREW application. This specification enables applications that manage other applications, regardless of application type. These applications are called *application managers*. This specification supports enumerating, launching, stopping and locking applications. This specification does not specify a user interface or end-user interactions.

The OSGi Framework is an excellent platform on which to host different Application Containers. The class loading and code sharing mechanisms available in the OSGi Framework can be used to implement powerful and extendable containers for Java based application models with relative ease. Native code based application models like Symbian and BREW can be supported with proxies.

#### 116.1.1 Essentials

- *Generic Model* - The Application Admin specification defines how all applications, regardless of type, can be launched and destroyed. This application-type neutral model allows a screen or desktop manager access to all executable content in a uniform manner.
- *Schedule* - A mechanism that allows the launching of applications at a predefined time, interval, or event.
- *Dynamic* - Detects installations and uninstallations of applications in real time.
- *Locking* - Allows applications to be persistently locked so that they cannot be launched.
- *Exit Value* - Provide a return value for an application that has exited.

#### 116.1.2 Entities

- *Application* - A software component, which has well-defined entry and exit criteria. Applications can be started and destroyed, and usually are designed for user interaction. Applications may be of various types, each having their own specification. Applications and application instances are visible through the their Application Descriptor services and Application Handle services.
- *Application Container* - An implementation of a runtime environment for one or more application types. It provides specialized Application Descriptor and Application Handle services that correspond to the supported application type and their instances. The design of a particular Application Container is defined by other specifications. For example, an Application Container which implements MIDlets must follow the appropriate JSR specifications for MIDP.
- *Application Handle* - A service that represents an *instance* of an application. This service is available in the OSGi service registry as long as the application instance exists.
- *Application Instance* - The actual application that has been launched. Registered in the service registry as long as the application is running.

- *Application Descriptor* - A service that represents an installed Application and provides information about the application as well as launching, scheduling and locking features. An Application Descriptor must be registered for each application as long as the Application is installed
- *Application Manager* - A bundle that manages a number of applications.
- *Scheduled Application* - An information record for a scheduled application.

Figure 116.1

Application Management Diagram *org.osgi.service.application* package

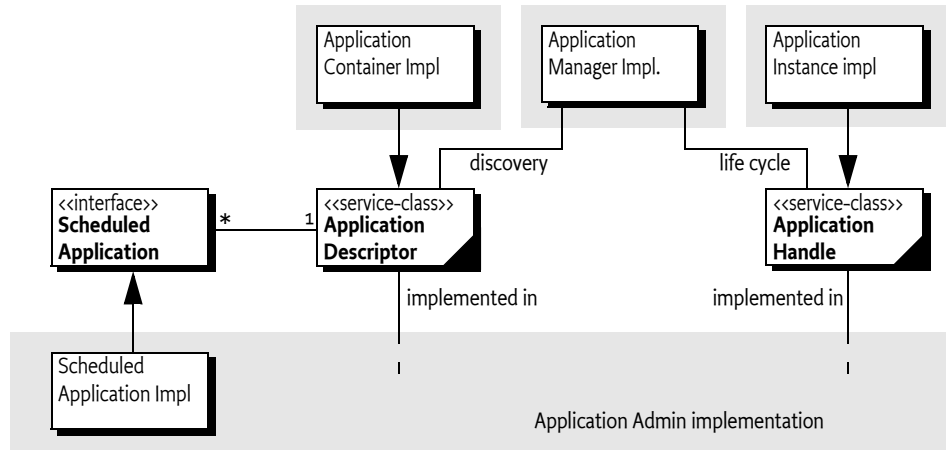

### 116.1.3

## Synopsis

Different types of applications can be accommodated in the Application Admin specification using a model of Application Containers. An Application Container typically follows an external specification, for example, the MIDP specification. In an OSGi environment, the implementer of such a specification can allow its applications (MIDlets in the previous example) to participate in the OSGi Application Model by registering an Application Descriptor service for each of its installed applications, and an Application Handle service for each of its running instances.

This model leverages the capabilities of the OSGi service registry. Installed applications and running applications can be found by enumerating the appropriate services, possibly using a filter if a specific application is sought. The service registry provides necessary isolation of the clients of the applications and their implementers. Typical clients of this specification are desktop/screen managers that provide the end user access to the installed applications.

## 116.2 Application Managers

An application manager (a bundle or application that manages other applications) must be able to discover the available applications, present them to an end user and launch applications on demand. A bundle that maintains the display of a mobile phone is a typical client of this specification.

### 116.2.1

## Discovery

The primary means of discovery is the Application Descriptor service. An Application Container must register an Application Descriptor service for each of its applications. An application manager can detect the installation and uninstallation of applications by listening to service events.

Service properties on the Application Descriptor carry most of the information that an application manager requires to present the application to the end user. The properties as defined in the following table.

Table 116.1 *Service Properties for an Application Descriptor*

Key Name	Type	Default	Description
service.pid	String	<i>must be set</i>	Unique identifier of the application. It is recommended to set a value generated from the vendor's reverse domain name, e.g. com.acme.application.chess. The service.pid service property is a standard Framework property.
application.version	String	<i>empty string</i>	Specifies the version of the application. The default value is an empty string
service.vendor	String	<i>empty string</i>	Specifies the vendor of the application.
application.container	String	<i>must be set</i>	A unique identifier (like a PID) of the container implementation that registered this application descriptor.
application.location	String	<i>must be set</i>	The identifier of package that contains the application corresponding to this descriptor. It represents the installation unit that contains the corresponding application. It should be a URL. For applications installed as bundles, it should be the location of the bundle. For others, it is defined by the container implementation.
application.visible	Boolean	true	Specifies whether the application should be visible for the user. For example, some applications may provide features to other applications but nothing directly to the user. In this case the application should not be revealed to the user to start it individually.
application.launchable	Boolean	false	Specifies whether the application is ready to be launched. If the value is true, it means that all the requirements of the application are fulfilled.
application.locked	Boolean	false	Specifies whether the represented application is locked to prevent launching it.

Specialized application descriptors can offer further service properties and method. For example, a MIDP container can register a property that describes that the MIDlet comes from a specific JAD file, thereby allowing a MIDlet aware Application Manager to group these MIDlets.

Application Descriptor services must not be declarative. That is, they can be obtained from the service registry at any time without accidentally initializing a class loader.

The following example shows how to track all visible, launchable, and unlocked applications. These tracked applications are the ones that can be started.

```
public class TrackLaunchables {
    final static String filter=
        "&(objectclass="
        + ApplicationDescriptor.class.getName()
        + ") (application.launchable=true) "
        + "(application.visible=true) "
        + "(application.locked=false)";
    static ApplicationDescriptor[] EMPTY =
        new ApplicationDescriptor[0];
}
```

```

    ServiceTracker tracker;

    public void init(BundleContext cntxt) throws Exception {
        tracker = new ServiceTracker(cntxt,
            cntxt.createFilter(filter), null);
        tracker.open();
    }

    public ApplicationDescriptor[] getActive() {
        Object [] result = tracker.getServices();
        List list = Arrays.asList(result);
        return (ApplicationDescriptor []) list.toArray(EMPTY);
    }
}

```

The code is quite simple because the Service Tracker does the actual tracking. The most important part is therefore the filter. The filter selects all the Application Descriptor services that are visible, launchable, and not locked. The `getActive` method converts the `Object[]` that the Service Tracker maintains into an array of Application Descriptors.

### 116.2.2 Application Descriptor Properties

The Application Descriptor object has an additional number of properties that are not available as service properties. These descriptor properties can be localized. The `getProperties(String)` method therefore takes a *locale* String object. This is a standard locale string as defined by the `java.util.Locale` class. The order for the locale constituents is:

- language
- country
- variant

For example, the following files provide manifest translations for English, Dutch (Belgium and the Netherlands) and Swedish.

```

en            n1_BE
n1_NL        sv

```

It returns a Map object containing localized versions of the properties. This is a copy of the original objects so changes to this Map object are not reflected in the Application Descriptor properties.

If the locale string is null, the localization will be based on the default locale, as specified by the `java.util.Locale.getDefault` method. If the locale is the empty String object (""), no localization must be used. This will contain the raw values that are usually used as keys. If a specific locale has no appropriate translations, a less specific locale must be used, as described in the Locale class. As last resort, the raw values must be returned.

The key names in the Map object are case-sensitive. Application Containers can add additional properties to this Map object, however, they must avoid key names starting with `application`. They should use key names that have a prefix that does not collide with other Application Containers.

If no locale specific value of an application property is available then the default one must be returned. The following case-sensitive key names are treated as standard for locale specific values in the Map object. Additional elements may also be stored in the Map object. The specified properties are explained in the following table.

Table 116.2 *Descriptor localized properties*

Key Name	Type	Default	Description
<code>application.name</code>	String	<i>must be set</i>	The name of the application.

Key Name	Type	Default	Description
application.icon	URL	<i>No Icon</i>	A URL an icon's image resource. A compliant implementation of this specification must support the [1] <i>PNG Image Format</i> .
application.version	String	o.o.o	The version of the application
service.vendor	String		The vendor of the application
application.visible	Boolean	true	
application.launchable	Boolean	true	If the application can be launched
application.locked	Boolean	true	If the application is locked
application.description	String		A description of the application
application.documentation	String		Document
application.copyright	String		A Copyright statement
application.license	String		A URL to the license related to the application
application.container	String	<i>must be set</i>	The PID of the associated container
application.location	String		The URL of the location of the corresponding JAR file of the application, if exists.

### 116.2.3 Launching

The Application Descriptor provides the `launch(Map)` methods for application managers to launch an application. Launching consists of creating the specific application object, starting it, registering an Application Handle service that represents that instance and return the Application Handle service.

The Map object parameter is application specific. Applications should use unique names for the keys in this map, for example `com.acme.ringsignal`. This specification does not specify any keys for this map except for:

- `org.osgi.triggeringevent` - This property is set to the Event object that cause the application to be launched (if any).

When an application is started successfully the corresponding Application Handle service will be registered with the service registry.

### 116.2.4 Application States

An Application Handle service represents an instance of an application. The application handle is registered by the Application Container after successfully launching a new application instance.

An Application Handle service can be used to query the state and manipulate the application instance. It is the responsibility of the Application Handle service to maintain the application instance life cycle state by interacting with the implementation object of the application.

A running instance can have the following state according to this specification:

- **RUNNING** - This is the state of the Application Handle when it gets registered. It indicates that the application instance is active.
- **STOPPING** - The application is stopping. This is a transient state.

Application Containers can extend the number of states.

The Application Handle service maintains the service properties as listed in the following table. Specialized application handles may offer further service properties, but the key names specified in the table below must not be used for other purposes.

Table 116.3 Application Handle service properties

Key Name	Type	Default	Description
service.pid	String	<i>must be set</i>	The Application Instance ID as returned by the <code>getInstanceId</code> method.
application.state	String	<i>must be set</i>	Contains the current state of the application instance represented by this application handle. These states can be application model specific.
application.descriptor	String	<i>must be set</i>	The PID of the associated Application Descriptor service

Specialized application handles may offer further application states. The name of additional states must be qualified names (dotted); non-qualified names are reserved for future specifications.

### 116.2.5 Destroying an Application Instance

An application instance can be stopped with its associated Application Handle using the `destroy()` method. This first turns the state of the Application to `STOPPING`. The application instance may save its persistent data before termination and it must release all the used resources. The application instance's artifacts should not be reused any more. The Application Admin implementation and the application container should ensure (even forcefully) that all allocated resources are cleaned up.

If the application instance has completely stopped, then its Application Handle must be unregistered.

### 116.2.6 Getting the Exit Value of an Application

Many application containers allow an application to specify a value when the application is stopped. This value is called the *exit value*. The Application Handle can therefore return the exit value when this is supported by the underlying application model. It is possible to find out if the underlying container support exit values because not all application containers support exit values.

The Application Descriptor has a special service property that it must set when it supports exit values. This service property name is defined on the ApplicationHandle class as `APPLICATION_SUPPORTS_EXITVALUE`. Setting this property to any value signals that the application instance supports an exit value return.

The `getExitValue(long)` method on the ApplicationHandle class returns the exit value object from the underlying application container. If the application container does not support exit values, then this method must always throw an UnsupportedOperationException.

The method takes a time out value which allows it to wait for the application instance to finish. This time-out can take the following values:

- *negative* - When the time-out is negative, there is no waiting. If the application instance has finished, the exit value will be returned. Otherwise an Application Exception must be thrown with the error code set to `APPLICATION_EXITVALUE_NOT_AVAILABLE`.
- *zero* - The method will wait indefinitely until the application is finished.
- *positive* - The method will wait for the application to finish the given number of milliseconds. If after that time the application instance is still not finished, an Application Exception must be thrown with the error code set to `APPLICATION_EXITVALUE_NOT_AVAILABLE`.

The type of the exit value is undefined, it is a generic Java object. It is up to the application container to define the actual type for this Object.

### 116.2.7 Locking an Application

Applications represented by the application descriptors can be locked. If an application is locked then no new instance of the represented application can be started until it is unlocked. The locking



state of the application has no effect on the already launched instance(s). The Application Descriptor provides the methods `lock` and `unlock` to set, unset the locking state. Locking and unlocking an application represented by an Application Descriptor requires the proper Application Admin Permission. The methods to lock, unlock, and query the locked status of an application are implemented as final methods of the abstract application descriptor class to ensure that an application container implementation will not be able to circumvent this security policy.

## 116.2.8 Scheduling

Scheduling can be used to launch an a new application instance in the future when a specific event occurs, if needed on a recurring basis.

The Application Descriptor service provides the `schedule(String,Map,String,String,boolean)` method to schedule an application to be launched when an specific event occurs. The parameters to this method are:

- *Schedule Id* - (String) An id for this application that identifies the schedule, even over system restarts. Ids must be unique for one application. This id will be registered as service property on the Scheduled Application service under the name of `SCHEDULE_ID`. The name must match the following format:

```
scheduleId ::= symbolic-name
             // See General Syntax Definitions in Core
```

- *Arguments* - (Map) These arguments will be passed to the application in the launch method. The keys in this map must not be null or the empty string.
- *Topic* - (String) The topic of the event that must trigger the launch of the application.
- *Filter* - (String) A filter that is passed to the Event Admin for subscribing to specific events, can be null. The syntax of the string is the same as an OSGi Framework filter.
- *Recurring* - (boolean) Repeatedly launch the application when the specified events occur until the schedule is canceled.

The schedule method must register a Scheduled Application service with the service registry and return the Schedule Application service object.

For example, the invocation

```
appDesc.schedule(
    null,          // System generates schedule id
    null,         // No arguments
    "org/osgi/application/timer",
    "(&(hour_of_day=0) (minute=0))",
    true)
```

Schedules the application to be launched when a timer event is received and the `hour_of_day` and `minute` properties are zero.

The Scheduled Application service must have the following properties:

- `APPLICATION_PID` - (String) The PID of the Application Descriptor service.
- `SCHEDULE_ID` - (String) a unique id (within the schedules for one application).

The list of active Scheduled Application services can be obtained from the service registry. A non-recurrent Scheduled Application service is unregistered once the application is successfully launched.

The timer used to start an application from a schedule has a resolution of one minute. It is therefore possible that an application is delayed up to a minute before it is started.

### 116.2.9 Application Exceptions

Exceptional conditions that arise during processing of application requests. The Exception identifies the actual error with an integer code. The following codes are supported:

- [APPLICATION\\_INTERNAL\\_ERROR](#) - An internal error occurred.
- [APPLICATION\\_LOCKED](#) - The application is locked and can therefore not be launched.
- [APPLICATION\\_NOT\\_LAUNCHABLE](#) - The application could not be launched.
- [APPLICATION\\_SCHEDULING\\_FAILED](#) - The application scheduling could not be created due to some internal error. This entails that the scheduling information is not persisted.
- [APPLICATION\\_DUPLICATE\\_SCHEDULE\\_ID](#) - The application scheduling failed because the specified identifier is already in use.

### 116.2.10 Application Events

The event mechanism of the Application Admin specification is based on the OSGi service registry event model. Both Application Descriptor and Application Handle are services. Bundles can listen to these events registering a `ServiceListener` object with a Bundle Context or they can listen to events from the Event Admin, see for more information *Service Event* on page 375.

- Application Descriptor service
  - `REGISTERED` - A new application has become available. Depending on its properties, this application could be launched.
  - `MODIFIED` - The visibility, launchable or locked status is changed.
  - `UNREGISTERING` - The application is no longer available. All running instances of this application must be destroyed before this event is delivered.
- Application Handle service
  - `REGISTERED` - A new instance is created and started running.
  - `MODIFIED` - The application instance is changed its state. This specification only specifies the `STOPPING` state but application containers are free to add additional states. Transitions between all these states must be signaled with the `MODIFIED` service event.
  - `UNREGISTERING` - The application instance is no longer running.

## 116.3 Application Containers

Application Containers provide the implementation of a specific application model like MIDP, BREW, .NET, or Symbian. Application Containers can be implemented inside the OSGi environment or run externally, in another VM or as native code. When the container runs externally, it is necessary to run a proxy inside the OSGi environment that communicates with the external container. This is shown in Figure 116.2.

Figure 116.2 Application Container Model with Proxy

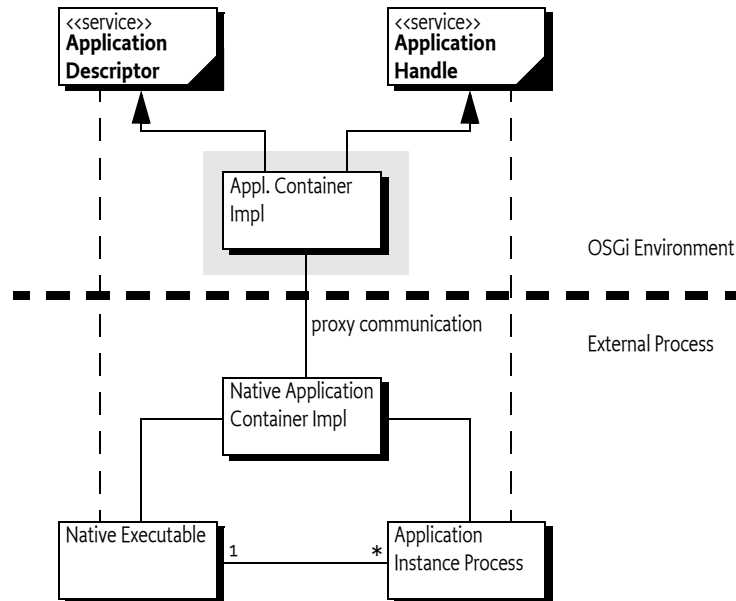

### 116.3.1 The Application Descriptor

The first responsibility of the Application Container is to register an Application Descriptor for each available application. The Application Container must therefore extend the ApplicationDescriptor base class that is provided by the Application Admin implementer and provided in the `org.osgi.service.application` package. The base class is defined as an abstract class in this specification with only minimal implementation code. Implementers of the Application Admin implementation can replace this class with an implementation that enforces their desired policies.

The Application Container must override the methods that have a `Specific` suffix. These methods are:

- [ApplicationDescriptor\(String\)](#) - The Base class Application Descriptor takes the PID of the Application Descriptor as argument.
- [getPropertiesSpecific\(String\)](#) - Return the properties (including service properties) based on a specific locale. See the locale rules at *Application Descriptor Properties* on page 450. The Application Container must fill the returned Map object with the properties listed in Table 116.2 on page 450 as well as other service properties. Non-localized data is returned if the corresponding application container doesn't support the localization of application properties. Changes in the Map object must not be reflected in Application Descriptor properties.
- [launchSpecific\(Map\)](#) - Launch a new instance and return its handle. The container must ensure that the application is started in a `doPrivileged` block I.e. the permissions of the caller must not influence the capabilities of the started application.
- [lockSpecific\(\)](#) - Do the specific locking of the Application Descriptor.
- [unlockSpecific\(\)](#) - Do the specific unlocking of the Application Descriptor.
- [isLaunchableSpecific\(\)](#) - This method must return true when the application can be launched. This method can be called by the Application Descriptor implementation to find out if an application can be launched according to the container.

The specific methods must be made protected because the specific Application Descriptor is registered as a service and is intended to be used by a wide array of clients. These clients can call public methods so care should be taken to ensure that no intrusion can take place this way. The Applica-

tion Admin implementer must provide the implementation for the public methods and perform the appropriate security checks.

The specific Application Descriptor must be registered for each possible application with the set of service properties listed in Table 116.1 on page 449.

An application is launched with the `launchSpecific` method. This method is called by the Application Admin implementation, as implemented in the `ApplicationDescriptor` base class. The implementation of the `launchSpecific` method must return expediently. The Application Descriptor must perform the following steps (in the given order):

1. Create a new instance of the associated application
2. Start the application in another process or thread.
3. If the application cannot be started, an appropriate Exception must be thrown.
4. Register an Application Handle for this running application. The registration of the Application Handle must be accompanied by the service properties from Table 116.3 on page 452.
5. Return the new Application Handle.

### 116.3.2 The Application Handle

The Application Handle represents the running instance. The Application Container must extend the provided base class and implement the following methods:

- `ApplicationHandle(String,ApplicationDescriptor)` - The constructor of the base class takes the executable id and the Application Descriptor as parameter.
- `destroySpecific()` - Clients of the Application Admin specification use the destroy method on the Application Handle service to make an application instance quit. The Application Admin implementer must at an appropriate time call the `destroySpecific` method. The Application Container must destroy the application instance (if it had not destroyed already) and clean up.
- `getApplicationDescriptor()` - Return the Application Descriptor that belongs to this Application Handle.
- `getInstanceld()` - A unique id for this instance.
- `getState()` - Returns the state for the instance. The Application Admin specification only specifies two states: `RUNNING` and `STOPPING`. Application Containers can add new states to represent for example `PAUSED`. States are strings and must be qualified to prevent conflicts. For example, the Midlet state for paused could be `MIDLET.PAUSED`.

The most important method is `destroySpecific`. This method must perform the following actions in the given order:

1. Set the state to `STOPPING`
2. Modify the service properties of the Service Handle to reflect the new state. This sends out a service event.
3. If the application instance is active, use any proprietary mechanism to stop it. Any errors and problems should be logged.
4. Using proprietary means, clean up any resources on the system that were used by the application: locks, open files, etc.
5. Unregister the Application Handle service.

The Application container should monitor the progress of its instances. If an instance stops, for example due an exception or it quits voluntarily, the Application Container must call the `destroy` method on the Application Handle itself and handle the fact correctly that the instance is already stopped in the `destroySpecific` method.

### 116.3.3 Certificates

The following method on the Application Descriptor provides access to the certificate chain that was used to sign the application. This method is used by the Application Permission.

- `matchDNChain(String)` - Verifies that the given pattern matches one or more of the certificates that were used to sign the application. This method is primarily used by the Application Admin Permission to verify permissions. Matching certificates is described in *Certificate Matching of OSGi Core Release 6*.

### 116.3.4 Application Descriptor Example

This is an Application Container that scans a directory for executables. Each executable is registered as an Application Descriptor. The example assumes that there is a bundle activator that creates the Application Descriptor services. This activator must also ensure that when it is stopped no handles remain.

The example is not an robust implementation, its only intention is to show the concepts of the Application Admin specification in practice.

The (simple) Application Descriptor could look like:

```
public class SimpleDescriptor extends ApplicationDescriptor{
    ServiceRegistration registration;
    File executable;
    SimpleModel model;
    boolean locked;
    static URL genericIcon = SimpleDescriptor.class
        .getResource("icon.png");

    SimpleDescriptor(SimpleModel model, File executable) {
        super("com.acme." + executable.getName());
        this.model = model;
        this.executable = executable;
    }

    public Map getPropertiesSpecific(String locale) {
        Map map = new Hashtable();
        map.put(APPLICATION_ICON, genericIcon);
        map.put(APPLICATION_NAME, executable.getName());
        return map;
    }

    protected ApplicationHandle launchSpecific(
        final Map args) throws Exception {
        final SimpleDescriptor descriptor = this;

        return (ApplicationHandle) AccessController
            .doPrivileged(new PrivilegedExceptionAction() {
                public Object run() throws Exception {
                    SimpleHandle handle =
                        new SimpleHandle(descriptor, args);
                    handle.registration =
                        model.register(handle);
                    return handle;
                }
            });
    }
}
```

```

    }

    Dictionary getServiceProperties() {
        Hashtable p = new Hashtable();
        p.put(APPLICATION_LAUNCHABLE, Boolean.TRUE);
        p.put(APPLICATION_LOCKED, Boolean.valueOf(locked));
        p.put(Constants.SERVICE_PID, getApplicationId());
        return p;
    }

    protected void lockSpecific() { locked = true; }
    protected void unlockSpecific() { locked = false; }
    public boolean matchDNChain(String arg) { return false; }
    protected boolean isLaunchableSpecific() { return true; }
}

```

The associated Application Handle must launch the external executable and track its process. If the process dies autonomously or is stopped via the destroy method, it must unregister the Application Handle service. The class could be implemented like:

```

public class SimpleHandle extends
    ApplicationHandle implements Runnable {

    ServiceRegistration registration;
    Process                process;
    int                    instance;
    String                 state = RUNNING;
    static int             INSTANCE = 0;
    Thread                 thread;

    public SimpleHandle(SimpleDescriptor descriptor,
        Map arguments) throws IOException {
        super(descriptor.getApplicationId()
            + ":" + (INSTANCE++), descriptor);
        String path = descriptor.executable.getAbsolutePath();
        process = Runtime.getRuntime().exec(path);
        thread = new Thread(this, getInstanceId());
        thread.start();
    }

    public String getState() { return state; }

    protected void destroySpecific() throws Exception {
        state = STOPPING;
        registration.setProperties(getServiceProperties());
        thread.interrupt();
    }

    // Wait until process finishes or when
    // interrupted
    public void run() {
        try {
            process.waitFor();
            destroy();
        }
    }
}

```

```

        catch (InterruptedException ie) {
            process.destroy();
            try {
                process.waitFor();
            }
            catch (InterruptedException iee) {
                // Ignore
            }
        }
        catch( Exception e ) {
            .. logging
        }
        registration.unregister();
    }

    Dictionary getServiceProperties() {
        Hashtable p = new Hashtable();
        p.put(APPLICATION_PID, getInstanceId());
        p.put(APPLICATION_STATE, state);
        p.put(APPLICATION_DESCRIPTOR,
            getApplicationDescriptor().getApplicationId());
        return p;
    }
}

```

The Application Container must create the Application Descriptor services from some source. Care should be taken to optimize this scanning so that the initialization time is not significantly increased. Running application instances should be stopped if the Application Container is stopped. The following code shows a possible implementation:

```

public class SimpleModel implements BundleActivator{
    BundleContext context;
    Set          handles = new HashSet();

    public ServiceRegistration register(SimpleHandle handle){
        handles.add(handle);
        return context.registerService(
            ApplicationHandle.class.getName(),
            handle, handle.getServiceProperties());
    }

    public void start(BundleContext context) throws Exception
    {
        this.context = context;

        File file = new File("c:/windows");
        final SimpleModel me = this;

        file.list(new FilenameFilter() {
            public boolean accept(File dir, String name) {
                if (name.endsWith(".exe")) {
                    SimpleDescriptor sd = new SimpleDescriptor(me,
                        new File(dir, name));
                    sd.registration = me.context.registerService(
                        ApplicationDescriptor.class.getName(),

```

```

        sd, sd.getServiceProperties());
    }
    // We ignore the return anyway
    return false;
    });}

    public void stop(BundleContext context) throws Exception{
        for (Iterator handle = handles.iterator();
            handle.hasNext();) {
            SimpleHandle sh = (SimpleHandle) handle.next();
            try {
                sh.destroy();
            }
            catch (Exception e) {
                // We are cleaning up ...
            }
        }
    }
}
}
}

```

## 116.4 Application Admin Implementations

### 116.4.1 Implementing the Base Classes

The OSGi specified `org.osgi.service.application` package that is delivered with the specification in a JAR file is a dummy implementation. The intention of this package is to be replaced by an Application Admin implementation. This implementation can then enforce policies by intercepting the calls from any Application Managers to the Application Containers.

The Application Admin implementer must re-implement the following methods in the `ApplicationDescriptor` class:

- `launch(Map)` - The method can perform any checks before it must call the `launchSpecific(Map)` method. This must be a protected method. The implementation must perform any security checks. If these succeed, the `launchSpecific` method must not be called in a `doPrivileged` block.
- `lock()` - Must call the `lockSpecific` method.
- `unlock()` - Must call the `unlockSpecific` method.
- `schedule(String,Map,String,String,boolean)` - Register a new Scheduled Application service with the given arguments, thereby scheduling the application for launching when the topic and filter match an event. A virtual event is defined for timer based scheduling, see *Virtual Timer Event* on page 462.

The Application Admin implementer must also implement the following method in the `ApplicationHandle` class:

- `destroy()` - The Application Admin implementer should call the protected `destroySpecific()` method after which it should perform any possible cleanup operations.

Implementers must not change the signature of the public and protected parts of the `ApplicationDescriptor` and `ApplicationHandle` classes. Adding fields or methods, either public or protected is explicitly forbidden.

### 116.4.2 Exception Handling

The implementation of the container must ensure that Security Exceptions are only thrown during the invocation of any of the Application Descriptor methods when the required permissions are



lacking. If the Application Descriptor is not valid, an Illegal State Exception must be thrown and never a Security Exception.

### 116.4.3 Launching

The launch method of the Application Descriptor must be implemented by the Application Admin implementer. Launching must be performed in the following steps:

1. Verify that the caller has the appropriate permissions, see *Security* on page 464.
2. Verify that the Application Descriptor is not locked and launchable
3. Perform any policy actions that are deemed necessary before the application is really launched.
4. Call the protected launchSpecific method. If the method throws an Exception, then this exception should be logged, and must be re-thrown.
5. Otherwise, return the received Application Handle

### 116.4.4 Destroying

The implementation of the ApplicationHandle destroy method must follow the following steps:

1. Verify that the caller has the appropriate permissions, see *Security* on page 464.
2. Call the destroySpecific method. If an Exception is thrown, then this should be logged but must be further ignored.
3. Perform any cleanup deemed necessary.

### 116.4.5 Scheduling

Application Descriptor services can be scheduled by calling the schedule method, as described in *Scheduling* on page 453. This method must be implemented by the Application Admin implementer.

Application Admin implementations must make a reasonable effort to launch scheduled applications in a timely manner. However, launching is not guaranteed, implementations can drop and forget events if it is necessary in order to preserve the stability and integrity of the device. The granularity of the timer should also be taken into account, this granularity is one minute so the actual time an application will be launched can be shifted up to 60 seconds.

If an event would launch multiple applications then the order of launching is not defined, it is implementation specific.

Launching a scheduled application is constrained by the same rules as application launching. Thus, attempting to launch a locked application on the specified event must fail to launch. Launching can only succeed when the application is unlocked.

If the scheduling is non-recurring and launching a new instance fails then when the specified event occurs again launching the application must be attempted again until it succeeds. Non recurring schedules must be removed once the launch succeeds.

The triggering event will be delivered to the starting application instance as an additional item identified by the org.osgi.triggeringevent argument in its startup parameters. This property must not be used for other purposes in the startup parameters. To ensure that no events are leaked to applications without the appropriate permission, the event is delivered in a java.security.GuardedObject, where the guarding permission is the Topic Permission for the topic to which the event was posted.

Scheduling and unscheduling an application, or retrieving information about scheduled applications requires the Application Admin Permission for the target application to be scheduled. If the target is the unique identifier of the scheduling application itself then it can schedule itself. In addition, the scheduling entity must have Topic Permission for the specified topic.

## 116.4.6 Virtual Timer Event

The application scheduler can use a virtual timer event for time scheduled applications. This event is not actually sent out by the Event Admin; this virtual event is only used for the syntax to specify a recurring launch.

The topic name of this virtual timer event is:

```
org/osgi/application/timer
```

The properties of the virtual timer event are:

- `year` - (Integer) The year of the specified date. The value is defined by `Calendar.YEAR` field.
- `month` - (Integer) The month of the year. The value is defined by `Calendar.MONTH` field.
- `day_of_month` - (Integer) The day of the month. The value is defined by the `Calendar.DAY_OF_MONTH` field.
- `day_of_week` - (Integer) The day of the week. The value is defined by the `Calendar.DAY_OF_WEEK` field.
- `hour_of_day` - (Integer) The hour of the day. The value is defined by the `Calendar.HOUR_OF_DAY` field.
- `minute` - (Integer) The minute of the hour. The value is defined by the `Calendar.MINUTE` field.

The timer has a resolution of a minute. That is, it is not possible to schedule per second.

A property that is not included into the filter matches any value. Not including a field implies that it always matches. For example, if the `minute=0` clause from the filter is missing, the timer event will be fired every minute.

The following examples are filters for the timer event to specify certain time in the device local time. The topic is always `org/osgi/application/timer`.

Noon every day:

```
(&(hour_of_day=12) (minute=0))
```

Every whole hour, on every Sunday:

```
(&(day_of_week=0) (minute=0))
```

Every whole hour:

```
(minute=0)
```

## 116.5 Interaction

### 116.5.1 Application Installation

Figure 116.3 shows how an application manager can be notified about the installation of a new application. The actual installation may be done prior to the notification or may be done by the application container. At the end of the successful installation the application container must register a specialized Application Descriptor service which properly represents the installed application. If the installed application's dependencies are fulfilled (which are container specific) then the application descriptor's `application.visible` and `application.launchable` properties should be set to true.

Figure 116.3 Installing a bundle that is managed by an Application Container

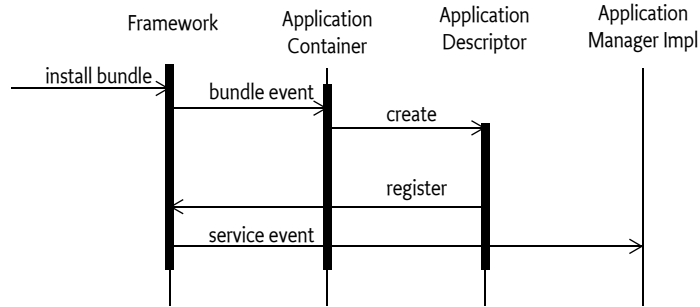

### 116.5.2 Launching an Application

Firstly the appropriate Application Descriptor service on which the operation will be made is fetched from the service registry. This Application Descriptor is a container specific sub-class of the Application Descriptor class. Its launch method is called which is in the base class.

The application instance may not receive the startup arguments if its application container does not support startup arguments. The launch method checks if the a new application instance can be launched, for example, that the necessary rights are granted, the application is not locked and the application is not a singleton that already has an instance.

If the application can be launched then the launchSpecific method, which is in the subclass, will create and start a new application instance according to its application container. It will create a specific application handle and associate the newly created application instance to it. The launchSpecific method will register the application handle with proper service properties. The value of application.state service property must be RUNNING. The call chain returns the application handle.

Figure 116.4 Launching an application

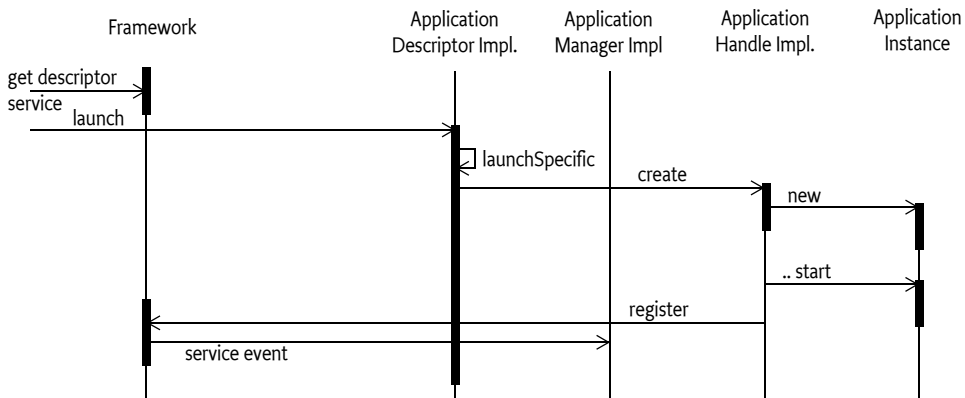

### 116.5.3 Destroying an Application Instance

To destroy an application, the proper application handle has to be fetched from the service registry to call its destroy() method. It checks if the instance can be destroyed, for example that the necessary permissions are granted, it then calls the destroySpecific method to let its implementation destroy the instance in an application container specific way. First, it sets the application.state service property to STOPPING then stops the application instance. Finally it unregisters the application handle.

## 116.6 Security

The Application Admin specification is an interaction of the:

- *Application Container implementers*
- *Applications*
- *Application Managers*

There are two permissions used in the security model of the Application Admin specification. The first is the Service Permission that grants access to getting or registering the Application Descriptor and Application Handle services. The second security is specific for the Application Admin specification and is the Application Permission.

The Application Container must be very powerful because it starts the application code, which should be able to perform almost any function.

The security checks are performed in the ApplicationDescriptor and ApplicationHandle base classes.

### 116.6.1 Application Admin Permissions

This ApplicationAdminPermission class implements permissions for manipulating applications and their instances. The permission must be held by any bundle that manipulates application descriptors or application handles.

The target of the Application Admin Permission is an OSGi filter that matches a number of properties. This is similar to the Admin Permission in the Framework. Alternatively, instead of the filter the pseudo target <<SELF>> can be used.

The following properties can be tested in the filter:

- *signer* - A Distinguished Name chain that is used to sign the application. The matching of this property must be done according to the rules described for DN matching in *OSGi Core Release 6*. The Application Admin Permission must use the ApplicationDescriptor class' matchDNChain method. Matching DN's is described in *Certificate Matching of OSGi Core Release 6*.
- *pid* - The PID of the target application.

The pseudo target <<SELF>> indicates that the calling application is allowed to manipulate its own descriptors and handlers.

The following actions can be granted:

- [SCHEDULE\\_ACTION](#) - The caller is allowed to schedule an application., i.e. call the ApplicationDescriptor schedule method. This action implies [LIFECYCLE\\_ACTION](#).
- [LIFECYCLE\\_ACTION](#) - The caller is allowed to manipulate the life cycle state of an application instance: launch and destroy.
- [LOCK\\_ACTION](#) - The caller is allowed to the lock and unlock methods.

### 116.6.2 Service and Package Permissions

#### 116.6.2.1 Application Admin Implementation

The Application Admin implementation must have the following permissions:

ServicePermission	..ScheduledApplication	REGISTER
ServicePermission	..ApplicationDescriptor	GET
ServicePermission	..ApplicationHandle	GET
PackagePermission	org.osgi.service.application	EXPORTONLY

ServicePermission	..ApplicationDescriptor	GET
ServicePermission	..ApplicationHandle	GET
ApplicationAdminPermission	*	*

### 116.6.2.2 Application Container

ServicePermission	..ApplicationDescriptor	REGISTER
ServicePermission	..ApplicationHandle	REGISTER
PackagePermission	org.osgi.service.application	IMPORT

Additionally, an Application Container requires all the permissions that are needed to run the applications. This is likely to be All Permission.

## 116.7 org.osgi.service.application

Application Package Version 1.1.

Bundles wishing to use this package must list the package in the Import-Package header of the bundle's manifest. This package has two types of users: the consumers that use the API in this package and the providers that implement the API in this package.

Example import for consumers using the API in this package:

```
Import-Package: org.osgi.service.application; version="[1.1,2.0)"
```

Example import for providers implementing the API in this package:

```
Import-Package: org.osgi.service.application; version="[1.1,1.2)"
```

### 116.7.1 Summary

- ApplicationAdminPermission - This class implements permissions for manipulating applications and their instances.
- ApplicationDescriptor - An OSGi service that represents an installed application and stores information about it.
- ApplicationException - This exception is used to indicate problems related to application lifecycle management.
- ApplicationHandle - ApplicationHandle is an OSGi service interface which represents an instance of an application.
- ScheduledApplication - It is allowed to schedule an application based on a specific event.

### 116.7.2 public class ApplicationAdminPermission extends Permission

This class implements permissions for manipulating applications and their instances.

ApplicationAdminPermission can be targeted to applications that matches the specified filter.

ApplicationAdminPermission may be granted for different actions: lifecycle, schedule and lock. The permission schedule implies the permission lifecycle.

#### 116.7.2.1 public static final String LIFECYCLE\_ACTION = "lifecycle"

Allows the lifecycle management of the target applications.

#### 116.7.2.2 public static final String LOCK\_ACTION = "lock"

Allows setting/unsetting the locking state of the target applications.

**116.7.2.3 public static final String SCHEDULE\_ACTION = "schedule"**

Allows scheduling of the target applications. The permission to schedule an application implies that the scheduler can also manage the lifecycle of that application i.e. schedule implies lifecycle

**116.7.2.4 public ApplicationAdminPermission(String filter,String actions) throws InvalidSyntaxException**

*filter* filter to identify application. The value null is equivalent to "\*" and it indicates "all application".

*actions* comma-separated list of the desired actions granted on the applications or "\*" means all the actions. It must not be null. The order of the actions in the list is not significant.

- Constructs an ApplicationAdminPermission. The filter specifies the target application. The filter is an LDAP-style filter, the recognized properties are signer and pid. The pattern specified in the signer is matched with the Distinguished Name chain used to sign the application. Wildcards in a DN are not matched according to the filter string rules, but according to the rules defined for a DN chain. The attribute pid is matched with the PID of the application according to the filter string rules.

If the filter is null then it matches "\*". If actions is "\*" then it identifies all the possible actions.

*Throws* InvalidSyntaxException– is thrown if the specified filter is not syntactically correct.

NullPointerException– is thrown if the actions parameter is null

*See Also* ApplicationDescriptor, org.osgi.framework.AdminPermission

**116.7.2.5 public ApplicationAdminPermission(ApplicationDescriptor application,String actions)**

*application* The target of the operation, it must not be null.

*actions* The required operation, it must not be null.

- This constructor should be used when creating ApplicationAdminPermission instance for checkPermission call.

*Throws* NullPointerException– If any of the arguments is null.

**116.7.2.6 public boolean equals(Object with)****116.7.2.7 public String getActions()**

- Returns the actions of this permission.

*Returns* the actions specified when this permission was created

**116.7.2.8 public int hashCode()****116.7.2.9 public boolean implies(Permission otherPermission)**

*otherPermission* the implied permission

- Checks if the specified permission is implied by this permission. The method returns true under the following conditions:
  - This permission was created by specifying a filter (see ApplicationAdminPermission(String, String))
  - The implied otherPermission was created for a particular ApplicationDescriptor (see ApplicationAdminPermission(ApplicationDescriptor, String))
  - The filter of this permission matches the ApplicationDescriptor specified in the otherPermission. If the filter in this permission is the <<SELF>> pseudo target, then the currentApplicationId set in the otherPermission is compared to the application Id of the target ApplicationDescriptor.
  - The list of permitted actions in this permission contains all actions required in the otherPermission

Otherwise the method returns false.

*Returns* true if this permission implies the otherPermission, false otherwise.

### 116.7.2.10 **public ApplicationAdminPermission setCurrentApplicationId(String applicationId)**

*applicationId* the ID of the current application.

- This method can be used in the java.security.ProtectionDomain implementation in the implies method to insert the application ID of the current application into the permission being checked. This enables the evaluation of the <<SELF>> pseudo targets.

*Returns* the permission updated with the ID of the current application

## 116.7.3 **public abstract class ApplicationDescriptor**

An OSGi service that represents an installed application and stores information about it. The application descriptor can be used for instance creation.

### 116.7.3.1 **public static final String APPLICATION\_CONTAINER = "application.container"**

The property key for the application container of the application.

### 116.7.3.2 **public static final String APPLICATION\_COPYRIGHT = "application.copyright"**

The property key for the localized copyright notice of the application.

### 116.7.3.3 **public static final String APPLICATION\_DESCRIPTION = "application.description"**

The property key for the localized description of the application.

### 116.7.3.4 **public static final String APPLICATION\_DOCUMENTATION = "application.documentation"**

The property key for the localized documentation of the application.

### 116.7.3.5 **public static final String APPLICATION\_ICON = "application.icon"**

The property key for the localized icon of the application.

### 116.7.3.6 **public static final String APPLICATION\_LAUNCHABLE = "application.launchable"**

The property key for the launchable property of the application.

### 116.7.3.7 **public static final String APPLICATION\_LICENSE = "application.license"**

The property key for the localized license of the application.

### 116.7.3.8 **public static final String APPLICATION\_LOCATION = "application.location"**

The property key for the location of the application.

### 116.7.3.9 **public static final String APPLICATION\_LOCKED = "application.locked"**

The property key for the locked property of the application.

### 116.7.3.10 **public static final String APPLICATION\_NAME = "application.name"**

The property key for the localized name of the application.

### 116.7.3.11 **public static final String APPLICATION\_PID = "service.pid"**

The property key for the unique identifier (PID) of the application.

### 116.7.3.12 **public static final String APPLICATION\_VENDOR = "service.vendor"**

The property key for the name of the application vendor.

### 116.7.3.13 **public static final String APPLICATION\_VERSION = "application.version"**

The property key for the version of the application.

**116.7.3.14 public static final String APPLICATION\_VISIBLE = "application.visible"**

The property key for the visibility property of the application.

**116.7.3.15 protected ApplicationDescriptor(String applicationId)**

*applicationId* The identifier of the application. Its value is also available as the service.pid service property of this ApplicationDescriptor service. This parameter must not be null.

- Constructs the ApplicationDescriptor.

*Throws* NullPointerException– if the specified applicationId is null.

**116.7.3.16 public final String getApplicationId()**

- Returns the identifier of the represented application.

*Returns* the identifier of the represented application

**116.7.3.17 public final Map getProperties(String locale)**

*locale* the locale string, it may be null, the value null means the default locale. If the provided locale is the empty String (""), then raw (non-localized) values are returned.

- Returns the properties of the application descriptor as key-value pairs. The return value contains the locale aware and unaware properties as well. The returned Map will include the service properties of this ApplicationDescriptor as well.

This method will call the `getPropertiesSpecific` method to enable the container implementation to insert application model and/or container implementation specific properties.

The returned `java.util.Map` will contain the standard OSGi service properties as well (e.g. `service.id`, `service.vendor` etc.) and specialized application descriptors may offer further service properties. The returned Map contains a snapshot of the properties. It will not reflect further changes in the property values nor will the update of the Map change the corresponding service property.

*Returns* copy of the service properties of this application descriptor service, according to the specified locale. If locale is null then the default locale's properties will be returned. (Since service properties are always exist it cannot return null.)

*Throws* IllegalStateException– if the application descriptor is unregistered

**116.7.3.18 protected abstract Map getPropertiesSpecific(String locale)**

*locale* the locale to be used for localizing the properties. If null the default locale should be used. If it is the empty String (""), then raw (non-localized) values should be returned.

- Container implementations can provide application model specific and/or container implementation specific properties via this method. Localizable properties must be returned localized if the provided locale argument is not the empty String. The value null indicates to use the default locale, for other values the specified locale should be used. The returned `java.util.Map` must contain the standard OSGi service properties as well (e.g. `service.id`, `service.vendor` etc.) and specialized application descriptors may offer further service properties. The returned Map contains a snapshot of the properties. It will not reflect further changes in the property values nor will the update of the Map change the corresponding service property.

*Returns* the application model specific and/or container implementation specific properties of this application descriptor.

*Throws* IllegalStateException– if the application descriptor is unregistered

**116.7.3.19 protected abstract boolean isLaunchableSpecific()**

- This method is called by `launch()` to verify that according to the container, the application is launchable.



*Returns* true, if the application is launchable according to the container, false otherwise.

*Throws* `IllegalStateException`– if the application descriptor is unregistered

### 116.7.3.20 **public final ApplicationHandle launch(Map arguments) throws ApplicationException**

*arguments* Arguments for the newly launched application, may be null

- Launches a new instance of an application. The `args` parameter specifies the startup parameters for the instance to be launched, it may be null.

The following steps are made:

- Check for the appropriate permission.
- Check the locking state of the application. If locked then throw an `ApplicationException` with the reason code `ApplicationException.APPLICATION_LOCKED`.
- Calls the `launchSpecific()` method to create and start an application instance.
- Returns the `ApplicationHandle` returned by the `launchSpecific()`

The caller has to have `ApplicationAdminPermission(applicationPID, "launch")` in order to be able to perform this operation.

The `Map` argument of the `launch` method contains startup arguments for the application. The keys used in the `Map` must be non-null, non-empty `String` objects. They can be standard or application specific. OSGi defines the `org.osgi.triggeringevent` key to be used to pass the triggering event to a scheduled application, however in the future it is possible that other well-known keys will be defined. To avoid unwanted clashes of keys, the following rules should be applied:

- The keys starting with the dash (-) character are application specific, no well-known meaning should be associated with them.
- Well-known keys should follow the reverse domain name based naming. In particular, the keys standardized in OSGi should start with `org.osgi..`

The method is synchronous, it return only when the application instance was successfully started or the attempt to start it failed.

This method never returns null. If launching an application fails, the appropriate exception is thrown.

*Returns* the registered `ApplicationHandle`, which represents the newly launched application instance. Never returns null.

*Throws* `SecurityException`– if the caller doesn't have "lifecycle" `ApplicationAdminPermission` for the application.

`ApplicationException`– if starting the application failed

`IllegalStateException`– if the application descriptor is unregistered

`IllegalArgumentException`– if the specified `Map` contains invalid keys (null objects, empty `String` or a key that is not `String`)

### 116.7.3.21 **protected abstract ApplicationHandle launchSpecific(Map arguments) throws Exception**

*arguments* the startup parameters of the new application instance, may be null

- Called by `launch()` to create and start a new instance in an application model specific way. It also creates and registers the application handle to represent the newly created and started instance and registers it. The method is synchronous, it return only when the application instance was successfully started or the attempt to start it failed.

This method must not return null. If launching the application failed, and exception must be thrown.

*Returns* the registered application model specific application handle for the newly created and started instance.

*Throws* `IllegalStateException`– if the application descriptor is unregistered  
`Exception`– if any problem occurs.

### 116.7.3.22 **public final void lock()**

- Sets the lock state of the application. If an application is locked then launching a new instance is not possible. It does not affect the already launched instances.

*Throws* `SecurityException`– if the caller doesn't have "lock" `ApplicationAdminPermission` for the application.

`IllegalStateException`– if the application descriptor is unregistered

### 116.7.3.23 **protected abstract void lockSpecific()**

- This method is used to notify the container implementation that the corresponding application has been locked and it should update the `application.locked` service property accordingly.

*Throws* `IllegalStateException`– if the application descriptor is unregistered

### 116.7.3.24 **public abstract boolean matchDNChain(String pattern)**

*pattern* a pattern for a chain of Distinguished Names. It must not be null.

- This method verifies whether the specified pattern matches the Distinguished Names of any of the certificate chains used to authenticate this application.

The pattern must adhere to the syntax defined in `org.osgi.service.application.ApplicationAdminPermission` for signer attributes.

This method is used by `ApplicationAdminPermission.implies(java.security.Permission)` method to match target `ApplicationDescriptor` and filter.

*Returns* true if the specified pattern matches at least one of the certificate chains used to authenticate this application

*Throws* `NullPointerException`– if the specified pattern is null.

`IllegalStateException`– if the application descriptor was unregistered

### 116.7.3.25 **public final ScheduledApplication schedule(String scheduleId, Map arguments, String topic, String eventFilter, boolean recurring) throws InvalidSyntaxException, ApplicationException**

*scheduleId* the identifier of the created schedule. It can be null, in this case the identifier is automatically generated.

*arguments* the startup arguments for the scheduled application, may be null

*topic* specifies the topic of the triggering event, it may contain a trailing asterisk as wildcard, the empty string is treated as "\*", must not be null

*eventFilter* specifies and LDAP filter to filter on the properties of the triggering event, may be null

*recurring* if the recurring parameter is false then the application will be launched only once, when the event firstly occurs. If the parameter is true then scheduling will take place for every event occurrence; i.e. it is a recurring schedule

- Schedules the application at a specified event. Schedule information should not get lost even if the framework or the device restarts so it should be stored in a persistent storage. The method registers a `ScheduledApplication` service in Service Registry, representing the created schedule.

The Map argument of the method contains startup arguments for the application. The keys used in the Map must be non-null, non-empty String objects. The argument values must be of primitive types, wrapper classes of primitive types, String or arrays or collections of these.

The created schedules have a unique identifier within the scope of this ApplicationDescriptor. This identifier can be specified in the scheduleId argument. If this argument is null, the identifier is automatically generated.

*Returns* the registered scheduled application service

*Throws* NullPointerException– if the topic is null

InvalidSyntaxException– if the specified eventFilter is not syntactically correct

ApplicationException– if the schedule couldn't be created. The possible error codes are

- ApplicationException.APPLICATION\_DUPLICATE\_SCHEDULE\_ID if the specified scheduleId is already used for this ApplicationDescriptor
- ApplicationException.APPLICATION\_SCHEDULING\_FAILED if the scheduling failed due to some internal reason (e.g. persistent storage error).
- ApplicationException.APPLICATION\_INVALID\_STARTUP\_ARGUMENT if the specified startup argument doesn't satisfy the type or value constraints of startup arguments.

SecurityException– if the caller doesn't have "schedule" ApplicationAdminPermission for the application.

IllegalStateException– if the application descriptor is unregistered

IllegalArgumentException– if the specified Map contains invalid keys (null objects, empty String or a key that is not String)

#### 116.7.3.26 **public final void unlock()**

- Unsets the lock state of the application.

*Throws* SecurityException– if the caller doesn't have "lock" ApplicationAdminPermission for the application.

IllegalStateException– if the application descriptor is unregistered

#### 116.7.3.27 **protected abstract void unlockSpecific()**

- This method is used to notify the container implementation that the corresponding application has been unlocked and it should update the application.locked service property accordingly.

*Throws* IllegalStateException– if the application descriptor is unregistered

### 116.7.4 **public class ApplicationException extends Exception**

This exception is used to indicate problems related to application lifecycle management. ApplicationException object is created by the Application Admin to denote an exception condition in the lifecycle of an application. ApplicationExceptions should not be created by developers. ApplicationExceptions are associated with an error code. This code describes the type of problem reported in this exception. The possible codes are:

- APPLICATION\_LOCKED - The application couldn't be launched because it is locked.
- APPLICATION\_NOT\_LAUNCHABLE - The application is not in launchable state.
- APPLICATION\_INTERNAL\_ERROR - An exception was thrown by the application or its container during launch.
- APPLICATION\_SCHEDULING\_FAILED - The scheduling of an application failed.

- `APPLICATION_DUPLICATE_SCHEDULE_ID` - The application scheduling failed because the specified identifier is already in use.
- `APPLICATION_EXITVALUE_NOT_AVAILABLE` - The exit value is not available for an application instance because the instance has not terminated.
- `APPLICATION_INVALID_STARTUP_ARGUMENT` - One of the specified startup arguments is invalid, for example its type is not permitted.

**116.7.4.1**      **public static final int APPLICATION\_DUPLICATE\_SCHEDULE\_ID = 5**

The application scheduling failed because the specified identifier is already in use.

**116.7.4.2**      **public static final int APPLICATION\_EXITVALUE\_NOT\_AVAILABLE = 6**

The exit value is not available for an application instance because the instance has not terminated.

*Since* 1.1

**116.7.4.3**      **public static final int APPLICATION\_INTERNAL\_ERROR = 3**

An exception was thrown by the application or the corresponding container during launch. The exception is available from `getCause()`.

**116.7.4.4**      **public static final int APPLICATION\_INVALID\_STARTUP\_ARGUMENT = 7**

One of the specified startup arguments is invalid, for example its type is not permitted.

*Since* 1.1

**116.7.4.5**      **public static final int APPLICATION\_LOCKED = 1**

The application couldn't be launched because it is locked.

**116.7.4.6**      **public static final int APPLICATION\_NOT\_LAUNCHABLE = 2**

The application is not in launchable state, it's `ApplicationDescriptor.APPLICATION_LAUNCHABLE` attribute is false.

**116.7.4.7**      **public static final int APPLICATION\_SCHEDULING\_FAILED = 4**

The application schedule could not be created due to some internal error (for example, the schedule information couldn't be saved due to some storage error).

**116.7.4.8**      **public ApplicationException(int errorCode)**

*errorCode* The code of the error

- Creates an `ApplicationException` with the specified error code.

**116.7.4.9**      **public ApplicationException(int errorCode,Throwable cause)**

*errorCode* The code of the error

*cause* The cause of this exception.

- Creates a `ApplicationException` that wraps another exception.

**116.7.4.10**      **public ApplicationException(int errorCode,String message)**

*errorCode* The code of the error

*message* The associated message

- Creates an `ApplicationException` with the specified error code.

**116.7.4.11**      **public ApplicationException(int errorCode,String message,Throwable cause)**

*errorCode* The code of the error

*message* The associated message.

*cause* The cause of this exception.

- Creates a `ApplicationException` that wraps another exception.

#### 116.7.4.12 **public Throwable getCause()**

- Returns the cause of this exception or null if no cause was set.

*Returns* The cause of this exception or null if no cause was set.

#### 116.7.4.13 **public int getErrorCode()**

- Returns the error code associated with this exception.

*Returns* The error code of this exception.

### 116.7.5 **public abstract class ApplicationHandle**

`ApplicationHandle` is an OSGi service interface which represents an instance of an application. It provides the functionality to query and manipulate the lifecycle state of the represented application instance. It defines constants for the lifecycle states.

#### 116.7.5.1 **public static final String APPLICATION\_DESCRIPTOR = "application.descriptor"**

The property key for the pid of the corresponding application descriptor.

#### 116.7.5.2 **public static final String APPLICATION\_PID = "service.pid"**

The property key for the unique identifier (PID) of the application instance.

#### 116.7.5.3 **public static final String APPLICATION\_STATE = "application.state"**

The property key for the state of this application instance.

#### 116.7.5.4 **public static final String APPLICATION\_SUPPORTS\_EXITVALUE = "application.supports.exitvalue"**

The property key for the supports exit value property of this application instance.

*Since* 1.1

#### 116.7.5.5 **public static final String RUNNING = "RUNNING"**

The application instance is running. This is the initial state of a newly created application instance.

#### 116.7.5.6 **public static final String STOPPING = "STOPPING"**

The application instance is being stopped. This is the state of the application instance during the execution of the `destroy()` method.

#### 116.7.5.7 **protected ApplicationHandle(String instanceId, ApplicationDescriptor descriptor)**

*instanceId* the instance identifier of the represented application instance. It must not be null.

*descriptor* the `ApplicationDescriptor` of the represented application instance. It must not be null.

- Application instance identifier is specified by the container when the instance is created. The instance identifier must remain static for the lifetime of the instance, it must remain the same even across framework restarts for the same application instance. This value must be the same as the `service.pid` service property of this application handle.

The instance identifier should follow the following scheme: `<application descriptor PID>.<index>` where `<application descriptor PID>` is the PID of the corresponding `ApplicationDescriptor` and `<index>` is a unique integer index assigned by the application container. Even after destroying the application index the same index value should not be reused in a reasonably long timeframe.

*Throws* `NullPointerException`—if any of the arguments is null.

**116.7.5.8 public final void destroy()**

- The application instance's lifecycle state can be influenced by this method. It lets the application instance perform operations to stop the application safely, e.g. saving its state to a permanent storage.

The method must check if the lifecycle transition is valid; a STOPPING application cannot be stopped. If it is invalid then the method must exit. Otherwise the lifecycle state of the application instance must be set to STOPPING. Then the `destroySpecific()` method must be called to perform any application model specific steps for safe stopping of the represented application instance.

At the end the `ApplicationHandle` must be unregistered. This method should free all the resources related to this `ApplicationHandle`.

When this method is completed the application instance has already made its operations for safe stopping, the `ApplicationHandle` has been unregistered and its related resources has been freed. Further calls on this application should not be made because they may have unexpected results.

*Throws* `SecurityException`– if the caller doesn't have "lifecycle" `ApplicationAdminPermission` for the corresponding application.

`IllegalStateException`– if the application handle is unregistered

**116.7.5.9 protected abstract void destroySpecific()**

- Called by the `destroy()` method to perform application model specific steps to stop and destroy an application instance safely.

*Throws* `IllegalStateException`– if the application handle is unregistered

**116.7.5.10 public final ApplicationDescriptor getApplicationDescriptor()**

- Retrieves the `ApplicationDescriptor` to which this `ApplicationHandle` belongs.

*Returns* The corresponding `ApplicationDescriptor`

**116.7.5.11 public Object getExitValue(long timeout) throws ApplicationException, InterruptedException**

*timeout* The maximum time in milliseconds to wait for the application to timeout.

- Returns the exit value for the application instance. The timeout specifies how the method behaves when the application has not yet terminated. A negative, zero or positive value may be used.
  - negative - The method does not wait for termination. If the application has not terminated then an `ApplicationException` is thrown.
  - zero - The method waits until the application terminates.
  - positive - The method waits until the application terminates or the timeout expires. If the timeout expires and the application has not terminated then an `ApplicationException` is thrown.

The default implementation throws an `UnsupportedOperationException`. The application model should override this method if exit values are supported.

*Returns* The exit value for the application instance. The value is application specific.

*Throws* `UnsupportedOperationException`– If the application model does not support exit values.

`InterruptedException`– If the thread is interrupted while waiting for the timeout.

`ApplicationException`– If the application has not terminated. The error code will be `ApplicationException.APPLICATION_EXITVALUE_NOT_AVAILABLE`.

*Since* 1.1

**116.7.5.12 public final String getInstanceId()**

- Returns the unique identifier of this instance. This value is also available as a service property of this application handle's `service.pid`.

*Returns* the unique identifier of the instance

### 116.7.5.13 **public abstract String getState()**

- Get the state of the application instance.

*Returns* the state of the application.

*Throws* `IllegalStateException`— if the application handle is unregistered

## 116.7.6 **public interface ScheduledApplication**

It is allowed to schedule an application based on a specific event. `ScheduledApplication` service keeps the schedule information. When the specified event is fired a new instance must be launched. Note that launching operation may fail because e.g. the application is locked.

Each `ScheduledApplication` instance has an identifier which is unique within the scope of the application being scheduled.

`ScheduledApplication` instances are registered as services. The `APPLICATION_PID` service property contains the PID of the application being scheduled, the `SCHEDULE_ID` service property contains the schedule identifier.

### 116.7.6.1 **public static final String APPLICATION\_PID = "service.pid"**

The property key for the identifier of the application being scheduled.

### 116.7.6.2 **public static final String DAY\_OF\_MONTH = "day\_of\_month"**

The name of the *day of month* attribute of a virtual timer event. The value is defined by `java.util.Calendar.DAY_OF_MONTH`.

### 116.7.6.3 **public static final String DAY\_OF\_WEEK = "day\_of\_week"**

The name of the *day of week* attribute of a virtual timer event. The value is defined by `java.util.Calendar.DAY_OF_WEEK`.

### 116.7.6.4 **public static final String HOUR\_OF\_DAY = "hour\_of\_day"**

The name of the *hour of day* attribute of a virtual timer event. The value is defined by `java.util.Calendar.HOUR_OF_DAY`.

### 116.7.6.5 **public static final String MINUTE = "minute"**

The name of the *minute* attribute of a virtual timer event. The value is defined by `java.util.Calendar.MINUTE`.

### 116.7.6.6 **public static final String MONTH = "month"**

The name of the *month* attribute of a virtual timer event. The value is defined by `java.util.Calendar.MONTH`.

### 116.7.6.7 **public static final String SCHEDULE\_ID = "schedule.id"**

The property key for the schedule identifier. The identifier is unique within the scope of the application being scheduled.

### 116.7.6.8 **public static final String TIMER\_TOPIC = "org/osgi/application/timer"**

The topic name for the virtual timer topic. Time based schedules should be created using this topic.

### 116.7.6.9 **public static final String TRIGGERING\_EVENT = "org.osgi.triggeringevent"**

The key for the startup argument used to pass the event object that triggered the schedule to launch the application instance. The event is passed in a `java.security.GuardedObject` protected by the corresponding `org.osgi.service.event.TopicPermission`.

- 116.7.6.10**      **public static final String YEAR = "year"**
- The name of the *year* attribute of a virtual timer event. The value is defined by `java.util.Calendar.YEAR`.
- 116.7.6.11**      **public ApplicationDescriptor getApplicationDescriptor()**
- Retrieves the `ApplicationDescriptor` which represents the application and necessary for launching.
- Returns* the application descriptor that represents the scheduled application
- Throws* `IllegalStateException`– if the scheduled application service is unregistered
- 116.7.6.12**      **public Map getArguments()**
- Queries the startup arguments specified when the application was scheduled. The method returns a copy of the arguments, it is not possible to modify the arguments after scheduling.
- Returns* the startup arguments of the scheduled application. It may be null if null argument was specified.
- Throws* `IllegalStateException`– if the scheduled application service is unregistered
- 116.7.6.13**      **public String getEventFilter()**
- Queries the event filter for the triggering event.
- Returns* the event filter for triggering event
- Throws* `IllegalStateException`– if the scheduled application service is unregistered
- 116.7.6.14**      **public String getScheduleId()**
- Returns the identifier of this schedule. The identifier is unique within the scope of the application that the schedule is related to.
- Returns* the identifier of this schedule
- 116.7.6.15**      **public String getTopic()**
- Queries the topic of the triggering event. The topic may contain a trailing asterisk as wildcard.
- Returns* the topic of the triggering event
- Throws* `IllegalStateException`– if the scheduled application service is unregistered
- 116.7.6.16**      **public boolean isRecurring()**
- Queries if the schedule is recurring.
- Returns* `true` if the schedule is recurring, otherwise returns `false`
- Throws* `IllegalStateException`– if the scheduled application service is unregistered
- 116.7.6.17**      **public void remove()**
- Cancels this schedule of the application.
- Throws* `SecurityException`– if the caller doesn't have "schedule" `ApplicationAdminPermission` for the scheduled application.
- `IllegalStateException`– if the scheduled application service is unregistered

## 116.8 References

- [1] *PNG Image Format*  
<http://www.libpng.org/pub/png/>



# 117 Dmt Admin Service Specification

## Version 2.0

### 117.1 Introduction

There are a large number of Device Management standards available today. Starting with the ITU X.700 series in the seventies, SNMP in the eighties and then an explosion of different protocols when the use of the Internet expanded in the nineties. Many device management standards have flourished, and some subsequently withered, over the last decades. Some examples:

- X.700 CMIP
- IETF SNMP
- IETF LDAP
- OMA DM
- Broadband Forum TR-069
- UPnP Forum's Device Management
- IETF NETCONF
- OASIS WS Distributed Management

This heterogeneity of the remote management for OSGi Framework based devices is a problem for device manufacturers. Since there is often no dominant protocol these manufacturers have to develop multiple solutions for different remote management protocols. It is also problematic for device operators since they have to choose a specific protocol but by that choice could exclude a class of devices that do not support that protocol. There is therefore a need to allow the use of multiple protocols at minimal costs.

Almost all management standards are based on hierarchical object models and provide *primitives* like:

- Get and replace values
- Add/Remove instances
- Discovery of value names and instance ids
- Provide notifications

A Device Management standard consists of a *protocol stack* and a number of *object models*. The protocol stack is generic and shared for all object types; the object model describes a specific device's properties and methods. For example, the protocol stack can consist of a set of SOAP message formats and an object model is a Deployment Unit. An object model consists of a data model and sometimes a set of functions.

The core problem is that the generic Device Management Tree must be mapped to device specific functions. This specification therefore defines an API for managing a device using general device management concepts but providing an effective plugin model to link the generic tree to the specific device functions.

The API is decomposed in the following packages/functionality:

- `org.osgi.service.dmt` - Main package that provides access to the local Device Management Tree. Access is session based.

- `org.osgi.service.dmt.notification` - The notification package provides the capability to send alerts to a management server.
- `org.osgi.service.dmt.spi` - Provides the capability to register subtree handlers in the Device Management Tree.
- `org.osgi.service.dmt.notification.spi` - The API to provide the possibility to extend the notification system.
- `org.osgi.service.dmt.security` - Permission classes.

### 117.1.1

## Entities

- *Device Management Tree* - The Device Management Tree (DMT) is the logical view of manageable aspects of an OSGi Environment, implemented by plugins and structured in a tree with named nodes.
- *Dmt Admin* - A service through which the DMT can be manipulated. It is used by *Local Managers* or by *Protocol Adapters* that initiate DMT operations. The Dmt Admin service forwards selected DMT operations to Data Plugins and execute operations to Exec Plugins; in certain cases the Dmt Admin service handles the operations itself. The Dmt Admin service is a singleton.
- *Dmt Session* - A session groups a set of operations on a sub-tree with optional transactionality and locking. Dmt Session objects are created by the Dmt Admin service and are given to a plugin when they first join the session.
- *Local Manager* - A bundle which uses the Dmt Admin service directly to read or manipulate the DMT. Local Managers usually do not have a principal associated with the session.
- *Protocol Adapter* - A bundle that communicates with a management server external to the device and uses the Dmt Admin service to operate on the DMT. Protocol Adapters usually have a principal associated with their sessions.
- *Meta Node* - Information provided by the node implementer about a node for the purpose of performing validation and providing assistance to users when these values are edited.
- *Multi nodes* - Interior nodes that have a homogeneous set of children. All these children share the same meta node.
- *Plugin* - Services which take the responsibility over a given sub-tree of the DMT: Data Plugin services and Exec Plugin services.
- *Data Plugin* - A Plugin that can create a Readable Data Session, Read Write Data Session, or Transactional Data Session for data operations on a sub-tree for a Dmt Session.
- *Exec Plugin* - A Plugin that can handle execute operations.
- *Readable Data Session* - A plugin session that can only read.
- *Read Write Data Session* - A plugin session that can read and write.
- *Transactional Data Session* - A plugin session that is transactional.
- *Principal* - Represents the optional identity of an initiator of a Dmt Session. When a session has a principal, the Dmt Admin must enforce ACLs and must ignore Dmt Permissions.
- *ACL* - An Access Control List is a set of principals that is associated with permitted operations.
- *Dmt Event* - Information about a modification of the DMT.
- *Dmt Event Listener* - Listeners to Dmt Events. These listeners are services according to the white board pattern.
- *Mount Point* - A point in the DMT where a Plugin or the Dmt Admin service allows other Plugins to have their root.

The overall service interaction diagram is depicted in Figure 117.1.

Figure 117.1 Overall Service Diagram

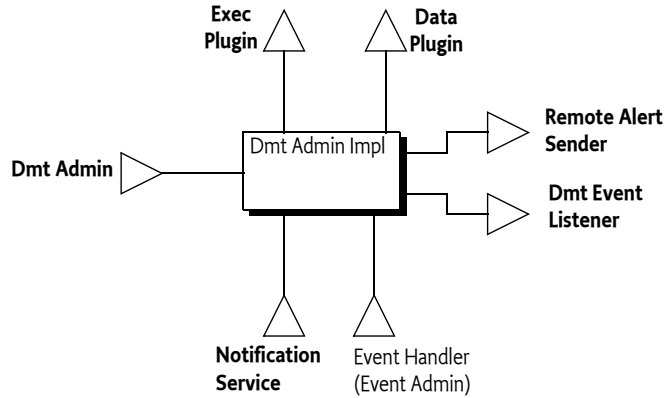

The entities used in the Dmt Admin operations and notifications are depicted in Figure 117.2.

Figure 117.2 Using Dmt Admin service, org.osgi.service.dmt and org.osgi.service.dmt.notification.\* packages

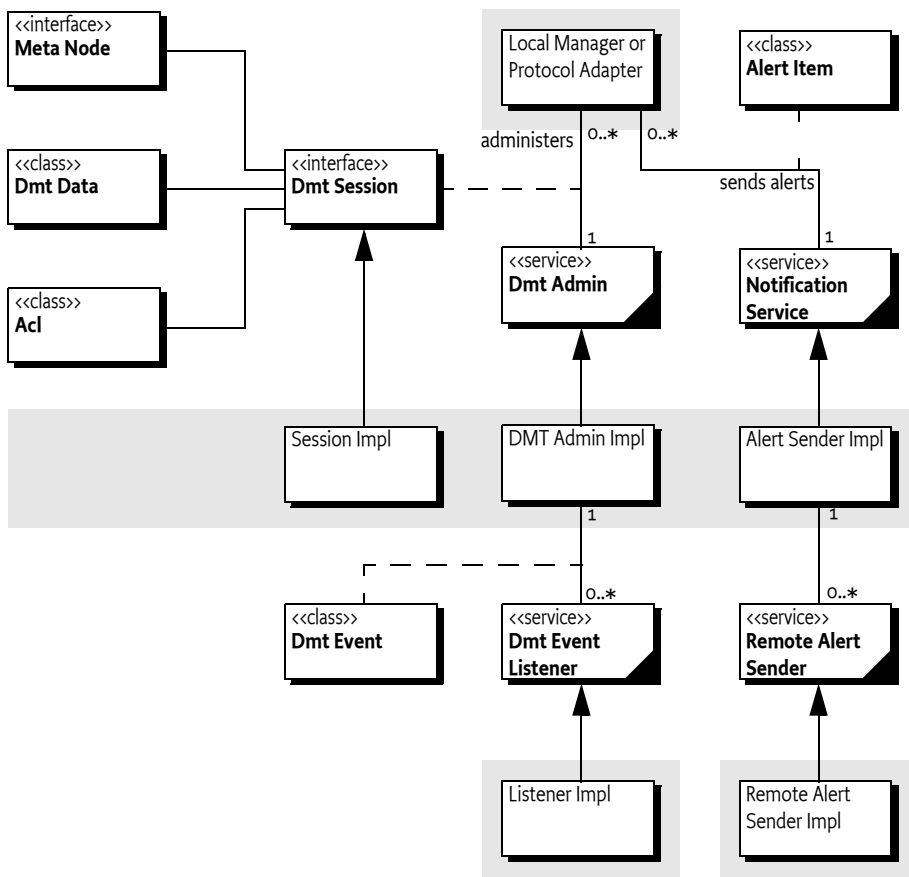

Extending the Dmt Admin service with Plugins is depicted in Figure 117.3.

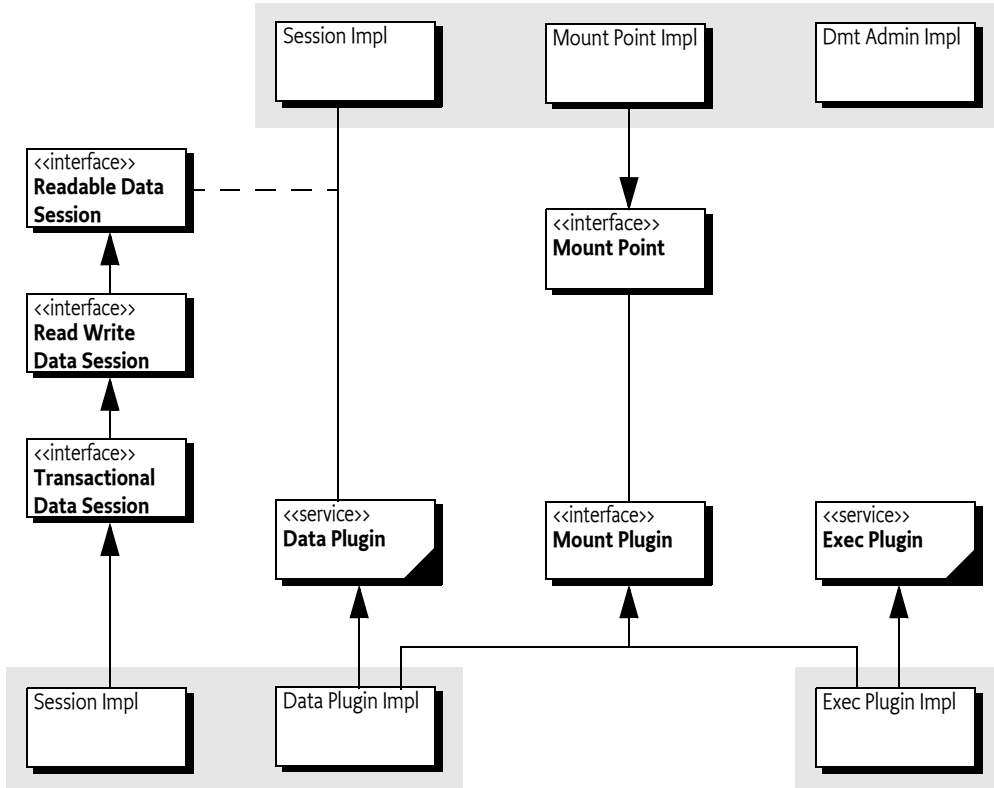
Figure 117.3 Extending the Dmt Admin service, *org.osgi.service.dmt.spi* package

## 117.2 The Device Management Model

The standard-based features of the DMT model are:

- The Device Management Tree consists of *interior* nodes and *leaf* nodes. Interior nodes can have children and leaf nodes have primitive values.
- All nodes have a set of properties: Name, Title, Format, ACL, Version, Size, Type, Value, and TimeStamp.
- The storage of the nodes is undefined. Nodes typically map to peripheral registers, settings, configuration, databases, etc.
- A node's name must be unique among its siblings.
- Nodes can have Access Control Lists (ACLs), associating operations allowed on those nodes with a particular principal.
- Nodes can have Meta Nodes that describe actual nodes and their siblings.
- Base value types (called *formats* in the standard) are
  - integer
  - long
  - string
  - boolean
  - binary data (multiple types)
  - datetime
  - time

- float
- XML fragments
- Leaf nodes in the tree can have default values specified in the meta node.
- Meta Nodes define allowed access operations (Get, Add, Replace, Delete and Exec)

Figure 117.4 Device Management Tree example

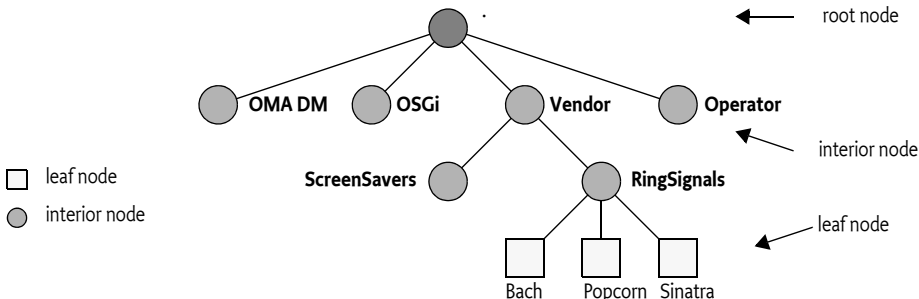

### 117.2.1 Tree Terminology

In the following sections, the DMT is discussed frequently. Thus, well-defined terms for all the concepts that the DMT introduces are needed. The different terms are shown in Figure 117.5.

Figure 117.5 DMT naming, relative to node F

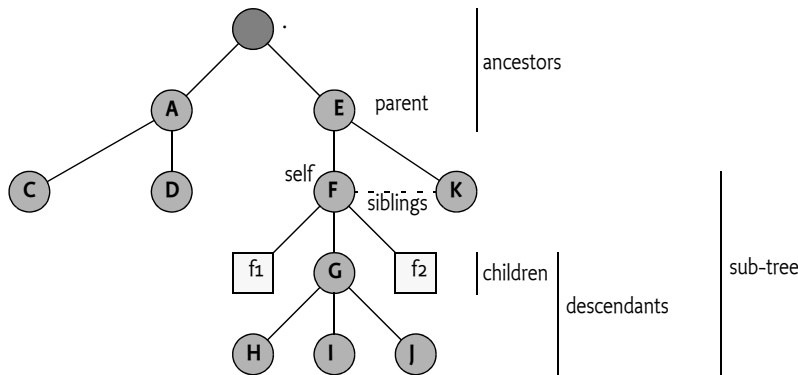

All terms are defined relative to node F. For this node, the terminology is as follows:

- *URI* - The path consisting of node names that uniquely defines a node, see *The DMT Addressing URI* on page 483.
- *ancestors* - All nodes that are above the given node ordered in proximity. The closest node must be first in the list. In the example, this list is [./E, .]
- *parent* - The first ancestor, in this example this is ./E.
- *children* - A list of nodes that are directly beneath the given node without any preferred ordering. For node F this list is { ./E/F/f1, ./E/F/f2, ./E/F/G }.
- *siblings* - An unordered list of nodes that have the same parent. All siblings must have different names. For F, this is { ./E/K }
- *descendants* - A list of all nodes below the given node. For F this is { ./E/F/f1, ./E/F/G, ./E/F/f2, ./E/F/G/H, ./E/F/G/I, ./E/F/G/J }
- *sub-tree* - The given node plus the list of all descendants. For node F this is { ./E/F, ./E/F/f1, ./E/F/G, ./E/F/f2, ./E/F/G/H, ./E/F/G/I, ./E/F/G/J }

- *overlap* - Two given URIs overlap if they share any node in their sub-trees. In the example, the sub-tree *./E/F* and *./E/F/G* overlap.
- *data root URI* - A URI which represents the root of a Data Plugin.
- *exec root URI* - A URI which represents the root of an Exec Plugin.
- *Parent Plugin* - A Plugin A is a Parent Plugin of Plugin B if B's root is in A's sub-tree, this requires a Parent Plugin to at least have one mount point.
- *Child Plugin* - A Plugin A is a Child Plugin of Plugin B if A's root is in B's sub-tree.
- *Scaffold Node* - An ancestor node of a Plugin that is managed by the Dmt Admin service to ensure that all nodes are discoverable by traversing from the root.

### 117.2.2 Actors

There are two typical users of the Dmt Admin service:

- *Remote manager* - The typical client of the Dmt Admin service is a *Protocol Adapter*. A management server external to the device can issue DMT operations over some management protocol. The protocol to be used is not specified by this specification. For example, OMA DM, TR-069, or others could be used. The protocol operations reach the Framework through the Protocol Adapter, which forwards the calls to the Dmt Admin service in a session. Protocol Adapters should authenticate the remote manager and set the principal in the session. This association will make the Dmt Admin service enforce the ACLs. This requires that the principal is equal to the server name.

The Dmt Admin service provides a facility to send notifications to the remote manager with the Notification Service.

- *Local Manager* - A bundle which uses the Dmt Admin service to operate on the DMT: for example, a GUI application that allows the end user to change settings through the DMT.

Although it is possible to manage some aspects of the system through the DMT, it can be easier for such applications to directly use the services that underlie the DMT; many of the management features available through the DMT are also available as services. These services shield the callers from the underlying details of the abstract, and sometimes hard to use DMT structure. As an example, it is more straightforward to use the Monitor Admin service than to operate upon the monitoring sub-tree. The local management application might listen to Dmt Events if it is interested in updates in the tree made by other entities, however, these events do not necessarily reflect the accurate state of the underlying services.

Figure 117.6 Actors

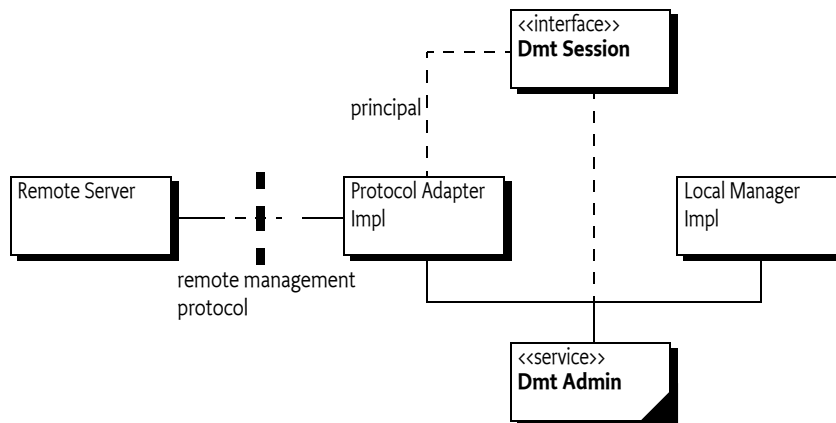

## 117.3 The DMT Admin Service

The Dmt Admin service operates on the Device Management Tree of an OSGi-based device. The Dmt Admin API is loosely modeled after the OMA DM protocol: the operations for Get, Replace, Add, Delete and Exec are directly available. The Dmt Admin is a singleton service.

Access to the DMT is session-based to allow for locking and transactionality. The sessions are, in principle, concurrent, but implementations that queue sessions can be compliant. The client indicates to the Dmt Admin service what kind of session is needed:

- *Exclusive Update Session* - Two or more updating sessions cannot access the same part of the tree simultaneously. An updating session must acquire an exclusive lock on the sub-tree which blocks the creation of other sessions that want to operate on an overlapping sub-tree.
- *Multiple Readers Session* - Any number of read-only sessions can run concurrently, but ongoing read-only sessions must block the creation of an updating session on an overlapping sub-tree.
- *Atomic Session* - An atomic session is the same as an exclusive update session, except that the session can be rolled back at any moment, undoing all changes made so far in the session. The participants must accept the outcome: rollback or commit. There is no prepare phase. The lack of full two phase commit can lead to error situations which are described later in this document; see *Plugins and Transactions* on page 496.

Although the DMT represents a persistent data store with transactional access and without size limitations, the notion of the DMT should not be confused with a general purpose database. The intended purpose of the DMT is to provide a *dynamic view* of the management state of the device; the DMT model and the Dmt Admin service are designed for this purpose.

## 117.4 Manipulating the DMT

### 117.4.1 The DMT Addressing URI

The OMA DM limits URIs to the definition of a URI in [8] *RFC 2396 Uniform Resource Identifiers (URI): Generic Syntax*. The `Uri` utility classes handles nearly all escaping issues with a number of static methods. All URIs in any of the API methods can use the full Unicode character set. For example, the following URIs as used in Java code are valid URIs for the Dmt Admin service.

```
". /ACME © 2000/A/x"
". /ACME/Address/Street/9C, Avenue St. Drézéry"
```

This strategy has a number of consequences.

- A solidus ('/' \u002F) collides with the use of the solidus as separator of the node names. Solidi must therefore be escaped using a reverse solidus ('\ ' \u005C). The reverse solidus must be escaped with a double reverse solidus sequence. The Dmt Admin service must ignore a reverse solidus when it is not followed by a solidus or reverse solidus. The solidus and reverse solidus must not be escaped using the %oo like escaping defined for URIs. For example, a node that has the name of a MIME type could look like:

```
./OSGi/mime/application\png
```

In Java, a reverse solidus must be escaped as well, therefore requiring double reverse solidi:

```
String a = ". /OSGi/mime/application\\png";
```

A literal reverse solidus would therefore require 4 reverse solidi in a Java string.

- The length of a node name is defined to be the length of the byte array that results from UTF-8 encoding a string.

The `Uri` class provides an `encode(String)` method to escape a string and a `decode(String)` method to unescape a string. Though in general the Dmt Admin service implementations should not impose unnecessary constraints on the node name length, it is possible that an implementation runs out of space. In that case it must throw a `DmtException URI_TOO_LONG`.

Nodes are addressed by presenting a *relative* or *absolute URI* for the requested node. The URI is defined with the following grammar:

```
uri           ::= relative-uri | absolute-uri
absolute-uri  ::= './' relative-uri
relative-uri  ::= segment ( '/' segment ) *
segment       ::= (- [ '/' ] ) *
```

The `Uri.isAbsoluteUri(String)` method makes it simple to find out if a URI is relative or absolute. Relative URIs require a base URI that is for example provided by the session, see *Locking and Sessions* on page 484.

Each node name is appended to the previous ones using a solidus (`'/' \u002F`) as the separating character. The first node of an absolute URI must be the full stop (`'.' \u002E`). For example, to access the Bach leaf node in the RingTones interior node from Figure 117.4 on page 481, the URI must be:

```
./Vendor/RingSignals/Bach
```

The URI must be given with the root of the management tree as the starting point. URIs used in the DMT must be treated and interpreted as *case-sensitive*. I.e., `./Vendor` and `./vendor` designate two different nodes. The following mandatory restrictions on URI syntax are intended to simplify the parsing of URIs.

The full stop has no special meaning in a node name. That is, sequences like `..` do not imply parent node. The `isValidUri(String)` method verifies that a URI fulfills all its obligations and is valid.

## 117.4.2 Locking and Sessions

The Dmt Admin service is the main entry point into the DMT, its usage is to create sessions. A simple example is getting a session on a specific sub-tree. Such a session can be created with the `getSession(String)` method. This method creates an updating session with an exclusive lock on the given sub-tree. The given sub-tree can be a single leaf node, if so desired.

Each session has an ID associated with it which is unique to the machine and is never reused. This id is always greater than 0. The value -1 is reserved as place holder to indicate a situation has no session associated with it, for example an event generated from an underlying service. The URI argument addresses the sub-tree root. If null, it addresses the root of the DMT. All nodes can be reached from the root, so specifying a session root node is not strictly necessary but it permits certain optimizations in the implementations.

If the default exclusive locking mode of a session is not adequate, it is possible to specify the locking mode with the `getSession(String,int)` and `getSession(String,String,int)` method. These methods supports the following locking modes:

- `LOCK_TYPE_SHARED` - Creates a *shared session*. It is limited to read-only access to the given sub-tree, which means that multiple sessions are allowed to read the given sub-tree at the same time.
- `LOCK_TYPE_EXCLUSIVE` - Creates an *exclusive session*. The lock guarantees full read-write access to the tree. Such sessions, however, cannot share their sub-tree with any other session. This type of lock requires that the underlying implementation supports Read Write Data Sessions.
- `LOCK_TYPE_ATOMIC` - Creates an *atomic session* with an exclusive lock on the sub-tree, but with added transactionality. Operations on such a session must either succeed together or fail together.



er. This type of lock requires that the underlying implementation supports Transactional Data Sessions. If the Dmt Admin service does not support transactions, then it must throw a Dmt Exception with the `FEATURE_NOT_SUPPORTED` code. If the session accesses data plugins that are not transactional in write mode, then the Dmt Admin service must throw a Dmt Exception with the `TRANSACTION_ERROR` code. That is, data plugins can participate in a atomic sessions as long as they only perform read operations.

The Dmt Admin service must lock the sub-tree in the requested mode before any operations are performed. If the requested sub-tree is not accessible, the `getSession(String,int)`, `getSession(String,String,int)`, or `getSession(String)` method must block until the sub-tree becomes available. The implementation can decide after an implementation-dependent period to throw a Dmt Exception with the `SESSION_CREATION_TIMEOUT` code.

As a simplification, the Dmt Admin service is allowed to lock the entire tree irrespective of the given sub-tree. For performance reasons, implementations should provide more fine-grained locking when possible.

Persisting the changes of a session works differently for exclusive and atomic sessions. Changes to the sub-tree in an atomic session are not persisted until the `commit()` or `close()` method of the session is called. Changes since the last transaction point can be rolled back with the `rollback()` method.

The `commit()` and `rollback()` methods can be called multiple times in a session; they do not close the session. The open, `commit()`, and `rollback()` methods all establish a *transaction point*. The rollback operation cannot roll back further than the last transaction point.

Once a fatal error is encountered (as defined by the `DmtException.isFatal()` method), all successful changes must be rolled back automatically to the last transaction point. Non-fatal errors do not rollback the session. Any error/exception in the commit or rollback methods invalidates and closes the session. This can happen if, for example, the mapping state of a plugin changes that has its plugin root inside the session's sub-tree.

Changes in an exclusive session are persisted immediately after each separate operation. Errors do not roll back any changes made in such a session.

Due to locking and transactional behavior, a session of any type must be closed once it is no longer used. Locks must always be released, even if the `close()` method throws an exception.

Once a session is closed no further operations are allowed and manipulation methods must throw a Dmt Illegal State Exception when called. Certain information methods like for example `getState()` and `getRootUri()` can still be called for logging or diagnostic purposes. This is documented with the Dmt Session methods.

The `close()` or `commit()` method can be expected to fail even if all or some of the individual operations were successful. This failure can occur due to multi-node constraints defined by a specific implementation. The details of how an implementation specifies such constraints is outside the scope of this specification.

Events in an atomic session must only be sent at commit time.

### 117.4.3 Associating a Principal

Protocol Adapters must use the `getSession(String,String,int)` method which features the principal as the first parameter. The principal identifies the external entity on whose behalf the session is created. This server identification string is determined during the authentication process in a way specific to the management protocol.

For example, the identity of the OMA DM server can be established during the handshake between the OMA DM agent and the server. In the simpler case of OMA CP protocol, which is a one-way protocol based on WAP Push, the identity of the principal can be a fixed value.

### 117.4.4 Relative Addressing

All DMT operation methods are found on the session object. Most of these methods accept a *relative* or *absolute* URI as their first parameter: for example, the method `isLeafNode(String)`. This URI is absolute or relative to the sub-tree with which the session is associated. For example, if the session is opened on:

```
./Vendor
```

then the following URIs address the Bach ring tone:

```
RingTones/Bach
./Vendor/RingTones/Bach
```

Opening the session with a null URI is identical to opening the session at the root. But the absolute URI can be used to address the Bach ring tone as well as a relative URI.

```
./Vendor/RingTones/Bach
Vendor/RingTones/Bach
```

If the URI specified does not correspond to a legitimate node in the tree, a Dmt Exception must be thrown. The only exception to this rule is the `isNodeUri(String)` method that can verify if a node is actually valid. The `getMetaNode(String)` method must accept URIs to non-existing nodes if an applicable meta node is available; otherwise it must also throw a Dmt Exception.

### 117.4.5 Creating Nodes

The methods that create interior nodes are:

- `createInteriorNode(String)` - Create a new interior node using the default meta data. If the principal does not have Replace access rights on the parent of the new node then the session must automatically set the ACL of the new node so that the creating server has Add, Delete and Replace rights on the new node.
- `createInteriorNode(String,String)` - Create a new interior node. The meta data for this new node is identified by the second argument, which is a URI *identifying* an OMA DM Device Description Framework (DDF) file, this does not have to be a valid location. It uses a format like `org.osgi/1.0/LogManagementObject`. This meta node must be consistent with any meta information from the parent node.
- `createLeafNode(String)` - Create a new leaf node with a default value.
- `createLeafNode(String,DmtData)` - Create a leaf node and assign a value to the leaf-node.
- `createLeafNode(String,DmtData,String)` - Create a leaf node and assign a value for the node. The last argument is the MIME type, which can be null.

For a node to be created, the following conditions must be fulfilled:

- The URI of the new node has to be a valid URI.
- The principal of the Dmt Session, if present, must have ACL Add permission to add the node to the parent. Otherwise, the caller must have the necessary permission.
- All constraints of the meta node must be verified, including value constraints, name constraints, type constraints, and MIME type constraints. If any of the constraints fail, a Dmt Exception must be thrown with an appropriate code.

### 117.4.6 Node Properties

A DMT node has a number of runtime properties that can be set through the session object. These properties are:

- *Title* - (String) A human readable title for the object. The title is distinct from the node name. The title can be set with `setNodeTitle(String,String)` and read with `getNodeTitle(String)`. This spec-

ification does not define how this information is localized. This property is optional depending on the implementation that handles the node.

- *Type* - (String) The MIME type, as defined in [9] *MIME Media Types*, of the node's value when it is a leaf node. The type of an interior node is a string identifying a DDF type. These types can be set with `setNodeType(String,String)` and read with `getNodeType(String)`.
- *Version* - (int) Version number, which must start at 0, incremented after every modification (for both a leaf and an interior node) modulo 0x10000. Changes to the value or any of the properties (including ACLs), or adding/deleting nodes, are considered changes. The `getNodeVersion(String)` method returns this version; the value is read-only. In certain cases, the underlying data structure does not support change notifications or makes it difficult to support versions. This property is optional depending on the node's implementation.
- *Size* - (int) The size measured in bytes is read-only and can be read with `getNodeSize(String)`. Not all nodes can accurately provide this information.
- *Time Stamp* - (Date) Time of the last change in version. The `getNodeTimestamp(String)` returns the time stamp. The value is read only. This property is optional depending on the node's implementation.
- *ACL* - The Access Control List for this and descendant nodes. The property can be set with `setNodeAcl(String,Acl)` and obtained with `getNodeAcl(String)`.

If a plugin that does not implement an optional property is accessed, a Dmt Exception with the code `FEATURE_NOT_SUPPORTED` must be thrown.

### 117.4.7 Setting and Getting Data

Values are represented as DmtData objects, which are immutable. They are acquired with the `getNodeValue(String)` method and set with the `setNodeValue(String,DmtData)` method.

DmtData objects are dynamically typed by an integer enumeration. In OMA DM, this integer is called the *format* of the data value. The format of the DmtData class is similar to the type of a variable in a programming language, but the word *format* is used here. The available data formats are listed in the following table.

Table 117.1 Data Formats

Format Type	Java Type	Format Name	Constructor	Get	Description
FORMAT_BASE64	byte[]	base64	DmtData(byte[],boolean)	getBase64()	Binary type that must be encoded with base 64, see [10] <i>RFC 3548 The Base16, Base32, and Base64 Data Encodings</i> .
FORMAT_BINARY	byte[]	binary	DmtData(byte[]) DmtData(byte[],boolean)	getBinary()	A byte array. The DmtData object is created with the constructor. The byte array can only be acquired with the method.
FORMAT_BOOLEAN	boolean	boolean	DmtData(boolean)	getBoolean()	Boolean. There are two constants for this type: <ul style="list-style-type: none"> <li>• FALSE_VALUE</li> <li>• TRUE_VALUE</li> </ul>
FORMAT_DATE	String	date	DmtData(String,int)	getString() getDate()	A Date (no time). Syntax defined in [13] <i>XML Schema Part 2: Datatypes Second Edition</i> as the date type.

Format Type	Java Type	Format Name	Constructor	Get	Description
FORMAT_DATE_TIME	String	date-Time	DmtData(Date)	getDateTime()	A Date object representing a point in time.
FORMAT_FLOAT	float	float	DmtData(float)	getFloat()	Float
FORMAT_INTEGER	int	integer	DmtData(int)	getInt()	Integer
FORMAT_LONG	long	long	DmtData(long)	getLong()	Long
FORMAT_NODE	Object	NODE	DmtData(Object)	getNode()	A DmtData object can have a format of <a href="#">FORMAT_NODE</a> . This value is returned from a MetaNode <a href="#">getFormat()</a> method if the node is an interior node or for a data value when the Plugin supports complex values.
FORMAT_NULL					No valid data is available. DmtData objects with this format cannot be constructed; the only instance is the DmtData <a href="#">NULL_VALUE</a> constant.
FORMAT_RAW_BINARY	byte[]	<custom>	DmtData(String,byte[])	getRawBinary()	A raw binary format is always created with a format name. This format name allows the creator to define a proprietary format. The format name is available from the <a href="#">getFormatName()</a> method, which has predefined values for the standard formats.
FORMAT_RAW_STRING	String	<custom>	DmtData(String,String)	getRawString()	A raw string format is always created with a format name. This format name allows the creator to define a proprietary format. The format name is available from the <a href="#">getFormatName()</a> method, which has predefined values for the standard formats.
FORMAT_STRING	String	string	DmtData(String)	getString()	String
FORMAT_TIME	String	time	DmtData(String,int)	getString()	Time of Day. Syntax defined in [13] <i>XML Schema Part 2: Datatypes Second Edition</i> as the time type.

Format Type	Java Type	Format Name	Constructor	Get	Description
FORMAT_XML	String	xml	DmtData(String,int)	getXml()	A string containing an XML fragment. It can be obtained with. The validity of the XML must not be verified by the Dmt Admin service.

### 117.4.8 Complex Values

The OMA DM model prescribes that only leaf nodes have primitive values. This model maps very well to remote managers. However, when a manager is written in Java and uses the Dmt Admin API to access the tree, there are often unnecessary conversions from a complex object, to leaf nodes, and back to a complex object. For example, an interior node could hold the current GPS position as an OSGi Position object, which consists of a longitude, latitude, altitude, speed, and direction. All these objects are Measurement objects which consist of value, error, and unit. Reading such a Position object through its leaf nodes only to make a new Position object is wasting resources. It is therefore that the Dmt Admin service also supports *complex values* as a supplementary facility.

If a complex value is used then the leaves must also be accessible and represent the same semantics as the complex value. A manager unaware of complex values must work correctly by only using the leaf nodes. Setting or getting the complex value of an interior node must be identical to setting or getting the leaf nodes.

Accessing a complex value requires Get access to the node and all its descendants. Setting a complex value requires Replace access to the interior node. Replacing a complex value must only generate a single Replace event.

Trying to set or get a complex value on an interior node that does not support complex values must throw a Dmt Exception with the code `FEATURE_NOT_SUPPORTED`.

### 117.4.9 Nodes and Types

The node's type can be set with the `setNodeType(String,String)` method and acquired with `getNodeType(String)`. The namespaces for the types differ for interior and leaf nodes. A leaf node is typed with a MIME type and an interior node is typed with a DDF Document URI. However, in both cases the Dmt Admin service must not verify the syntax of the type name.

The `createLeafNode(String,DmtData,String)` method takes a MIME type as last argument that will type the leaf node. The MIME type reflects how the data of the node should be *interpreted*. For example, it is possible to store a GIF and a JPEG image in a DmtData object with a `FORMAT_BINARY` format. Both the GIF and the JPEG object share the same *format*, but will have MIME types of `image/jpg` and `image/gif` respectively. The Meta Node provides a list of possible MIME types.

The `createInteriorNode(String,String)` method takes a DDF Document URI as the last argument that will type the interior node. This specification defines the DDF Document URIs listed in the following table for interior nodes that have a particular meaning in this specification.

Table 117.2 Standard Interior Node Types

Interior Node Type	Description
<code>DDF_SCAFFOLD</code>	Scaffold nodes are automatically generated nodes by the Dmt Admin service to provide the children node names so that Plugins are reachable from the root. See <i>Scaffold Nodes</i> on page 497.
<code>DDF_MAP</code>	MAP nodes define a key -> value mapping construct using the node name (key) and the node value (value). See <i>MAP Nodes</i> on page 525.

Interior Node Type	Description
DDF_LIST	LIST nodes use the node name to maintain an index in a list. See <i>LIST Nodes</i> on page 523.

### 117.4.10 Deleting Nodes

The `deleteNode(String)` method on the session represents the Delete operation. It deletes the sub-tree of that node. This method is applicable to both leaf and interior nodes. Nodes can be deleted by the Dmt Admin service in any order. The root node of the session cannot be deleted.

For example, given Figure 117.7, deleting node P must delete the nodes `./P`, `./P/M`, `./P/M/X`, `./P/M/n2` and `./P/M/n3` in any order.

Figure 117.7

DMT node and deletion

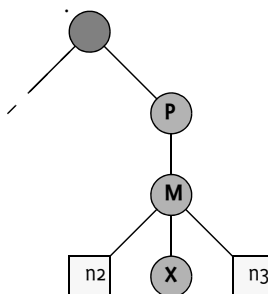

### 117.4.11 Copying Nodes

The `copy(String,String,boolean)` method on the `DmtSession` object represents the Copy operation. A node is completely copied to a new URI. It can be specified with a boolean if the whole sub-tree (true) or just the indicated node is copied.

The ACLs must not be copied; the new access rights must be the same as if the caller had created the new nodes individually. This restriction means that the copied nodes inherit the access rights from the parent of the destination node, unless the calling principal does not have Replace rights for the parent. See *Creating Nodes* on page 486 for details.

### 117.4.12 Renaming Nodes

The `renameNode(String,String)` method on the `DmtSession` object represents the Rename operation, which replaces the node name. It requires permission for the Replace operation. The root node for the current session can not be renamed.

### 117.4.13 Execute

The `execute(String,String)` and `execute(String,String,String)` methods can *execute* a node. Executing a node is intended to be used when a problem is hard to model as a set of leaf nodes. This can be related to synchronization issues or data manipulation. The execute methods can provide a correlator for a notification and an opaque string that is forwarded to the implementer of the node.

Execute operations can not take place in a read only session because simultaneous execution could make conflicting changes to the tree.

### 117.4.14 Closing

When all the changes have been made, the session must be closed by calling the `close()` method on the session. The Dmt Admin service must then finalize, clean up, and release any locks. For atomic sessions, the Dmt Admin service must automatically commit any changes that were made since the last transaction point.

A session times out and is invalidated after an extended period of inactivity. The exact length of this period is not specified, but is recommended to be at least 1 minute and at most 24 hours. All methods of an invalidated session must throw an `Dmt Illegal State Exception` after the session is invalidated.

A session's state is one of the following: `STATE_CLOSED`, `STATE_INVALID` or `STATE_OPEN`, as can be queried by the `getState()` call. The invalid state is reached either after a fatal error case is encountered or after the session is timed out. When an atomic session is invalidated, it is automatically rolled back to the last transaction point of the session.

## 117.5 Meta Data

The `getMetaNode(String)` method returns a `MetaNode` object for a given URI. This node is called the *meta node*. A meta node provides information about nodes.

Any node can optionally have a meta node associated with it. The one or more nodes that are described by the meta nodes are called the meta node's *related instances*. A meta node can describe a singleton-related instance, or it can describe all the children of a given parent if it is a *multi-node*. That is to say, meta nodes can exist without an actual instance being present. In order to retrieve the meta node of a multi-node any name can be used.

For example, if a new ring tone, Grieg, was created in Figure 117.8 it would be possible to get the Meta Node for `./Vendor/RingSignals/Grieg` before the node was created. This is usually the case for multi nodes. The model is depicted in Figure 117.8.

Figure 117.8 Nodes and meta nodes

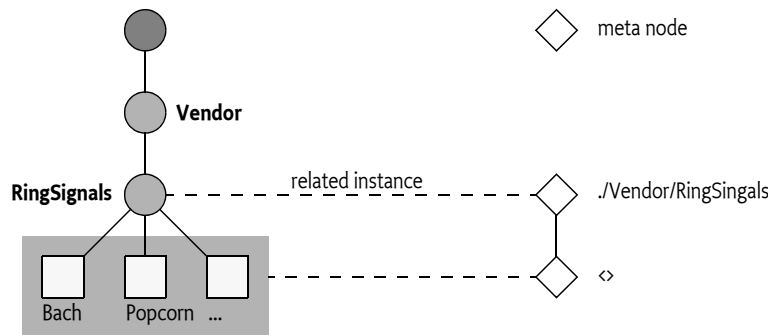

A URI is generally associated with the same Meta Node. The `getMetaNode(String)` should return the same meta node for the same URI except in the case of *Scaffold Nodes* on page 497. As the ownership of scaffold nodes can change from the Dmt Admin service to the Parent Plugin service, or from a Parent Plugin to a Child Plugin, the Meta Node can change as well.

The last segment of the URI to get a Meta Node can be any valid node name, for example, instead of `Grieg` it would have been possible to retrieve the same Meta Node with the name `./Vendor/RingSignals/o`, `./Vendor/RingSignals/anyName`, `./Vendor/RingSignals/<>`, etc.

The actual meta data can come from two sources:

- *Dmt Admin* - Each Dmt Admin service likely has a private meta data repository. This meta data is placed in the device in a proprietary way.
- *Plugins* - Plugins can carry meta nodes and provide these to the Dmt Admin service by implementing the `getMetaNode(String[])` method. If a plugin returns a non-null value, the Dmt Admin service must use that value, possibly complemented by its own metadata for elements not provided by the plugin.

The MetaNode interface supports methods to retrieve read-only meta data. The following sections describes this meta-data in more detail.

### 117.5.1 Operations

The `can(int)` method provide information as to whether the associated node can perform the given operation. This information is only about the capability; it can still be restricted in runtime by ACLs and permissions.

For example, if the `can(MetaNode.CMD_EXECUTE)` method returns true, the target object supports the Execute operation. That is, calling the `execute(String,String)` method with the target URI is possible.

The `can(int)` method can take the following constants as parameters:

- `CMD_ADD`
- `CMD_DELETE`
- `CMD_EXECUTE`
- `CMD_GET`
- `CMD_REPLACE`

For example:

```
void foo( DmtSession session, String nodeUri) {
    MetaNode meta = session.getMetaNode(nodeUri);
    if ( meta !=null && meta.can(MetaNode.CMD_EXECUTE) )
        session.execute(nodeUri, "foo" );
}
```

### 117.5.2 Scope

The scope is part of the meta information of a node. It provides information about what the life cycle role is of the node. The `getScope()` method on the Meta Node provides this information. The value of the scope can be one of the following:

- **DYNAMIC** - Dynamic nodes are intended to be created and deleted by a management system or an other controlling source. This does not imply that it actually is possible to add new nodes and delete nodes, the actions can still allow or deny this. However, in principle nodes that can be added or deleted have the **DYNAMIC** scope. The LIST and MAP nodes, see *OSGi Object Modeling* on page 519, always have **DYNAMIC** scope.
- **PERMANENT** - Permanent nodes represent an entity in the system. This can be a network interface, a device description, etc. Permanent nodes in general map to an object in an object oriented language. Despite their name, **PERMANENT** nodes can appear and disappear, for example the plugging in of a USB device might create a new **PERMANENT** node. Generally, the Plugin roots map to **PERMANENT** nodes.
- **AUTOMATIC** - Automatic nodes map in general to nodes that are closely tied to the parent. They are similar to fields of an object in an object oriented language. They cannot be deleted or added.

For example, a node representing the Battery can never be deleted because it is an intrinsic part of the device; it will therefore be **PERMANENT**. The Level and number of ChargeCycle nodes will be **AUTOMATIC**. A new ring tone is dynamically created by a manager and is therefore **DYNAMIC**.

### 117.5.3 Description and Default

- `getDescription()` - (String) A description of the node. Descriptions can be used in dialogs with end users: for example, a GUI application that allows the user to set the value of a node. Localization of these values is not defined.



- `getDefault()` - (DmtData) A default data value.

#### 117.5.4 Validation

The validation information allows the runtime system to verify constraints on the values; it also allows user interfaces to provide guidance.

A node does not have to exist in the DMT in order to have meta data associated with it. Nodes may exist that have only partial meta data, or no metadata, associated with them. For each type of meta-data, the default value to assume when it is omitted is described in [MetaNode](#).

#### 117.5.5 Data Types

A leaf node can be constrained to a certain format and one of a set of MIME types.

- `getFormat()` - (int) The required type. This type is a logical OR of the supported formats.
- `getRawFormatNames()` - Return an array of possible raw format names. This is only applicable when the `getFormat()` returns the `FORMAT_RAW_BINARY` or `FORMAT_RAW_STRING` formats. The method must return null otherwise.
- `getMimeTypes()` - (String[]) A list of MIME types for leaf nodes or DDF types for interior nodes. The Dmt Admin service must verify that the actual type of the node is part of this set.

#### 117.5.6 Cardinality

A meta node can constrain the number of *siblings* (i.e., not the number of children) of an interior or leaf node. This constraint can be used to verify that a node must not be deleted, because there should be at least one node left on that level (`isZeroOccurrenceAllowed()`), or to verify that a node cannot be created, because there are already too many siblings (`getMaxOccurrence()`).

If the cardinality of a meta node is more than one, all siblings must share the same meta node to prevent an invalid situation. For example, if a node has two children that are described by different meta nodes, and any of the meta nodes has a cardinality > 1, that situation is invalid.

For example, the `./Vendor/RingSignals/<>` meta node (where `<>` stands for any name) could specify that there should be between 0 and 12 ring signals.

- `getMaxOccurrence()` - (int) A value greater than 0 that specifies the maximum number of instances for this node.
- `isZeroOccurrenceAllowed()` - (boolean) Returns true if zero instances are allowed. If not, the last instance must not be deleted.

#### 117.5.7 Matching

The following methods provide validation capabilities for leaf nodes.

- `isValidValue(DmtData)` - (DmtData) Verify that the given value is valid for this meta node.
- `getValidValues()` - (DmtData[]) A set of possible values for a node, or null otherwise. This can for example be used to give a user a set of options to choose from.

#### 117.5.8 Numeric Ranges

Numeric leaf nodes (format must be `FORMAT_INTEGER`, `FORMAT_LONG`, or `FORMAT_FLOAT`) can be checked for a minimum and maximum value.

Minimum and maximum values are inclusive. That is, the range is [`getMin()`,`getMax()`]. For example, if the maximum value is 5 and the minimum value is -5, then the range is [-5,5]. This means that valid values are -5, -4, -3, -2... 4, 5.

- `getMax()` - (double) The value of the node must be less than or equal to this maximum value.

- `getMin()` - (double) The value of the node must be greater than or equal to this minimum value.

If no meta data is provided for the minimum and maximum values, the meta node must return the `Double.MIN_VALUE`, and `Double.MAX_VALUE` respectively.

### 117.5.9 Name Validation

The meta node provides the following name validation facilities for both leaf and interior nodes:

- `isValidName(String)` - (String) Verifies that the given name matches the rules for this meta node.
- `getValidNames()` - (String[]) An array of possible names. A valid name for this node must appear in this list.

### 117.5.10 User Extensions

The Meta Node provides an extension mechanism; each meta node can be associated with a number of properties. These properties are then interpreted in a proprietary way. The following methods are used for user extensions:

- `getExtensionPropertyKeys()` - Returns an array of key names that can be provided by this meta node.
- `getExtensionProperty(String)` - Returns the value of an extension property.

For example, a manufacturer could use a regular expression to validate the node names with the `isValidName(String)` method. In a web based user interface it is interesting to provide validity checking in the browser, however, in such a case the regular expression string is required. This string could then be provided as a user extension under the key `x-acme-regex-javascript`.

## 117.6 Plugins

The Plugins take the responsibility of handling DMT operations within certain sub-trees of the DMT. It is the responsibility of the Dmt Admin service to forward the operation requests to the appropriate plugin. The only exceptions are the ACL manipulation commands. ACLs must be enforced by the Dmt Admin service and never by the plugin. The model is depicted in Figure 117.9.

Figure 117.9 Device Management Tree example

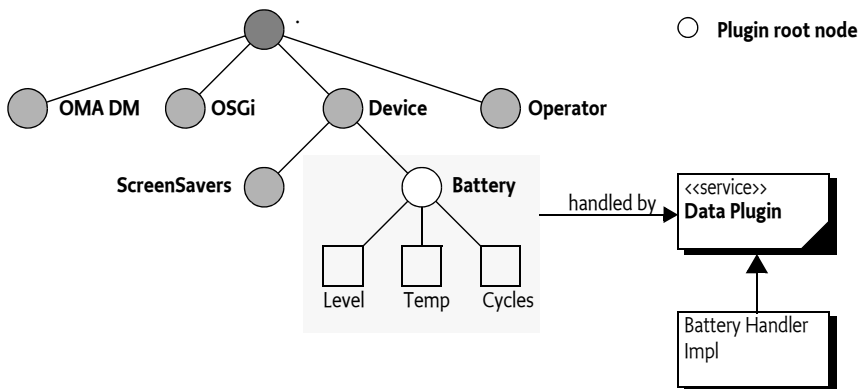

Plugins are OSGi services. The Dmt Admin service must dynamically map and unmap the plugins, acting as node handler, as they are registered and unregistered. Service properties are used to specify the sub-tree that the plugin can manage as well as mount points that it provides to *Child Plugins*; plugins that manage part of the Plugin's sub-tree.

For example, a plugin related to Configuration Admin handles the sub-tree which stores configuration data. This sub-tree could start at `./OSGi/Configuration`. When the client wants to add a new configuration object to the DMT, it must issue an `Add` operation to the `./OSGi/Configuration` node. The Dmt Admin service then forwards this operation to the configuration plugin. The plugin maps the request to one or more method calls on the Configuration Admin service. Such a plugin can be a simple proxy to the Configuration Admin service, so it can provide a DMT view of the configuration data store.

There are two types of Dmt plugins: *data plugins* and *exec plugins*. A data plugin is responsible for handling the sub-tree retrieval, addition and deletion operations, and handling of meta data, while an exec plugin handles a node execution operation.

### 117.6.1 Data Sessions

Data Plugins must participate in the Dmt Admin service sessions. A Data Plugin provider must therefore register a Data Plugin service. Such a service can create a session for the Dmt Admin service when the given sub-tree is accessed by a Dmt Session. If the associated Dmt Session is later closed, the Data Session will also be closed. Three types of sessions provide different capabilities. Data Plugins do not have to implement all session types; if they choose not to implement a session type they can return null.

- *Readable Data Session* - Must always be supported. It provides the basic read-only access to the nodes and the `close()` method. The Dmt Admin service uses this session type when the lock mode is `LOCK_TYPE_SHARED` for the Dmt Session. Such a session is created with the plugin's `openReadOnlySession(String[],DmtSession)`, method which returns a `ReadableDataSession` object.
- *Read Write Data Session* - Extends the Readable Data Session with capabilities to modify the DMT. This is used for Dmt Sessions that are opened with `LOCK_TYPE_EXCLUSIVE`. Such a session is created with the plugin's `openReadWriteSession(String[],DmtSession)` method, which returns a `ReadWriteDataSession` object.
- *Transactional Data Session* - Extends the Read Write Data Session with commit and rollback methods so that this session can be used with transactions. It is used when the Dmt Session is opened with lock mode `LOCK_TYPE_ATOMIC`. Such a session is created with the plugin's `openAtomicSession(String[],DmtSession)` method, which returns a `TransactionalDataSession` object.

### 117.6.2 URIs and Plugins

The plugin Data Sessions do not use a simple string to identify a node as the Dmt Session does. Instead the URI parameter is a `String[]`. The members of this `String[]` are the different segments. The first node after the root is the second segment and the node name is the last segment. The different segments require escaping of the solidus (`'/' \u002F`) and reverse solidus (`'\' \u005C`).

The reason to use `String[]` objects instead of the original string is to reduce the number times that the URI is parsed. The entry `String` objects, however, are still escaped. For example, the URI `./A/B/image\jpg` gives the following `String[]`:

```
{ ".", "A", "B", "image\jpg" }
```

A plugin can assume that the path is validated and can be used directly.

### 117.6.3 Associating a sub-tree

Each plugin is associated with one or more DMT sub-trees. The top node of a sub-tree is called the *plugin root*. The plugin root is defined by a service registration property. This property is different for exec plugins and data plugins:

- `DATA_ROOT_URIS` - (String+) A sequence of *data URI*, defining a plugin root for data plugins.

- `EXEC_ROOT_URI` - (String+) A sequence of *exec URI*, defining a plugin root for exec plugins.

If the Plugin modifies these service properties then the Dmt Admin service must reflect these changes as soon as possible. The reason for the different properties is to allow a single service to register both as a Data Plugin service as well as an Exec Plugin service.

Data and Exec Plugins live in independent trees and can fully overlap. However, an Exec Plugin can only execute a node when there exists a valid node at the corresponding node in the Data tree. That is, to be able to execute a node it is necessary that `isNodeUri(String)` would return true.

For example, a data plugin can register itself in its activator to handle the sub-tree `./Dev/Battery`:

```
public void start(BundleContext context) {
    Hashtable ht = new Hashtable();
    ht.put(Constants.SERVICE_PID, "com.acme.data.plugin");
    ht.put(DataPlugin.DATA_ROOT_URI, "./Dev/Battery");
    context.registerService(
        DataPlugin.class.getName(),
        new BatteryHandler(context);
        ht );
}
```

If this activator was executed, an access to `./Dev/Battery` must be forwarded by the Dmt Admin service to this plugin via one of the data session.

#### 117.6.4 Synchronization with Dmt Admin Service

The Dmt Admin service can, in certain cases, detect that a node was changed without the plugin knowing about this change. For example, if the ACL is changed, the version and timestamp must be updated; these properties are maintained by the plugin. In these cases, the Dmt Admin service must open a `ReadableDataSession` and call `nodeChanged(String[])` method with the changed URI.

#### 117.6.5 Plugin Meta Data

Plugins can provide meta data; meta data from the Plugin must take precedence over the meta data of the Dmt Admin service. If a plugin provides meta information, the Dmt Admin service must verify that an operation is compatible with the meta data of the given node.

For example if the plugin reports in its meta data that the `./A` leaf node can only have the `text/plain` MIME type, the `createLeafNode(String)` calls must not be forwarded to the Plugin if the third argument specifies any other MIME type. If this contract between the Dmt Admin service and the plugin is violated, the plugin should throw a Dmt Exception `METADATA_MISMATCH`.

#### 117.6.6 Plugins and Transactions

For the Dmt Admin service to be transactional, transactions must be supported by the data plugins. This support is not mandatory in this specification, and therefore the Dmt Admin service has no transactional guarantees for atomicity, consistency, isolation or durability. The `DmtAdmin` interface and the `DataPlugin` (or more specifically the data session) interfaces, however, are designed to support Data Plugin services that are transactional. Exec plugins need not be transaction-aware because the `execute` method does not provide transactional semantics, although it can be executed in an atomic transaction.

Data Plugins do not have to support atomic sessions. When the Dmt Admin service creates a Transactional Data Session by calling `openAtomicSession(String[],DmtSession)` the Data Plugin is allowed to return null. In that case, the plugin does not support atomic sessions. The caller receives a Dmt Exception.

Plugins must persist any changes immediately for Read Write Data Sessions. Transactional Data Sessions must delay changes until the `commit()` method is called, which can happen multiple times

during a session. The opening of an atomic session and the `commit()` and `rollback()` methods all establish a *transaction point*. Rollback can never go further back than the last transaction point.

- `commit()` - Commit any changes that were made to the DMT but not yet persisted. This method should not throw an Exception because other Plugins already could have persisted their data and can no longer roll it back. The commit method can be called multiple times in an open session, and if so, the commit must make persistent the changes since the last transaction point.
- `rollback()` - Undo any changes made to the sub-tree since the last transaction point.
- `close()` - Clean up and release any locks. The Dmt Admin service must call the commit methods before the close method is called. A Plugin must not perform any persistency operations in the close method.

The `commit()`, `rollback()`, and `close()` plugin data session methods must all be called in reverse order of that in which Plugins joined the session.

If a Plugin throws a fatal exception during an operation, the Dmt Session must be rolled back immediately, automatically rolling back all data plugins, as well as the plugins that threw the fatal Dmt Exception. The fatality of an Exception can be checked with the Dmt Exception `isFatal()` method.

If a plugin throws a non-fatal exception in any method accessing the DMT, the current operation fails, but the session remains open for further commands. All errors due to invalid parameters (e.g. non-existing nodes, unrecognized values), all temporary errors, etc. should fall into this category.

A rollback of the transaction can take place due to any irregularity during the session. For example:

- A necessary Plugin is unregistered or unmapped
- A fatal exception is thrown while calling a plugin
- Critical data is not available
- An attempt is made to breach the security

Any Exception thrown during the course of a `commit()` or `rollback()` method call is considered fatal, because the session can be in a half-committed state and is not safe for further use. The operation in progress should be continued with the remaining Plugins to achieve a *best-effort* solution in this limited transactional model. Once all plugins have been committed or rolled back, the Dmt Admin service must throw an exception, specifying the cause exception(s) thrown by the plugin(s), and should log an error.

### 117.6.7 Side Effects

Changing a node's value will have a side effect of changing the system. A plugin can also, however, cause state changes with a get operation. Sometimes the pattern to use a get operation to perform a state changing action can be quite convenient. The get operation, however, is defined to have no side effects. This definition is reflected in the session model, which allows the DMT to be shared among readers. Therefore, plugins should refrain from causing side effects for read-only operations.

### 117.6.8 Copying

Plugins do not have to support the copy operation. They can throw a Dmt Exception with a code `FEATURE_NOT_SUPPORTED`. In this case, the Dmt Admin service must do the copying node by node. For the clients of the Dmt Admin service, it therefore appears that the copy method is always supported.

### 117.6.9 Scaffold Nodes

As Plugins can be mapped anywhere into the DMT it is possible that a part of the URI has no corresponding Plugin, such a plugin would not be *reachable* unless the intermediate nodes were provided. A program that would try to discover the DMT would not be able to find the registered Plugins as the intermediate nodes would not be discoverable.

These intermediate nodes that will make all plugins reachable must therefore be provided by the Dmt Admin service, they are called the *scaffold nodes*. The only purpose of the scaffold nodes is to allow every node to be discovered when the DMT is traversed from the root down. Scaffold nodes are provided both for Data Plugins as well as Exec Plugins as well as for Child Plugins that are mounted inside a Parent Plugin, see *Sharing the DMT* on page 500. In Figure 117.10 the Device node is a scaffold node because there is no plugin associated with it. The Dmt Admin service must, however, provide the Battery node as child node of the Device node.

Figure 117.10 Scaffold Nodes

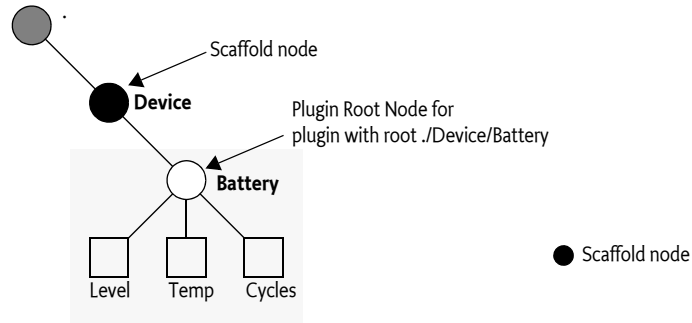

A scaffold node is always an interior node and has limited functionality, it must have a type of `DDF_SCAFFOLD`. It has no value, it is impossible to add or delete nodes to it, and the methods that are allowed for a scaffold node are specified in the following table.

Table 117.3 Supported Scaffold Node Methods

Method	Description
<code>getNodeAcl(String)</code>	Must inherit from the root node.
<code>getChildNodeNames(String)</code>	Answer the child node names such that plugin's in the sub-tree are reachable.
<code>getMetaNode(String)</code>	Provides the Meta Node defined in Table 117.4
<code>getNodeSize(String)</code>	Must throw a <code>DmtException</code> <code>COMMAND_NOT_ALLOWED</code>
<code>getNodeTitle(String)</code>	null
<code>getNodeTimestamp(String)</code>	Time first created
<code>getNodeType(String)</code>	<code>DDF_SCAFFOLD</code>
<code>isNodeUri(String)</code>	true
<code>isLeafNode(String)</code>	false
<code>getNodeVersion(String)</code>	Away returns 0
<code>copy(String,String,boolean)</code>	Not allowed for a single scaffold node as <code>nodeUri</code> , if the <code>recurse</code> parameter is false the <code>DmtException</code> <code>COMMAND_NOT_ALLOWED</code>

Any other operations must throw a `DmtException` with error code `COMMAND_NOT_ALLOWED`. The scope of a scaffold node is always `PERMANENT`. Scaffold nodes must have a Meta Node provided by the Dmt Admin service. This Meta Node must act as defined in the following table.

Table 117.4 Scaffold Meta Node Supported Methods

Method	Description
<code>can(int)</code>	<code>CMD_GET</code>
<code>getDefault()</code>	null

Method	Description
getDescription()	null
getFormat()	FORMAT_NODE
getMax()	Double.MAX_VALUE
getMaxOccurrence()	1
getMimeTypes()	DDF_SCAFFOLD
getMin()	Double.MIN_VALUE
getRawFormatNames()	null
getScope()	PERMANENT
getValidNames()	null
getValidValues()	null
isLeaf()	false
isValidName(String)	true
isValidValue(DmtData)	false
isZeroOccurrenceAllowed()	true

If a Plugin is registered then it is possible that a scaffold node becomes a Data Plugin root node. In that case the node and the Meta Node must subsequently be provided by the Data Plugin and can thus become different. Scaffold nodes are virtual, there are therefore no events associated with the life cycle of a scaffold node.

For example, there are three plugins registered:

URI	Plugin	Children
./A/B	P1	ba
./A/C	P2	ca
./A/X/Y	P3	ya, yb

In this example, node B, C, and Y are the plugin roots of the different plugins. As there is no plugin the manage node A and X these must be provided by the Dmt Admin service. In this example, the child names returned from each node are summarized as follows:

Node	Children	Provided by
.	{ A }	Dmt Admin (scaffold node)
A	{ X, C, B }	Dmt Admin (scaffold node)
B	{ ba }	P1
C	{ ca }	P2
X	{ Y }	Dmt Admin (scaffold node)
Y	{ ya, yb }	P3

Figure 117.11 Example Scaffold Nodes

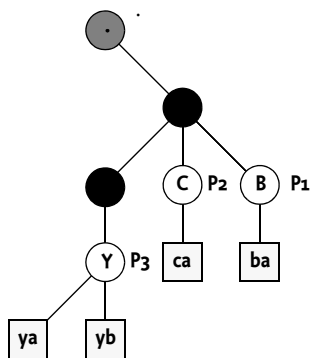

## 117.7 Sharing the DMT

The Dmt Admin service provides a model to integrate the management of the myriad of components that make up an OSGi device. This integration is achieved by sharing a single namespace: the DMT. Sharing a single namespace requires rules to prevent conflicts and to resolve any conflicts when Plugins register with plugin roots that overlap. It also requires rules for the Dmt Admin service when nodes are accessed for which there is no Plugin available.

This section defines the management of overlapping plugins through the *mount points*, places where a Parent Plugin can allow a Child Plugin to take over.

### 117.7.1 Mount Points

With multiple plugins the DMT is a *shared namespace*. Sharing requires rules to ensure that conflicts are avoided and when they occur, can be resolved in a consistent way. The most powerful and flexible model is to allow general overlapping. However, in practice this flexibility comes at the cost of ordering issues and therefore timing dependent results. A best practice is therefore to strictly control the points where the DMT can be extended for both Data and Exec Plugins.

A *mount point* is such a place. A Dmt Admin service at start up provides virtual mount points anywhere in the DMT and provides scaffold nodes for any intermediate nodes between the root of the DMT and the Plugin's root URI. Once a Plugin is mounted it is free to use its sub-tree (the plugin root and any ancestors) as it sees fit. However, this implies that the Plugin must implement the full sub-tree. In reality, many object models use a pattern where the different levels in the object model map to different domains.

For example, an Internet Gateway could have an object model where the general information, like the name, vendor, etc. is stored in the first level but any attached interfaces are stored in the sub-tree. However, it is highly unlikely that the code that handles the first level with the general information is actually capable of handling the details of, for example, the different network interfaces. It is actually likely that these network interfaces are dynamic. A Virtual Private Network (VPN) can add virtual network interfaces on demand. Such a could have the object model depicted in Figure 117.12.

Figure 117.12 Data Modeling

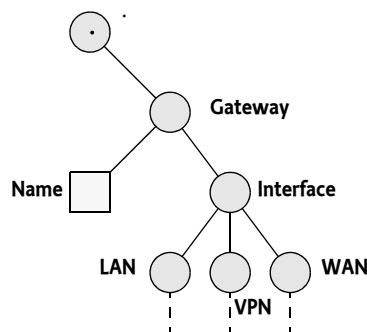

Forcing these different levels to be implemented by the same plugin violates one of the primary rules of modularity: *cohesion*. Plugins forced to handle all aspects become complex and hard to maintain. A Plugin like the one managing the Gateway node could provide its own Plugin mechanism but that would force a lot of replication and is error prone. For this reason, the Dmt Admin service allows a Plugin to provide *mount points* inside its sub-tree. A Plugin can specify that it has mount points by registering a `MOUNT_POINTS` service property (the constant is defined both in `DataPlugin` and `ExecPlugin` but have the same constant value). The type of this property must be `String+`, each string specifies a mount point. Each mount point is specified as a URI that is relative from the plug-



in root. That is, when the plugin root is `./A/B` and the mount point is specified as `C` then the absolute URI of the mount point is `./A/B/C`.

A Plugin that has mount points acts as a *Parent Plugin* to a number of *Child Plugins*. In the previous example, the LAN, VPN, and WAN nodes, can then be provided by separate Child Plugins even though the Gateway/Name node is provided by the Parent Plugin. In this case, the mount points are children of the Interface node.

A mount point can be used by a number of child plugins. In the previous example, there was a Child Plugin for the LAN node, the VPN node, and the WAN node. This model has the implicit problem that it requires coordination to ensure that their names are unique. Such a coordination between independent parties is complicated and error prone. It is therefore possible to force the Dmt Admin service to provide unique names for these nodes, see *Shared Mount Points* on page 502.

A Parent Plugin is not responsible for any scaffolding nodes to make its Child Plugins reachable. However, Dmt Admin may assume that a Plugin Root node always exists and may not provide a scaffold node on the Plugin Root. A Plugin is recommended to always provide the Plugin Root node to make its Child Plugins reachable. When a Parent Plugin provides the nodes to its mount points, the nodes should be the correct interior nodes to make its Child Plugins reachable.

For example, the following setup of plugins:

Plugin	Plugin Root	Mount Points
P1	<code>./A</code>	<code>X/B</code>
P2	<code>./A/X/B</code>	

This setup is depicted in Figure 117.13.

Figure 117.13 Example Scaffold Nodes For Child Plugin

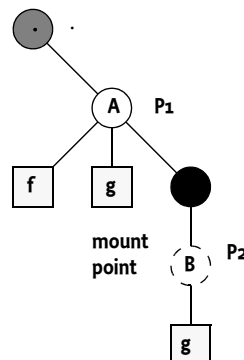

If the child node names are requested for the `./A` node then the plugin P1 is asked for the child node names and must return the names `[f,g]`. However, if plugin P2 is mapped then the Dmt Admin service must add the scaffold node name that makes this plugin reachable from that level, the returned set must therefore be `[f, g, X]`.

## 117.7.2 Parent Plugin

If a Plugin is registered with mount points then it is a *Parent Plugin*. A Parent Plugin must register with a single plugin root URI, that is the `DATA_ROOT_URI` or `EXEC_ROOT_URI` service properties must contain only one element. A Parent Plugin is allowed to be a Data and Exec Plugin at the same time. If a Parent Plugin is registered with multiple plugin root URIs then the Dmt Admin service must log an error and ignore the registration of such a Parent Plugin. A Parent Plugin can in itself also be a Child Plugin.

For example, a Plugin P1 that has a plugin root of `./A/B` and provides a mount point at `./A/B/C` and `./A/B/E/F`, as depicted in Figure 117.14.

Figure 117.14 Example Mount Points

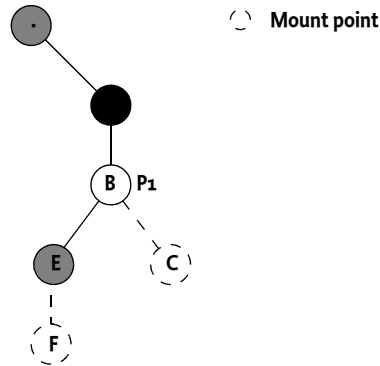

Registering such a Plugin would have to register the following service properties to allow the example configuration of the DMT:

```
dataRootUri      . /A/B
mountPoints      [ C, E/F ]
```

### 117-7-3 Shared Mount Points

Mount points can be shared between different Plugins. In the earlier example about the Gateway the Interface node contained a sub-tree of network interfaces. It is very likely in such an example that the Plugins for the VPN interface will be provided by a different organization than the WAN and LAN network interfaces. However, all these network interface plugins must share a single parent node, the Interface node, under which they would have to mount. Sharing therefore requires a prior agreement and a naming scheme.

The naming scheme is defined by using the number sign ('#' \u0023) to specify a *shared mount point*. A plugin root that ends with the number sign, for example `./A/B/#`, indicates that it is willing to get any node under node B, leaving the naming of that node up to the Dmt Admin service. Shared mount points cannot overlap with normal mount points, the first one will become mapped and subsequent ones are in error, they are incompatible with each other. A Parent Plugin must specify a mount point explicitly as a shared mount point by using the number sign at the end of the mount point's relative URI.

A plugin is compatible with other plugins if all other plugins specify a shared mount point to the same URI. It is compatible with its Parent Plugin if the child's plugin root and the mount point are either shared or not.

The Dmt Admin service must provide a name for a plugin root that identifies a shared mount point such that every Plugin on that mount point has a unique integer name for that node level. The integer name must be  $\geq 1$ . The name must be convertible to an int with the static `Integer.parseInt(String)` method.

A management system in general requires permanent links to nodes. It is therefore necessary to choose the same integer every time a plugin is mapped to a shared mount point. A Child Plugin on a shared mount point must therefore get a permanent integer node name when it registers with a Persistent ID (PID). That is, it registers with the service property `service.pid`. The permanent link is then coupled to the PID and the bundle id since different bundles must be able to use the same PID. If a Plugin is registered with multiple PIDs then the first one must be used. Since permanent links can stay around for a long time implementations must strive to not reuse these integer names.

If no PID is provided then the Dmt Admin service must choose a new number that has not been used yet nor matches any persistently stored names that are currently not registered.

The Gateway example would require the following Plugin registrations:

Root URI	Mount Points	Plugin	Role
./Gateway	[Interface/#]	Gateway	Parent
./Gateway/Interface/#	[]	WAN If.	Child
./Gateway/Interface/#	[]	LAN If.	Child
./Gateway/Interface/#	[]	VPN.1	Child

This setup is depicted in Figure 117.15.

Figure 117.15 Mount Point Sharing

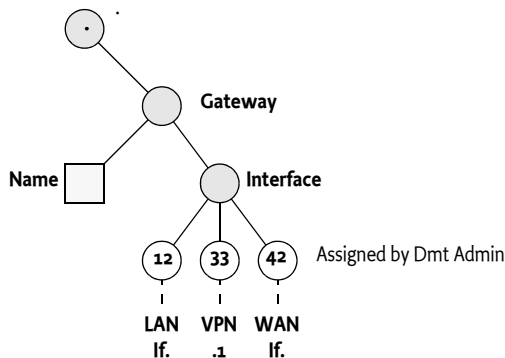

The Meta Node for a Node on the level of the Mount Point can specify either an existing Plugin or it can refer to a non-existing node. If the node exists, the corresponding Plugin must provide the Meta Node. If the node does not exist, the Dmt Admin service must provide the Meta Node. Such a Meta Node must provide the responses as specified in Table 117.4.

Table 117.5 Shared Mount Point Meta Node Supported Methods

Method	Description
can(int)	CMD_GET
getDefault()	null
getDescription()	null
getFormat()	FORMAT_NODE
getMax()	Double.MAX_VALUE
getMaxOccurrence()	Integer.MAX_VALUE
getMimeTypes()	null
getMin()	Double.MIN_VALUE
getRawFormatNames()	null
getScope()	The scope will depend on the Parent
getValidNames()	null
getValidValues()	null
isLeaf()	false
isValidName(String)	name >=1 && name < Integer.MAX_VALUE
isValidValue(DmtData)	false
isZeroOccurrenceAllowed()	true

A URI can cross multiple mount points, shared and unshared. For example, if a network interface could be associated with a number of firewall rules then it is possible to register a URI on the designated network interface that refers to the Firewall rules. For the previous example, a Plugin could register a Firewall if the following registrations were done:

Root URI	Mount Points	Plugin	Parent	Name
----------	--------------	--------	--------	------

./Gateway	[Interface/#]	Gw	
./Gateway/Interface/#	[Fw/#]	WAN If. Gw	11
./Gateway/Interface/#	[]	LAN If. Gw	33
./Gateway/Interface/#	[]	VPN.1 Gw	42
./Gateway/Interface/11/Fw/#	[]	Fw.1 WAN If.	97

This example DMT is depicted in Figure 117.16.

Figure 117.16 Mount Point Multiple Sharing

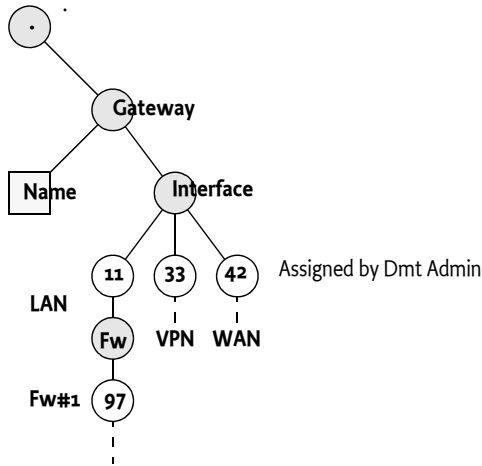

### 117.7.4 Mount Points are Excluded

Mount nodes are logically not included in the sub-tree of a Plugin. The Dmt Admin service must never ask any information from/about a Mount Point node to its Parent Plugin. A Parent Plugin must also not return the name of a mount point in the list of child node names, the Mount Point and its subtree is logically excluded from the sub-tree. For the Dmt Admin service an unoccupied mount point is a node that does not exist. Its name, must only be discoverable if a Plugin has actually mounted the node. The Dmt Admin service must ensure that the names of the mounted Plugins are included for that level.

In the case of shared mount points the Dmt Admin service must provide the children names of all registered Child Plugins that share that node level.

For example, a Plugin P1 registered with the plugin root of ./A/B, having two leaf nodes E, and a mount point C must not return the name C when the child node names for node B are requested. This is depicted in Figure 117.17. The Dmt Admin service must ensure that C is returned in the list of names when a Plugin is mounted on that node.

Figure 117.17 Example Exclusion

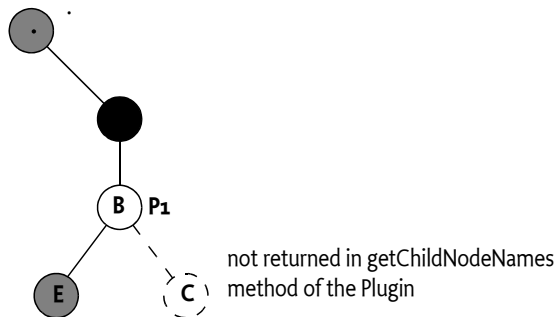

### 117.7.5 Mapping a Plugin

A Plugin is not stand alone, its validity can depend on other Plugins. Invalid states make it possible that a Plugin is either *mapped* or *unmapped*. When a Plugin is mapped it is available in the DMT and when it is unmapped it is not available. Any registration, unregistration, or modification of its services properties of a Plugin can potentially alter the mapped state of any related Plugin. A plugin becomes *eligible* for mapping when it is registered.

A plugin can have multiple roots. However, the mapping is described as if there is a single plugin root. Plugins with multiple roots must be treated as multiple plugins that can each independently be mapped or unmapped depending on the context.

If no Parent Plugin is available, the Dmt Admin service must act as a virtual Parent Plugin that allows mount points anywhere in the tree where there is no mapped plugin yet.

When a Plugin becomes eligible then the following assertions must be valid for that Plugin to become mapped:

- If it has one or more mount points then
  - It must have at most one Data and/or Exec Root URI.
  - None of its mount points must overlap.
  - Any already mapped Child Plugins must be compatible with its mount points.
- If no mount points are specified then there must be no Child Plugins already registered.
- The plugin root must be compatible with the corresponding parent's mount point. When a Parent Plugin is available, the plugin root must match exactly to the absolute URI of the parent's mount point.
- The plugin root must be compatible with any other plugins on that mount point.

If either of these assertions fail then the Dmt Admin service must log an error and ignore the registered Plugin, it must not become mapped. If, through the unregistration or modification of the service properties, the assertions can become valid then the Dmt Admin service must retry mapping the Plugin so that it can become available in the DMT. Any mappings and unmappings that affect nodes that are in the sub-tree of an active session must abort that session with a [CONCURRENT\\_ACCESS](#) exception.

When there are errors in the configuration then the ordering will define which plugins are mapped or not. Since this is an error situation no ordering is defined between conflicting plugins.

For example, a number of Plugins are registered in the given order:

Plugin Root	Children	Mount Points	Plugin
./A/B	E	C	P1
./A/B/C			P2
./A/B/D			P3

The first Plugin P1 will be registered immediately without problems. It has only a single plugin root as required by the fact that it is a Parent Plugin (it has a mount point). There are no Child Plugins yet so it is impossible to have a violation of the mount points. As there is no Parent Plugin registered, the Dmt Admin service will map plugin P1 and automatically provide the scaffold node A.

When Plugin P2 is registered its plugin root maps to a mount point in Plugin P1. As P2 is not a Parent Plugin it is only necessary that it has no Child Plugins. As it has no Child Plugins, the mapping will succeed.

Plugin P3 cannot be mapped because the Parent Plugin is P1 but P1 does not provide a mount point for P3's plugin root ./A/B/D.

If, at a later time P1 is unregistered then the Dmt Admin service must map plugin P3 and leave plugin P2 mapped. This sequence of action is depicted in Figure 117.18.

If plugin P1 becomes registered again at a later time it can then in its turn not be mapped as there would be a child plugin (P3) that would not map to its mount point.

Figure 117.18

## Plugin Activation

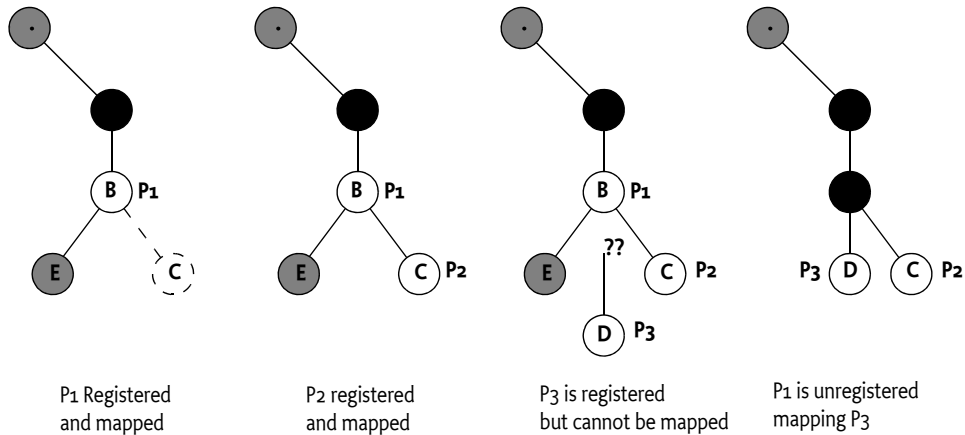

## 117.7.6

## Mount Plugins

In *Mapping a Plugin* on page 505 it is specified that a Plugin can be *mapped* or not. The mapped state of a Plugin can change depending on other plugins that are registered and unregistered. Plugins require in certain cases to know:

- What is the name of their root node if they mount on a shared mount point.
- What is the mapping state of the Plugin.

To find out these details a Plugin can implement the [MountPlugin](#) interface; this is a mixin interface, it is not necessary to register it as [MountPlugin](#) service. The Dmt Admin service must do an instance of operation on Data Plugin services and Exec Plugin services to detect if they are interested in the mount point information.

The Mount Point interface is used by the Dmt Admin service to notify the Plugin when it becomes mapped and when it becomes unmapped. The Plugin will be informed about each plugin root separately.

The Mount Plugin specifies the following methods that are called synchronously:

- [mountPointAdded\(MountPoint\)](#) - The Dmt Admin service must call this method after it has mapped a plugin root. From this point on the given mount point provides the actual path until the [mountPointRemoved\(MountPoint\)](#) is called with an equal object. The given Mount Point can be used to post events.
- [mountPointRemoved\(MountPoint\)](#) - The Dmt Admin service must call this method after it has unmapped the given mount point. This method must always be called when a plugin root is unmapped, even if this is caused by the unregistration of the plugin.

As the mapping and unmapping of a plugin root can happen any moment in time a Plugin that implements the Mount Plugin interface must be prepared to handle these events at any time on any thread.

The [MountPoint](#) interface has two separate responsibilities:

- *Path* - The path that this Mount Point is associated with. This path is a plugin root of the plugin. This path is identical to the Plugin's root except when it is mounted on a shared mount point; in that case the URI ends in the name chosen by the Dmt Admin service. The [getMountPath\(\)](#) method provides the path.

- *Events* - Post events about the given sub-tree that signal internal changes that occur outside a Dmt Session. The Dmt Admin service must treat these events as they were originated from modifications to the DMT. That is, they need to be forwarded to the Event Admin as well as the Dmt Listeners. For this purpose there are the `postEvent(String,String[],Dictionary)` and `postEvent(String,String[],String[],Dictionary)` methods.

For example, a Data Plugin monitoring one of the batteries registers with the following service properties:

```
dataRootURIs          ". /Device/Battery/#"
```

The Device node is from a Parent Plugin that provided the shared mount point. The Battery Plugin implements the `MountPlugin` interface so it gets called back when it is mapped. This will cause the Dmt Admin service to call the `mountPointAdded(MountPoint)` method on the plugin. In this case, it will get just one mount point, the mount point for its plugin root. If the Dmt Admin service would have assigned the Battery Plugin number 101 then the `getMountPath()` would return:

```
[ ".", "Device", "Battery", "101" ]
```

As the Plugin monitors the charge state of the battery it can detect a significant change. In that case it must send an event to notify any observers. The following code shows how this could be done:

```
@Component( properties="dataRootURIs=. /Device/Battery/#",
              provide=DataPlugin.class)
public class Battery implements DataPlugin, MountPlugin {
    Timer          timer;
    volatile float charge;
    TimerTask      task;

    public void mountPointsAdded(final MountPoint[] mountPoints){
        task = new TimerTask() {
            public void run() {
                float next = measure();
                if (Math.abs(charge - next) > 0.2) {
                    charge = next;
                    mountPoints[0].postEvent(DmtConstants.EVENT_TOPIC_REPLACED,
   new String[] { "Charge" }, null);
                }
            }
        };
        timer.schedule(task, 1000);
    }

    public void mountPointsRemoved(MountPoint[] mountPoints){
        task.cancel();
        task = null;
    }
    ... // Other methods
}
```

## 117.8 Access Control Lists

Each node in the DMT can be protected with an *access control list*, or *ACL*. An ACL is a list of associations between *Principal* and *Operation*:

- *Principal* - The identity that is authorized to use the associated operations. Special principal is the wildcard ('\*' \u002A); the operations granted to this principal are called the *global permissions*. The global permissions are available to all principals.
- *Operation* - A list of operations: ADD, DELETE, GET, REPLACE, EXECUTE.

DMT ACLs are defined as strings with an internal syntax in [1] *OMA DM-TND v1.2 draft*. Instances of the ACL class can be created by supplying a valid OMA DM ACL string as its parameter. The syntax of the ACL is presented here in shortened form for convenience:

```
acl          ::= ( acl-entry ( '&' acl-entry)* )
acl-entry    ::= command '=' ( principals | '*' )
principals  ::= principal ( '+' principal )*
principal    ::= -[' ' '&' '*' '+' '\t' '\n' '\r']+
```

The principal name should only use printable characters according to the OMA DM specification.

```
command      ::= 'Add' | 'Delete' | 'Exec' | 'Get' | 'Replace'
```

White space between tokens is not allowed.

Examples:

```
Add=*&Replace=*&Get=*
```

```
Add=www.sonera.fi-8765&Delete=www.sonera.fi-8765&
Replace=www.sonera.fi-8765+321_ibm.com&Get=*
```

The `Acl(String)` constructor can be used to construct an ACL from an ACL string. The `toString()` method returns a String object that is formatted in the specified form, also called the canonical form. In this form, the principals must be sorted alphabetically and the order of the commands is:

```
ADD, DELETE, EXEC, GET, REPLACE
```

The `Acl` class is immutable, meaning that a `Acl` object can be treated like a string, and that the object cannot be changed after it has been created.

ACLs must only be verified by the Dmt Admin service when the session has an associated principal.

ACLs are properties of nodes. If an ACL is *not set* (i.e. contains no commands nor principals), the *effective* ACL of that node must be the ACL of its first ancestor that has a non-empty ACL. This effective ACL can be acquired with the `getEffectiveNodeAcl(String)` method. The root node of DMT must always have an ACL associated with it. If this ACL is not explicitly set, it should be set to `Add=*&Get=*&Replace=*`.

This effect is shown in Figure 117.19. This diagram shows the ACLs set on a node and their effect (which is shown by the shaded rectangles). Any principal can get the value of p, q and r, but they cannot replace, add or delete the node. Node t can only be read and replaced by principal S1.

Node X is fully accessible to any authenticated principal because the root node specifies that all principals have Get, Add and Replace access (\*->G,A,R).



Figure 117.19 ACL inheritance

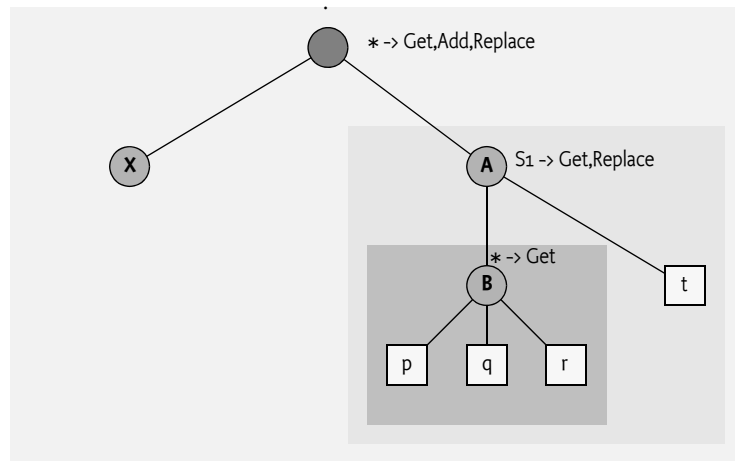

The definition and example demonstrate the access rights to the properties of a node, which includes the value.

Changing the ACL property itself has different rules. If a principal has Replace access to an interior node, the principal is permitted to change its own ACL property *and* the ACL properties of all its child nodes. Replace access on a leaf node does not allow changing the ACL property itself.

In the previous example, only principal S1 is authorized to change the ACL of node B because it has Replace permission on node B's parent node A.

Figure 117.20 ACLs for the ACL property

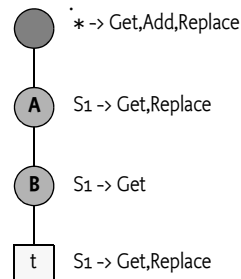

Figure 117.20 demonstrates the effect of this rule with an example. Server S1 can change the ACL properties of all interior nodes. A more detailed analysis:

- *Root* - The root allows all authenticated principals to access it. The root is an interior node so the Replace permission permits the change of the ACL property.
- *Node A* - Server S1 has Replace permission and node A is an interior node so principal S1 can modify the ACL.
- *Node B* - Server S1 has no Replace permission for node B, but the parent node A of node B grants principal S1 Replace permission, and S1 is therefore permitted to change the ACL.
- *Node t* - Server S1 must not be allowed to change the ACL of node t, despite the fact that it has Replace permission on node t. For leaf nodes, permission to change an ACL is defined by the Replace permission in the parent node's ACL. This parent, node B, has no such permission set and thus, access is denied.

The following methods provide access to the ACL property of the node.

- `getNodeAcl(String)` - Return the ACL for the given node, this method must not take any ACL inheritance into account. The ACL may be null if no ACL is set.
- `getEffectiveNodeAcl(String)` - Return the effective ACL for the given node, taking any inheritance into account.
- `setNodeAcl(String,Acl)` - Set the node's ACL. The ACL can be null, in which case the effective permission must be derived from an ancestor. The Dmt Admin service must call `nodeChanged(String[])` on the data session with the given plugin to let the plugin update any timestamps and versions.

The `Acl` class maintains the permissions for a given principal in a bit mask. The following permission masks are defined as constants in the `Acl` class:

- `ADD`
- `DELETE`
- `EXEC`
- `GET`
- `REPLACE`

The class features methods for getting permissions for given principals. A number of methods allow an existing ACL to be modified while creating a new ACL.

- `addPermission(String,int)` - Return a new `Acl` object where the given permissions have been added to permissions of the given principal.
- `deletePermission(String,int)` - Return a new `Acl` object where the given permissions have been removed from the permissions of the given principal.
- `setPermission(String,int)` - Return a new `Acl` object where the permissions of the given principal are overwritten with the given permissions.

Information from a given ACL can be retrieved with:

- `getPermissions(String)` - (int) Return the combined permission mask for this principal.
- `getPrincipals()` - (String[]) Return a list of principals (String objects) that have been granted permissions for this node.

Additionally, the `isPermitted(String,int)` method verifies if the given ACL authorizes the given permission mask. The method returns true if all commands in the mask are allowed by the ACL.

For example:

```
Acl acl = new Acl("Get=S1&Replace=S1");

if ( acl.isPermitted("S1", Acl.GET+Acl.REPLACE ) )
    ... // will execute

if ( acl.isPermitted(
    "S1", Acl.GET+Acl.REPLACE+Acl.ADD ) )
    ... // will NOT execute
```

### 117.8.1

## Global Permissions

Global permissions are indicated with the '\*' and the given permissions apply to all principals. Processing the global permissions, however, has a number of non-obvious side effects:

- Global permissions can be retrieved and manipulated using the special '\*' principal: all methods of the `Acl` class that have a principal parameter also accept this principal.

- Global permissions are automatically granted to all specific principals. That is, the result of the `getPermissions` or `isPermitted` methods will be based on the OR of the global permissions and the principal-specific permissions.
- If a global permission is revoked, it is revoked from all specific principals, even if the specific principals already had that permission before it was made global.
- None of the global permissions can be revoked from a specific principal. The OMA DM ACL format does not handle exceptions, which must be enforced by the `deletePermission` and `setPermission` methods.

### 117.8.2 Ghost ACLs

The ACLs are fully maintained by the Dmt Admin service and enforced when the session has an associated principal. A plugin must be completely unaware of any ACLs. The Dmt Admin service must synchronize the ACLs with any change in the DMT that is made through its service interface. For example, if a node is deleted through the Dmt Admin service, it must also delete an associated ACL.

The DMT nodes, however, are mapped to plugins, and plugins can delete nodes outside the scope of the Dmt Admin service.

As an example, consider a configuration record which is mapped to a DMT node that has an ACL. If the configuration record is deleted using the Configuration Admin service, the data disappears, but the ACL entry in the Dmt Admin service remains. If the configuration dictionary is recreated with the same PID, it will get the old ACL, which is likely not the intended behavior.

This specification does not specify a solution to solve this problem. Suggestions to solve this problem are:

- Use a proprietary callback mechanism from the underlying representation to notify the Dmt Admin service to clean up the related ACLs.
- Implement the services on top of the DMT. For example, the Configuration Admin service could use a plugin that provides general data storage service.

## 117.9 Notifications

In certain cases it is necessary for some code on the device to alert a remote management server or to initiate a session; this process is called sending a notification or an *alert*. Some examples:

- A Plugin that must send the result of an asynchronous EXEC operation.
- Sending a request to the server to start a management session.
- Notifying the server of completion of a software update operation.

Notifications can be sent to a management server using the `sendNotification(String,int,String,AlertItem[])` method on the Notification Service. This method is on the Notification Service and not on the session, because the session can already be closed when the need for an alert arises. If an alert is related to a session, the session can provide the required principal, even after it is closed.

The remote server is alerted with one or more `AlertItem` objects. The `AlertItem` class describes details of the alert. An alert code is an alert type identifier, usually requiring specifically formatted `AlertItem` objects.

The data syntax and semantics vary widely between various alerts, and so does the optionality of particular parameters of an alert item. If an item, such as source or type, is not defined, the corresponding getter method must return null.

The `AlertItem` class contains the following items. The value of these items must be defined in an alert definition:

- `source` - (String) The URI of a node that is related to this request. This parameter can be null.
- `type` - (String) The type of the item. For example, `x-oma-application:syncml.samplealert` in the Generic Alert example.
- `mark` - (String) Mark field of an alert. Contents depend on the alert type.
- `data` - (DmtData) The payload of the alert with its type.

An `AlertItem` object can be constructed with two different constructors:

- `AlertItem(String,String,String,DmtData)` - This method takes all the previously defined fields.
- `AlertItem(String[],String,String,DmtData)` - Same as previous but with a convenience parameter for a segmented URI.

The Notification Service provides the following method to send `AlertItem` objects to the management server:

- `sendNotification(String,int,String,AlertItem[])` - Send the alert to the server that is associated with the session. The first argument is the name of the principal (identifying the remote management system) or null for implementation defined routing. The `int` argument is the *alert type*. The alert types are defined by *managed object types*. The third argument (String) can be used for the correlation id of a previous execute operation that triggered the alert. The `AlertItem` objects contain the data of the alert. The method will run asynchronously from the caller. The Notification Service must provide a reliable delivery method for these alerts. Alerts must therefore not be re-transmitted.

When this method is called with null correlator, null or empty `AlertItem` array, and a 0 code as values, it should send a protocol specific notification that must initiate a new management session.

Implementers should base the routing on the session or server information provided as a parameter in the `sendNotification(String,int,String,AlertItem[])` method. Routing might even be possible without any routing information if there is a well known remote server for the device.

If the request cannot be routed, the Alert Sender service must immediately throw a Dmt Exception with a code of `ALERT_NOT_ROUTED`. The caller should not attempt to retry the sending of the notification. It is the responsibility of the Notification Service to deliver the notification to the remote management system.

### 117.9.1 Routing Alerts

The Notification Service allows external parties to route alerts to their destination. This mechanism enables Protocol Adapters to receive any alerts for systems with which they can communicate.

Such a Protocol Adapter should register a Remote Alert Sender service. It should provide the following service property:

- *principals* - (String+) The array of principals to which this Remote Alert Sender service can route alerts. If this property is not registered, the Remote Alert Sender service will be treated as the default sender. The default alert sender is only used when a more specific alert sender cannot be found.

If multiple Remote Alert Sender services register for the same principals highest ranking service is taken as defined in the OSGi Core.

## 117.10 Exceptions

Most of the methods of this Dmt Admin service API throw Dmt Exceptions whenever an operation fails. The `DmtException` class contains numeric error codes which describe the cause of the error. Some of the error codes correspond to the codes described by the OMA DM spec, while some are introduced by the OSGi Alliance. The documentation of each method describes what codes could potentially be used for that method.

The fatality of the exception decides if a thrown Exception rolls back an atomic session or not. If the `isFatal()` method returns true, the Exception is fatal and the session must be rolled back.

All possible error codes are constants in the `DmtException` class.

## 117.11 Events

There are the following mechanisms to work with events when using the Dmt Admin service.

- *Event Admin service* - Standard asynchronous notifications
- *Dmt Event Listener service* - A white board model for listener. A registered `DmtEventListener` service can use service properties to filter the received events

In both cases events are delivered asynchronously and ordered per listener unless otherwise specified. Events to the DMT can occur because of modifications made in a session or they can occur because a Plugin changes its internal state and notifies the Dmt Admin service through the `MountPoint` interface.

Changes made through a session always start with a `SESSION_OPENED` event directly after the session is opened. This event must contain the properties defined in *Life Cycle Event Properties* on page 516.

If events originate from an atomic session then these events must be queued until the sessions is successfully committed, which can happen multiple times over the life time of a session. If the session is rolled back or runs into an error then none of the queued events must be sent.

When a session is closed, which can happen automatically when the session fails, then the `SESSION_CLOSED` event must be sent. This event must happen after any queued events. This closed event must contain the properties defined in *Life Cycle Event Properties* on page 516.

An event must only be sent when that type of event actually occurred.

### 117.11.1 Event Admin

Event Admin, when present, must be used to deliver the Dmt Admin events asynchronously. The event types are specified in Table 117.7 on page 514, the Topic column defines the Event Admin topic. The Table 117.10 on page 516 and Table 117.9 on page 516 define the Life Cycle and Session properties that must be passed as the event properties of Event Admin.

### 117.11.2 Dmt Event Listeners

To receive the Dmt Admin events it is necessary to register a Dmt Event Listener service. It is possible to filter the events by registering a combination of the service properties defined in the following table.

Table 117.6 Service Properties for the Dmt Event Listener

Service Property	Data Type	Default	Description
<a href="#">FILTER_EVENT</a>	Integer	All Events	A bitmap of <a href="#">DmtEvent</a> types: <a href="#">SESSION_OPENED</a> , <a href="#">ADDED</a> , <a href="#">COPIED</a> , <a href="#">DELETED</a> , <a href="#">REPLACED</a> , and <a href="#">SESSION_CLOSED</a> . A Dmt Event's type must occur in the bitmap to be delivered.
<a href="#">FILTER_PRINCIPAL</a>	String+	Any node	Only deliver Dmt Events for which at least one of the given principals has the right to Get that node.
<a href="#">FILTER_SUBTREE</a>	String+	Any node	This property defines a number of sub-trees by specifying the URI of the top nodes of these sub-trees. Only events that occur in one of the sub-trees must be delivered.

A Dmt Event must only be delivered to a Dmt Event Listener if the Bundle that registers the Dmt Event Listener service has the [GET](#) Dmt Permission for each of the nodes used in the nodes and newNodes properties as tested with the Bundle hasPermission method.

The Dmt Admin service must track Dmt Event Listener services and deliver matching events as long as a Dmt Event Listener service is registered. Any changes in the service properties must be expediently handled.

A Dmt Event Listener must implement the [changeOccurred\(DmtEvent\)](#) method. This method is called asynchronously from the actual event occurrence but each listener must receive the events in order.

Events are delivered with a [DmtEvent](#) object. This object provides access to the properties of the event. Some properties are available as methods others must be retrieved through the [getProperty\(String\)](#) method. The methods that provide property information are listed in the property tables, see Table 117.10 on page 516.

### 117.11.3 Atomic Sessions and Events

The intent of the events is that a listener can follow the modifications to the DMT from the events alone. However, from an efficiency point of view certain events should be coalesced to minimize the number of events that a listener need to handle. For this reason, the Dmt Admin service must coalesce events if possible.

Two consecutive events can be coalesced when they are of the same type. In that case the nodes and, if present, the newNodes of the second event can be concatenated with the first event and the timestamp must be derived from the first event. It is not necessary to remove duplicates from the nodes and newNodes. This guarantees that the order of the nodes is in the order of the events.

### 117.11.4 Event Types

This section describes the events that can be generated by the Dmt Admin service. Table 117.7 enumerates all the events and provides the name of the topic of Event Admin and the Dmt Event type for the listener model.

There are two kinds of events:

- *Life Cycle Events* - The events for session open and closed are the session events.
- *Session Events* - [ADDED](#), [DELETED](#), [REPLACED](#), [RENAMED](#), and [COPIED](#).

Session and life cycle events have different properties.

Table 117.7 Event Types

Event	Topic	Dmt Event Type	Description
SESSION OPENED	org/osgi/service/dmt/DmtEvent/ SESSION_OPENED	<a href="#">SESSION_OPENED</a>	A new session was opened. The event must the properties defined in Table 117.9 on page 516.

Event	Topic	Dmt Event Type	Description
ADDED	org/osgi/service/dmt/DmtEvent/ ADDED	ADDED	One or more nodes were added.
DELETED	org/osgi/service/dmt/DmtEvent/ DELETED	DELETED	One or more existing nodes were deleted.
REPLACED	org/osgi/service/dmt/DmtEvent/RE- PLACED	REPLACED	Values of nodes were replaced.
RENAMED	org/osgi/service/dmt/DmtEvent/RE- NAMED	RENAMED	Existing nodes were renamed.
COPIED	org/osgi/service/dmt/DmtEvent/ COPIED	COPIED	Existing nodes were copied. A copy operation does not trigger an ADDED event (in addition to the COPIED event), even though new node(s) are created. For efficiency reasons, recursive copy and delete operations must only generate a single COPIED and DELETED event for the root of the affected sub-tree.
SESSION CLOSED	org/osgi/service/dmt/DmtEvent/ SESSION_CLOSED	SESSION_CLOSED	A session was closed either because it was closed explicitly or because there was an error detected. The event must the properties defined in Table 117.9 on page 516.

### 117.11.5 General Event Properties

The following properties must be available as the event properties in Event Admin service and the properties in the Dmt Event for Dmt Event Listener services.

Table 117.8 General Event

Property Name	Type	Dmt Event	Description
event.topics	String		Event topic, required by Event Admin but must also be present in the Dmt Events.
session.id	Integer	<code>getSessionId()</code>	A unique identifier for the session that triggered the event. This property has the same value as <code>getSessionId()</code> of the associated DMT session. If this event is generated outside a session then the session id must be -1, otherwise it must be $\geq 1$ .
timestamp	Long		The time the event was started as defined by <code>System.currentTimeMillis()</code>
bundle	Bundle		The initiating Bundle, this is the bundle that caused the event. This is either the Bundle that opened the associated session or the Plugin's bundle when there is no session (i.e. the session id is -1).
bundle.signer	String+		The signer of the initiating Bundle
bundle.symbolicName	String		The Bundle Symbolic name of the initiating Bundle
bundle.version	Version		The Bundle version of the initiating Bundle.
bundle.id	Long		The Bundle Id of the initiating Bundle.

### 117.11.6 Session Event Properties

All session events must have the properties defined in the following table.

Table 117.9 *Event Properties For Session Events*

Property Name	Type	Dmt Session	Description
session.rooturi	String	<a href="#">getRootUri()</a>	The root URI of the session that triggered the event.
session.principal	String	<a href="#">getPrincipal()</a>	The principal of the session, or absent if no principal is associated with this session. In the latter case the method returns null.
session.locktype	Integer	<a href="#">getLockType()</a>	The lock type of the session. The number is mapped as follows: <ul style="list-style-type: none"> <li>• <a href="#">LOCK_TYPE_SHARED</a> - 0</li> <li>• <a href="#">LOCK_TYPE_EXCLUSIVE</a> - 1</li> <li>• <a href="#">LOCK_TYPE_ATOMIC</a> - 2</li> </ul>
session.timeout	Boolean		If the session timed out then this property must be set to true. If it did not time out this property must be false.
exception	Throwable		The name of the actual exception class if the session had a fatal exception.
exception.message	String		Must describe the exception if the session had a fatal exception.
exception.class	String		The name of the actual exception class if the session had a fatal exception.

### 117.11.7 Life Cycle Event Properties

All Life Cycle events must have the properties defined in the following table.

Table 117.10 *Event Properties for Life Cycle Events*

Property Name	Type	Dmt Event	Description
nodes	String[]	<a href="#">getNodes()</a>	The absolute URIs of each affected node. This is the <code>nodeUri</code> parameter of the Dmt API methods. The order of the URIs in the array corresponds to the chronological order of the operations. In case of a recursive delete or copy, only the session root URI is present in the array.
newnodes	String[]	<a href="#">getNewNodes()</a>	The absolute URIs of new renamed or copied nodes. Only the RENAMED and COPIED events have this property.  The <code>newnodes</code> array runs parallel to the <code>nodes</code> array. In case of a rename, <code>newnodes[i]</code> must contain the new name of <code>nodes[i]</code> , and in case of a copy, <code>newnodes[i]</code> is the URI to which <code>nodes[i]</code> was copied.

### 117.11.8 Example Event Delivery

The example in this section shows the change of a non-trivial tree and the events that these changes will cause.



Figure 117.21 Example DMT before

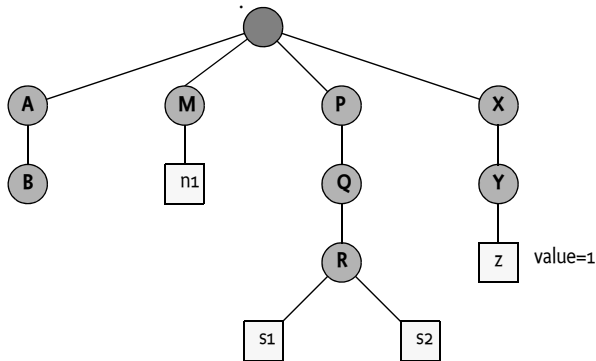

For example, in a given session, when the DMT in Figure 117.21 is modified with the following operations:

- Open atomic session 42 on the root URI
- Add node `./A/B/C`
- Add node `./A/B/C/D`
- Rename `./M/n1` to `./M/n2`
- Copy `./M/n2` to `./M/n3`
- Delete node `./P/Q`
- Add node `./P/Q`
- Delete node `./P/Q`
- Replace `./X/Y/z` with 3
- Commit
- Close

Figure 117.22 Example DMT after

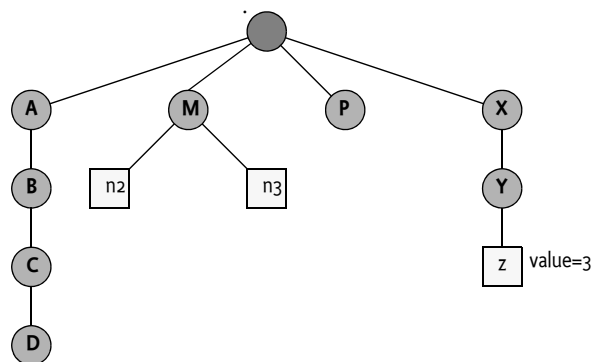

When the Dmt Session is opened, the following event is published:

```
SESSION_OPENED {
    session.id = 42
    session.rooturi=.
    session.principal=null
    session.locktype=2
}
```

```

        timestamp=1313411544752
        bundle =<Bundle>
        bundle.signer=[]
        bundle.symbolicname"com.acme.bundle"
        bundle.version=1.2.4711
        bundle.id=442
        ...
    }

```

When the Dmt Session is closed (assuming it is atomic), the following events are published:

```

ADDED {
    nodes = [ ./A/B/C, ./A/B/C/D ]      # note the coalescing
    session.id = 42
    ...
}
RENAMED {
    nodes = [ ./M/n1 ]
    newnodes = [ ./M/n2 ]
    session.id = 42
    ...
}
COPIED {
    nodes = [ ./M/n2 ]
    newnodes = [ ./M/n3 ]
    session.id = 42
    ...
}
DELETED {
    nodes = [ ./P/Q ]
    session.id = 42
    ...
}
ADDED {
    nodes = [ ./P/Q ]
    session.id = 42
    ...
}
DELETED {
    nodes = [ ./P/Q ]
    session.id = 42
    ...
}
REPLACED {
    nodes = [ ./X/Y/z ]
    session.id = 42
    ...
}
SESSION_CLOSED {
    session.id = 42
    session.rooturi=.
    session.principal=null
    session.locktype=2
    ...
}

```

## 117.12 OSGi Object Modeling

### 117.12.1 Object Models

Management protocols define only half the picture; the object models associated with a particular protocol are the other half. Object models are always closely associated with a remote management protocol since they are based on the data types and actions that are defined in the protocol. Even small differences between the data types of a protocol and its differences make accurate mapping between protocols virtually impossible. It is therefore necessary to make the distinction between *native* and *foreign* protocols for an object model.

A native protocol for an object model originates from the same specification organization. For example, OMA DM consists of a protocol based on SyncML and a number of object models that define the structure and behavior of the nodes of the DMT. The FOMA specification defines an OMA DM native object model, it defines how firmware management is done. This is depicted in Figure 117.23.

Figure 117.23 Device Management Architecture

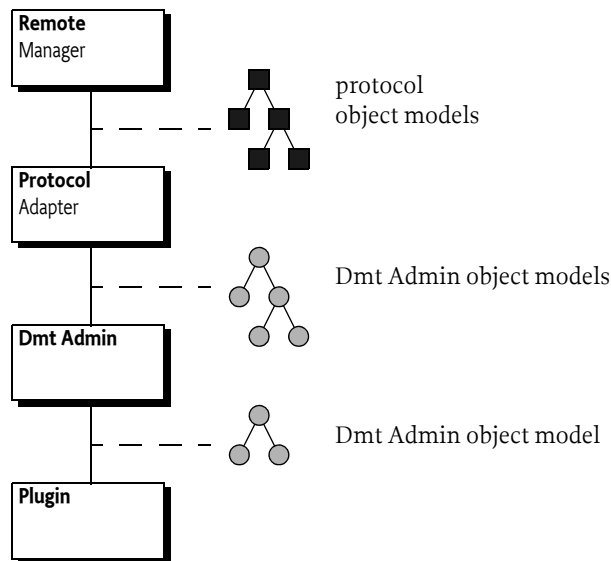

If an object implements a standardized data model it must be visible through its *native* Protocol Adapter, that is the Protocol Adapter that belongs to the object model's standard. For example, an ExecutionUnit node defined in UPnP Device Management could be implemented as a bundle, exposed through a Data Plugin for the Dmt Admin service, and then translated by its native UPnP Protocol Adapter.

If an object is present in the Dmt Admin service it is also available to *foreign* Protocol Adapters. A foreign Protocol Adapter is any Protocol Adapter except its native Protocol Adapter. For example, the Broadband Forum's ExecutionUnit could be browsed on the foreign OMA DM protocol.

In a foreign Protocol Adapter the object model should be *browsable* but it would not map to one of its native object models. Browsable means that the information is available to the Protocol Adapter's remote manager but not recognized as a standard model for the manager. Browse can include, potentially limited, manipulation.

In a native Protocol Adapter it is paramount that the mapping from the DMT to the native object is fully correct. It is the purpose of this part of the Dmt Admin service specification to allow the native Protocol Adapter to map the intentions of the Plugin without requiring knowledge of the specific native object model. That is, a TR-069 Plugin implementing a WAN interface must be available over

the TR-069 protocol without the Protocol Adapter having explicit knowledge about the WAN interfaces object models from Broadband Forum.

Therefore, the following use cases are recognized:

- *Foreign Mapping* - Foreign mapping can be best-effort as there is no object model to follow. Each Protocol Adapter must define how the Dmt Admin model is mapped for this browse mode.
- *Native Mapping* - Native mapping must be 100% correct. As it is impossible automatically map DMTs to arbitrary protocols this specification provides the concept of a mapping model that allows a Plugin to instruct its native Protocol Adapter using Meta Nodes.

### 117.12.2 Protocol Mapping

The OSGi Alliance specifies an Execution Environment that can be used as a basis for residential gateways, mobiles, or other devices. This raises the issue how to expose the manageability of an OSGi device and the *objects*, the units of manageability, that are implemented through Plugins. Ideally, an object should be able to expose its management interface once and then Protocol Adapters convert the management interface to specific device management stacks. For example, an object can be exposed through the Dmt Admin service where then a TR-069 Protocol Adapter maps the DMT to the TR-069 Remote Procedure Calls (RPC).

Figure 117.24 shows an example of a TR-069 Protocol Adapter and an OMA DM Protocol Adapter. The TR-069 Protocol Adapter should be able to map native TR-069 objects in the DMT (the Software Modules Impl in the figure) to Broadband Forum's object models. It should also be able to browse the foreign DMT and other objects that are not defined in Broadband forum but can be accessed with the TR-069 RPCs.

Figure 117.24 Implementing & Browsing

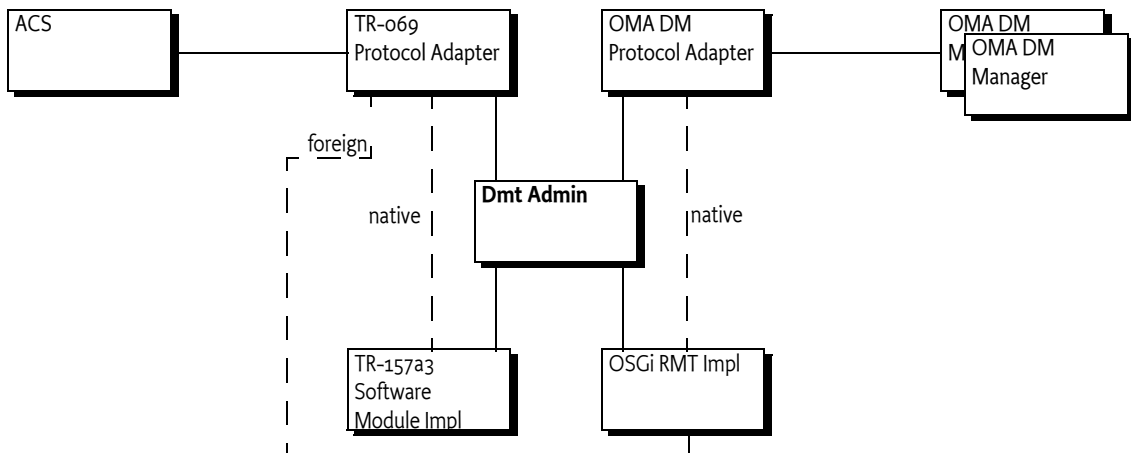

A *Protocol Mapping* is a document that describes the default mapping and the native mechanism for exact mapping.

The following sections specify how Plugins must implement an object model that is exposed through the Dmt Admin service. This model is limited from the full Dmt Admin service capabilities so that for each protocol it is possible to specify a default mapping for browsing as well as a mechanism to ensure that special conversion requirements can be communicated from a Plugin to its native Protocol Adapter.

### 117.12.3 Hierarchy

The Dmt Admin model provides an hierarchy of *nodes*. Each node has a *type* that is reflected by its Meta Node. A node is addressed with a URI. The flexibility of the Dmt Admin service allows a large

number of constructs, for example, the name of the node can be used as a *value*, a feature that some management standards support. To simplify mapping to foreign Protocol Adapters, some of the fundamental constructs have been defined in the following sections.

### 117.12.4 General Restriction Guidelines

The Dmt Admin service provides a very rich tool to model complex object structures. Many choices can be made that would make it very hard to browse DMTs on non-OMA DM protocols or make the DMT hard to use through the Dmt Admin service. As Plugins can always signal special case handling to their native Protocol Adapter, any object model design should strive to be easy to use for the developers and managers. Therefore, this section provides a number of guidelines for the design of such object models that will improve the browsing experience for many Protocol Adapters.

- *Reading of a node must not change the state of a device* - Management systems must be able to browse a tree without causing any side effects. If reading modified the DMT, a management system would have no way to warn the user that the system is modified. There are a number of technical reasons as well (race conditions, security holes, and eventing) but the most important reason is the browseability of the device.
- *No use of recursive structures* - The Dmt Admin service provides a very rich tree model that has no problem with recursion. However, this does not have to be true for other models. To increase the changes that a model is browsable on another device it is strongly recommended to prevent recursive models. For example, TR-069 cannot handle recursive models.
- *Only a single format per meta node* - Handling different types in different nodes simplifies the data conversion for both foreign and native protocols. Having a single choice from the Meta Node makes the conversion straightforward and does not require guessing.
- *All nodes must provide a Meta Node* - Conversion without a Meta Node makes the conversion very hard since object model schemas are often not available in the Protocol Adapter.
- *Naming* - Structured node members must have names only consisting of [a-zA-Z0-9] and must always start with a character [a-zA-Z]. Member names must be different regardless of the case, that is Abc and ABC must not both be members of the same structured node. The reason for this restriction is that it makes it more likely that the chosen names are compatible with the supported protocols and do not require escaping.
- *Typing* - Restrict the used formats to formats that maximize both the interoperability as the ease of use for Java developers. The following type are widely supported and are easy to use from Java:
  - [FORMAT\\_STRING](#)
  - [FORMAT\\_BOOLEAN](#)
  - [FORMAT\\_INTEGER](#)
  - [FORMAT\\_LONG](#)
  - [FORMAT\\_FLOAT](#)
  - [FORMAT\\_DATE\\_TIME](#)
  - [FORMAT\\_BINARY](#)

### 117.12.5 DDF

The Data Description Format is part of OMA DM; it provides a description language for the object model. The following table provides an example of the Data Description Format as used in the OSGi specifications.

Name	Actions	Type	Card.	S	Description
FaultType	Get	integer	1	P	...

The columns have the following meanings:

- *Name* - The name of the node

- *Actions* - The set of actions that can be executed on the node, see *Operations* on page 492.
- *Type* - The type of the node. All lower case are primitives, a name starting with an upper case is an interior node type. MAP, LIST, and SCAFFOLD are the special types. The NODE type is like an ANY type. Other type names are then further specified in the document. See *Types* on page 522.
- *Cardinality* - The number of occurrences of the node, see *Cardinality* on page 493.
- *Scope* - The scope of the node, see *Scope* on page 492.
- *Description* - A description of the node.

## 117.12.6 Types

Each node is considered to have a *type*. The Dmt Admin service has a number of constructs that have typing like behavior. There are therefore the following *kind* of types:

- *Primitives* - Primitives are data types like integers and strings; they include all the Dmt Admin data formats. See *Primitives* on page 523. Primitive type names are always lower case to distinguish them from the interior node type names.
- *Structured Types* - A structured type types a structured node. See *Structured Nodes* on page 523. A structured type has a type name that starts with an uppercase. Object models generally consist of defining these types.
- **NODE** - A general unqualified Dmt Admin node.
- **LIST** - A node that represents a homogeneous collection of child nodes; the name of the child nodes is the index in the collection. See *LIST Nodes* on page 523.
- **MAP** - A node that represents a mapping from a key, the name of the child node, and a value, the value of the child node. All values have the same type. See *MAP Nodes* on page 525.
- **SCAFFOLD** - A node provided by the Dmt Admin service or a Parent Plugin to make it possible to discover a DMT, see *Scaffold Nodes* on page 497.

Nodes are treated as if there is a single type system. However, the Dmt Admin type system has the following mechanisms to type a node:

- *Format* - The Dmt Admin primitive types used for leaf nodes, as defined on Dmt Data.
- *MIME* - A MIME type on a leaf node which is available through `getNodeType(String)`.
- *DDF Document URI* - A Data Description Format URI that provides a type name for an interior node. The URI provides a similar role as the MIME type for the leaf node and is also available through `getNodeType(String)`.

The Dmt Admin service provides the MIME type for leaf nodes and the DDF Document URI for interior nodes through the `getNodeType(String)` method. As both are strings they can both be used as type identifiers. The different types are depicted in Figure 117.25.

Figure 117.25 Type inheritance and structure

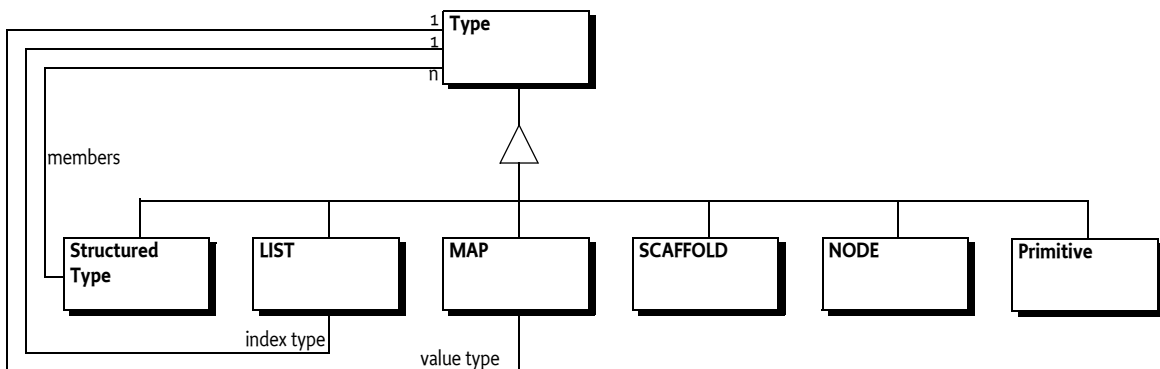

### 117.12.7 Primitives

A primitive is a value stored in a leaf node. In the Dmt Admin service, the type of the primitive is called the *format*. The Dmt Admin service supports a large number of types that have semantic overlap. A Protocol Mapping must provide a unique mapping from each Dmt Admin format to the corresponding protocol type and provide conversion from a protocol type to the corresponding Dmt Admin types defined in a Meta Node.

Primitives are documented in OSGi object models with a lower case name that is the last part of their format definition. For example, for `FORMAT_STRING` the DDF type name is string. A primitive DDF for an integer leaf node therefore looks like:

Name	Act	Type	Card.	S	Description
FaultType	Get	integer	1	P	...

### 117.12.8 Structured Nodes

A *structured node* is like a struct in C or a class in an object oriented languages. A structured node is an interior node with a set of members (child nodes) with fixed names, it is never possible to add or remove such members dynamically. The meaning of each named node and its type is usually defined in a management specification. For example, a node representing the OSGi Bundle could have a BundleId child-node that maps to the getBundleId() method on the Bundle interface.

It is an error to add or delete members to a Structured node, this must be reflected in the corresponding Meta Node, that is, Structured nodes must never have the Add or Delete action.

A structured node is defined in a *structured type* to allow the reuse of the same information in different places in an object model. A structured type defines the members and their behaviors. A structured type can be referred by its name. The name of the type is often, but not required, the name of the member.

For example, a Unit structured type could look like:

Name	Act	Type	Card.	S	Description
Id	Get	long	1	P	...
URL	Get Set	string	1	P	...
Name	Get	string	1	P	...
Certificate	Get	LIST	1	P	
[index]	Get	Certificate	1	D	Note the use of a structured type.

### 117.12.9 LIST Nodes

A LIST node is an interior node representing a *collection* of elements. The elements are stored in the child nodes of the LIST node, they are called the *index nodes*. All index nodes must have the same type. The names of the index nodes are synthesized and represent the index of the index node. The first node is always named 0 and the sibling is 1, 2, etc. The sequence must be continuous and must have no missing indexes. A node name is always a string, it is therefore the responsibility of the plugin to provide the proper names. The index is assumed to be a signed positive integer limiting the LIST nodes size to Integer.MAX\_VALUE elements.

Figure 117.26 LIST Nodes

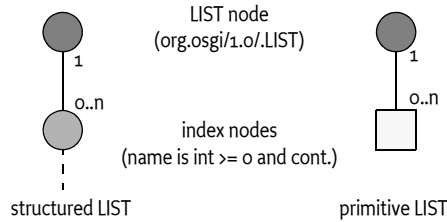

Index nodes should only be used for types where the value of the index node is the identity. For example, a network interface has an identity; a manager will expect that a node representing such as a network interface node will always have the same URI even if other interfaces are added and deleted. Since LIST nodes renumber the index node names when an element is deleted or added, the URI would fail if a network interface was added or removed. If such a case, a MAP node should be used, see *MAP Nodes* on page 525, as they allow the key to be managed by the remote manager.

LIST nodes can be mutable if the Meta Node of its index nodes support the Add or Delete action. A LIST node is modeled after a `java.util.List` that can automatically accommodate new elements. Get and Replace operations use the node name to index in this list.

To rearrange the list the local manager can Add and Delete nodes or rename them as it sees fit. At any moment in time the underlying implementation must maintain a list that runs from 0 to `max(index)` (inclusive), where `index` is the name of the LIST child nodes. Inserting a node requires renaming all subsequent nodes. Any missing indexes must automatically be provided by the plugin when the child node names are retrieved.

For example, a LIST node named L contains the following nodes:

```
L/0    A
L/1    B
L/2    C
```

To insert a node after B, L/2 must be renamed to L/3. This will automatically extend the LIST node to 4 elements. That is, even though L/2 is renamed, the implementation must automatically provide a new L/2 node. The value of this node depends on the underlying implementation. The value of the list will therefore then be: [A,B,?,C]. If node 1 is deleted, then the list will be [A,?,C]. If a node L/5 is added then the list will be [A,?,C,?,?,?]. It is usually easiest to use the LIST node as a complex value, this is discussed in the next section.

### 117.12.9.1 Complex Collections

An implementation of a LIST node must support a complex node value if its members are primitive; the interior node must then have a value of a Java object implementing the Collection interface from `java.util`. The elements in this map must be converted according to the following table.

Table 117.11 Conversion for Collections

Format	Associated Java Type
FORMAT_STRING	String
FORMAT_BOOLEAN	Boolean
FORMAT_INTEGER	Integer
FORMAT_LONG	Long
FORMAT_FLOAT	Float
FORMAT_DATE_TIME	Date
FORMAT_BINARY	byte[]



Alternatively, the Collection may contain Dmt Data objects but the collection must be homogeneous. The collection must always be a copy and changes made to the collection must not affect the DMT.

For example, a LIST type for a list of URIs could look like:

Name	Act	Type	Card.	S	Description
URIs	Get	LIST	1	P	A List of URIs
[index]	Get Set Add Del	string	0..n	D	A primitive index node

Replacing a complex value will generate a single `EVENT_TOPIC_REPLACED` event for the LIST node.

### 117.12.10 MAP Nodes

A MAP node represents a mapping from a *key* to a *value*. The key is the name of the node and the value is the node's value. A MAP node performs the same functions as a Java Map. See Figure 117.27.

Figure 117.27 MAP Nodes

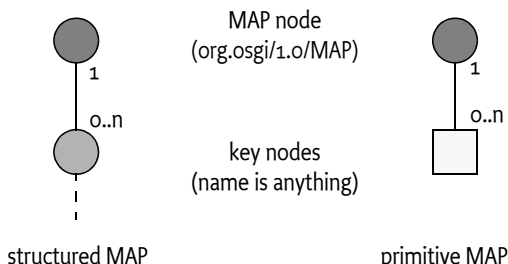

A MAP node has *key nodes* as children. A key node is an association between the name of the key node (which is the key) and the value of the key node. Key nodes are depicted with `[<type>]`, where the `<type>` indicates the type used for the string name. For example, a long type will have node names that can be converted to a long. A key type must always be one of the primitive types. For example, a list of Bundle locations can be handled with a MAP with `[string]` key nodes that have a value type of string. Since the key is used in URIs it must always be escaped, see *The DMT Addressing URI* on page 483.

For example:

Name	Act	Type	Card.	S	Description
Location	Get	MAP	1	P	A MAP of location where the index node is the Bundle Id.
[long]	Get Set Add Del	string	0..n	D	Name is the Bundle Id and the value is the location.

#### 117.12.10.1 Complex Value

An implementation of a MAP node must support an interior node value if its child nodes are primitive; the interior node must then be associated with a Java object implementing the Map interface from `java.util`. The values in this Map must homogeneous and be converted according to Table 117.11 or the given values must of type `DmtData`. The Map object must a copy and does not track changes in the DMT or vice-versa.

Replacing a complex value will generate a single `EVENT_TOPIC_REPLACED` event for that node.

### 117.12.11 Instance Id

Some protocols cannot handle arbitrary names in the access URI, they need a well defined *instance id* to index in a table or put severe restrictions on the node name's character set, length, or other aspects. For example, TR-069 can access an object with the following URI:

Device.VOIP.12.Name

The more natural model for the DMT is to use:

Device.VOIP.<Name>...

To provide assistance to these protocols this section defines a mechanism that can be used by Protocol Adapters to simplify access.

An Object Model can define a child node InstanceId. The InstanceId node, if present, holds a long value that has the following qualities:

- Its value must be between 1 and Long.MAX\_VALUE.
- No other index/key node on the same level must have the same value for the InstanceId node
- The value must be persistent between sessions and restarts of the plugin
- A value must not be reused when a node is deleted until the number space is exhausted

Protocol Adapters can use this information to provide alternative access paths for the DMT.

### 117.12.12 Conversions

Each Protocol Mapping document should define a default conversion from the Dmt Admin data formats to the protocol types and vice versa, including the LIST and MAP nodes. However, this default mapping is likely to be too constraining in real world models since different protocols support different data types and a 1:1 mapping is likely to be impossible.

For this reason, the Protocol Mapping document should define a number of protocol specific MIME types for each unique data type that they support. A Data Plugin can associate such a MIME type with a node. The Protocol Adapter can then look for this MIME type. If none of the Protocol Adapter specific MIME types are available in a node the default conversion is used.

For example, in the TR-069 Protocol Adapter specification there is a MIME type for each TR-069 data type. If for a given leaf node the Meta Node's type specifies TR069\_MIME\_UNSIGNED\_INT and the node specifies the format `FORMAT_INTEGER` then the Protocol Adapter must convert the integer to an unsigned integer and encode the value as such in the response message. The Protocol Adapter there does not have to have specific knowledge of the object model, the Plugin drives the Protocol Adapter by providing the protocol specific MIME types on the leaf node Meta Nodes. This model is depicted in Figure 117.28.

Figure 117.28 Conversions

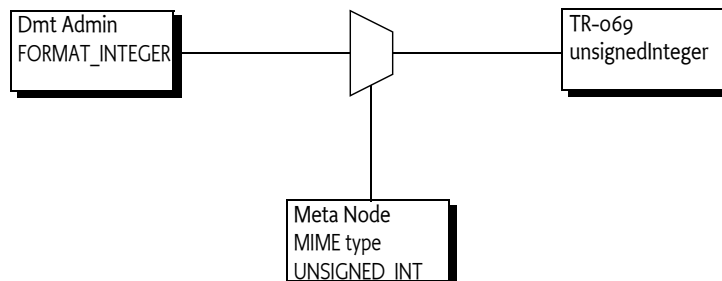

Since a Meta Node can contain multiple MIME types, there is no restrictions on the number of Protocol Adapters; a Plugin can specify the MIME types of multiple Protocol Adapters.

### 117.12.13 Extensions

All interior nodes in this specification can have a node named Ext. These nodes are the *extension* nodes. If an implementation needs to expose additional details about an interior node then they should expose these extensions under the corresponding Ext node. To reduce name conflicts, it is recommended to group together implementation specific extensions under a unique name, recommended is to use the reverse domain name. For example, the following DDF defines an Ext node with extensions for the ACME provider.

Name	Act	Type	Card.	S	Description
Framework	Get	Framework	1	P	...
Ext	Get		1	P	Extension node
com.acme	Get	AcmeFrameworkExt	1	P	The node for the ACME extensions
Transactional	Get	boolean	1	P	...

## 117.13 Security

A key aspect of the Dmt Admin service model is the separation from DMT clients and plugins. The Dmt Admin service receives all the operation requests and, after verification of authority, forwards the requests to the plugins.

Figure 117.29 Separation of clients and plugins

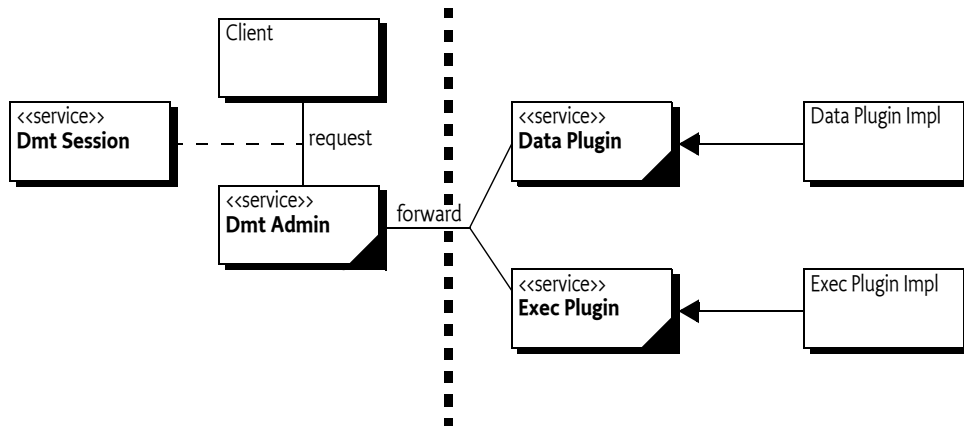

This architecture makes it straightforward to use the OSGi security architecture to protect the different actors.

### 117.13.1 Principals

The caller of the `getSession(String,String,int)` method must have the Dmt Principal Permission with a target that matches the given principal. This Dmt Principal Permission is used to enforce that only trusted entities can act on behalf of remote managers.

The Dmt Admin service must verify that all operations from a session with a principal can be executed on the given nodes using the available ACLs.

The other two forms of the `getSession` method are meant for local management applications where no principal is available. No special permission is defined to restrict the usage of these methods. The callers that want to execute device management commands, however, need to have the appropriate Dmt Permissions.

### 117.13.2 Operational Permissions

The operational security of a Local Manager and a remote manager is distinctly different. The distinction is made on the principal. Protocol Adapters should use the `getSession` method that takes an authenticated principal. Local Managers should not specify a principal.

Figure 117.30 Access control context, for Local Manager and Protocol Adapter operation

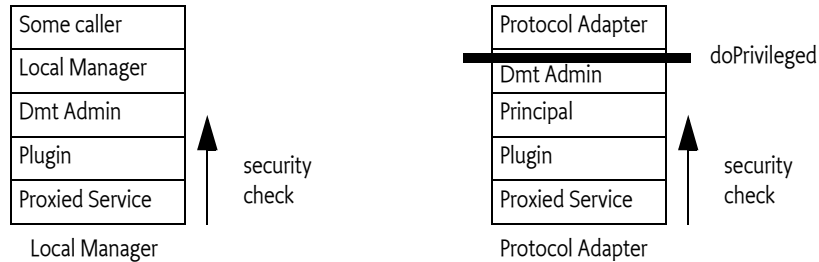

### 117.13.3 Protocol Adapters

A Protocol Adapter must provide a principal to the Dmt Admin service when it gets a session. It must use the `getSession(String,String,int)` method. The Protocol Adapter must have Dmt Principal Permission for the given principal. The Dmt Admin service must then use this principal to determine the *security scope* of the given principal. This security scope is a set of permissions. How these permissions are found is not defined in this specification; they are usually in the management tree of a device. For example, the Mobile Specification stores these under the `$/Policy/Java/DmtPrincipalPermission` sub-tree.

Additionally, a Dmt Session with a principal implies that the Dmt Admin service must verify the ACLs on the node for all operations.

Any operation that is requested by a Protocol Adapter must be executed in a `doPrivileged` block that takes the principal's security scope. The `doPrivileged` block effectively hides the permissions of the Protocol Adapter; all operations must be performed under the security scope of the principal.

The security check for a Protocol Adapter is therefore as follows:

- The operation method calls `doPrivileged` with the security scope of the principal.
- The operation is forwarded to the appropriate plugin. The underlying service must perform its normal security checks. For example, the Configuration Admin service must check for the appropriate Configuration Permission.

The Access Control context is shown in Figure 117.30 within the Protocol Adapter column.

This principal-based security model allows for minimal permissions on the Protocol Adapter, because the Dmt Admin service performs a `doPrivileged` on behalf of the principal, inserting the permissions for the principal on the call stack. This model does not guard against malicious Protocol Adapters, though the Protocol Adapter must have the appropriate Dmt Principal Permission.

The Protocol Adapter is responsible for the authentication of the principal. The Dmt Admin service must trust that the Protocol Adapter has correctly verified the identity of the other party. This specification does not address the type of authentication mechanisms that can be used. Once it has permission to use that principal, it can use any DMT command that is permitted for that principal at any time.

### 117.13.4 Local Manager

A Local Manager does not specify a principal. Security checks are therefore performed against the security scope of the Local Manager bundle, as shown in Figure 117.30 with the Local Manager stack. An operation is checked only with a Dmt Permission for the given node URI and operation. A

thrown Security Exception must be passed unmodified to the caller of the operation method. The Dmt Admin service must not check the ACLs when no principal is set.

A Local Manager, and all its callers, must therefore have sufficient permission to handle the DMT operations as well as the permissions required by the plugins when they proxy other services (which is likely an extensive set of Permissions).

### 117.13.5 Plugin Security

Plugins are required to hold the maximum security scope for any services they proxy. For example, the plugin that manages the Configuration Admin service must have ConfigurationPermission("\*","\*") to be effective.

Plugins should not make doPrivileged calls, but should use the caller's context on the stack for permission checks.

### 117.13.6 Events and Permissions

Dmt Event Listener services must have the appropriate Dmt Permission to receive the event since this must be verified with the hasPermission() method on Bundle.

The Dmt Event Listener services registered with a FILTER\_PRINCIPAL service property requires Dmt Principal Permission for the given principal. In this case, the principal must have Get access to see the nodes for the event. Any nodes that the listener does not have access to must be removed from the event.

Plugins are not required to have access to the Event Admin service. If they send an event through the MountPoint interface then the Dmt Admin service must use a doPrivileged block to send the event to the Event Admin service.

### 117.13.7 Dmt Principal Permission

Execution of the getSession methods of the Dmt Admin service featuring an explicit principal name is guarded by the Dmt Principal Permission. This permission must be granted only to Protocol Adapters that open Dmt Sessions on behalf of remote management servers.

The DmtPrincipalPermission class does not have defined actions; it must always be created with a \* to allow future extensions. The target is the principal name. A wildcard character is allowed at the end of the string to match a prefix.

Example:

```
new DmtPrincipalPermission("com.acme.dep*", "*" )
```

### 117.13.8 Dmt Permission

The Dmt Permission controls access to management objects in the DMT. It is intended to control only the local access to the DMT. The Dmt Permission target string identifies the target node's URI (absolute path is required, starting with the './' prefix) and the action field lists the management commands that are permitted on the node.

The URI can end in a wildcard character \* to indicate it is a prefix that must be matched. This comparison is string based so that node boundaries can be ignored.

The following actions are defined:

- ADD
- DELETE
- EXEC
- GET
- REPLACE

For example, the following code creates a Dmt Permission for a bundle to add and replace nodes in any URI that starts with `./D`.

```
new DmtPermission("./D*", "Add,Replace")
```

This permission must imply the following permission:

```
new DmtPermission("./Dev/Operator/Name", "Replace")
```

### 117.13.9 Alert Permission

The Alert Permission permits the holder of this permission to send a notification to a specific *target principal*. The target is identical to *Dmt Principal Permission* on page 529. No actions are defined for Alert Permission.

## 117.13.10 Security Summary

### 117.13.10.1 Dmt Admin Service and Notification Service

The Dmt Admin service is likely to require All Permission. This requirement is caused by the plugin model. Any permission required by any of the plugins must be granted to the Dmt Admin service. This set of permissions is large and hard to define. The following list shows the minimum permissions required if the plugin permissions are left out.

ServicePermission	..DmtAdmin	REGISTER
ServicePermission	..NotificationService	REGISTER
ServicePermission	..DataPlugin	GET
ServicePermission	..ExecPlugin	GET
ServicePermission	..EventAdmin	GET
ServicePermission	..RemoteAlertSender	GET
ServicePermission	..DmtEventListener	GET
DmtPermission	*	*
DmtPrincipalPermission	*	*
PackagePermission	org.osgi.service.dmt	EXPORTONLY
PackagePermission	org.osgi.service.dmt.spi	EXPORTONLY
PackagePermission	org.osgi.service.dmt.notification	EXPORTONLY
PackagePermission	org.osgi.service.dmt.notification.spi	EXPORTONLY
PackagePermission	org.osgi.service.dmt.registry	EXPORTONLY
PackagePermission	org.osgi.service.dmt.security	EXPORTONLY

### 117.13.10.2 Dmt Event Listener Service

ServicePermission	..DmtEventListener	REGISTER
PackagePermission	org.osgi.service.dmt	IMPORT

Dmt Event Listeners must have the appropriate DmtPermission to see the nodes in the events. If they are registered with a principal then they also need DmtPrincipalPermission for the given principals.

### 117.13.10.3 Data and Exec Plugin

ServicePermission	..NotificationService	GET
ServicePermission	..DataPlugin	REGISTER
ServicePermission	..ExecPlugin	REGISTER
PackagePermission	org.osgi.service.dmt	IMPORT
PackagePermission	org.osgi.service.dmt.notification	IMPORT
PackagePermission	org.osgi.service.dmt.spi	IMPORT
PackagePermission	org.osgi.service.dmt.security	IMPORT

The plugin is also required to have any permissions to call its underlying services.

**117.13.10.4 Local Manager**

ServicePermission	..DmtAdmin	GET
PackagePermission	org.osgi.service.dmt	IMPORT
PackagePermission	org.osgi.service.dmt.security	IMPORT
DmtPermission	<scope>	...

Additionally, the Local Manager requires all permissions that are needed by the plugins it addresses.

**117.13.10.5 Protocol Adapter**

The Protocol Adapter only requires Dmt Principal Permission for the instances that it is permitted to manage. The other permissions are taken from the security scope of the principal.

ServicePermission	..DmtAdmin	GET
ServicePermission	..RemoteAlertSender	REGISTER
PackagePermission	org.osgi.service.dmt	IMPORT
PackagePermission	org.osgi.service.dmt.notification.spi	IMPORT
PackagePermission	org.osgi.service.dmt.notification	IMPORT
DmtPrincipalPermission	<scope>	

**117.14 org.osgi.service.dmt**

Device Management Tree Package Version 2.0.

This package contains the public API for the Device Management Tree manipulations. Permission classes are provided by the org.osgi.service.dmt.security package, and DMT plugin interfaces can be found in the org.osgi.service.dmt.spi package. Asynchronous notifications to remote management servers can be sent using the interfaces in the org.osgi.service.dmt.notification package.

Bundles wishing to use this package must list the package in the Import-Package header of the bundle's manifest. This package has two types of users: the consumers that use the API in this package and the providers that implement the API in this package.

Example import for consumers using the API in this package:

```
Import-Package: org.osgi.service.dmt; version="[2.0,3.0]"
```

Example import for providers implementing the API in this package:

```
Import-Package: org.osgi.service.dmt; version="[2.0,2.1]"
```

**117.14.1 Summary**

- Acl - Acl is an immutable class representing structured access to DMT ACLs.
- DmtAdmin - An interface providing methods to open sessions and register listeners.
- DmtConstants - Defines standard names for DmtAdmin.
- DmtData - An immutable data structure representing the contents of a leaf or interior node.
- DmtEvent - Event class storing the details of a change in the tree.
- DmtEventListener - Registered implementations of this class are notified via DmtEvent objects about important changes in the tree.
- DmtException - Checked exception received when a DMT operation fails.
- DmtIllegalStateException - Unchecked illegal state exception.
- DmtSession - DmtSession provides concurrent access to the DMT.
- MetaNode - The MetaNode contains meta data as standardized by OMA DM but extends it (without breaking the compatibility) to provide for better DMT data quality in an environment where many software components manipulate this data.

- `Uri` - This class contains static utility methods to manipulate DMT URIs.

### 117.14.2 **public final class Acl**

`Acl` is an immutable class representing structured access to DMT ACLs. Under OMA DM the ACLs are defined as strings with an internal syntax.

The methods of this class taking a principal as parameter accept remote server IDs (as passed to `DmtAdmin.getSession()`), as well as "\*" indicating any principal.

The syntax for valid remote server IDs:

`<server-identifier> ::=` All printable characters except '=', '&', '\*', '+', or white-space characters.

#### 117.14.2.1 **public static final int ADD = 2**

Principals holding this permission can issue ADD commands on the node having this ACL.

#### 117.14.2.2 **public static final int ALL\_PERMISSION = 31**

Principals holding this permission can issue any command on the node having this ACL. This permission is the logical OR of ADD, DELETE, EXEC, GET and REPLACE permissions.

#### 117.14.2.3 **public static final int DELETE = 8**

Principals holding this permission can issue DELETE commands on the node having this ACL.

#### 117.14.2.4 **public static final int EXEC = 16**

Principals holding this permission can issue EXEC commands on the node having this ACL.

#### 117.14.2.5 **public static final int GET = 1**

Principals holding this permission can issue GET command on the node having this ACL.

#### 117.14.2.6 **public static final int REPLACE = 4**

Principals holding this permission can issue REPLACE commands on the node having this ACL.

#### 117.14.2.7 **public Acl(String acl)**

*acl* The string representation of the ACL as defined in OMA DM. If null or empty then it represents an empty list of principals with no permissions.

- Create an instance of the ACL from its canonical string representation.

*Throws* `IllegalArgumentException`— if *acl* is not a valid OMA DM ACL string

#### 117.14.2.8 **public Acl(String[] principals,int[] permissions)**

*principals* The array of principals

*permissions* The array of permissions

- Creates an instance with a specified list of principals and the permissions they hold. The two arrays run in parallel, that is `principals[i]` will hold `permissions[i]` in the ACL.

A principal name may not appear multiple times in the 'principals' argument. If the "\*" principal appears in the array, the corresponding permissions will be granted to all principals (regardless of whether they appear in the array or not).

*Throws* `IllegalArgumentException`— if the length of the two arrays are not the same, if any array element is invalid, or if a principal appears multiple times in the principals array

#### 117.14.2.9 **public synchronized Acl addPermission(String principal,int permissions)**

*principal* The entity to which permissions should be granted, or "\*" to grant permissions to all principals.



*permissions* The permissions to be given. The parameter can be a logical or of more permission constants defined in this class.

- Create a new Acl instance from this Acl with the given permission added for the given principal. The already existing permissions of the principal are not affected.

*Returns* a new Acl instance

*Throws* `IllegalArgumentException`— if principal is not a valid principal name or if permissions is not a valid combination of the permission constants defined in this class

#### **117.14.2.10      public synchronized Acl deletePermission(String principal,int permissions)**

*principal* The entity from which permissions should be revoked, or "\*" to revoke permissions from all principals.

*permissions* The permissions to be revoked. The parameter can be a logical or of more permission constants defined in this class.

- Create a new Acl instance from this Acl with the given permission revoked from the given principal. Other permissions of the principal are not affected.

Note, that it is not valid to revoke a permission from a specific principal if that permission is granted globally to all principals.

*Returns* a new Acl instance

*Throws* `IllegalArgumentException`— if principal is not a valid principal name, if permissions is not a valid combination of the permission constants defined in this class, or if a globally granted permission would have been revoked from a specific principal

#### **117.14.2.11      public boolean equals(Object obj)**

*obj* the object to compare with this Acl instance

- Checks whether the given object is equal to this Acl instance. Two Acl instances are equal if they allow the same set of permissions for the same set of principals.

*Returns* true if the parameter represents the same ACL as this instance

#### **117.14.2.12      public synchronized int getPermissions(String principal)**

*principal* The entity whose permissions to query, or "\*" to query the permissions that are granted globally, to all principals

- Get the permissions associated to a given principal.

*Returns* The permissions of the given principal. The returned int is a bitmask of the permission constants defined in this class

*Throws* `IllegalArgumentException`— if principal is not a valid principal name

#### **117.14.2.13      public String[] getPrincipals()**

- Get the list of principals who have any kind of permissions on this node. The list only includes those principals that have been explicitly assigned permissions (so "\*" is never returned), globally set permissions naturally apply to all other principals as well.

*Returns* The array of principals having permissions on this node.

#### **117.14.2.14      public int hashCode()**

- Returns the hash code for this ACL instance. If two Acl instances are equal according to the `equals(Object)` method, then calling this method on each of them must produce the same integer result.

*Returns* hash code for this ACL

**117.14.2.15 public synchronized boolean isPermitted(String principal,int permissions)**

*principal* The entity to check, or "\*" to check whether the given permissions are granted to all principals globally

*permissions* The permissions to check

- Check whether the given permissions are granted to a certain principal. The requested permissions are specified as a bitfield, for example (Acl.ADD | Acl.DELETE | Acl.GET).

*Returns* true if the principal holds all the given permissions

*Throws* IllegalArgumentException– if principal is not a valid principal name or if permissions is not a valid combination of the permission constants defined in this class

**117.14.2.16 public synchronized Acl setPermission(String principal,int permissions)**

*principal* The entity to which permissions should be granted, or "\*" to globally grant permissions to all principals.

*permissions* The set of permissions to be given. The parameter is a bitmask of the permission constants defined in this class.

- Create a new Acl instance from this Acl where all permissions for the given principal are overwritten with the given permissions.

Note, that when changing the permissions of a specific principal, it is not allowed to specify a set of permissions stricter than the global set of permissions (that apply to all principals).

*Returns* a new Acl instance

*Throws* IllegalArgumentException– if principal is not a valid principal name, if permissions is not a valid combination of the permission constants defined in this class, or if a globally granted permission would have been revoked from a specific principal

**117.14.2.17 public synchronized String toString()**

- Give the canonical string representation of this ACL. The operations are in the following order: {Add, Delete, Exec, Get, Replace}, principal names are sorted alphabetically.

*Returns* The string representation as defined in OMA DM.

**117.14.3 public interface DmtAdmin**

An interface providing methods to open sessions and register listeners. The implementation of DmtAdmin should register itself in the OSGi service registry as a service. DmtAdmin is the entry point for applications to use the DMT API.

The getSession methods are used to open a session on a specified subtree of the DMT. A typical way of usage:

```
serviceRef = context.getServiceReference(DmtAdmin.class.getName());
DmtAdmin admin = (DmtAdmin) context.getService(serviceRef);
DmtSession session = admin.getSession("/OSGi/Configuration");
session.createInteriorNode("/OSGi/Configuration/my.table");
```

The methods for opening a session take a node URI (the session root) as a parameter. All segments of the given URI must be within the segment length limit of the implementation, and the special characters '/' and '\' must be escaped (preceded by a '\').

See the Uri.encode(String) method for support on escaping invalid characters in a URI.

It is possible to specify a lock mode when opening the session (see lock type constants in DmtSession). This determines whether the session can run in parallel with other sessions, and the kinds of operations that can be performed in the session. All Management Objects constituting the device

management tree must support read operations on their nodes, while support for write operations depends on the Management Object. Management Objects supporting write access may support transactional write, non-transactional write or both. Users of DmtAdmin should consult the Management Object specification and implementation for the supported update modes. If Management Object definition permits, implementations are encouraged to support both update modes.

#### 117.14.3.1 **public DmtSession getSession(String subtreeUri) throws DmtException**

*subtreeUri* the subtree on which DMT manipulations can be performed within the returned session

- Opens a DmtSession for local usage on a given subtree of the DMT with non transactional write lock. This call is equivalent to the following: `getSession(null, subtreeUri, DmtSession.LOCK_TYPE_EXCLUSIVE)`

The *subtreeUri* parameter must contain an absolute URI. It can also be null, in this case the session is opened with the default session root, ".", that gives access to the whole tree.

To perform this operation the caller must have DmtPermission for the *subtreeUri* node with the Get action present.

*Returns* a DmtSession object for the requested subtree

*Throws* DmtException– with the following possible error codes:

- INVALID\_URI if *subtreeUri* is syntactically invalid
- URI\_TOO\_LONG if *subtreeUri* is longer than accepted by the DmtAdmin implementation (especially on systems with limited resources)
- NODE\_NOT\_FOUND if *subtreeUri* specifies a non-existing node
- SESSION\_CREATION\_TIMEOUT if the operation timed out because of another ongoing session
- COMMAND\_FAILED if *subtreeUri* specifies a relative URI, or some unspecified error is encountered while attempting to complete the command

SecurityException– if the caller does not have DmtPermission for the given root node with the Get action present

#### 117.14.3.2 **public DmtSession getSession(String subtreeUri,int lockMode) throws DmtException**

*subtreeUri* the subtree on which DMT manipulations can be performed within the returned session

*lockMode* one of the lock modes specified in DmtSession

- Opens a DmtSession for local usage on a specific DMT subtree with a given lock mode. This call is equivalent to the following: `getSession(null, subtreeUri, lockMode)`

The *subtreeUri* parameter must contain an absolute URI. It can also be null, in this case the session is opened with the default session root, ".", that gives access to the whole tree.

To perform this operation the caller must have DmtPermission for the *subtreeUri* node with the Get action present.

*Returns* a DmtSession object for the requested subtree

*Throws* DmtException– with the following possible error codes:

- INVALID\_URI if *subtreeUri* is syntactically invalid
- URI\_TOO\_LONG if *subtreeUri* is longer than accepted by the DmtAdmin implementation (especially on systems with limited resources)
- NODE\_NOT\_FOUND if *subtreeUri* specifies a non-existing node
- FEATURE\_NOT\_SUPPORTED if atomic sessions are not supported by the implementation and *lockMode* requests an atomic session
- SESSION\_CREATION\_TIMEOUT if the operation timed out because of another ongoing session

- `COMMAND_FAILED` if `subtreeUri` specifies a relative URI, if `lockMode` is unknown, or some unspecified error is encountered while attempting to complete the command

`SecurityException`— if the caller does not have `DmtPermission` for the given root node with the `Get` action present

### 117.14.3.3 **public DmtSession getSession(String principal,String subtreeUri,int lockMode) throws DmtException**

*principal* the identifier of the remote server on whose behalf the data manipulation is performed, or null for local sessions

*subtreeUri* the subtree on which DMT manipulations can be performed within the returned session

*lockMode* one of the lock modes specified in `DmtSession`

- Opens a `DmtSession` on a specific DMT subtree using a specific lock mode on behalf of a remote principal. If local management applications are using this method then they should provide null as the first parameter. Alternatively they can use other forms of this method without providing a principal string.

The `subtreeUri` parameter must contain an absolute URI. It can also be null, in this case the session is opened with the default session root, ".", that gives access to the whole tree.

This method is guarded by `DmtPrincipalPermission` in case of remote sessions. In addition, the caller must have `Get` access rights (ACL in case of remote sessions, `DmtPermission` in case of local sessions) on the `subtreeUri` node to perform this operation.

*Returns* a `DmtSession` object for the requested subtree

*Throws* `DmtException`— with the following possible error codes:

- `INVALID_URI` if `subtreeUri` is syntactically invalid
- `URI_TOO_LONG` if `subtreeUri` is longer than accepted by the `DmtAdmin` implementation (especially on systems with limited resources)
- `NODE_NOT_FOUND` if `subtreeUri` specifies a non-existing node
- `PERMISSION_DENIED` if `principal` is not null and the ACL of the node does not allow the `Get` operation for the principal on the given root node
- `FEATURE_NOT_SUPPORTED` if atomic sessions are not supported by the implementation and `lockMode` requests an atomic session
- `SESSION_CREATION_TIMEOUT` if the operation timed out because of another ongoing session
- `COMMAND_FAILED` if `subtreeUri` specifies a relative URI, if `lockMode` is unknown, or some unspecified error is encountered while attempting to complete the command

`SecurityException`— in case of remote sessions, if the caller does not have the required `DmtPrincipalPermission` with a target matching the `principal` parameter, or in case of local sessions, if the caller does not have `DmtPermission` for the given root node with the `Get` action present

### 117.14.4 **public class DmtConstants**

Defines standard names for `DmtAdmin`.

*Since* 2.0

#### 117.14.4.1 **public static final String DDF\_LIST = "org.osgi/1.0/LIST"**

A string defining a DDF URI, indicating that the node is a LIST node.

#### 117.14.4.2 **public static final String DDF\_MAP = "org.osgi/1.0/MAP"**

A string defining a DDF URI, indicating that the node is a MAP node.

- 117.14.4.3**      **public static final String DDF\_SCAFFOLD = "org.osgi/1.0/SCAFFOLD"**  
A string defining a DDF URI, indicating that the node is a SCAFFOLD node.
- 117.14.4.4**      **public static final String EVENT\_PROPERTY\_NEW\_NODES = "newnodes"**  
A string defining the property key for the newnodes property in node related events.
- 117.14.4.5**      **public static final String EVENT\_PROPERTY\_NODES = "nodes"**  
A string defining the property key for the @code nodes property in node related events.
- 117.14.4.6**      **public static final String EVENT\_PROPERTY\_SESSION\_ID = "session.id"**  
A string defining the property key for the session.id property in node related events.
- 117.14.4.7**      **public static final String EVENT\_TOPIC\_ADDED = "org/osgi/service/dmt/DmtEvent/ADDED"**  
A string defining the topic for the event that is sent for added nodes.
- 117.14.4.8**      **public static final String EVENT\_TOPIC\_COPIED = "org/osgi/service/dmt/DmtEvent/COPIED"**  
A string defining the topic for the event that is sent for copied nodes.
- 117.14.4.9**      **public static final String EVENT\_TOPIC\_DELETED = "org/osgi/service/dmt/DmtEvent/DELETED"**  
A string defining the topic for the event that is sent for deleted nodes.
- 117.14.4.10**     **public static final String EVENT\_TOPIC\_RENAMED = "org/osgi/service/dmt/DmtEvent/RENAMED"**  
A string defining the topic for the event that is sent for renamed nodes.
- 117.14.4.11**     **public static final String EVENT\_TOPIC\_REPLACED = "org/osgi/service/dmt/DmtEvent/REPLACED"**  
A string defining the topic for the event that is sent for replaced nodes.
- 117.14.4.12**     **public static final String EVENT\_TOPIC\_SESSION\_CLOSED = "org/osgi/service/dmt/DmtEvent/SESSION\_CLOSED"**  
A string defining the topic for the event that is sent for a closed session.
- 117.14.4.13**     **public static final String EVENT\_TOPIC\_SESSION\_OPENED = "org/osgi/service/dmt/DmtEvent/SESSION\_OPENED"**  
A string defining the topic for the event that is sent for a newly opened session.

### **117.14.5**      **public final class DmtData**

An immutable data structure representing the contents of a leaf or interior node. This structure represents only the value and the format property of the node, all other properties (like MIME type) can be set and read using the DmtSession interface.

Different constructors are available to create nodes with different formats. Nodes of null format can be created using the static NULL\_VALUE constant instance of this class.

FORMAT\_RAW\_BINARY and FORMAT\_RAW\_STRING enable the support of future data formats. When using these formats, the actual format name is specified as a String. The application is responsible for the proper encoding of the data according to the specified format.

*Concurrency* Immutable

- 117.14.5.1**      **public static final DmtData FALSE\_VALUE**  
Constant instance representing a boolean false value.

*Since* 2.0

- 117.14.5.2**      **public static final int FORMAT\_BASE64 = 128**
- The node holds an OMA DM b64 value. Like FORMAT\_BINARY, this format is also represented by the Java byte[] type, the difference is only in the corresponding OMA DM format. This format does not affect the internal storage format of the data as byte[]. It is intended as a hint for the external representation of this data. Protocol Adapters can use this hint for their further processing.
- 117.14.5.3**      **public static final int FORMAT\_BINARY = 64**
- The node holds an OMA DM bin value. The value of the node corresponds to the Java byte[] type.
- 117.14.5.4**      **public static final int FORMAT\_BOOLEAN = 8**
- The node holds an OMA DM bool value.
- 117.14.5.5**      **public static final int FORMAT\_DATE = 16**
- The node holds an OMA DM date value.
- 117.14.5.6**      **public static final int FORMAT\_DATE\_TIME = 16384**
- The node holds a Date object. If the getTime() equals zero then the date time is not known. If the getTime() is negative it must be interpreted as a relative number of milliseconds.
- Since* 2.0
- 117.14.5.7**      **public static final int FORMAT\_FLOAT = 2**
- The node holds an OMA DM float value.
- 117.14.5.8**      **public static final int FORMAT\_INTEGER = 1**
- The node holds an OMA DM int value.
- 117.14.5.9**      **public static final int FORMAT\_LONG = 8192**
- The node holds a long value. The getFormatName() method can be used to get the actual format name.
- Since* 2.0
- 117.14.5.10**     **public static final int FORMAT\_NODE = 1024**
- Format specifier of an internal node. An interior node can hold a Java object as value (see DmtData.DmtData(Object) and DmtData.getNode()). This value can be used by Java programs that know a specific URI understands the associated Java type. This type is further used as a return value of the MetaNode.getFormat() method for interior nodes.
- 117.14.5.11**     **public static final int FORMAT\_NULL = 512**
- The node holds an OMA DM null value. This corresponds to the Java null type.
- 117.14.5.12**     **public static final int FORMAT\_RAW\_BINARY = 4096**
- The node holds raw protocol data encoded in binary format. The getFormatName() method can be used to get the actual format name.
- 117.14.5.13**     **public static final int FORMAT\_RAW\_STRING = 2048**
- The node holds raw protocol data encoded as String. The getFormatName() method can be used to get the actual format name.
- 117.14.5.14**     **public static final int FORMAT\_STRING = 4**
- The node holds an OMA DM chr value.

- 117.14.5.15**      **public static final int FORMAT\_TIME = 32**  
The node holds an OMA DM time value.
- 117.14.5.16**      **public static final int FORMAT\_XML = 256**  
The node holds an OMA DM xml value.
- 117.14.5.17**      **public static final DmtData NULL\_VALUE**  
Constant instance representing a leaf node of null format.
- 117.14.5.18**      **public static final DmtData TRUE\_VALUE**  
Constant instance representing a boolean true value.
- Since* 2.0
- 117.14.5.19**      **public DmtData(String string)**  
*string* the string value to set
- Create a DmtData instance of chr format with the given string value. The null string argument is valid.
- 117.14.5.20**      **public DmtData(Date date)**  
*date* the Date object to set
- Create a DmtData instance of dateTime format with the given Date value. The given Date value must be a non-null Date object.
- 117.14.5.21**      **public DmtData(Object complex)**  
*complex* the complex data object to set
- Create a DmtData instance of node format with the given object value. The value represents complex data associated with an interior node.
- Certain interior nodes can support access to their subtrees through such complex values, making it simpler to retrieve or update all leaf nodes in a subtree.
- The given value must be a non-null immutable object.
- 117.14.5.22**      **public DmtData(String value,int format)**  
*value* the string, XML, date, or time value to set  
*format* the format of the DmtData instance to be created, must be one of the formats specified above
- Create a DmtData instance of the specified format and set its value based on the given string. Only the following string-based formats can be created using this constructor:
    - FORMAT\_STRING - value can be any string
    - FORMAT\_XML - value must contain an XML fragment (the validity is not checked by this constructor)
    - FORMAT\_DATE - value must be parsable to an ISO 8601 calendar date in complete representation, basic format (pattern CCYYMMDD)
    - FORMAT\_TIME - value must be parsable to an ISO 8601 time of day in either local time, complete representation, basic format (pattern hhmmss) or Coordinated Universal Time, basic format (pattern hhmmssZ)
- \* The null string argument is only valid if the format is string or XML.
- Throws* IllegalArgumentException – if format is not one of the allowed formats, or value is not a valid string for the given format

NullPointerException– if a string, XML, date, or time is constructed and value is null

**117.14.5.23 public DmtData(int integer)**

*integer* the integer value to set

- Create a DmtData instance of int format and set its value.

**117.14.5.24 public DmtData(float flt)**

*flt* the float value to set

- Create a DmtData instance of float format and set its value.

**117.14.5.25 public DmtData(long lng)**

*lng* the long value to set

- Create a DmtData instance of long format and set its value.

*Since* 2.0

**117.14.5.26 public DmtData(boolean bool)**

*bool* the boolean value to set

- Create a DmtData instance of bool format and set its value.

**117.14.5.27 public DmtData(byte[] bytes)**

*bytes* the byte array to set, must not be null

- Create a DmtData instance of bin format and set its value.

*Throws* NullPointerException– if bytes is null

**117.14.5.28 public DmtData(byte[] bytes,boolean base64)**

*bytes* the byte array to set, must not be null

*base64* if true, the new instance will have b64 format, if false, it will have bin format

- Create a DmtData instance of bin or b64 format and set its value. The chosen format is specified by the base64 parameter.

*Throws* NullPointerException– if bytes is null

**117.14.5.29 public DmtData(byte[] bytes,int format)**

*bytes* the byte array to set, must not be null

*format* the format of the DmtData instance to be created, must be one of the formats specified above

- Create a DmtData instance of the specified format and set its value based on the given byte[]. Only the following byte[] based formats can be created using this constructor:

- FORMAT\_BINARY
- FORMAT\_BASE64

*Throws* IllegalArgumentException– if format is not one of the allowed formats

NullPointerException– if bytes is null

**117.14.5.30 public DmtData(String formatName,String data)**

*formatName* the name of the format, must not be null

*data* the data encoded according to the specified format, must not be null



- Create a DmtData instance in FORMAT\_RAW\_STRING format. The data is provided encoded as a String. The actual data format is specified in formatName. The encoding used in data must conform to this format.

*Throws* NullPointerException– if formatName or data is null

**117.14.5.31      public DmtData(String formatName,byte[] data)**

*formatName* the name of the format, must not be null

*data* the data encoded according to the specified format, must not be null

- Create a DmtData instance in FORMAT\_RAW\_BINARY format. The data is provided encoded as binary. The actual data format is specified in formatName. The encoding used in data must conform to this format.

*Throws* NullPointerException– if formatName or data is null

**117.14.5.32      public boolean equals(Object obj)**

*obj* the object to compare with this DmtData

- Compares the specified object with this DmtData instance. Two DmtData objects are considered equal if their format is the same, and their data (selected by the format) is equal.

In case of FORMAT\_RAW\_BINARY and FORMAT\_RAW\_STRING the textual name of the data format - as returned by getFormatName() - must be equal as well.

*Returns* true if the argument represents the same DmtData as this object

**117.14.5.33      public byte[] getBase64()**

- Gets the value of a node with base 64 (b64) format.

*Returns* the binary value

*Throws* DmtIllegalStateException– if the format of the node is not base 64.

**117.14.5.34      public byte[] getBinary()**

- Gets the value of a node with binary (bin) format.

*Returns* the binary value

*Throws* DmtIllegalStateException– if the format of the node is not binary

**117.14.5.35      public boolean getBoolean()**

- Gets the value of a node with boolean (bool) format.

*Returns* the boolean value

*Throws* DmtIllegalStateException– if the format of the node is not boolean

**117.14.5.36      public String getDate()**

- Gets the value of a node with date format. The returned date string is formatted according to the ISO 8601 definition of a calendar date in complete representation, basic format (pattern CCYYMMDD).

*Returns* the date value

*Throws* DmtIllegalStateException– if the format of the node is not date

**117.14.5.37      public Date getDateTime()**

- Gets the value of a node with dateTime format.

*Returns* the Date value

*Throws* DmtIllegalStateException– if the format of the node is not time

*Since* 2.0

**117.14.5.38      public float getFloat()**

- Gets the value of a node with float format.

*Returns* the float value

*Throws* DmtIllegalStateException– if the format of the node is not float

**117.14.5.39      public int getFormat()**

- Get the node's format, expressed in terms of type constants defined in this class. Note that the 'format' term is a legacy from OMA DM, it is more customary to think of this as 'type'.

*Returns* the format of the node

**117.14.5.40      public String getFormatName()**

- Returns the format of this DmtData as String. For the predefined data formats this is the OMA DM defined name of the format. For FORMAT\_RAW\_STRING and FORMAT\_RAW\_BINARY this is the format specified when the object was created.

*Returns* the format name as String

**117.14.5.41      public int getInt()**

- Gets the value of a node with integer (int) format.

*Returns* the integer value

*Throws* DmtIllegalStateException– if the format of the node is not integer

**117.14.5.42      public long getLong()**

- Gets the value of a node with long format.

*Returns* the long value

*Throws* DmtIllegalStateException– if the format of the node is not long

*Since* 2.0

**117.14.5.43      public Object getNode()**

- Gets the complex data associated with an interior node (node format).

Certain interior nodes can support access to their subtrees through complex values, making it simpler to retrieve or update all leaf nodes in the subtree.

*Returns* the data object associated with an interior node

*Throws* DmtIllegalStateException– if the format of the data is not node

**117.14.5.44      public byte[] getRawBinary()**

- Gets the value of a node in raw binary (FORMAT\_RAW\_BINARY) format.

*Returns* the data value in raw binary format

*Throws* DmtIllegalStateException– if the format of the node is not raw binary

**117.14.5.45      public String getRawString()**

- Gets the value of a node in raw String (FORMAT\_RAW\_STRING) format.

*Returns* the data value in raw String format

*Throws* DmtIllegalStateException– if the format of the node is not raw String

**117.14.5.46      public int getSize()**

- Get the size of the data. The returned value depends on the format of data in the node:
  - FORMAT\_STRING, FORMAT\_XML, FORMAT\_BINARY, FORMAT\_BASE64, FORMAT\_RAW\_STRING, and FORMAT\_RAW\_BINARY: the length of the stored data, or 0 if the data is null
  - FORMAT\_INTEGER and FORMAT\_FLOAT: 4
  - FORMAT\_LONG and FORMAT\_DATE\_TIME: 8
  - FORMAT\_DATE and FORMAT\_TIME: the length of the date or time in its string representation
  - FORMAT\_BOOLEAN: 1
  - FORMAT\_NODE: -1 (unknown)
  - FORMAT\_NULL: 0

*Returns* the size of the data stored by this object

**117.14.5.47      public String getString()**

- Gets the value of a node with string (chr) format.

*Returns* the string value

*Throws* DmtIllegalStateException– if the format of the node is not string

**117.14.5.48      public String getTime()**

- Gets the value of a node with time format. The returned time string is formatted according to the ISO 8601 definition of the time of day. The exact format depends on the value the object was initialized with: either local time, complete representation, basic format (pattern h:mm:ss ) or Coordinated Universal Time, basic format (pattern h:mm:ssZ).

*Returns* the time value

*Throws* DmtIllegalStateException– if the format of the node is not time

**117.14.5.49      public String getXml()**

- Gets the value of a node with xml format.

*Returns* the XML value

*Throws* DmtIllegalStateException– if the format of the node is not xml

**117.14.5.50      public int hashCode()**

- Returns the hash code value for this DmtData instance. The hash code is calculated based on the data (selected by the format) of this object.

*Returns* the hash code value for this object

**117.14.5.51      public String toString()**

- Gets the string representation of the DmtData. This method works for all formats. For string format data - including FORMAT\_RAW\_STRING - the string value itself is returned, while for XML, date, time, integer, float, boolean, long and node formats the string form of the value is returned. Binary - including FORMAT\_RAW\_BINARY - base64 data is represented by two-digit hexadecimal numbers for each byte separated by spaces. The NULL\_VALUE data has the string form of " null". Data of string or XML format containing the Java null value is represented by an empty string. DateTime data is formatted as yyyy-MM-dd'T'HH:mm:ss'Z').

*Returns* the string representation of this DmtData instance

## 117.14.6 public interface DmtEvent

Event class storing the details of a change in the tree. DmtEvent is used by DmtAdmin to notify registered EventListeners services about important changes. Events are generated after every successful DMT change, and also when sessions are opened or closed. If a DmtSession is opened in atomic mode, DMT events are only sent when the session is committed, when the changes are actually performed.

The type of the event describes the change that triggered the event delivery. Each event carries the unique identifier of the session in which the described change happened or -1 when the change originated outside a session. The events describing changes in the DMT carry the list of affected nodes. In case of COPIED or RENAMED events, the event carries the list of new nodes as well.

### 117.14.6.1 public static final int ADDED = 1

Event type indicating nodes that were added.

### 117.14.6.2 public static final int COPIED = 2

Event type indicating nodes that were copied.

### 117.14.6.3 public static final int DELETED = 4

Event type indicating nodes that were deleted.

### 117.14.6.4 public static final int RENAMED = 8

Event type indicating nodes that were renamed.

### 117.14.6.5 public static final int REPLACED = 16

Event type indicating nodes that were replaced.

### 117.14.6.6 public static final int SESSION\_CLOSED = 64

Event type indicating that a session was closed. This type of event is sent when the session is closed by the client or becomes inactive for any other reason (session timeout, fatal errors in business methods, etc.).

### 117.14.6.7 public static final int SESSION\_OPENED = 32

Event type indicating that a new session was opened.

### 117.14.6.8 public String[] getNewNodes()

- This method can be used to query the new nodes, when the type of the event is COPIED or RENAMED. For all other event types this method returns null.

The array returned by this method runs parallel to the array returned by getNodes(), the elements in the two arrays contain the source and destination URIs for the renamed or copied nodes in the same order. All returned URIs are absolute.

This method returns only those nodes where the caller has the GET permission for the source or destination node of the operation. Therefore, it is possible that the method returns an empty array.

*Returns* the array of newly created nodes

### 117.14.6.9 public String[] getNodes()

- This method can be used to query the subject nodes of this event. The method returns null for SESSION\_OPENED and SESSION\_CLOSED.

The method returns only those affected nodes that the caller has the GET permission for (or in case of COPIED or RENAMED events, where the caller has GET permissions for either the source or the

destination nodes). Therefore, it is possible that the method returns an empty array. All returned URIs are absolute.

*Returns* the array of affected nodes

*See Also* `getNewNodes()`

#### 117.14.6.10 **public Object getProperty(String key)**

*key* the name of the requested property

- This method can be used to get the value of a single event property.

*Returns* the requested property value or null, if the key is not contained in the properties

*See Also* `getPropertyNames()`

*Since* 2.0

#### 117.14.6.11 **public String[] getPropertyNames()**

- This method can be used to query the names of all properties of this event.

The returned names can be used as key value in subsequent calls to `getProperty(String)`.

*Returns* the array of property names

*See Also* `getProperty(String)`

*Since* 2.0

#### 117.14.6.12 **public int getSessionId()**

- This method returns the identifier of the session in which this event took place. The ID is guaranteed to be unique on a machine.

For events that do not result from a session, the session id is -1.

The availability of a session.id can also be check by using `getProperty()` with "session.id" as key.

*Returns* the unique identifier of the session that triggered the event or -1 if there is no session associated

#### 117.14.6.13 **public int getType()**

- This method returns the type of this event.

*Returns* the type of this event.

### 117.14.7 **public interface DmtEventListener**

Registered implementations of this class are notified via `DmtEvent` objects about important changes in the tree. Events are generated after every successful DMT change, and also when sessions are opened or closed. If a `DmtSession` is opened in atomic mode, DMT events are only sent when the session is committed, when the changes are actually performed.

Dmt Event Listener services must have permission `DmtPermission.GET` for the nodes in the nodes and `newNodes` property in the Dmt Event.

#### 117.14.7.1 **public static final String FILTER\_EVENT = "osgi.filter.event"**

A number of event types packed in a bitmap. If this service property is provided with a Dmt Event Listener service registration than that listener must only receive events where one of the Dmt Event types occur in the bitmap. The type of this service property must be `Integer`.

#### 117.14.7.2 **public static final String FILTER\_PRINCIPAL = "osgi.filter.principal"**

A number of names of principals. If this service property is provided with a Dmt Event Listener service registration than that listener must only receive events for which at least one of the given principals has Get rights. The type of this service property is `String+`.

**117.14.7.3**      **public static final String FILTER\_SUBTREE = "osgi.filter.subtree"**

A number of sub-tree top nodes that define the scope of the Dmt Event Listener. If this service property is registered then the service must only receive events for nodes that are part of one of the sub-trees. The type of this service property is String+.

**117.14.7.4**      **public void changeOccurred(DmtEvent event)**

*event* the DmtEvent describing the change in detail

- DmtAdmin uses this method to notify the registered listeners about the change. This method is called asynchronously from the actual event occurrence.

**117.14.8**      **public class DmtException  
extends Exception**

Checked exception received when a DMT operation fails. Beside the exception message, a DmtException always contains an error code (one of the constants specified in this class), and may optionally contain the URI of the related node, and information about the cause of the exception.

Some of the error codes defined in this class have a corresponding error code defined in OMA DM, in these cases the name and numerical value from OMA DM is used. Error codes without counterparts in OMA DM were given numbers from a different range, starting from 1.

The cause of the exception (if specified) can either be a single Throwable instance, or a list of such instances if several problems occurred during the execution of a method. An example for the latter is the close method of DmtSession that tries to close multiple plugins, and has to report the exceptions of all failures.

Each constructor has two variants, one accepts a String node URI, the other accepts a String[] node path. The former is used by the DmtAdmin implementation, the latter by the plugins, who receive the node URI as an array of segment names. The constructors are otherwise identical.

Getter methods are provided to retrieve the values of the additional parameters, and the printStackTrace(PrintWriter) method is extended to print the stack trace of all causing throwables as well.

**117.14.8.1**      **public static final int ALERT\_NOT\_ROUTED = 5**

An alert can not be sent from the device to the given principal. This can happen if there is no Remote Alert Sender willing to forward the alert to the given principal, or if no principal was given and the DmtAdmin did not find an appropriate default destination.

This error code does not correspond to any OMA DM response status code. It should be translated to the code 500 "Command Failed" when transferring over OMA DM.

**117.14.8.2**      **public static final int COMMAND\_FAILED = 500**

The recipient encountered an error which prevented it from fulfilling the request.

This error code is only used in situations not covered by any of the other error codes that a method may use. Some methods specify more specific error situations for this code, but it can generally be used for any unexpected condition that causes the command to fail.

This error code corresponds to the OMA DM response status code 500 "Command Failed".

**117.14.8.3**      **public static final int COMMAND\_NOT\_ALLOWED = 405**

The requested command is not allowed on the target node. This includes the following situations:

- an interior node operation is requested for a leaf node, or vice versa (e.g. trying to retrieve the children of a leaf node)
- an attempt is made to create a node where the parent is a leaf node

- an attempt is made to rename or delete the root node of the tree
- an attempt is made to rename or delete the root node of the session
- a write operation (other than setting the ACL) is performed in a non-atomic write session on a node provided by a plugin that is read-only or does not support non-atomic writing
- a node is copied to its descendant
- the ACL of the root node is changed not to include Add rights for all principals

This error code corresponds to the OMA DM response status code 405 "Command not allowed".

#### **117.14.8.4**      **public static final int CONCURRENT\_ACCESS = 4**

An error occurred related to concurrent access of nodes. This can happen for example if a configuration node was deleted directly through the Configuration Admin service, while the node was manipulated via the tree.

This error code does not correspond to any OMA DM response status code. It should be translated to the code 500 "Command Failed" when transferring over OMA DM.

#### **117.14.8.5**      **public static final int DATA\_STORE\_FAILURE = 510**

An error related to the recipient data store occurred while processing the request. This error code may be thrown by any of the methods accessing the tree, but whether it is really used depends on the implementation, and the data store it uses.

This error code corresponds to the OMA DM response status code 510 "Data store failure".

#### **117.14.8.6**      **public static final int FEATURE\_NOT\_SUPPORTED = 406**

The requested command failed because an optional feature required by the command is not supported. For example, opening an atomic session might return this error code if the DmtAdmin implementation does not support transactions. Similarly, accessing the optional node properties (Title, Timestamp, Version, Size) might not succeed if either the DmtAdmin implementation or the underlying plugin does not support the property.

When getting or setting values for interior nodes (an optional optimization feature), a plugin can use this error code to indicate that the given interior node does not support values.

This error code corresponds to the OMA DM response status code 406 "Optional feature not supported".

#### **117.14.8.7**      **public static final int INVALID\_URI = 3**

The requested command failed because the target URI or node name is null or syntactically invalid. This covers the following cases:

- the URI or node name ends with the '\' or '/' character
- the URI is an empty string (only invalid if the method does not accept relative URIs)
- the URI contains the segment "." at a position other than the beginning of the URI
- the node name is ".." or the URI contains such a segment
- the node name contains an unescaped '/' character

See the `Uri.encode(String)` method for support on escaping invalid characters in a URI.

This code is only used if the URI or node name does not match any of the criteria for `URI_TOO_LONG`. This error code does not correspond to any OMA DM response status code. It should be translated to the code 404 "Not Found" when transferring over OMA DM.

#### **117.14.8.8**      **public static final int LIMIT\_EXCEEDED = 413**

The requested operation failed because a specific limit was exceeded, e.g. if a requested resource exceeds a size limit.

This error code corresponds to the OMA DM response status code 413 "Request entity too large".

Since 2.0

**117.14.8.9      public static final int METADATA\_MISMATCH = 2**

Operation failed because of meta data restrictions. This covers any attempted deviation from the parameters defined by the MetaNode objects of the affected nodes, for example in the following situations:

- creating, deleting or renaming a permanent node, or modifying its type
- creating an interior node where the meta-node defines it as a leaf, or vice versa
- any operation on a node which does not have the required access type (e.g. executing a node that lacks the MetaNode.CMD\_EXECUTE access type)
- any node creation or deletion that would violate the cardinality constraints
- any leaf node value setting that would violate the allowed formats, values, mime types, etc.
- any node creation that would violate the allowed node names

This error code can also be used to indicate any other meta data violation, even if it cannot be described by the MetaNode class. For example, detecting a multi-node constraint violation while committing an atomic session should result in this error.

This error code does not correspond to any OMA DM response status code. It should be translated to the code 405 "Command not allowed" when transferring over OMA DM.

**117.14.8.10     public static final int NODE\_ALREADY\_EXISTS = 418**

The requested node creation operation failed because the target already exists. This can occur if the node is created directly (with one of the create... methods), or indirectly (during a copy operation).

This error code corresponds to the OMA DM response status code 418 "Already exists".

**117.14.8.11     public static final int NODE\_NOT\_FOUND = 404**

The requested target node was not found. No indication is given as to whether this is a temporary or permanent condition, unless otherwise noted.

This is only used when the requested node name is valid, otherwise the more specific error codes URI\_TOO\_LONG or INVALID\_URI are used. This error code corresponds to the OMA DM response status code 404 "Not Found".

**117.14.8.12     public static final int PERMISSION\_DENIED = 425**

The requested command failed because the principal associated with the session does not have adequate access control permissions (ACL) on the target. This can only appear in case of remote sessions, i.e. if the session is associated with an authenticated principal.

This error code corresponds to the OMA DM response status code 425 "Permission denied".

**117.14.8.13     public static final int REMOTE\_ERROR = 1**

A device initiated remote operation failed. This is used when the protocol adapter fails to send an alert for any reason.

Alert routing errors (that occur while looking for the proper protocol adapter to use) are indicated by ALERT\_NOT\_ROUTED, this code is only for errors encountered while sending the routed alert. This error code does not correspond to any OMA DM response status code. It should be translated to the code 500 "Command Failed" when transferring over OMA DM.

**117.14.8.14     public static final int ROLLBACK\_FAILED = 516**

The rollback command was not completed successfully. The tree might be in an inconsistent state after this error.



This error code corresponds to the OMA DM response status code 516 "Atomic roll back failed".

**117.14.8.15**      **public static final int SESSION\_CREATION\_TIMEOUT = 7**

Creation of a session timed out because of another ongoing session. The length of time while the DmtAdmin waits for the blocking session(s) to finish is implementation dependent.

This error code does not correspond to any OMA DM response status code. OMA has several status codes related to timeout, but these are meant to be used when a request times out, not if a session can not be established. This error code should be translated to the code 500 "Command Failed" when transferring over OMA DM.

**117.14.8.16**      **public static final int TRANSACTION\_ERROR = 6**

A transaction-related error occurred in an atomic session. This error is caused by one of the following situations:

- an updating method within an atomic session can not be executed because the underlying plugin is read-only or does not support atomic writing
- a commit operation at the end of an atomic session failed because one of the underlying plugins failed to close

The latter case may leave the tree in an inconsistent state due to the lack of a two-phase commit system, see `DmtSession.commit()` for details.

This error code does not correspond to any OMA DM response status code. It should be translated to the code 500 "Command Failed" when transferring over OMA DM.

**117.14.8.17**      **public static final int UNAUTHORIZED = 401**

The originator's authentication credentials specify a principal with insufficient rights to complete the command.

This status code is used as response to device originated sessions if the remote management server cannot authorize the device to perform the requested operation.

This error code corresponds to the OMA DM response status code 401 "Unauthorized".

**117.14.8.18**      **public static final int URI\_TOO\_LONG = 414**

The requested command failed because the target URI is too long for what the recipient is able or willing to process.

This error code corresponds to the OMA DM response status code 414 "URI too long".

*See Also* OSGi Service Platform, Mobile Specification Release 4

**117.14.8.19**      **public DmtException(String uri,int code,String message)**

*uri* the node on which the failed DMT operation was issued, or null if the operation is not associated with a node

*code* the error code of the failure

*message* the message associated with the exception, or null if there is no error message

- Create an instance of the exception. The *uri* and *message* parameters are optional. No originating exception is specified.

**117.14.8.20**      **public DmtException(String uri,int code,String message,Throwable cause)**

*uri* the node on which the failed DMT operation was issued, or null if the operation is not associated with a node

*code* the error code of the failure

*message* the message associated with the exception, or null if there is no error message

*cause* the originating exception, or null if there is no originating exception

- Create an instance of the exception, specifying the cause exception. The *uri*, *message* and *cause* parameters are optional.

**117.14.8.21      `public DmtException(String uri,int code,String message,Vector causes,boolean fatal)`**

*uri* the node on which the failed DMT operation was issued, or null if the operation is not associated with a node

*code* the error code of the failure

*message* the message associated with the exception, or null if there is no error message

*causes* the list of originating exceptions, or empty list or null if there are no originating exceptions

*fatal* whether the exception is fatal

- Create an instance of the exception, specifying the list of cause exceptions and whether the exception is a fatal one. This constructor is meant to be used by plugins wishing to indicate that a serious error occurred which should invalidate the ongoing atomic session. The *uri*, *message* and *causes* parameters are optional.

If a fatal exception is thrown, no further business methods will be called on the originator plugin. In case of atomic sessions, all other open plugins will be rolled back automatically, except if the fatal exception was thrown during commit.

**117.14.8.22      `public DmtException(String[] path,int code,String message)`**

*path* the path of the node on which the failed DMT operation was issued, or null if the operation is not associated with a node

*code* the error code of the failure

*message* the message associated with the exception, or null if there is no error message

- Create an instance of the exception, specifying the target node as an array of path segments. This method behaves in exactly the same way as if the path was given as a URI string.

*See Also* `DmtException(String, int, String)`

**117.14.8.23      `public DmtException(String[] path,int code,String message,Throwable cause)`**

*path* the path of the node on which the failed DMT operation was issued, or null if the operation is not associated with a node

*code* the error code of the failure

*message* the message associated with the exception, or null if there is no error message

*cause* the originating exception, or null if there is no originating exception

- Create an instance of the exception, specifying the target node as an array of path segments, and specifying the cause exception. This method behaves in exactly the same way as if the path was given as a URI string.

*See Also* `DmtException(String, int, String, Throwable)`

**117.14.8.24      `public DmtException(String[] path,int code,String message,Vector causes,boolean fatal)`**

*path* the path of the node on which the failed DMT operation was issued, or null if the operation is not associated with a node

*code* the error code of the failure

*message* the message associated with the exception, or null if there is no error message

*causes* the list of originating exceptions, or empty list or null if there are no originating exceptions

*fatal* whether the exception is fatal

- Create an instance of the exception, specifying the target node as an array of path segments, the list of cause exceptions, and whether the exception is a fatal one. This method behaves in exactly the same way as if the path was given as a URI string.

*See Also* `DmtException(String, int, String, Vector, boolean)`

#### 117.14.8.25 **public Throwable getCause()**

- Get the cause of this exception. Returns non-null, if this exception is caused by one or more other exceptions (like a `NullPointerException` in a `DmtPlugin`). If there are more than one cause exceptions, the first one is returned.

*Returns* the cause of this exception, or null if no cause was given

#### 117.14.8.26 **public Throwable[] getCauses()**

- Get all causes of this exception. Returns the causing exceptions in an array. If no cause was specified, an empty array is returned.

*Returns* the list of causes of this exception

#### 117.14.8.27 **public int getCode()**

- Get the error code associated with this exception. Most of the error codes within this exception correspond to OMA DM error codes.

*Returns* the error code

#### 117.14.8.28 **public String getMessage()**

- Get the message associated with this exception. The returned string also contains the associated URI (if any) and the exception code. The resulting message has the following format (parts in square brackets are only included if the field inside them is not null):

```
<exception_code>[: '<uri>'][: <error_message>]
```

*Returns* the error message in the format described above

#### 117.14.8.29 **public String getURI()**

- Get the node on which the failed DMT operation was issued. Some operations like `DmtSession.close()` don't require an URI, in this case this method returns null.

*Returns* the URI of the node, or null

#### 117.14.8.30 **public boolean isFatal()**

- Check whether this exception is marked as fatal in the session. Fatal exceptions trigger an automatic rollback of atomic sessions.

*Returns* whether the exception is marked as fatal

#### 117.14.8.31 **public void printStackTrace(PrintStream s)**

- s `PrintStream` to use for output
- Prints the exception and its stacktrace to the specified print stream. Any causes that were specified for this exception are also printed, together with their stacktraces.

### 117.14.9 **public class DmtIllegalStateException extends RuntimeException**

Unchecked illegal state exception. This class is used in DMT because `java.lang.IllegalStateException` does not exist in CLDC.

**117.14.9.1 public DmtIllegalStateException()**

- Create an instance of the exception with no message.

**117.14.9.2 public DmtIllegalStateException(String message)**

*message* the reason for the exception

- Create an instance of the exception with the specified message.

**117.14.9.3 public DmtIllegalStateException(Throwable cause)**

*cause* the cause of the exception

- Create an instance of the exception with the specified cause exception and no message.

**117.14.9.4 public DmtIllegalStateException(String message,Throwable cause)**

*message* the reason for the exception

*cause* the cause of the exception

- Create an instance of the exception with the specified message and cause exception.

**117.14.10 public interface DmtSession**

DmtSession provides concurrent access to the DMT. All DMT manipulation commands for management applications are available on the DmtSession interface. The session is associated with a root node which limits the subtree in which the operations can be executed within this session.

Most of the operations take a node URI as parameter, which can be either an absolute URI (starting with ".") or a URI relative to the root node of the session. The empty string as relative URI means the root URI the session was opened with. All segments of a URI must be within the segment length limit of the implementation, and the special characters '/' and '\' must be escaped (preceded by a '\').

See the Uri.encode(String) method for support on escaping invalid characters in a URI.

If the URI specified does not correspond to a legitimate node in the tree an exception is thrown. The only exception is the isNodeUri(String) method which returns false in case of an invalid URI.

Each method of DmtSession that accesses the tree in any way can throw DmtIllegalStateException if the session has been closed or invalidated (due to timeout, fatal exceptions, or unexpectedly unregistered plugins).

**117.14.10.1 public static final int LOCK\_TYPE\_ATOMIC = 2**

LOCK\_TYPE\_ATOMIC is an exclusive lock with transactional functionality. Commands of an atomic session will either fail or succeed together, if a single command fails then the whole session will be rolled back.

**117.14.10.2 public static final int LOCK\_TYPE\_EXCLUSIVE = 1**

LOCK\_TYPE\_EXCLUSIVE lock guarantees full access to the tree, but can not be shared with any other locks.

**117.14.10.3 public static final int LOCK\_TYPE\_SHARED = 0**

Sessions created with LOCK\_TYPE\_SHARED lock allows read-only access to the tree, but can be shared between multiple readers.

**117.14.10.4 public static final int STATE\_CLOSED = 1**

The session is closed, DMT manipulation operations are not available, they throw DmtIllegalStateException if tried.

**117.14.10.5 public static final int STATE\_INVALID = 2**

The session is invalid because a fatal error happened. Fatal errors include the timeout of the session, any `DmtException` with the 'fatal' flag set, or the case when a plugin service is unregistered while in use by the session. DMT manipulation operations are not available, they throw `DmtIllegalStateException` if tried.

**117.14.10.6 public static final int STATE\_OPEN = 0**

The session is open, all session operations are available.

**117.14.10.7 public void close() throws DmtException**

- Closes a session. If the session was opened with atomic lock mode, the `DmtSession` must first persist the changes made to the DMT by calling `commit()` on all (transactional) plugins participating in the session. See the documentation of the `commit()` method for details and possible errors during this operation.

The state of the session changes to `DmtSession.STATE_CLOSED` if the close operation completed successfully, otherwise it becomes `DmtSession.STATE_INVALID`.

*Throws* `DmtException`– with the following possible error codes:

- `METADATA_MISMATCH` in case of atomic sessions, if the commit operation failed because of meta-data restrictions
- `CONCURRENT_ACCESS` in case of atomic sessions, if the commit operation failed because of some modification outside the scope of the DMT to the nodes affected in the session
- `TRANSACTION_ERROR` in case of atomic sessions, if an underlying plugin failed to commit
- `DATA_STORE_FAILURE` if an error occurred while accessing the data store
- `COMMAND_FAILED` if an underlying plugin failed to close, or if some unspecified error is encountered while attempting to complete the command

`DmtIllegalStateException`– if the session is already closed or invalidated

`SecurityException`– if the caller does not have the necessary permissions to execute the underlying management operation

**117.14.10.8 public void commit() throws DmtException**

- Commits a series of DMT operations issued in the current atomic session since the last transaction boundary. Transaction boundaries are the creation of this object that starts the session, and all subsequent `commit()` and `rollback()` calls.

This method can fail even if all operations were successful. This can happen due to some multi-node semantic constraints defined by a specific implementation. For example, node A can be required to always have children A/B, A/C and A/D. If this condition is broken when `commit()` is executed, the method will fail, and throw a `METADATA_MISMATCH` exception.

An error situation can arise due to the lack of a two phase commit mechanism in the underlying plugins. As an example, if plugin A has committed successfully but plugin B failed, the whole session must fail, but there is no way to undo the commit performed by A. To provide predictable behavior, the commit operation should continue with the remaining plugins even after detecting a failure. All exceptions received from failed commits are aggregated into one `TRANSACTION_ERROR` exception thrown by this method.

In many cases the tree is not the only way to manage a given part of the system. It may happen that while modifying some nodes in an atomic session, the underlying settings are modified in parallel outside the scope of the DMT. If this is detected during commit, an exception with the code `CONCURRENT_ACCESS` is thrown.

*Throws* `DmtException`– with the following possible error codes:

- METADATA\_MISMATCH if the operation failed because of meta-data restrictions
- CONCURRENT\_ACCESS if it is detected that some modification has been made outside the scope of the DMT to the nodes affected in the session's operations
- TRANSACTION\_ERROR if an error occurred during the commit of any of the underlying plugins
- DATA\_STORE\_FAILURE if an error occurred while accessing the data store
- COMMAND\_FAILED if some unspecified error is encountered while attempting to complete the command

`DmtIllegalStateException`— if the session was not opened using the `LOCK_TYPE_ATOMIC` lock type, or if the session is already closed or invalidated

`SecurityException`— if the caller does not have the necessary permissions to execute the underlying management operation

#### 117.14.10.9 **public void copy(String nodeUri, String newNodeUri, boolean recursive) throws DmtException**

*nodeUri* the node or root of a subtree to be copied

*newNodeUri* the URI of the new node or root of a subtree

*recursive* false if only a single node is copied, true if the whole subtree is copied

- Create a copy of a node or a whole subtree. Beside the structure and values of the nodes, most properties are also copied, with the exception of the ACL (Access Control List), Timestamp and Version properties.

The copy method is essentially a convenience method that could be substituted with a sequence of retrieval and update operations. This determines the permissions required for copying. However, some optimization can be possible if the source and target nodes are all handled by `DmtAdmin` or by the same plugin. In this case, the handler might be able to perform the underlying management operation more efficiently: for example, a configuration table can be copied at once instead of reading each node for each entry and creating it in the new tree.

This method may result in any of the errors possible for the contributing operations. Most of these are collected in the exception descriptions below, but for the full list also consult the documentation of `getChildNodeNames(String)`, `isLeafNode(String)`, `getNodeValue(String)`, `getNodeTitle(String)`, `setNodeTitle(String, String)`, `createLeafNode(String, DmtData, String)` and `createInteriorNode(String, String)`.

*Throws* `DmtException`— with the following possible error codes:

- `INVALID_URI` if `nodeUri` or `newNodeUri` is null or syntactically invalid
- `URI_TOO_LONG` if `nodeUri` is longer than accepted by the `DmtAdmin` implementation (especially on systems with limited resources)
- `NODE_NOT_FOUND` if `nodeUri` points to a non-existing node, or if `newNodeUri` points to a node that cannot exist in the tree according to the meta-data (see `getMetaNode(String)`)
- `NODE_ALREADY_EXISTS` if `newNodeUri` points to a node that already exists
- `PERMISSION_DENIED` if the session is associated with a principal and the ACL of the copied node(s) does not allow the Get operation, or the ACL of the parent of the target node does not allow the Add operation for the associated principal
- `COMMAND_NOT_ALLOWED` if `nodeUri` is an ancestor of `newNodeUri`, or if any of the implied retrieval or update operations are not allowed
- `METADATA_MISMATCH` if any of the meta-data constraints of the implied retrieval or update operations are violated
- `TRANSACTION_ERROR` in an atomic session if the underlying plugin is read-only or does not support atomic writing
- `DATA_STORE_FAILURE` if an error occurred while accessing the data store

- `COMMAND_FAILED` if either URI is not within the current session's subtree, or if some unspecified error is encountered while attempting to complete the command

`DmtIllegalStateException`– if the session was opened using the `LOCK_TYPE_SHARED` lock type, or if the session is already closed or invalidated

`SecurityException`– if the caller does not have the necessary permissions to execute the underlying management operation, or, in case of local sessions, if the caller does not have `DmtPermission` for the copied node(s) with the `Get` action present, or for the parent of the target node with the `Add` action

#### 117.14.10.10 **public void createInteriorNode(String nodeUri) throws DmtException**

*nodeUri* the URI of the node to create

- Create an interior node. If the parent node does not exist, it is created automatically, as if this method were called for the parent URI. This way all missing ancestor nodes leading to the specified node are created. Any exceptions encountered while creating the ancestors are propagated to the caller of this method, these are not explicitly listed in the error descriptions below.

If meta-data is available for the node, several checks are made before creating it. The node must have `MetaNode.CMD_ADD` access type, it must be defined as a non-permanent interior node, the node name must conform to the valid names, and the creation of the new node must not cause the maximum occurrence number to be exceeded.

If the meta-data cannot be retrieved because the given node cannot possibly exist in the tree (it is not defined in the specification), the `NODE_NOT_FOUND` error code is returned (see `getMetaNode(String)`).

*Throws* `DmtException`– with the following possible error codes:

- `INVALID_URI` if *nodeUri* is null or syntactically invalid
- `URI_TOO_LONG` if *nodeUri* is longer than accepted by the `DmtAdmin` implementation (especially on systems with limited resources)
- `NODE_NOT_FOUND` if *nodeUri* points to a node that cannot exist in the tree (see above)
- `NODE_ALREADY_EXISTS` if *nodeUri* points to a node that already exists
- `PERMISSION_DENIED` if the session is associated with a principal and the ACL of the parent node does not allow the `Add` operation for the associated principal
- `COMMAND_NOT_ALLOWED` if the parent node is not an interior node, or in non-atomic sessions if the underlying plugin is read-only or does not support non-atomic writing
- `METADATA_MISMATCH` if the node could not be created because of meta-data restrictions (see above)
- `TRANSACTION_ERROR` in an atomic session if the underlying plugin is read-only or does not support atomic writing
- `DATA_STORE_FAILURE` if an error occurred while accessing the data store
- `COMMAND_FAILED` if the URI is not within the current session's subtree, or if some unspecified error is encountered while attempting to complete the command

`DmtIllegalStateException`– if the session was opened using the `LOCK_TYPE_SHARED` lock type, or if the session is already closed or invalidated

`SecurityException`– if the caller does not have the necessary permissions to execute the underlying management operation, or, in case of local sessions, if the caller does not have `DmtPermission` for the parent node with the `Add` action present

#### 117.14.10.11 **public void createInteriorNode(String nodeUri,String type) throws DmtException**

*nodeUri* the URI of the node to create

*type* the type URI of the interior node, can be null if no node type is defined

- Create an interior node with a given type. The type of interior node, if specified, is a URI identifying a DDF document. If the parent node does not exist, it is created automatically, as if `createInteriorNode(String)` were called for the parent URI. This way all missing ancestor nodes leading to the specified node are created. Any exceptions encountered while creating the ancestors are propagated to the caller of this method, these are not explicitly listed in the error descriptions below.

If meta-data is available for the node, several checks are made before creating it. The node must have `MetaNode.CMD_ADD` access type, it must be defined as a non-permanent interior node, the node name must conform to the valid names, and the creation of the new node must not cause the maximum occurrence number to be exceeded.

If the meta-data cannot be retrieved because the given node cannot possibly exist in the tree (it is not defined in the specification), the `NODE_NOT_FOUND` error code is returned (see `getMetaNode(String)`).

Interior node type identifiers must follow the format defined in section 7.7.7.2 of the OMA Device Management Tree and Description document. Checking the validity of the type string does not have to be done by the `DmtAdmin`, this can be left to the plugin handling the node (if any), to avoid unnecessary double-checks.

*Throws* `DmtException`– with the following possible error codes:

- `INVALID_URI` if `nodeUri` is null or syntactically invalid
- `URI_TOO_LONG` if `nodeUri` is longer than accepted by the `DmtAdmin` implementation (especially on systems with limited resources)
- `NODE_NOT_FOUND` if `nodeUri` points to a node that cannot exist in the tree (see above)
- `NODE_ALREADY_EXISTS` if `nodeUri` points to a node that already exists
- `PERMISSION_DENIED` if the session is associated with a principal and the ACL of the parent node does not allow the Add operation for the associated principal
- `COMMAND_NOT_ALLOWED` if the parent node is not an interior node, or in non-atomic sessions if the underlying plugin is read-only or does not support non-atomic writing
- `METADATA_MISMATCH` if the node could not be created because of meta-data restrictions (see above)
- `TRANSACTION_ERROR` in an atomic session if the underlying plugin is read-only or does not support atomic writing
- `DATA_STORE_FAILURE` if an error occurred while accessing the data store
- `COMMAND_FAILED` if the URI is not within the current session's subtree, if the type string is invalid (see above), or if some unspecified error is encountered while attempting to complete the command

`DmtIllegalStateException`– if the session was opened using the `LOCK_TYPE_SHARED` lock type, or if the session is already closed or invalidated

`SecurityException`– if the caller does not have the necessary permissions to execute the underlying management operation, or, in case of local sessions, if the caller does not have `DmtPermission` for the parent node with the Add action present

*See Also* `createInteriorNode(String)`, OMA Device Management Tree and Description v1.2 draft [[http://member.openmobilealliance.org/ftp/public\\_documents/dm/Permanent\\_documents/OMA-TS-DM-TND-V1\\_2-20050615-C.zip](http://member.openmobilealliance.org/ftp/public_documents/dm/Permanent_documents/OMA-TS-DM-TND-V1_2-20050615-C.zip)]

#### **117.14.10.12 public void createLeafNode(String nodeUri) throws DmtException**

*nodeUri* the URI of the node to create

- Create a leaf node with default value and MIME type. If a node does not have a default value or MIME type, this method will throw a `DmtException` with error code `METADATA_MISMATCH`. Note



that a node might have a default value or MIME type even if there is no meta-data for the node or its meta-data does not specify the default.

If the parent node does not exist, it is created automatically, as if `createInteriorNode(String)` were called for the parent URI. This way all missing ancestor nodes leading to the specified node are created. Any exceptions encountered while creating the ancestors are propagated to the caller of this method, these are not explicitly listed in the error descriptions below.

If meta-data is available for a node, several checks are made before creating it. The node must have `MetaNode.CMD_ADD` access type, it must be defined as a non-permanent leaf node, the node name must conform to the valid names, and the creation of the new node must not cause the maximum occurrence number to be exceeded.

If the meta-data cannot be retrieved because the given node cannot possibly exist in the tree (it is not defined in the specification), the `NODE_NOT_FOUND` error code is returned (see `getMetaNode(String)`).

*Throws* `DmtException`– with the following possible error codes:

- `INVALID_URI` if `nodeUri` is null or syntactically invalid
- `URI_TOO_LONG` if `nodeUri` is longer than accepted by the `DmtAdmin` implementation (especially on systems with limited resources)
- `NODE_NOT_FOUND` if `nodeUri` points to a node that cannot exist in the tree (see above)
- `NODE_ALREADY_EXISTS` if `nodeUri` points to a node that already exists
- `PERMISSION_DENIED` if the session is associated with a principal and the ACL of the parent node does not allow the Add operation for the associated principal
- `COMMAND_NOT_ALLOWED` if the parent node is not an interior node, or in non-atomic sessions if the underlying plugin is read-only or does not support non-atomic writing
- `METADATA_MISMATCH` if the node could not be created because of meta-data restrictions (see above)
- `TRANSACTION_ERROR` in an atomic session if the underlying plugin is read-only or does not support atomic writing
- `DATA_STORE_FAILURE` if an error occurred while accessing the data store
- `COMMAND_FAILED` if the URI is not within the current session's subtree, or if some unspecified error is encountered while attempting to complete the command

`DmtIllegalStateException`– if the session was opened using the `LOCK_TYPE_SHARED` lock type, or if the session is already closed or invalidated

`SecurityException`– if the caller does not have the necessary permissions to execute the underlying management operation, or, in case of local sessions, if the caller does not have `DmtPermission` for the parent node with the Add action present

*See Also* `createLeafNode(String, DmtData)`

#### **117.14.10.13      public void createLeafNode(String nodeUri, DmtData value) throws DmtException**

*nodeUri* the URI of the node to create

*value* the value to be given to the new node, can be null

- Create a leaf node with a given value and the default MIME type. If the specified value is null, the default value is taken. If the node does not have a default MIME type or value (if needed), this method will throw a `DmtException` with error code `METADATA_MISMATCH`. Note that a node might have a default value or MIME type even if there is no meta-data for the node or its meta-data does not specify the default.

If the parent node does not exist, it is created automatically, as if `createInteriorNode(String)` were called for the parent URI. This way all missing ancestor nodes leading to the specified node are cre-

ated. Any exceptions encountered while creating the ancestors are propagated to the caller of this method, these are not explicitly listed in the error descriptions below.

If meta-data is available for a node, several checks are made before creating it. The node must have `MetaNode.CMD_ADD` access type, it must be defined as a non-permanent leaf node, the node name must conform to the valid names, the node value must conform to the value constraints, and the creation of the new node must not cause the maximum occurrence number to be exceeded.

If the meta-data cannot be retrieved because the given node cannot possibly exist in the tree (it is not defined in the specification), the `NODE_NOT_FOUND` error code is returned (see `getMetaNode(String)`).

Nodes of null format can be created by using `DmtData.NULL_VALUE` as second argument.

*Throws* `DmtException`– with the following possible error codes:

- `INVALID_URI` if `nodeUri` is null or syntactically invalid
- `URI_TOO_LONG` if `nodeUri` is longer than accepted by the `DmtAdmin` implementation (especially on systems with limited resources)
- `NODE_NOT_FOUND` if `nodeUri` points to a node that cannot exist in the tree (see above)
- `NODE_ALREADY_EXISTS` if `nodeUri` points to a node that already exists
- `PERMISSION_DENIED` if the session is associated with a principal and the ACL of the parent node does not allow the Add operation for the associated principal
- `COMMAND_NOT_ALLOWED` if the parent node is not an interior node, or in non-atomic sessions if the underlying plugin is read-only or does not support non-atomic writing
- `METADATA_MISMATCH` if the node could not be created because of meta-data restrictions (see above)
- `TRANSACTION_ERROR` in an atomic session if the underlying plugin is read-only or does not support atomic writing
- `DATA_STORE_FAILURE` if an error occurred while accessing the data store
- `COMMAND_FAILED` if the URI is not within the current session's subtree, or if some unspecified error is encountered while attempting to complete the command

`DmtIllegalStateException`– if the session was opened using the `LOCK_TYPE_SHARED` lock type, or if the session is already closed or invalidated

`SecurityException`– if the caller does not have the necessary permissions to execute the underlying management operation, or, in case of local sessions, if the caller does not have `DmtPermission` for the parent node with the Add action present

#### **117.14.10.14      `public void createLeafNode(String nodeUri, DmtData value, String mimeType) throws DmtException`**

*nodeUri* the URI of the node to create

*value* the value to be given to the new node, can be null

*mimeType* the MIME type to be given to the new node, can be null

- Create a leaf node with a given value and MIME type. If the specified value or MIME type is null, their default values are taken. If the node does not have the necessary defaults, this method will throw a `DmtException` with error code `METADATA_MISMATCH`. Note that a node might have a default value or MIME type even if there is no meta-data for the node or its meta-data does not specify the default.

If the parent node does not exist, it is created automatically, as if `createInteriorNode(String)` were called for the parent URI. This way all missing ancestor nodes leading to the specified node are created. Any exceptions encountered while creating the ancestors are propagated to the caller of this method, these are not explicitly listed in the error descriptions below.

If meta-data is available for a node, several checks are made before creating it. The node must have `MetaNode.CMD_ADD` access type, it must be defined as a non-permanent leaf node, the node name must conform to the valid names, the node value must conform to the value constraints, the MIME type must be among the listed types, and the creation of the new node must not cause the maximum occurrence number to be exceeded.

If the meta-data cannot be retrieved because the given node cannot possibly exist in the tree (it is not defined in the specification), the `NODE_NOT_FOUND` error code is returned (see `getMetaNode(String)`).

Nodes of null format can be created by using `DmtData.NULL_VALUE` as second argument.

The MIME type string must conform to the definition in RFC 2045. Checking its validity does not have to be done by the `DmtAdmin`, this can be left to the plugin handling the node (if any), to avoid unnecessary double-checks.

*Throws* `DmtException`– with the following possible error codes:

- `INVALID_URI` if `nodeUri` is null or syntactically invalid
- `URI_TOO_LONG` if `nodeUri` is longer than accepted by the `DmtAdmin` implementation (especially on systems with limited resources)
- `NODE_NOT_FOUND` if `nodeUri` points to a node that cannot exist in the tree (see above)
- `NODE_ALREADY_EXISTS` if `nodeUri` points to a node that already exists
- `PERMISSION_DENIED` if the session is associated with a principal and the ACL of the parent node does not allow the Add operation for the associated principal
- `COMMAND_NOT_ALLOWED` if the parent node is not an interior node, or in non-atomic sessions if the underlying plugin is read-only or does not support non-atomic writing
- `METADATA_MISMATCH` if the node could not be created because of meta-data restrictions (see above)
- `TRANSACTION_ERROR` in an atomic session if the underlying plugin is read-only or does not support atomic writing
- `DATA_STORE_FAILURE` if an error occurred while accessing the data store
- `COMMAND_FAILED` if the URI is not within the current session's subtree, if `mimeType` is not a proper MIME type string (see above), or if some unspecified error is encountered while attempting to complete the command

`DmtIllegalStateException`– if the session was opened using the `LOCK_TYPE_SHARED` lock type, or if the session is already closed or invalidated

`SecurityException`– if the caller does not have the necessary permissions to execute the underlying management operation, or, in case of local sessions, if the caller does not have `DmtPermission` for the parent node with the Add action present

*See Also* `createLeafNode(String, DmtData)`, RFC 2045 [<http://www.ietf.org/rfc/rfc2045.txt>]

#### **117.14.10.15 public void deleteNode(String nodeUri) throws DmtException**

*nodeUri* the URI of the node

- Delete the given node. Deleting interior nodes is recursive, the whole subtree under the given node is deleted. It is not allowed to delete the root node of the session.

If meta-data is available for a node, several checks are made before deleting it. The node must be non-permanent, it must have the `MetaNode.CMD_DELETE` access type, and if zero occurrences of the node are not allowed, it must not be the last one.

*Throws* `DmtException`– with the following possible error codes:

- `INVALID_URI` if `nodeUri` is null or syntactically invalid

- `URI_TOO_LONG` if `nodeUri` is longer than accepted by the `DmtAdmin` implementation (especially on systems with limited resources)
- `NODE_NOT_FOUND` if `nodeUri` points to a non-existing node
- `PERMISSION_DENIED` if the session is associated with a principal and the ACL of the node does not allow the Delete operation for the associated principal
- `COMMAND_NOT_ALLOWED` if the target node is the root of the session, or in non-atomic sessions if the underlying plugin is read-only or does not support non-atomic writing
- `METADATA_MISMATCH` if the node could not be deleted because of meta-data restrictions (see above)
- `TRANSACTION_ERROR` in an atomic session if the underlying plugin is read-only or does not support atomic writing
- `DATA_STORE_FAILURE` if an error occurred while accessing the data store
- `COMMAND_FAILED` if the URI is not within the current session's subtree, or if some unspecified error is encountered while attempting to complete the command

`DmtIllegalStateException`– if the session was opened using the `LOCK_TYPE_SHARED` lock type, or if the session is already closed or invalidated

`SecurityException`– if the caller does not have the necessary permissions to execute the underlying management operation, or, in case of local sessions, if the caller does not have `DmtPermission` for the node with the Delete action present

#### 117.14.10.16 **public void execute(String nodeUri,String data) throws DmtException**

*nodeUri* the node on which the execute operation is issued

*data* the parameter of the execute operation, can be null

- Executes a node. This corresponds to the EXEC operation in OMA DM. This method cannot be called in a read-only session.

The semantics of an execute operation and the data parameter it takes depends on the definition of the managed object on which the command is issued.

*Throws* `DmtException`– with the following possible error codes:

- `INVALID_URI` if `nodeUri` is null or syntactically invalid
- `URI_TOO_LONG` if `nodeUri` is longer than accepted by the `DmtAdmin` implementation (especially on systems with limited resources)
- `NODE_NOT_FOUND` if the node does not exist
- `PERMISSION_DENIED` if the session is associated with a principal and the ACL of the node does not allow the Execute operation for the associated principal
- `COMMAND_NOT_ALLOWED` if the specified node is a scaffold node
- `METADATA_MISMATCH` if the node cannot be executed according to the meta-data (does not have `MetaNode.CMD_EXECUTE` access type)
- `DATA_STORE_FAILURE` if an error occurred while accessing the data store
- `COMMAND_FAILED` if the URI is not within the current session's subtree, if no `DmtExecPlugin` is associated with the node and the `DmtAdmin` can not execute the node, or if some unspecified error is encountered while attempting to complete the command

`DmtIllegalStateException`– if the session was opened using the `LOCK_TYPE_SHARED` lock type, or if the session is already closed or invalidated

`SecurityException`– if the caller does not have the necessary permissions to execute the underlying management operation, or, in case of local sessions, if the caller does not have `DmtPermission` for the node with the Exec action present

*See Also* `execute(String, String, String)`

**117.14.10.17 public void execute(String nodeUri,String correlator,String data) throws DmtException**

*nodeUri* the node on which the execute operation is issued

*correlator* an identifier to associate this operation with any notifications sent in response to it, can be null if not needed

*data* the parameter of the execute operation, can be null

- Executes a node, also specifying a correlation ID for use in response notifications. This operation corresponds to the EXEC command in OMA DM. This method cannot be called in a read-only session.

The semantics of an execute operation and the data parameter it takes depends on the definition of the managed object on which the command is issued. If a correlation ID is specified, it should be used as the correlator parameter for notifications sent in response to this execute operation.

*Throws* DmtException– with the following possible error codes:

- INVALID\_URI if nodeUri is null or syntactically invalid
- URI\_TOO\_LONG if nodeUri is longer than accepted by the DmtAdmin implementation (especially on systems with limited resources)
- NODE\_NOT\_FOUND if the node does not exist
- PERMISSION\_DENIED if the session is associated with a principal and the ACL of the node does not allow the Execute operation for the associated principal
- COMMAND\_NOT\_ALLOWED if the specified node is a scaffold node
- METADATA\_MISMATCH if the node cannot be executed according to the meta-data (does not have MetaNode.CMD\_EXECUTE access type)
- DATA\_STORE\_FAILURE if an error occurred while accessing the data store
- COMMAND\_FAILED if the URI is not within the current session's subtree, if no DmtExecPlugin is associated with the node, or if some unspecified error is encountered while attempting to complete the command

DmtIllegalStateException– if the session was opened using the LOCK\_TYPE\_SHARED lock type, or if the session is already closed or invalidated

SecurityException– if the caller does not have the necessary permissions to execute the underlying management operation, or, in case of local sessions, if the caller does not have DmtPermission for the node with the Exec action present

*See Also* execute(String, String)

**117.14.10.18 public String[] getChildNodeNames(String nodeUri) throws DmtException**

*nodeUri* the URI of the node

- Get the list of children names of a node. The returned array contains the names - not the URIs - of the immediate children nodes of the given node. The elements are in no particular order. The returned array must not contain null entries.

*Returns* the list of child node names as a string array or an empty string array if the node has no children

*Throws* DmtException– with the following possible error codes:

- INVALID\_URI if nodeUri is null or syntactically invalid
- URI\_TOO\_LONG if nodeUri is longer than accepted by the DmtAdmin implementation (especially on systems with limited resources)
- NODE\_NOT\_FOUND if nodeUri points to a non-existing node
- PERMISSION\_DENIED if the session is associated with a principal and the ACL of the node does not allow the Get operation for the associated principal

- `COMMAND_NOT_ALLOWED` if the specified node is not an interior node
- `METADATA_MISMATCH` if node information cannot be retrieved according to the meta-data (it does not have `MetaNode.CMD_GET` access type)
- `DATA_STORE_FAILURE` if an error occurred while accessing the data store
- `COMMAND_FAILED` if the URI is not within the current session's subtree, or if some unspecified error is encountered while attempting to complete the command

`DmtIllegalStateException`– if the session is already closed or invalidated

`SecurityException`– if the caller does not have the necessary permissions to execute the underlying management operation, or, in case of local sessions, if the caller does not have `DmtPermission` for the node with the Get action present

#### 117.14.10.19 **public Acl getEffectiveNodeAcl(String nodeUri) throws DmtException**

*nodeUri* the URI of the node

- Gives the Access Control List in effect for a given node. The returned `Acl` takes inheritance into account, that is if there is no ACL defined for the node, it will be derived from the closest ancestor having an ACL defined.

*Returns* the Access Control List belonging to the node

*Throws* `DmtException`– with the following possible error codes:

- `INVALID_URI` if `nodeUri` is null or syntactically invalid
- `URI_TOO_LONG` if `nodeUri` is longer than accepted by the `DmtAdmin` implementation (especially on systems with limited resources)
- `NODE_NOT_FOUND` if `nodeUri` points to a non-existing node
- `PERMISSION_DENIED` if the session is associated with a principal and the ACL of the node does not allow the Get operation for the associated principal
- `METADATA_MISMATCH` if node information cannot be retrieved according to the meta-data (the node does not have `MetaNode.CMD_GET` access type)
- `DATA_STORE_FAILURE` if an error occurred while accessing the data store
- `COMMAND_FAILED` if the URI is not within the current session's subtree, or if some unspecified error is encountered while attempting to complete the command

`DmtIllegalStateException`– if the session is already closed or invalidated

`SecurityException`– in case of local sessions, if the caller does not have `DmtPermission` for the node with the Get action present

*See Also* `getNodeAcl(String)`

#### 117.14.10.20 **public int getLockType()**

- Gives the type of lock the session has.

*Returns* the lock type of the session, one of `LOCK_TYPE_SHARED`, `LOCK_TYPE_EXCLUSIVE` and `LOCK_TYPE_ATOMIC`

#### 117.14.10.21 **public MetaNode getMetaNode(String nodeUri) throws DmtException**

*nodeUri* the URI of the node

- Get the meta data which describes a given node. Meta data can only be inspected, it can not be changed.

The `MetaNode` object returned to the client is the combination of the meta data returned by the data plugin (if any) plus the meta data returned by the `DmtAdmin`. If there are differences in the meta data elements known by the plugin and the `DmtAdmin` then the plugin specific elements take precedence.

Note, that a node does not have to exist for having meta-data associated with it. This method may provide meta-data for any node that can possibly exist in the tree (any node defined in the specification). For nodes that are not defined, it may throw `DmtException` with the error code `NODE_NOT_FOUND`. To allow easier implementation of plugins that do not provide meta-data, it is allowed to return null for any node, regardless of whether it is defined or not.

*Returns* a `MetaNode` which describes meta data information, can be null if there is no meta data available for the given node

*Throws* `DmtException`– with the following possible error codes:

- `INVALID_URI` if `nodeUri` is null or syntactically invalid
- `URI_TOO_LONG` if `nodeUri` is longer than accepted by the `DmtAdmin` implementation (especially on systems with limited resources)
- `NODE_NOT_FOUND` if `nodeUri` points to a node that is not defined in the tree (see above)
- `PERMISSION_DENIED` if the session is associated with a principal and the ACL of the node does not allow the `Get` operation for the associated principal
- `DATA_STORE_FAILURE` if an error occurred while accessing the data store
- `COMMAND_FAILED` if the URI is not within the current session's subtree, or if some unspecified error is encountered while attempting to complete the command

`DmtIllegalStateException`– if the session is already closed or invalidated

`SecurityException`– if the caller does not have the necessary permissions to execute the underlying management operation, or, in case of local sessions, if the caller does not have `DmtPermission` for the node with the `Get` action present

#### 117.14.10.22 **public Acl getNodeAcl(String nodeUri) throws DmtException**

*nodeUri* the URI of the node

- Get the Access Control List associated with a given node. The returned `Acl` object does not take inheritance into account, it gives the ACL specifically given to the node.

*Returns* the Access Control List belonging to the node or null if none defined

*Throws* `DmtException`– with the following possible error codes:

- `INVALID_URI` if `nodeUri` is null or syntactically invalid
- `URI_TOO_LONG` if `nodeUri` is longer than accepted by the `DmtAdmin` implementation (especially on systems with limited resources)
- `NODE_NOT_FOUND` if `nodeUri` points to a non-existing node
- `PERMISSION_DENIED` if the session is associated with a principal and the ACL of the node does not allow the `Get` operation for the associated principal
- `METADATA_MISMATCH` if node information cannot be retrieved according to the meta-data (the node does not have `MetaNode.CMD_GET` access type)
- `DATA_STORE_FAILURE` if an error occurred while accessing the data store
- `COMMAND_FAILED` if the URI is not within the current session's subtree, or if some unspecified error is encountered while attempting to complete the command

`DmtIllegalStateException`– if the session is already closed or invalidated

`SecurityException`– in case of local sessions, if the caller does not have `DmtPermission` for the node with the `Get` action present

*See Also* `getEffectiveNodeAcl(String)`

#### 117.14.10.23 **public int getNodeSize(String nodeUri) throws DmtException**

*nodeUri* the URI of the leaf node

- Get the size of the data in a leaf node. The returned value depends on the format of the data in the node, see the description of the `DmtData.getSize()` method for the definition of node size for each format.

*Returns* the size of the data in the node

*Throws* `DmtException`– with the following possible error codes:

- `INVALID_URI` if `nodeUri` is null or syntactically invalid
- `URI_TOO_LONG` if `nodeUri` is longer than accepted by the `DmtAdmin` implementation (especially on systems with limited resources)
- `NODE_NOT_FOUND` if `nodeUri` points to a non-existing node
- `PERMISSION_DENIED` if the session is associated with a principal and the ACL of the node does not allow the Get operation for the associated principal
- `COMMAND_NOT_ALLOWED` if the specified node is not a leaf node
- `METADATA_MISMATCH` if node information cannot be retrieved according to the meta-data (it does not have `MetaNode.CMD_GET` access type)
- `FEATURE_NOT_SUPPORTED` if the Size property is not supported by the `DmtAdmin` implementation or the underlying plugin
- `DATA_STORE_FAILURE` if an error occurred while accessing the data store
- `COMMAND_FAILED` if the URI is not within the current session's subtree, or if some unspecified error is encountered while attempting to complete the command

`DmtIllegalStateException`– if the session is already closed or invalidated

`SecurityException`– if the caller does not have the necessary permissions to execute the underlying management operation, or, in case of local sessions, if the caller does not have `DmtPermission` for the node with the Get action present

*See Also* `DmtData.getSize()`

#### **117.14.10.24**     **public Date getNodeTimestamp(String nodeUri) throws DmtException**

*nodeUri* the URI of the node

- Get the timestamp when the node was created or last modified.

*Returns* the timestamp of the last modification

*Throws* `DmtException`– with the following possible error codes:

- `INVALID_URI` if `nodeUri` is null or syntactically invalid
- `URI_TOO_LONG` if `nodeUri` is longer than accepted by the `DmtAdmin` implementation (especially on systems with limited resources)
- `NODE_NOT_FOUND` if `nodeUri` points to a non-existing node
- `PERMISSION_DENIED` if the session is associated with a principal and the ACL of the node does not allow the Get operation for the associated principal
- `METADATA_MISMATCH` if node information cannot be retrieved according to the meta-data (it does not have `MetaNode.CMD_GET` access type)
- `FEATURE_NOT_SUPPORTED` if the Timestamp property is not supported by the `DmtAdmin` implementation or the underlying plugin
- `DATA_STORE_FAILURE` if an error occurred while accessing the data store
- `COMMAND_FAILED` if the URI is not within the current session's subtree, or if some unspecified error is encountered while attempting to complete the command

`DmtIllegalStateException`– if the session is already closed or invalidated



SecurityException– if the caller does not have the necessary permissions to execute the underlying management operation, or, in case of local sessions, if the caller does not have DmtPermission for the node with the Get action present

**117.14.10.25 public String getNodeTitle(String nodeUri) throws DmtException**

*nodeUri* the URI of the node

- Get the title of a node. There might be no title property set for a node.

*Returns* the title of the node, or null if the node has no title

*Throws* DmtException– with the following possible error codes:

- INVALID\_URI if *nodeUri* is null or syntactically invalid
- URI\_TOO\_LONG if *nodeUri* is longer than accepted by the DmtAdmin implementation (especially on systems with limited resources)
- NODE\_NOT\_FOUND if *nodeUri* points to a non-existing node
- PERMISSION\_DENIED if the session is associated with a principal and the ACL of the node does not allow the Get operation for the associated principal
- METADATA\_MISMATCH if node information cannot be retrieved according to the meta-data (it does not have MetaNode.CMD\_GET access type)
- FEATURE\_NOT\_SUPPORTED if the Title property is not supported by the DmtAdmin implementation or the underlying plugin
- DATA\_STORE\_FAILURE if an error occurred while accessing the data store
- COMMAND\_FAILED if the URI is not within the current session's subtree, or if some unspecified error is encountered while attempting to complete the command

DmtIllegalStateException– if the session is already closed or invalidated

SecurityException– if the caller does not have the necessary permissions to execute the underlying management operation, or, in case of local sessions, if the caller does not have DmtPermission for the node with the Get action present

**117.14.10.26 public String getNodeType(String nodeUri) throws DmtException**

*nodeUri* the URI of the node

- Get the type of a node. The type of leaf node is the MIME type of the data it contains. The type of an interior node is a URI identifying a DDF document; a null type means that there is no DDF document overriding the tree structure defined by the ancestors.

*Returns* the type of the node, can be null

*Throws* DmtException– with the following possible error codes:

- INVALID\_URI if *nodeUri* is null or syntactically invalid
- URI\_TOO\_LONG if *nodeUri* is longer than accepted by the DmtAdmin implementation (especially on systems with limited resources)
- NODE\_NOT\_FOUND if *nodeUri* points to a non-existing node
- PERMISSION\_DENIED if the session is associated with a principal and the ACL of the node does not allow the Get operation for the associated principal
- METADATA\_MISMATCH if node information cannot be retrieved according to the meta-data (it does not have MetaNode.CMD\_GET access type)
- DATA\_STORE\_FAILURE if an error occurred while accessing the data store
- COMMAND\_FAILED if the URI is not within the current session's subtree, or if some unspecified error is encountered while attempting to complete the command

DmtIllegalStateException– if the session is already closed or invalidated

SecurityException– if the caller does not have the necessary permissions to execute the underlying management operation, or, in case of local sessions, if the caller does not have DmtPermission for the node with the Get action present

**117.14.10.27 public DmtData getNodeValue(String nodeUri) throws DmtException**

*nodeUri* the URI of the node to retrieve

- Get the data contained in a leaf or interior node. When retrieving the value associated with an interior node, the caller must have rights to read all nodes in the subtree under the given node.

*Returns* the data of the node, can not be null

*Throws* DmtException– with the following possible error codes:

- INVALID\_URI if *nodeUri* is null or syntactically invalid
- URI\_TOO\_LONG if *nodeUri* is longer than accepted by the DmtAdmin implementation (especially on systems with limited resources)
- NODE\_NOT\_FOUND if *nodeUri* points to a non-existing node
- PERMISSION\_DENIED if the session is associated with a principal and the ACL of the node (and the ACLs of all its descendants in case of interior nodes) do not allow the Get operation for the associated principal
- METADATA\_MISMATCH if the node value cannot be retrieved according to the meta-data (it does not have MetaNode.CMD\_GET access type)
- FEATURE\_NOT\_SUPPORTED if the specified node is an interior node and does not support Java object values
- DATA\_STORE\_FAILURE if an error occurred while accessing the data store
- COMMAND\_FAILED if the URI is not within the current session's subtree, or if some unspecified error is encountered while attempting to complete the command

DmtIllegalStateException– if the session is already closed or invalidated

SecurityException– if the caller does not have the necessary permissions to execute the underlying management operation, or, in case of local sessions, if the caller does not have DmtPermission for the node (and all its descendants in case of interior nodes) with the Get action present

**117.14.10.28 public int getNodeVersion(String nodeUri) throws DmtException**

*nodeUri* the URI of the node

- Get the version of a node. The version can not be set, it is calculated automatically by the device. It is incremented modulo 0x10000 at every modification of the value or any other property of the node, for both leaf and interior nodes. When a node is created the initial value is 0.

*Returns* the version of the node

*Throws* DmtException– with the following possible error codes:

- INVALID\_URI if *nodeUri* is null or syntactically invalid
- URI\_TOO\_LONG if *nodeUri* is longer than accepted by the DmtAdmin implementation (especially on systems with limited resources)
- NODE\_NOT\_FOUND if *nodeUri* points to a non-existing node
- PERMISSION\_DENIED if the session is associated with a principal and the ACL of the node does not allow the Get operation for the associated principal
- METADATA\_MISMATCH if node information cannot be retrieved according to the meta-data (it does not have MetaNode.CMD\_GET access type)
- FEATURE\_NOT\_SUPPORTED if the Version property is not supported by the DmtAdmin implementation or the underlying plugin
- DATA\_STORE\_FAILURE if an error occurred while accessing the data store

- `COMMAND_FAILED` if the URI is not within the current session's subtree, or if some unspecified error is encountered while attempting to complete the command

`DmtIllegalStateException`– if the session is already closed or invalidated

`SecurityException`– if the caller does not have the necessary permissions to execute the underlying management operation, or, in case of local sessions, if the caller does not have `DmtPermission` for the node with the Get action present

**117.14.10.29      `public String getPrincipal()`**

- Gives the name of the principal on whose behalf the session was created. Local sessions do not have an associated principal, in this case null is returned.

*Returns* the identifier of the remote server that initiated the session, or null for local sessions

**117.14.10.30      `public String getRootUri()`**

- Get the root URI associated with this session. Gives "." if the session was created without specifying a root, which means that the target of this session is the whole DMT.

*Returns* the root URI

**117.14.10.31      `public int getSessionId()`**

- The unique identifier of the session. The ID is generated automatically, and it is guaranteed to be unique on a machine for a specific Dmt Admin. A session id must be larger than 0.

*Returns* the session identification number

**117.14.10.32      `public int getState()`**

- Get the current state of this session.

*Returns* the state of the session, one of `STATE_OPEN`, `STATE_CLOSED` and `STATE_INVALID`

**117.14.10.33      `public boolean isLeafNode(String nodeUri) throws DmtException`**

*nodeUri* the URI of the node

- Tells whether a node is a leaf or an interior node of the DMT.

*Returns* true if the given node is a leaf node

*Throws* `DmtException`– with the following possible error codes:

- `INVALID_URI` if `nodeUri` is null or syntactically invalid
- `URI_TOO_LONG` if `nodeUri` is longer than accepted by the `DmtAdmin` implementation (especially on systems with limited resources)
- `NODE_NOT_FOUND` if `nodeUri` points to a non-existing node
- `PERMISSION_DENIED` if the session is associated with a principal and the ACL of the node does not allow the Get operation for the associated principal
- `METADATA_MISMATCH` if node information cannot be retrieved according to the meta-data (it does not have `MetaNode.CMD_GET` access type)
- `DATA_STORE_FAILURE` if an error occurred while accessing the data store
- `COMMAND_FAILED` if the URI is not within the current session's subtree, or if some unspecified error is encountered while attempting to complete the command

`DmtIllegalStateException`– if the session is already closed or invalidated

`SecurityException`– if the caller does not have the necessary permissions to execute the underlying management operation, or, in case of local sessions, if the caller does not have `DmtPermission` for the node with the Get action present

**117.14.10.34 public boolean isNodeUri(String nodeUri)***nodeUri* the URI to check

- Check whether the specified URI corresponds to a valid node in the DMT.

*Returns* true if the given node exists in the DMT*Throws* `DmtIllegalStateException`– if the session is already closed or invalidated

`SecurityException`– if the caller does not have the necessary permissions to execute the underlying management operation, or, in case of local sessions, if the caller does not have `DmtPermission` for the node with the Get action present

**117.14.10.35 public void renameNode(String nodeUri,String newName) throws DmtException***nodeUri* the URI of the node to rename*newName* the new name property of the node

- Rename a node. This operation only changes the name of the node (updating the timestamp and version properties if they are supported), the value and the other properties are not changed. The new name of the node must be provided, the new URI is constructed from the base of the old URI and the given name. It is not allowed to rename the root node of the session.

If available, the meta-data of the original and the new nodes are checked before performing the rename operation. Neither node can be permanent, their leaf/interior property must match, and the name change must not violate any of the cardinality constraints. The original node must have the `MetaNode.CMD_REPLACE` access type, and the name of the new node must conform to the valid names.

*Throws* `DmtException`– with the following possible error codes:

- `INVALID_URI` if `nodeUri` or `newName` is null or syntactically invalid
- `URI_TOO_LONG` if `nodeUri` is longer than accepted by the `DmtAdmin` implementation (especially on systems with limited resources)
- `NODE_NOT_FOUND` if `nodeUri` points to a non-existing node, or if the new node is not defined in the tree according to the meta-data (see `getMetaNode(String)`)
- `NODE_ALREADY_EXISTS` if there already exists a sibling of `nodeUri` with the name `newName`
- `PERMISSION_DENIED` if the session is associated with a principal and the ACL of the node does not allow the Replace operation for the associated principal
- `COMMAND_NOT_ALLOWED` if the target node is the root of the session, or in non-atomic sessions if the underlying plugin is read-only or does not support non-atomic writing
- `METADATA_MISMATCH` if the node could not be renamed because of meta-data restrictions (see above)
- `TRANSACTION_ERROR` in an atomic session if the underlying plugin is read-only or does not support atomic writing
- `DATA_STORE_FAILURE` if an error occurred while accessing the data store
- `COMMAND_FAILED` if the URI is not within the current session's subtree, or if some unspecified error is encountered while attempting to complete the command

`DmtIllegalStateException`– if the session was opened using the `LOCK_TYPE_SHARED` lock type, or if the session is already closed or invalidated

`SecurityException`– if the caller does not have the necessary permissions to execute the underlying management operation, or, in case of local sessions, if the caller does not have `DmtPermission` for the node with the Replace action present

**117.14.10.36 public void rollback() throws DmtException**

- Rolls back a series of DMT operations issued in the current atomic session since the last transaction boundary. Transaction boundaries are the creation of this object that starts the session, and all subsequent commit() and rollback() calls.

*Throws* DmtException– with the error code ROLLBACK\_FAILED in case the rollback did not succeed

DmtIllegalStateException– if the session was not opened using the LOCK\_TYPE\_ATOMIC lock type, or if the session is already closed or invalidated

SecurityException– if the caller does not have the necessary permissions to execute the underlying management operation

**117.14.10.37 public void setDefaultNodeValue(String nodeUri) throws DmtException**

*nodeUri* the URI of the node

- Set the value of a leaf or interior node to its default. The default can be defined by the node's MetaNode. The method throws a METADATA\_MISMATCH exception if the node does not have a default value.

*Throws* DmtException– with the following possible error codes:

- INVALID\_URI if nodeUri is null or syntactically invalid
- URI\_TOO\_LONG if nodeUri is longer than accepted by the DmtAdmin implementation (especially on systems with limited resources)
- NODE\_NOT\_FOUND if nodeUri points to a non-existing node
- PERMISSION\_DENIED if the session is associated with a principal and the ACL of the node does not allow the Replace operation for the associated principal
- COMMAND\_NOT\_ALLOWED in non-atomic sessions if the underlying plugin is read-only or does not support non-atomic writing
- METADATA\_MISMATCH if the node is permanent or cannot be modified according to the metadata (does not have the MetaNode.CMD\_REPLACE access type), or if there is no default value defined for this node
- FEATURE\_NOT\_SUPPORTED if the specified node is an interior node and does not support Java object values
- TRANSACTION\_ERROR in an atomic session if the underlying plugin is read-only or does not support atomic writing
- DATA\_STORE\_FAILURE if an error occurred while accessing the data store
- COMMAND\_FAILED if the URI is not within the current session's subtree, or if some unspecified error is encountered while attempting to complete the command

DmtIllegalStateException– if the session was opened using the LOCK\_TYPE\_SHARED lock type, or if the session is already closed or invalidated

SecurityException– if the caller does not have the necessary permissions to execute the underlying management operation, or, in case of local sessions, if the caller does not have DmtPermission for the node with the Replace action present

*See Also* setNodeValue(String, DmtData)

**117.14.10.38 public void setNodeAcl(String nodeUri, Acl acl) throws DmtException**

*nodeUri* the URI of the node

*acl* the Access Control List to be set on the node, can be null

- Set the Access Control List associated with a given node. To perform this operation, the caller needs to have replace rights (Acl.REPLACE or the corresponding Java permission depending on the session type) as described below:

- if `nodeUri` specifies a leaf node, replace rights are needed on the parent of the node
- if `nodeUri` specifies an interior node, replace rights on either the node or its parent are sufficient

If the given `acl` is null or an empty ACL (not specifying any permissions for any principals), then the ACL of the node is deleted, and the node will inherit the ACL from its parent node.

*Throws* `DmtException`– with the following possible error codes:

- `INVALID_URI` if `nodeUri` is null or syntactically invalid
- `URI_TOO_LONG` if `nodeUri` is longer than accepted by the `DmtAdmin` implementation (especially on systems with limited resources)
- `NODE_NOT_FOUND` if `nodeUri` points to a non-existing node
- `PERMISSION_DENIED` if the session is associated with a principal and the ACL of the node or its parent (see above) does not allow the `Replace` operation for the associated principal
- `COMMAND_NOT_ALLOWED` if the command attempts to set the ACL of the root node not to include `Add` rights for all principals
- `DATA_STORE_FAILURE` if an error occurred while accessing the data store
- `COMMAND_FAILED` if the URI is not within the current session's subtree, or if some unspecified error is encountered while attempting to complete the command

`DmtIllegalStateException`– if the session was opened using the `LOCK_TYPE_SHARED` lock type, or if the session is already closed or invalidated

`SecurityException`– in case of local sessions, if the caller does not have `DmtPermission` for the node or its parent (see above) with the `Replace` action present

#### **117.14.10.39**     **public void setNodeTitle(String nodeUri,String title) throws DmtException**

*nodeUri* the URI of the node

*title* the title text of the node, can be null

- Set the title property of a node. The length of the title string in UTF-8 encoding must not exceed 255 bytes.

*Throws* `DmtException`– with the following possible error codes:

- `INVALID_URI` if `nodeUri` is null or syntactically invalid
- `URI_TOO_LONG` if `nodeUri` is longer than accepted by the `DmtAdmin` implementation (especially on systems with limited resources)
- `NODE_NOT_FOUND` if `nodeUri` points to a non-existing node
- `PERMISSION_DENIED` if the session is associated with a principal and the ACL of the node does not allow the `Replace` operation for the associated principal
- `COMMAND_NOT_ALLOWED` in non-atomic sessions if the underlying plugin is read-only or does not support non-atomic writing
- `METADATA_MISMATCH` if the node cannot be modified according to the meta-data (does not have the `MetaNode.CMD_REPLACE` access type)
- `FEATURE_NOT_SUPPORTED` if the `Title` property is not supported by the `DmtAdmin` implementation or the underlying plugin
- `TRANSACTION_ERROR` in an atomic session if the underlying plugin is read-only or does not support atomic writing
- `DATA_STORE_FAILURE` if an error occurred while accessing the data store
- `COMMAND_FAILED` if the title string is too long, if the URI is not within the current session's subtree, or if some unspecified error is encountered while attempting to complete the command

`DmtIllegalStateException`– if the session was opened using the `LOCK_TYPE_SHARED` lock type, or if the session is already closed or invalidated

SecurityException– if the caller does not have the necessary permissions to execute the underlying management operation, or, in case of local sessions, if the caller does not have DmtPermission for the node with the Replace action present

**117.14.10.40 public void setNodeType(String nodeUri,String type) throws DmtException**

*nodeUri* the URI of the node

*type* the type of the node, can be null

- Set the type of a node. The type of leaf node is the MIME type of the data it contains. The type of an interior node is a URI identifying a DDF document.

For interior nodes, a null type string means that there is no DDF document overriding the tree structure defined by the ancestors. For leaf nodes, it requests that the default MIME type is used for the given node. If the node does not have a default MIME type this method will throw a DmtException with error code METADATA\_MISMATCH. Note that a node might have a default MIME type even if there is no meta-data for the node or its meta-data does not specify the default.

MIME types must conform to the definition in RFC 2045. Interior node type identifiers must follow the format defined in section 7.7.7.2 of the OMA Device Management Tree and Description document. Checking the validity of the type string does not have to be done by the DmtAdmin, this can be left to the plugin handling the node (if any), to avoid unnecessary double-checks.

*Throws* DmtException– with the following possible error codes:

- INVALID\_URI if nodeUri is null or syntactically invalid
- URI\_TOO\_LONG if nodeUri is longer than accepted by the DmtAdmin implementation (especially on systems with limited resources)
- NODE\_NOT\_FOUND if nodeUri points to a non-existing node
- PERMISSION\_DENIED if the session is associated with a principal and the ACL of the node does not allow the Replace operation for the associated principal
- COMMAND\_NOT\_ALLOWED in non-atomic sessions if the underlying plugin is read-only or does not support non-atomic writing
- METADATA\_MISMATCH if the node is permanent or cannot be modified according to the meta-data (does not have the MetaNode.CMD\_REPLACE access type), and in case of leaf nodes, if null is given and there is no default MIME type, or the given MIME type is not allowed
- TRANSACTION\_ERROR in an atomic session if the underlying plugin is read-only or does not support atomic writing
- DATA\_STORE\_FAILURE if an error occurred while accessing the data store
- COMMAND\_FAILED if the URI is not within the current session's subtree, if the type string is invalid (see above), or if some unspecified error is encountered while attempting to complete the command

DmtIllegalStateException– if the session was opened using the LOCK\_TYPE\_SHARED lock type, or if the session is already closed or invalidated

SecurityException– if the caller does not have the necessary permissions to execute the underlying management operation, or, in case of local sessions, if the caller does not have DmtPermission for the node with the Replace action present

*See Also* RFC 2045 [<http://www.ietf.org/rfc/rfc2045.txt>], OMA Device Management Tree and Description v1.2 draft [[http://member.openmobilealliance.org/ftp/public\\_documents/dm/Permanent\\_documents/OMA-TS-DM-TND-V1\\_2-20050615-C.zip](http://member.openmobilealliance.org/ftp/public_documents/dm/Permanent_documents/OMA-TS-DM-TND-V1_2-20050615-C.zip)]

**117.14.10.41 public void setNodeValue(String nodeUri,DmtData data) throws DmtException**

*nodeUri* the URI of the node

*data* the data to be set, can be null

- Set the value of a leaf or interior node. The format of the node is contained in the `DmtData` object. For interior nodes, the format must be `FORMAT_NODE`, while for leaf nodes this format must not be used.

If the specified value is null, the default value is taken. In this case, if the node does not have a default value, this method will throw a `DmtException` with error code `METADATA_MISMATCH`. Nodes of null format can be set by using `DmtData.NULL_VALUE` as second argument.

An Event of type `REPLACE` is sent out for a leaf node. A replaced interior node sends out events for each of its children in depth first order and node names sorted with `Arrays.sort(String[])`. When setting a value on an interior node, the values of the leaf nodes under it can change, but the structure of the subtree is not modified by the operation.

*Throws* `DmtException`— with the following possible error codes:

- `INVALID_URI` if `nodeUri` is null or syntactically invalid
- `URI_TOO_LONG` if `nodeUri` is longer than accepted by the `DmtAdmin` implementation (especially on systems with limited resources)
- `NODE_NOT_FOUND` if `nodeUri` points to a non-existing node
- `PERMISSION_DENIED` if the session is associated with a principal and the ACL of the node does not allow the `Replace` operation for the associated principal
- `COMMAND_NOT_ALLOWED` if the given data has `FORMAT_NODE` format but the node is a leaf node (or vice versa), or in non-atomic sessions if the underlying plugin is read-only or does not support non-atomic writing
- `METADATA_MISMATCH` if the node is permanent or cannot be modified according to the meta-data (does not have the `MetaNode.CMD_REPLACE` access type), or if the given value does not conform to the meta-data value constraints
- `FEATURE_NOT_SUPPORTED` if the specified node is an interior node and does not support Java object values
- `TRANSACTION_ERROR` in an atomic session if the underlying plugin is read-only or does not support atomic writing
- `DATA_STORE_FAILURE` if an error occurred while accessing the data store
- `COMMAND_FAILED` if the URI is not within the current session's subtree, or if some unspecified error is encountered while attempting to complete the command

`DmtIllegalStateException`— if the session was opened using the `LOCK_TYPE_SHARED` lock type, or if the session is already closed or invalidated

`SecurityException`— if the caller does not have the necessary permissions to execute the underlying management operation, or, in case of local sessions, if the caller does not have `DmtPermission` for the node with the `Replace` action present

### 117.14.11 public interface `MetaNode`

The `MetaNode` contains meta data as standardized by OMA DM but extends it (without breaking the compatibility) to provide for better DMT data quality in an environment where many software components manipulate this data.

The interface has several types of functions to describe the nodes in the DMT. Some methods can be used to retrieve standard OMA DM metadata such as access type, cardinality, default, etc., others are for data extensions such as valid names and values. In some cases the standard behavior has been extended, for example it is possible to provide several valid MIME types, or to differentiate between normal and automatic dynamic nodes.

Most methods in this interface receive no input, just return information about some aspect of the node. However, there are two methods that behave differently, `isValidName(String)` and `isValidValue(DmtData)`. These validation methods are given a potential node name or value (respectively), and can decide whether it is valid for the given node. Passing the validation methods is a nec-



essary condition for a name or value to be used, but it is not necessarily sufficient: the plugin may carry out more thorough (more expensive) checks when the node is actually created or set.

If a `MetaNode` is available for a node, the `DmtAdmin` must use the information provided by it to filter out invalid requests on that node. However, not all methods on this interface are actually used for this purpose, as many of them (e.g. `getFormat()` or `getValidNames()`) can be substituted with the validating methods. For example, `isValidValue(DmtData)` can be expected to check the format, minimum, maximum, etc. of a given value, making it unnecessary for the `DmtAdmin` to call `getFormat()`, `getMin()`, `getMax()` etc. separately. It is indicated in the description of each method if the `DmtAdmin` does not enforce the constraints defined by it - such methods are only for external use, for example in user interfaces.

Most of the methods of this class return null if a certain piece of meta information is not defined for the node or providing this information is not supported. Methods of this class do not throw exceptions.

**117.14.11.1      `public static final int AUTOMATIC = 2`**

Constant for representing an automatic node in the tree. This must be returned by `getScope()`. AUTOMATIC nodes are part of the life cycle of their parent node, they usually describe attributes/properties of the parent.

**117.14.11.2      `public static final int CMD_ADD = 0`**

Constant for the ADD access type. If `can(int)` returns true for this operation, this node can potentially be added to its parent. Nodes with PERMANENT or AUTOMATIC scope typically do not have this access type.

**117.14.11.3      `public static final int CMD_DELETE = 1`**

Constant for the DELETE access type. If `can(int)` returns true for this operation, the node can potentially be deleted.

**117.14.11.4      `public static final int CMD_EXECUTE = 2`**

Constant for the EXECUTE access type. If `can(int)` returns true for this operation, the node can potentially be executed.

**117.14.11.5      `public static final int CMD_GET = 4`**

Constant for the GET access type. If `can(int)` returns true for this operation, the value, the list of child nodes (in case of interior nodes) and the properties of the node can potentially be retrieved.

**117.14.11.6      `public static final int CMD_REPLACE = 3`**

Constant for the REPLACE access type. If `can(int)` returns true for this operation, the value and other properties of the node can potentially be modified.

**117.14.11.7      `public static final int DYNAMIC = 1`**

Constant for representing a dynamic node in the tree. This must be returned by `getScope()`. Dynamic nodes can be added and deleted.

**117.14.11.8      `public static final int PERMANENT = 0`**

Constant for representing a PERMANENT node in the tree. This must be returned by `getScope()` if the node cannot be added, deleted or modified in any way through tree operations. PERMANENT nodes in general map to the roots of Plugins.

**117.14.11.9      `public boolean can(int operation)`**

*operation* One of the `MetaNode.CMD_...` constants.

- Check whether the given operation is valid for this node. If no meta-data is provided for a node, all operations are valid.

*Returns* false if the operation is not valid for this node or the operation code is not one of the allowed constants

#### 117.14.11.10 **public DmtData getDefault()**

- Get the default value of this node if any.

*Returns* The default value or null if not defined

#### 117.14.11.11 **public String getDescription()**

- Get the explanation string associated with this node. Can be null if no description is provided for this node.

*Returns* node description string or null for no description

#### 117.14.11.12 **public Object getExtensionProperty(String key)**

*key* the key for the extension property

- Returns the value for the specified extension property key. This method only works if the provider of this MetaNode provides proprietary extensions to node meta data.

*Returns* the value of the requested property, cannot be null

*Throws* IllegalArgumentException– if the specified key is not supported by this MetaNode

#### 117.14.11.13 **public String[] getExtensionPropertyKeys()**

- Returns the list of extension property keys, if the provider of this MetaNode provides proprietary extensions to node meta data. The method returns null if the node doesn't provide such extensions.

*Returns* the array of supported extension property keys

#### 117.14.11.14 **public int getFormat()**

- Get the node's format, expressed in terms of type constants defined in DmtData. If there are multiple formats allowed for the node then the format constants are OR-ed. Interior nodes must have DmtData.FORMAT\_NODE format, and this code must not be returned for leaf nodes. If no meta-data is provided for a node, all applicable formats are considered valid (with the above constraints regarding interior and leaf nodes).

Note that the 'format' term is a legacy from OMA DM, it is more customary to think of this as 'type'.

The formats returned by this method are not checked by DmtAdmin, they are only for external use, for example in user interfaces. DmtAdmin only calls isValidValue(DmtData) for checking the value, its behavior should be consistent with this method.

*Returns* the allowed format(s) of the node

#### 117.14.11.15 **public double getMax()**

- Get the maximum allowed value associated with a node of numeric format. If no meta-data is provided for a node, there is no upper limit to its value. This method is only meaningful if the node has one of the numeric formats: integer, float, or long format. The returned limit has double type, as this can be used to denote all numeric limits with full precision. The actual maximum should be the largest integer, float or long number that does not exceed the returned value.

The information returned by this method is not checked by DmtAdmin, it is only for external use, for example in user interfaces. DmtAdmin only calls isValidValue(DmtData) for checking the value, its behavior should be consistent with this method.

*Returns* the allowed maximum, or Double.MAX\_VALUE if there is no upper limit defined or the node's format is not one of the numeric formats integer, float, or long

**117.14.11.16      public int getMaxOccurrence()**

- Get the number of maximum occurrences of this type of nodes on the same level in the DMT. Returns `Integer.MAX_VALUE` if there is no upper limit. Note that if the occurrence is greater than 1 then this node can not have siblings with different metadata. In other words, if different types of nodes coexist on the same level, their occurrence can not be greater than 1. If no meta-data is provided for a node, there is no upper limit on the number of occurrences.

*Returns* The maximum allowed occurrence of this node type

**117.14.11.17      public String[] getMimeTypees()**

- Get the list of MIME types this node can hold. The first element of the returned list must be the default MIME type.

All MIME types are considered valid if no meta-data is provided for a node or if null is returned by this method. In this case the default MIME type cannot be retrieved from the meta-data, but the node may still have a default. This hidden default (if it exists) can be utilized by passing null as the type parameter of `DmtSession.setNodeType(String, String)` or `DmtSession.createLeafNode(String, DmtData, String)`.

*Returns* the list of allowed MIME types for this node, starting with the default MIME type, or null if all types are allowed

**117.14.11.18      public double getMin()**

- Get the minimum allowed value associated with a node of numeric format. If no meta-data is provided for a node, there is no lower limit to its value. This method is only meaningful if the node has one of the numeric formats: integer, float, or long format. The returned limit has double type, as this can be used to denote both integer and float limits with full precision. The actual minimum should be the smallest integer, float or long value that is equal or larger than the returned value.

The information returned by this method is not checked by `DmtAdmin`, it is only for external use, for example in user interfaces. `DmtAdmin` only calls `isValidValue(DmtData)` for checking the value, its behavior should be consistent with this method.

*Returns* the allowed minimum, or `Double.MIN_VALUE` if there is no lower limit defined or the node's format is not one of the numeric formats integer, float, or long

**117.14.11.19      public String[] getRawFormatNames()**

- Get the format names for any raw formats supported by the node. This method is only meaningful if the list of supported formats returned by `getFormat()` contains `DmtData.FORMAT_RAW_STRING` or `DmtData.FORMAT_RAW_BINARY`: it specifies precisely which raw format(s) are actually supported. If the node cannot contain data in one of the raw types, this method must return null.

The format names returned by this method are not checked by `DmtAdmin`, they are only for external use, for example in user interfaces. `DmtAdmin` only calls `isValidValue(DmtData)` for checking the value, its behavior should be consistent with this method.

*Returns* the allowed format name(s) of raw data stored by the node, or null if raw formats are not supported

**117.14.11.20      public int getScope()**

- Return the scope of the node. Valid values are `MetaNode.PERMANENT`, `MetaNode.DYNAMIC` and `MetaNode.AUTOMATIC`. Note that a permanent node is not the same as a node where the DELETE operation is not allowed. Permanent nodes never can be deleted, whereas a non-deletable node can disappear in a recursive DELETE operation issued on one of its parents. If no meta-data is provided for a node, it can be assumed to be a dynamic node.

*Returns* `PERMANENT` for permanent nodes, `AUTOMATIC` for nodes that are automatically created, and `DYNAMIC` otherwise

**117.14.11.21 public String[] getValidNames()**

- Return an array of Strings if valid names are defined for the node, or null if no valid name list is defined or if this piece of meta info is not supported. If no meta-data is provided for a node, all names are considered valid.

The information returned by this method is not checked by DmtAdmin, it is only for external use, for example in user interfaces. DmtAdmin only calls isValidName(String) for checking the name, its behavior should be consistent with this method.

*Returns* the valid values for this node name, or null if not defined

**117.14.11.22 public DmtData[] getValidValues()**

- Return an array of DmtData objects if valid values are defined for the node, or null otherwise. If no meta-data is provided for a node, all values are considered valid.

The information returned by this method is not checked by DmtAdmin, it is only for external use, for example in user interfaces. DmtAdmin only calls isValidValue(DmtData) for checking the value, its behavior should be consistent with this method.

*Returns* the valid values for this node, or null if not defined

**117.14.11.23 public boolean isLeaf()**

- Check whether the node is a leaf node or an internal one.

*Returns* true if the node is a leaf node

**117.14.11.24 public boolean isValidName(String name)**

*name* the node name to check for validity

- Checks whether the given name is a valid name for this node. This method can be used for example to ensure that the node name is always one of a predefined set of valid names, or that it matches a specific pattern. This method should be consistent with the values returned by getValidNames() (if any), the DmtAdmin only calls this method for name validation.

This method may return true even if not all aspects of the name have been checked, expensive operations (for example those that require external resources) need not be performed here. The actual node creation may still indicate that the node name is invalid.

*Returns* false if the specified name is found to be invalid for the node described by this meta-node, true otherwise

**117.14.11.25 public boolean isValidValue(DmtData value)**

*value* the value to check for validity

- Checks whether the given value is valid for this node. This method can be used to ensure that the value has the correct format and range, that it is well formed, etc. This method should be consistent with the constraints defined by the getFormat(), getValidValues(), getMin() and getMax() methods (if applicable), as the Dmt Admin only calls this method for value validation.

This method may return true even if not all aspects of the value have been checked, expensive operations (for example those that require external resources) need not be performed here. The actual value setting method may still indicate that the value is invalid.

*Returns* false if the specified value is found to be invalid for the node described by this meta-node, true otherwise

**117.14.11.26 public boolean isZeroOccurrenceAllowed()**

- Check whether zero occurrence of this node is valid. If no meta-data is returned for a node, zero occurrences are allowed.

*Returns* true if zero occurrence of this node is valid

### 117.14.12 **public final class Uri**

This class contains static utility methods to manipulate DMT URIs.

Syntax of valid DMT URIs:

- A slash ('/'\u002F) is the separator of the node names. Slashes used in node name must therefore be escaped using a backslash slash ("\/"). The backslash must be escaped with a double backslash sequence. A backslash found must be ignored when it is not followed by a slash or backslash.
- The node name can be constructed using full Unicode character set (except the Supplementary code, not being supported by CLDC/CDC). However, using the full Unicode character set for node names is discouraged because the encoding in the underlying storage as well as the encoding needed in communications can create significant performance and memory usage overhead. Names that are restricted to the URI set [-a-zA-Zo-9\_!~\*'] are most efficient.
- URIs used in the DMT must be treated and interpreted as case sensitive.
- No End Slash: URI must not end with the delimiter slash ('/'\u002F). This implies that the root node must be denoted as "." and not "./".
- No parent denotation: URI must not be constructed using the character sequence "../" to traverse the tree upwards.
- Single Root: The character sequence "./" must not be used anywhere else but in the beginning of a URI.

#### 117.14.12.1 **public static final String PATH\_SEPARATOR = "/"**

This constant stands for a string identifying the path separator in the DmTree ("/").

*Since* 2.0

#### 117.14.12.2 **public static final char PATH\_SEPARATOR\_CHAR = 47**

This constant stands for a char identifying the path separator in the DmTree ('/').

*Since* 2.0

#### 117.14.12.3 **public static final String ROOT\_NODE = ""**

This constant stands for a string identifying the root of the DmTree ("").

*Since* 2.0

#### 117.14.12.4 **public static final char ROOT\_NODE\_CHAR = 46**

This constant stands for a char identifying the root of the DmTree ('.').

*Since* 2.0

#### 117.14.12.5 **public static String decode(String nodeName)**

*nodeName* the node name to be decoded

- Decode the node name so that back slash and forward slash are unescaped from a back slash.

*Returns* the decoded node name

*Since* 2.0

#### 117.14.12.6 **public static String encode(String nodeName)**

*nodeName* the node name to be encoded

- Encode the node name so that back slash and forward slash are escaped with a back slash. This method is the reverse of decode(String).

*Returns* the encoded node name

*Since* 2.0

#### 117.14.12.7 **public static boolean isAbsoluteUri(String uri)**

*uri* the URI to be checked, must not be null and must contain a valid URI

- Checks whether the specified URI is an absolute URI. An absolute URI contains the complete path to a node in the DMT starting from the DMT root ("").

*Returns* whether the specified URI is absolute

*Throws* `NullPointerException`– if the specified URI is null  
`IllegalArgumentException`– if the specified URI is malformed

#### 117.14.12.8 **public static boolean isValidUri(String uri)**

*uri* the URI to be validated

- Checks whether the specified URI is valid. A URI is considered valid if it meets the following constraints:

- the URI is not null;
- the URI follows the syntax defined for valid DMT URIs;

The exact definition of the length of a URI and its segments is given in the descriptions of the `getMaxUriLength()` and `getMaxSegmentNameLength()` methods.

*Returns* whether the specified URI is valid

#### 117.14.12.9 **public static String mangle(String nodeName)**

*nodeName* the node name to be mangled (if necessary), must not be null or empty

- Returns a node name that is valid for the tree operation methods, based on the given node name. This transformation is not idempotent, so it must not be called with a parameter that is the result of a previous mangle method call.

Node name mangling is needed in the following cases:

- if the name contains '/' or '\' characters

A node name that does not suffer from either of these problems is guaranteed to remain unchanged by this method. Therefore the client may skip the mangling if the node name is known to be valid (though it is always safe to call this method).

The method returns the normalized `nodeName` as described below. Invalid node names are normalized in different ways, depending on the cause. If the name contains '/' or '\' characters, then these are simply escaped by inserting an additional '\' before each occurrence. If the length of the name does exceed the limit, the following mechanism is used to normalize it:

- the SHA 1 digest of the name is calculated
- the digest is encoded with the base 64 algorithm
- all '/' characters in the encoded digest are replaced with '\_'
- trailing '=' signs are removed

*Returns* the normalized node name that is valid for tree operations

*Throws* `NullPointerException`– if `nodeName` is null  
`IllegalArgumentException`– if `nodeName` is empty

**117.14.12.10**      **public static String[] toPath(String uri)**

*uri* the URI to be split, must not be null

- Split the specified URI along the path separator '/' characters and return an array of URI segments. Special characters in the returned segments are escaped. The returned array may be empty if the specified URI was empty.

*Returns* an array of URI segments created by splitting the specified URI

*Throws* NullPointerException– if the specified URI is null

IllegalArgumentException– if the specified URI is malformed

**117.14.12.11**      **public static String toUri(String[] path)**

*path* a possibly empty array of URI segments, must not be null

- Construct a URI from the specified URI segments. The segments must already be mangled. If the specified path is an empty array then an empty URI ("") is returned.

*Returns* the URI created from the specified segments

*Throws* NullPointerException– if the specified path or any of its segments are null

IllegalArgumentException– if the specified path contains too many or malformed segments or the resulting URI is too long

## 117.15      org.osgi.service.dmt.spi

Device Management Tree SPI Package Version 2.0.

This package contains the interface classes that compose the Device Management SPI (Service Provider Interface). These interfaces are implemented by DMT plugins; users of the DmtAdmin interface do not interact directly with these.

Bundles wishing to use this package must list the package in the Import-Package header of the bundle's manifest. This package has two types of users: the consumers that use the API in this package and the providers that implement the API in this package.

Example import for consumers using the API in this package:

```
Import-Package: org.osgi.service.dmt.spi; version="[2.0,3.0)"
```

Example import for providers implementing the API in this package:

```
Import-Package: org.osgi.service.dmt.spi; version="[2.0,2.1)"
```

### 117.15.1      Summary

- DataPlugin - An implementation of this interface takes the responsibility of handling data requests in a subtree of the DMT.
- ExecPlugin - An implementation of this interface takes the responsibility of handling node execute requests in a subtree of the DMT.
- MountPlugin - This interface can be optionally implemented by a DataPlugin or ExecPlugin in order to get information about its absolute mount points in the overall DMT.
- MountPoint - This interface can be implemented to represent a single mount point.
- ReadableDataSession - Provides read-only access to the part of the tree handled by the plugin that created this session.
- ReadWriteDataSession - Provides non-atomic read-write access to the part of the tree handled by the plugin that created this session.

- `TransactionalDataSession` - Provides atomic read-write access to the part of the tree handled by the plugin that created this session.

### 117.15.2 public interface `DataPlugin`

An implementation of this interface takes the responsibility of handling data requests in a subtree of the DMT.

In an OSGi environment such implementations should be registered at the OSGi service registry specifying the list of root node URIs in a `String` array or in case of a single value as `String` in the `dataRootURIs` registration parameter.

When the first reference in a session is made to a node handled by this plugin, the `DmtAdmin` calls one of the `open...` methods to retrieve a plugin session object for processing the request. The called method depends on the lock type of the current session. In case of `openReadWriteSession(String[], DmtSession)` and `openAtomicSession(String[], DmtSession)`, the plugin may return null to indicate that the specified lock type is not supported. In this case the `DmtAdmin` may call `openReadOnlySession(String[], DmtSession)` to start a read-only plugin session, which can be used as long as there are no write operations on the nodes handled by this plugin.

The `sessionRoot` parameter of each method is a `String` array containing the segments of the URI pointing to the root of the session. This is an absolute path, so the first segment is always `."`. Special characters appear escaped in the segments.

#### 117.15.2.1 public static final `String DATA_ROOT_URIS = "dataRootURIs"`

The string to be used as key for the `"dataRootURIs"` property when an `DataPlugin` is registered.

*Since* 2.0

#### 117.15.2.2 public static final `String MOUNT_POINTS = "mountPoints"`

The string to be used as key for the mount points property when a `DataPlugin` is registered with mount points.

#### 117.15.2.3 public `TransactionalDataSession openAtomicSession(String[] sessionRoot, DmtSession session)` throws `DmtException`

*sessionRoot* the path to the subtree which is locked in the current session, must not be null

*session* the session from which this plugin instance is accessed, must not be null

- This method is called to signal the start of an atomic read-write session when the first reference is made within a `DmtSession` to a node which is handled by this plugin. Session information is given as it is needed for sending alerts back from the plugin.

The plugin can assume that there are no other sessions open on any subtree that has any overlap with the subtree of this session.

*Returns* a plugin session capable of executing read-write operations in an atomic block, or null if the plugin does not support atomic read-write sessions

*Throws* `DmtException`– with the following possible error codes:

- `NODE_NOT_FOUND` if `sessionRoot` points to a non-existing node
- `COMMAND_FAILED` if some unspecified error is encountered while attempting to complete the command

`SecurityException`– if some underlying operation failed because of lack of permissions

#### 117.15.2.4 public `ReadableDataSession openReadOnlySession(String[] sessionRoot, DmtSession session)` throws `DmtException`

*sessionRoot* the path to the subtree which is accessed in the current session, must not be null



*session* the session from which this plugin instance is accessed, must not be null

- This method is called to signal the start of a read-only session when the first reference is made within a `DmtSession` to a node which is handled by this plugin. Session information is given as it is needed for sending alerts back from the plugin.

The plugin can assume that there are no writing sessions open on any subtree that has any overlap with the subtree of this session.

*Returns* a plugin session capable of executing read operations

*Throws* `DmtException`– with the following possible error codes:

- `NODE_NOT_FOUND` if `sessionRoot` points to a non-existing node
- `COMMAND_FAILED` if some unspecified error is encountered while attempting to complete the command

`SecurityException`– if some underlying operation failed because of lack of permissions

### 117.15.2.5 **public ReadWriteDataSession openReadWriteSession(String[] sessionRoot, DmtSession session) throws DmtException**

*sessionRoot* the path to the subtree which is locked in the current session, must not be null

*session* the session from which this plugin instance is accessed, must not be null

- This method is called to signal the start of a non-atomic read-write session when the first reference is made within a `DmtSession` to a node which is handled by this plugin. Session information is given as it is needed for sending alerts back from the plugin.

The plugin can assume that there are no other sessions open on any subtree that has any overlap with the subtree of this session.

*Returns* a plugin session capable of executing read-write operations, or null if the plugin does not support non-atomic read-write sessions

*Throws* `DmtException`– with the following possible error codes:

- `NODE_NOT_FOUND` if `sessionRoot` points to a non-existing node
- `COMMAND_FAILED` if some unspecified error is encountered while attempting to complete the command

`SecurityException`– if some underlying operation failed because of lack of permissions

### 117.15.3 **public interface ExecPlugin**

An implementation of this interface takes the responsibility of handling node execute requests in a subtree of the DMT.

In an OSGi environment such implementations should be registered at the OSGi service registry specifying the list of root node URIs in a `String` array or in case of a single value as `String` in the `execRootURIs` registration parameter.

#### 117.15.3.1 **public static final String EXEC\_ROOT\_URIS = "execRootURIs"**

The string to be used as key for the “`execRootURIs`” property when an `ExecPlugin` is registered.

*Since* 2.0

#### 117.15.3.2 **public static final String MOUNT\_POINTS = "mountPoints"**

The string to be used as key for the mount points property when an `Exec Plugin` is registered with mount points.

**117.15.3.3 public void execute(DmtSession session,String[] nodePath,String correlator,String data) throws DmtException**

*session* a reference to the session in which the operation was issued, must not be null

*nodePath* the absolute path of the node to be executed, must not be null

*correlator* an identifier to associate this operation with any alerts sent in response to it, can be null

*data* the parameter of the execute operation, can be null

- Execute the given node with the given data. This operation corresponds to the EXEC command in OMA DM.

The semantics of an execute operation and the data parameter it takes depends on the definition of the managed object on which the command is issued. Session information is given as it is needed for sending alerts back from the plugin. If a correlation ID is specified, it should be used as the correlator parameter for alerts sent in response to this execute operation.

The *nodePath* parameter contains an array of path segments identifying the node to be executed in the subtree of this plugin. This is an absolute path, so the first segment is always ".". Special characters appear escaped in the segments.

*Throws* DmtException– with the following possible error codes:

- NODE\_NOT\_FOUND if the node does not exist
- METADATA\_MISMATCH if the command failed because of meta-data restrictions
- DATA\_STORE\_FAILURE if an error occurred while accessing the data store
- COMMAND\_FAILED if some unspecified error is encountered while attempting to complete the command

*See Also* DmtSession.execute(String, String), DmtSession.execute(String, String, String)

**117.15.4 public interface MountPlugin**

This interface can be optionally implemented by a DataPlugin or ExecPlugin in order to get information about its absolute mount points in the overall DMT.

This is especially interesting, if the plugin is mapped to the tree as part of a list. In such a case the id for this particular data plugin is determined by the DmtAdmin after the registration of the plugin and therefore unknown to the plugin in advance.

This is not a service interface, the Data or Exec Plugin does not also have to register this interface as a service, the Dmt Admin should use an instance of to detect that a Plugin is also a Mount Plugin.

*Since* 2.0

**117.15.4.1 public void mountPointAdded(MountPoint mountPoint)**

*mountPoint* the newly mapped mount point

- Provides the MountPoint describing the path where the plugin is mapped in the overall DMT. The given mountPoint is withdrawn with the mountPointRemoved(MountPoint) method. Corresponding mount points must compare equal and have an appropriate hash code.

**117.15.4.2 public void mountPointRemoved(MountPoint mountPoint)**

*mountPoint* The unmapped mount point array of MountPoint objects that have been removed from the mapping

- Informs the plugin that the provided MountPoint objects have been removed from the mapping. The given mountPoint is withdrawn method. Mount points must compare equal and have an appropriate hash code with the given Mount Point in mountPointAdded(MountPoint).

NOTE: attempts to invoke the postEvent method on the provided MountPoint must be ignored.

**117.15.5 public interface MountPoint**

This interface can be implemented to represent a single mount point.

It provides function to get the absolute mounted uri and a shortcut method to post events via the DmtAdmin.

*Since* 2.0

**117.15.5.1 public boolean equals(Object other)**

- This object must provide a suitable hash function such that a Mount Point given in `MountPlugin.mountPointAdded(MountPoint)` is equal to the corresponding Mount Point in `MountPlugin.mountPointRemoved(MountPoint)`. `Object.equals(Object)`

**117.15.5.2 public String[] getMountPath()**

- Provides the absolute mount path of this MountPoint

*Returns* the absolute mount path of this MountPoint

**117.15.5.3 public int hashCode()**

- This object must provide a suitable hash function such that a Mount Point given in `MountPlugin.mountPointAdded(MountPoint)` has the same `hashCode` as the corresponding Mount Point in `MountPlugin.mountPointRemoved(MountPoint)`. `Object.hashCode()`

**117.15.5.4 public void postEvent(String topic,String[] relativeURIs,Dictionary properties)**

*topic* the topic of the event to send. Valid values are:

- `org.osgi/service/dmt/DmtEvent/ADDED` if the change was caused by an add action
- `org.osgi/service/dmt/DmtEvent/DELETED` if the change was caused by a delete action
- `org.osgi/service/dmt/DmtEvent/REPLACED` if the change was caused by a replace action

Must not be null.

*relativeURIs* an array of affected node URI's. All URI's specified here are relative to the current MountPoint's `mountPath`. The value of this parameter determines the value of the event property `EVENT_PROPERTY_NODES`. An empty array or null is permitted. In both cases the value of the events `EVENT_PROPERTY_NODES` property will be set to an empty array.

*properties* an optional parameter that can be provided to add properties to the Event that is going to be send by the DMTAdmin. If the properties contain a key `EVENT_PROPERTY_NODES`, then the value of this property is ignored and will be overwritten by `relativeURIs`.

- Posts an event via the DmtAdmin about changes in the current plugins subtree.

This method distributes Events asynchronously to the EventAdmin as well as to matching local `DmtEventListeners`.

*Throws* `IllegalArgumentException`– if the topic has not one of the defined values

**117.15.5.5 public void postEvent(String topic,String[] relativeURIs,String[] newRelativeURIs,Dictionary properties)**

*topic* the topic of the event to send. Valid values are:

- `org.osgi/service/dmt/DmtEvent/RENAMED` if the change was caused by a rename action
- `org.osgi/service/dmt/DmtEvent/COPIED` if the change was caused by a copy action

Must not be null.

*relativeURIs* an array of affected node URI's.

All URI's specified here are relative to the current MountPoint's mountPath. The value of this parameter determines the value of the event property `EVENT_PROPERTY_NODES`. An empty array or null is permitted. In both cases the value of the events `EVENT_PROPERTY_NODES` property will be set to an empty array.

*newRelativeURIs* an array of affected node URI's. The value of this parameter determines the value of the event property `EVENT_PROPERTY_NEW_NODES`. An empty array or null is permitted. In both cases the value of the events `EVENT_PROPERTY_NEW_NODES` property will be set to an empty array.

*properties* an optional parameter that can be provided to add properties to the Event that is going to be send by the DMTAdmin. If the properties contain the keys `EVENT_PROPERTY_NODES` or `EVENT_PROPERTY_NEW_NODES`, then the values of these properties are ignored and will be overwritten by relativeURIs and newRelativeURIs.

- Posts an event via the DmtAdmin about changes in the current plugins subtree.

This method distributes Events asynchronously to the EventAdmin as well as to matching local DmtEventListeners.

*Throws* `IllegalArgumentException`– if the topic has not one of the defined values

## 117.15.6 public interface ReadableDataSession

Provides read-only access to the part of the tree handled by the plugin that created this session.

Since the `ReadWriteDataSession` and `TransactionalDataSession` interfaces inherit from this interface, some of the method descriptions do not apply for an instance that is only a `ReadableDataSession`. For example, the `close()` method description also contains information about its behavior when invoked as part of a transactional session.

The `nodePath` parameters appearing in this interface always contain an array of path segments identifying a node in the subtree of this plugin. This parameter contains an absolute path, so the first segment is always `."`. Special characters appear escaped in the segments.

### Error handling

When a tree access command is called on the DmtAdmin service, it must perform an extensive set of checks on the parameters and the authority of the caller before delegating the call to a plugin. Therefore plugins can take certain circumstances for granted: that the path is valid and is within the subtree of the plugin and the session, the command can be applied to the given node (e.g. the target of `getChildNodeNames` is an interior node), etc. All errors described by the error codes `DmtException.INVALID_URI`, `DmtException.URI_TOO_LONG`, `DmtException.PERMISSION_DENIED`, `DmtException.COMMAND_NOT_ALLOWED` and `DmtException.TRANSACTION_ERROR` are fully filtered out before control reaches the plugin.

If the plugin provides meta-data for a node, the DmtAdmin service must also check the constraints specified by it, as described in `MetaNode`. If the plugin does not provide meta-data, it must perform the necessary checks for itself and use the `DmtException.METADATA_MISMATCH` error code to indicate such discrepancies.

The DmtAdmin does not check that the targeted node exists before calling the plugin. It is the responsibility of the plugin to perform this check and to throw a `DmtException.NODE_NOT_FOUND` if needed. In this case the DmtAdmin must pass through this exception to the caller of the corresponding `DmtSession` method.

The plugin can use the remaining error codes as needed. If an error does not fit into any other category, the `DmtException.COMMAND_FAILED` code should be used.

### 117.15.6.1 public void close() throws DmtException

- Closes a session. This method is always called when the session ends for any reason: if the session is closed, if a fatal error occurs in any method, or if any error occurs during commit or rollback. In case the session was invalidated due to an exception during commit or rollback, it is guaranteed that no

methods are called on the plugin until it is closed. In case the session was invalidated due to a fatal exception in one of the tree manipulation methods, only the rollback method is called before this (and only in atomic sessions).

This method should not perform any data manipulation, only cleanup operations. In non-atomic read-write sessions the data manipulation should be done instantly during each tree operation, while in atomic sessions the DmtAdmin always calls `TransactionalDataSession.commit()` automatically before the session is actually closed.

*Throws* `DmtException`– with the error code `COMMAND_FAILED` if the plugin failed to close for any reason

#### 117.15.6.2 **public String[] getChildNodeNames(String[] nodePath) throws DmtException**

*nodePath* the absolute path of the node

- Get the list of children names of a node. The returned array contains the names - not the URIs - of the immediate children nodes of the given node. The returned array may contain null entries, but these are removed by the DmtAdmin before returning it to the client.

*Returns* the list of child node names as a string array or an empty string array if the node has no children

*Throws* `DmtException`– with the following possible error codes:

- `NODE_NOT_FOUND` if `nodePath` points to a non-existing node
- `METADATA_MISMATCH` if the information could not be retrieved because of meta-data restrictions
- `DATA_STORE_FAILURE` if an error occurred while accessing the data store
- `COMMAND_FAILED` if some unspecified error is encountered while attempting to complete the command

`SecurityException`– if the caller does not have the necessary permissions to execute the underlying management operation

#### 117.15.6.3 **public MetaNode getMetaNode(String[] nodePath) throws DmtException**

*nodePath* the absolute path of the node

- Get the meta data which describes a given node. Meta data can be only inspected, it can not be changed.

Meta data support by plugins is an optional feature. It can be used, for example, when a data plugin is implemented on top of a data store or another API that has their own metadata, such as a relational database, in order to avoid metadata duplication and inconsistency. The meta data specific to the plugin returned by this method is complemented by meta data from the DmtAdmin before returning it to the client. If there are differences in the meta data elements known by the plugin and the DmtAdmin then the plugin specific elements take precedence.

Note, that a node does not have to exist for having meta-data associated with it. This method may provide meta-data for any node that can possibly exist in the tree (any node defined by the Management Object provided by the plugin). For nodes that are not defined, a `DmtException` may be thrown with the `NODE_NOT_FOUND` error code. To allow easier implementation of plugins that do not provide meta-data, it is allowed to return null for any node, regardless of whether it is defined or not.

*Returns* a `MetaNode` which describes meta data information, can be null if there is no meta data available for the given node

*Throws* `DmtException`– with the following possible error codes:

- `NODE_NOT_FOUND` if `nodeUri` points to a node that is not defined in the tree (see above)
- `DATA_STORE_FAILURE` if an error occurred while accessing the data store
- `COMMAND_FAILED` if some unspecified error is encountered while attempting to complete the command

SecurityException– if the caller does not have the necessary permissions to execute the underlying management operation

#### 117.15.6.4 **public int getNodeSize(String[] nodePath) throws DmtException**

*nodePath* the absolute path of the leaf node

- Get the size of the data in a leaf node. The value to return depends on the format of the data in the node, see the description of the `DmtData.getSize()` method for the definition of node size for each format.

*Returns* the size of the data in the node

*Throws* DmtException– with the following possible error codes:

- `NODE_NOT_FOUND` if `nodePath` points to a non-existing node
- `METADATA_MISMATCH` if the information could not be retrieved because of meta-data restrictions
- `FEATURE_NOT_SUPPORTED` if the Size property is not supported by the plugin
- `DATA_STORE_FAILURE` if an error occurred while accessing the data store
- `COMMAND_FAILED` if some unspecified error is encountered while attempting to complete the command

SecurityException– if the caller does not have the necessary permissions to execute the underlying management operation

*See Also* `DmtData.getSize()`

#### 117.15.6.5 **public Date getNodeTimestamp(String[] nodePath) throws DmtException**

*nodePath* the absolute path of the node

- Get the timestamp when the node was last modified.

*Returns* the timestamp of the last modification

*Throws* DmtException– with the following possible error codes:

- `NODE_NOT_FOUND` if `nodePath` points to a non-existing node
- `METADATA_MISMATCH` if the information could not be retrieved because of meta-data restrictions
- `FEATURE_NOT_SUPPORTED` if the Timestamp property is not supported by the plugin
- `DATA_STORE_FAILURE` if an error occurred while accessing the data store
- `COMMAND_FAILED` if some unspecified error is encountered while attempting to complete the command

SecurityException– if the caller does not have the necessary permissions to execute the underlying management operation

#### 117.15.6.6 **public String getNodeTitle(String[] nodePath) throws DmtException**

*nodePath* the absolute path of the node

- Get the title of a node. There might be no title property set for a node.

*Returns* the title of the node, or null if the node has no title

*Throws* DmtException– with the following possible error codes:

- `NODE_NOT_FOUND` if `nodePath` points to a non-existing node
- `METADATA_MISMATCH` if the information could not be retrieved because of meta-data restrictions
- `FEATURE_NOT_SUPPORTED` if the Title property is not supported by the plugin

- DATA\_STORE\_FAILURE if an error occurred while accessing the data store
- COMMAND\_FAILED if some unspecified error is encountered while attempting to complete the command

SecurityException– if the caller does not have the necessary permissions to execute the underlying management operation

#### 117.15.6.7 **public String getNodeType(String[] nodePath) throws DmtException**

*nodePath* the absolute path of the node

- Get the type of a node. The type of leaf node is the MIME type of the data it contains. The type of an interior node is a URI identifying a DDF document; a null type means that there is no DDF document overriding the tree structure defined by the ancestors.

*Returns* the type of the node, can be null

*Throws* DmtException– with the following possible error codes:

- NODE\_NOT\_FOUND if *nodePath* points to a non-existing node
- METADATA\_MISMATCH if the information could not be retrieved because of meta-data restrictions
- DATA\_STORE\_FAILURE if an error occurred while accessing the data store
- COMMAND\_FAILED if some unspecified error is encountered while attempting to complete the command

SecurityException– if the caller does not have the necessary permissions to execute the underlying management operation

#### 117.15.6.8 **public DmtData getNodeValue(String[] nodePath) throws DmtException**

*nodePath* the absolute path of the node to retrieve

- Get the data contained in a leaf or interior node.

*Returns* the data of the leaf node, must not be null

*Throws* DmtException– with the following possible error codes:

- NODE\_NOT\_FOUND if *nodePath* points to a non-existing node
- METADATA\_MISMATCH if the information could not be retrieved because of meta-data restrictions
- FEATURE\_NOT\_SUPPORTED if the specified node is an interior node and does not support Java object values
- DATA\_STORE\_FAILURE if an error occurred while accessing the data store
- COMMAND\_FAILED if some unspecified error is encountered while attempting to complete the command

SecurityException– if the caller does not have the necessary permissions to execute the underlying management operation

#### 117.15.6.9 **public int getNodeVersion(String[] nodePath) throws DmtException**

*nodePath* the absolute path of the node

- Get the version of a node. The version can not be set, it is calculated automatically by the device. It is incremented modulo 0x10000 at every modification of the value or any other property of the node, for both leaf and interior nodes. When a node is created the initial value is 0.

*Returns* the version of the node

*Throws* DmtException– with the following possible error codes:

- `NODE_NOT_FOUND` if `nodePath` points to a non-existing node
- `METADATA_MISMATCH` if the information could not be retrieved because of meta-data restrictions
- `FEATURE_NOT_SUPPORTED` if the Version property is not supported by the plugin
- `DATA_STORE_FAILURE` if an error occurred while accessing the data store
- `COMMAND_FAILED` if some unspecified error is encountered while attempting to complete the command

`SecurityException`– if the caller does not have the necessary permissions to execute the underlying management operation

#### 117.15.6.10 **public boolean isLeafNode(String[] nodePath) throws DmtException**

*nodePath* the absolute path of the node

- Tells whether a node is a leaf or an interior node of the DMT.

*Returns* true if the given node is a leaf node

*Throws* `DmtException`– with the following possible error codes:

- `NODE_NOT_FOUND` if `nodePath` points to a non-existing node
- `METADATA_MISMATCH` if the information could not be retrieved because of meta-data restrictions
- `DATA_STORE_FAILURE` if an error occurred while accessing the data store
- `COMMAND_FAILED` if some unspecified error is encountered while attempting to complete the command

`SecurityException`– if the caller does not have the necessary permissions to execute the underlying management operation

#### 117.15.6.11 **public boolean isNodeUri(String[] nodePath)**

*nodePath* the absolute path to check

- Check whether the specified path corresponds to a valid node in the DMT.

*Returns* true if the given node exists in the DMT

#### 117.15.6.12 **public void nodeChanged(String[] nodePath) throws DmtException**

*nodePath* the absolute path of the node that has changed

- Notifies the plugin that the given node has changed outside the scope of the plugin, therefore the Version and Timestamp properties must be updated (if supported). This method is needed because the ACL property of a node is managed by the `DmtAdmin` instead of the plugin. The `DmtAdmin` must call this method whenever the ACL property of a node changes.

*Throws* `DmtException`– with the following possible error codes:

- `NODE_NOT_FOUND` if `nodePath` points to a non-existing node
- `DATA_STORE_FAILURE` if an error occurred while accessing the data store
- `COMMAND_FAILED` if some unspecified error is encountered while attempting to complete the command

### 117.15.7 **public interface ReadWriteDataSession extends ReadableDataSession**

Provides non-atomic read-write access to the part of the tree handled by the plugin that created this session.



The `nodePath` parameters appearing in this interface always contain an array of path segments identifying a node in the subtree of this plugin. This parameter contains an absolute path, so the first segment is always ".". Special characters appear escaped in the segments.

### Error handling

When a tree manipulation command is called on the `DmtAdmin` service, it must perform an extensive set of checks on the parameters and the authority of the caller before delegating the call to a plugin. Therefore plugins can take certain circumstances for granted: that the path is valid and is within the subtree of the plugin and the session, the command can be applied to the given node (e.g. the target of `setNodeValue` is a leaf node), etc. All errors described by the error codes `DmtException.INVALID_URI`, `DmtException.URI_TOO_LONG`, `DmtException.PERMISSION_DENIED`, `DmtException.COMMAND_NOT_ALLOWED` and `DmtException.TRANSACTION_ERROR` are fully filtered out before control reaches the plugin.

If the plugin provides meta-data for a node, the `DmtAdmin` service must also check the constraints specified by it, as described in `MetaNode`. If the plugin does not provide meta-data, it must perform the necessary checks for itself and use the `DmtException.METADATA_MISMATCH` error code to indicate such discrepancies.

The `DmtAdmin` does not check that the targeted node exists (or that it does not exist, in case of a node creation) before calling the plugin. It is the responsibility of the plugin to perform this check and to throw a `DmtException.NODE_NOT_FOUND` or `DmtException.NODE_ALREADY_EXISTS` if needed. In this case the `DmtAdmin` must pass through this exception to the caller of the corresponding `DmtSession` method.

The plugin can use the remaining error codes as needed. If an error does not fit into any other category, the `DmtException.COMMAND_FAILED` code should be used.

#### 117-15.7.1 **public void copy(String[] nodePath,String[] newNodePath,boolean recursive) throws DmtException**

*nodePath* an absolute path specifying the node or the root of a subtree to be copied

*newNodePath* the absolute path of the new node or root of a subtree

*recursive* false if only a single node is copied, true if the whole subtree is copied

- Create a copy of a node or a whole subtree. Beside the structure and values of the nodes, most properties managed by the plugin must also be copied, with the exception of the `Timestamp` and `Version` properties.

*Throws* `DmtException`– with the following possible error codes:

- `NODE_NOT_FOUND` if `nodePath` points to a non-existing node, or if `newNodePath` points to a node that cannot exist in the tree
- `NODE_ALREADY_EXISTS` if `newNodePath` points to a node that already exists
- `METADATA_MISMATCH` if the node could not be copied because of meta-data restrictions
- `FEATURE_NOT_SUPPORTED` if the copy operation is not supported by the plugin
- `DATA_STORE_FAILURE` if an error occurred while accessing the data store
- `COMMAND_FAILED` if some unspecified error is encountered while attempting to complete the command

`SecurityException`– if the caller does not have the necessary permissions to execute the underlying management operation

*See Also* `DmtSession.copy(String, String, boolean)`

#### 117-15.7.2 **public void createInteriorNode(String[] nodePath,String type) throws DmtException**

*nodePath* the absolute path of the node to create

*type* the type URI of the interior node, can be null if no node type is defined

- Create an interior node with a given type. The type of interior node, if specified, is a URI identifying a DDF document.

*Throws* DmtException– with the following possible error codes:

- NODE\_NOT\_FOUND if *nodePath* points to a node that cannot exist in the tree
- NODE\_ALREADY\_EXISTS if *nodeUri* points to a node that already exists
- METADATA\_MISMATCH if the node could not be created because of meta-data restrictions
- DATA\_STORE\_FAILURE if an error occurred while accessing the data store
- COMMAND\_FAILED if some unspecified error is encountered while attempting to complete the command

SecurityException– if the caller does not have the necessary permissions to execute the underlying management operation

*See Also* DmtSession.createInteriorNode(String), DmtSession.createInteriorNode(String, String)

### 117.15.7.3 **public void createLeafNode(String[] nodePath, DmtData value, String mimeType) throws DmtException**

*nodePath* the absolute path of the node to create

*value* the value to be given to the new node, can be null

*mimeType* the MIME type to be given to the new node, can be null

- Create a leaf node with a given value and MIME type. If the specified value or MIME type is null, their default values must be taken.

*Throws* DmtException– with the following possible error codes:

- NODE\_NOT\_FOUND if *nodePath* points to a node that cannot exist in the tree
- NODE\_ALREADY\_EXISTS if *nodePath* points to a node that already exists
- METADATA\_MISMATCH if the node could not be created because of meta-data restrictions
- DATA\_STORE\_FAILURE if an error occurred while accessing the data store
- COMMAND\_FAILED if some unspecified error is encountered while attempting to complete the command

SecurityException– if the caller does not have the necessary permissions to execute the underlying management operation

*See Also* DmtSession.createLeafNode(String), DmtSession.createLeafNode(String, DmtData), DmtSession.createLeafNode(String, DmtData, String)

### 117.15.7.4 **public void deleteNode(String[] nodePath) throws DmtException**

*nodePath* the absolute path of the node to delete

- Delete the given node. Deleting interior nodes is recursive, the whole subtree under the given node is deleted.

*Throws* DmtException– with the following possible error codes:

- NODE\_NOT\_FOUND if *nodePath* points to a non-existing node
- METADATA\_MISMATCH if the node could not be deleted because of meta-data restrictions
- DATA\_STORE\_FAILURE if an error occurred while accessing the data store
- COMMAND\_FAILED if some unspecified error is encountered while attempting to complete the command

SecurityException– if the caller does not have the necessary permissions to execute the underlying management operation

*See Also* DmtSession.deleteNode(String)

**117-15-7.5 public void renameNode(String[] nodePath,String newName) throws DmtException**

*nodePath* the absolute path of the node to rename

*newName* the new name property of the node

- Rename a node. This operation only changes the name of the node (updating the timestamp and version properties if they are supported), the value and the other properties are not changed. The new name of the node must be provided, the new path is constructed from the base of the old path and the given name.

*Throws* DmtException– with the following possible error codes:

- NODE\_NOT\_FOUND if *nodePath* points to a non-existing node, or if the new node is not defined in the tree
- NODE\_ALREADY\_EXISTS if there already exists a sibling of *nodePath* with the name *newName*
- METADATA\_MISMATCH if the node could not be renamed because of meta-data restrictions
- DATA\_STORE\_FAILURE if an error occurred while accessing the data store
- COMMAND\_FAILED if some unspecified error is encountered while attempting to complete the command

SecurityException– if the caller does not have the necessary permissions to execute the underlying management operation

*See Also* DmtSession.renameNode(String, String)

**117-15-7.6 public void setNodeTitle(String[] nodePath,String title) throws DmtException**

*nodePath* the absolute path of the node

*title* the title text of the node, can be null

- Set the title property of a node. The length of the title is guaranteed not to exceed the limit of 255 bytes in UTF-8 encoding.

*Throws* DmtException– with the following possible error codes:

- NODE\_NOT\_FOUND if *nodePath* points to a non-existing node
- METADATA\_MISMATCH if the title could not be set because of meta-data restrictions
- FEATURE\_NOT\_SUPPORTED if the Title property is not supported by the plugin
- DATA\_STORE\_FAILURE if an error occurred while accessing the data store
- COMMAND\_FAILED if some unspecified error is encountered while attempting to complete the command

SecurityException– if the caller does not have the necessary permissions to execute the underlying management operation

*See Also* DmtSession.setNodeTitle(String, String)

**117-15-7.7 public void setNodeType(String[] nodePath,String type) throws DmtException**

*nodePath* the absolute path of the node

*type* the type of the node, can be null

- Set the type of a node. The type of leaf node is the MIME type of the data it contains. The type of an interior node is a URI identifying a DDF document.

For interior nodes, the null type should remove the reference (if any) to a DDF document overriding the tree structure defined by the ancestors. For leaf nodes, it requests that the default MIME type is used for the given node.

*Throws* DmtException– with the following possible error codes:

- `NODE_NOT_FOUND` if `nodePath` points to a non-existing node
- `METADATA_MISMATCH` if the type could not be set because of meta-data restrictions
- `DATA_STORE_FAILURE` if an error occurred while accessing the data store
- `COMMAND_FAILED` if some unspecified error is encountered while attempting to complete the command

`SecurityException`– if the caller does not have the necessary permissions to execute the underlying management operation

*See Also* `DmtSession.setNodeType(String, String)`

### 117.15.7.8 **public void setNodeValue(String[] nodePath, DmtData data) throws DmtException**

*nodePath* the absolute path of the node

*data* the data to be set, can be null

- Set the value of a leaf or interior node. The format of the node is contained in the `DmtData` object. For interior nodes, the format is `FORMAT_NODE`, while for leaf nodes this format is never used.

If the specified value is null, the default value must be taken; if there is no default value, a `DmtException` with error code `METADATA_MISMATCH` must be thrown.

*Throws* `DmtException`– with the following possible error codes:

- `NODE_NOT_FOUND` if `nodePath` points to a non-existing node
- `METADATA_MISMATCH` if the value could not be set because of meta-data restrictions
- `FEATURE_NOT_SUPPORTED` if the specified node is an interior node and does not support Java object values
- `DATA_STORE_FAILURE` if an error occurred while accessing the data store
- `COMMAND_FAILED` if some unspecified error is encountered while attempting to complete the command

`SecurityException`– if the caller does not have the necessary permissions to execute the underlying management operation

*See Also* `DmtSession.setNodeValue(String, DmtData)`

## 117.15.8 **public interface TransactionalDataSession extends ReadWriteDataSession**

Provides atomic read-write access to the part of the tree handled by the plugin that created this session.

### 117.15.8.1 **public void commit() throws DmtException**

- Commits a series of DMT operations issued in the current atomic session since the last transaction boundary. Transaction boundaries are the creation of this object that starts the session, and all subsequent `commit()` and `rollback()` calls.

This method can fail even if all operations were successful. This can happen due to some multi-node semantic constraints defined by a specific implementation. For example, node A can be required to always have children A/B, A/C and A/D. If this condition is broken when `commit()` is executed, the method will fail, and throw a `METADATA_MISMATCH` exception.

In many cases the tree is not the only way to manage a given part of the system. It may happen that while modifying some nodes in an atomic session, the underlying settings are modified in parallel outside the scope of the DMT. If this is detected during commit, an exception with the code `CONCURRENT_ACCESS` is thrown.

*Throws* `DmtException`– with the following possible error codes

- METADATA\_MISMATCH if the operation failed because of meta-data restrictions
- CONCURRENT\_ACCESS if it is detected that some modification has been made outside the scope of the DMT to the nodes affected in the session's operations
- DATA\_STORE\_FAILURE if an error occurred while accessing the data store
- COMMAND\_FAILED if some unspecified error is encountered while attempting to complete the command

SecurityException– if the caller does not have the necessary permissions to execute the underlying management operation

#### 117.15.8.2 **public void rollback() throws DmtException**

- Rolls back a series of DMT operations issued in the current atomic session since the last transaction boundary. Transaction boundaries are the creation of this object that starts the session, and all subsequent commit and rollback calls.

*Throws* DmtException– with the error code ROLLBACK\_FAILED in case the rollback did not succeed

SecurityException– if the caller does not have the necessary permissions to execute the underlying management operation

## 117.16 **org.osgi.service.dmt.notification**

Device Management Tree Notification Package Version 2.0.

This package contains the public API of the Notification service. This service enables the sending of asynchronous notifications to management servers. Permission classes are provided by the org.osgi.service.dmt.security package.

Bundles wishing to use this package must list the package in the Import-Package header of the bundle's manifest. This package has two types of users: the consumers that use the API in this package and the providers that implement the API in this package.

Example import for consumers using the API in this package:

```
Import-Package: org.osgi.service.dmt.notification; version="[2.0,3.0)"
```

Example import for providers implementing the API in this package:

```
Import-Package: org.osgi.service.dmt.notification; version="[2.0,2.1)"
```

### 117.16.1 **Summary**

- AlertItem - Immutable data structure carried in an alert (client initiated notification).
- NotificationService - NotificationService enables sending asynchronous notifications to a management server.

### 117.16.2 **public class AlertItem**

Immutable data structure carried in an alert (client initiated notification). The AlertItem describes details of various notifications that can be sent by the client, for example as alerts in the OMA DM protocol. The use cases include the client sending a session request to the server (alert 1201), the client notifying the server of completion of a software update operation (alert 1226) or sending back results in response to an asynchronous EXEC command.

The data syntax and semantics varies widely between various alerts, so does the optionality of particular parameters of an alert item. If an item, such as source or type, is not defined, the corresponding getter method returns null. For example, for alert 1201 (client-initiated session) all elements will be null.

The syntax used in `AlertItem` class corresponds to the OMA DM alert format. `NotificationService` implementations on other management protocols should map these constructs to the underlying protocol.

#### 117.16.2.1 **public AlertItem(String source,String type,String mark,DmtData data)**

*source* the URI of the node which is the source of the alert item

*type* a MIME type or a URN that identifies the type of the data in the alert item

*data* a `DmtData` object that contains the format and value of the data in the alert item

*mark* the mark parameter of the alert item

- Create an instance of the alert item. The constructor takes all possible data entries as parameters. Any of these parameters can be null. The semantics of the parameters may be refined by the definition of a specific alert, identified by its alert code (see `NotificationService.sendNotification(String, int, String, AlertItem[])`). In case of Generic Alerts for example (code 1226), the mark parameter contains a severity string.

#### 117.16.2.2 **public AlertItem(String[] source,String type,String mark,DmtData data)**

*source* the path of the node which is the source of the alert item

*type* a MIME type or a URN that identifies the type of the data in the alert item

*data* a `DmtData` object that contains the format and value of the data in the alert item

*mark* the mark parameter of the alert item

- Create an instance of the alert item, specifying the source node URI as an array of path segments. The constructor takes all possible data entries as parameters. Any of these parameters can be null. The semantics of the parameters may be refined by the definition of a specific alert, identified by its alert code (see `NotificationService.sendNotification(String, int, String, AlertItem[])`). In case of Generic Alerts for example (code 1226), the mark parameter contains a severity string.

#### 117.16.2.3 **public DmtData getData()**

- Get the data associated with the alert item. The returned `DmtData` object contains the format and the value of the data in the alert item. There might be no data associated with the alert item.

*Returns* the data associated with the alert item, or null if there is no data

#### 117.16.2.4 **public String getMark()**

- Get the mark parameter associated with the alert item. The interpretation of the mark parameter depends on the alert being sent, as identified by the alert code in `NotificationService.sendNotification(String, int, String, AlertItem[])`. There might be no mark associated with the alert item.

*Returns* the mark associated with the alert item, or null if there is no mark

#### 117.16.2.5 **public String getSource()**

- Get the node which is the source of the alert. There might be no source associated with the alert item.

*Returns* the URI of the node which is the source of this alert, or null if there is no source

#### 117.16.2.6 **public String getType()**

- Get the type associated with the alert item. The type string is a MIME type or a URN that identifies the type of the data in the alert item (returned by `getData()`). There might be no type associated with the alert item.

*Returns* the type associated with the alert item, or null if there is no type

**117.16.2.7 public String toString()**

- Returns the string representation of this alert item. The returned string includes all parameters of the alert item, and has the following format:

```
AlertItem(<source>, <type>, <mark>, <data>)
```

The last parameter is the string representation of the data value. The format of the data is not explicitly included.

*Returns* the string representation of this alert item

**117.16.3 public interface NotificationService**

NotificationService enables sending asynchronous notifications to a management server. The implementation of NotificationService should register itself in the OSGi service registry as a service.

**117.16.3.1 public void sendNotification(String principal,int code,String correlator,AlertItem[] items) throws DmtException**

*principal* the principal name which is the recipient of this notification, can be null

*code* the alert code, can be 0 if not needed

*correlator* optional field that contains the correlation identifier of an associated exec command, can be null if not needed

*items* the data of the alert items carried in this alert, can be null or empty if not needed

- Sends a notification to a named principal. It is the responsibility of the NotificationService to route the notification to the given principal using the registered org.osgi.service.dmt.notification.spi.RemoteAlertSender services.

In remotely initiated sessions the principal name identifies the remote server that created the session, this can be obtained using the session's getPrincipal call.

The principal name may be omitted if the client does not know the principal name. Even in this case the routing might be possible if the Notification Service finds an appropriate default destination (for example if it is only connected to one protocol adapter, which is only connected to one management server).

Since sending the notification and receiving acknowledgment for it is potentially a very time-consuming operation, notifications are sent asynchronously. This method should attempt to ensure that the notification can be sent successfully, and should throw an exception if it detects any problems. If the method returns without error, the notification is accepted for sending and the implementation must make a best-effort attempt to deliver it.

In case the notification is an asynchronous response to a previous execute command, a correlation identifier can be specified to provide the association between the execute and the notification.

In order to send a notification using this method, the caller must have an AlertPermission with a target string matching the specified principal name. If the principal parameter is null (the principal name is not known), the target of the AlertPermission must be "\*".

When this method is called with null correlator, null or empty AlertItem array, and a 0 code as values, it should send a protocol specific default notification to initiate a management session. For example, in case of OMA DM this is alert 1201 "Client Initiated Session". The principal parameter can be used to determine the recipient of the session initiation request.

*Throws* DmtException– with the following possible error codes:

- UNAUTHORIZED when the remote server rejected the request due to insufficient authorization
- ALERT\_NOT\_ROUTED when the alert can not be routed to the given principal
- REMOTE\_ERROR in case of communication problems between the device and the destination

- `COMMAND_FAILED` for unspecified errors encountered while attempting to complete the command
- `FEATURE_NOT_SUPPORTED` if the underlying management protocol doesn't support asynchronous notifications

`SecurityException`—if the caller does not have the required `AlertPermission` with a target matching the principal parameter, as described above

## 117.17 org.osgi.service.dmt.notification.spi

Device Management Tree Notification SPI Package Version 2.0.

This package contains the SPI (Service Provider Interface) of the Notification service. These interfaces are implemented by Protocol Adapters capable of delivering notifications to management servers on a specific protocol. Users of the `NotificationService` interface do not interact directly with this package.

Bundles wishing to use this package must list the package in the `Import-Package` header of the bundle's manifest. This package has two types of users: the consumers that use the API in this package and the providers that implement the API in this package.

Example import for consumers using the API in this package:

```
Import-Package: org.osgi.service.dmt.notification.spi; version="[2.0,3.0)"
```

Example import for providers implementing the API in this package:

```
Import-Package: org.osgi.service.dmt.notification.spi; version="[2.0,2.1)"
```

### 117.17.1 Summary

- `RemoteAlertSender` - The `RemoteAlertSender` can be used to send notifications to (remote) entities identified by principal names.

### 117.17.2 public interface `RemoteAlertSender`

The `RemoteAlertSender` can be used to send notifications to (remote) entities identified by principal names. This service is provided by Protocol Adapters, and is used by the `org.osgi.service.dmt.notification.NotificationService` when sending alerts. Implementations of this interface have to be able to connect and send alerts to one or more management servers in a protocol specific way.

The properties of the service registration should specify a list of destinations (principals) where the service is capable of sending alerts. This can be done by providing a `String` array of principal names in the `principals` registration property. If this property is not registered, the service will be treated as the default sender. The default alert sender is only used when a more specific alert sender cannot be found.

The `principals` registration property is used when the `org.osgi.service.dmt.notification.NotificationService.sendNotification(String, int, String, AlertItem[])` method is called, to find the proper `RemoteAlertSender` for the given destination. If the caller does not specify a principal, the alert is only sent if the `NotificationSender` finds a default alert sender, or if the choice is unambiguous for some other reason (for example if only one alert sender is registered).

#### 117.17.2.1 **public void sendAlert(String principal,int code,String correlator,AlertItem[] items) throws Exception**

*principal* the name identifying the server where the alert should be sent, can be null

*code* the alert code, can be 0 if not needed



- correlator* the correlation identifier of an associated EXEC command, or null if there is no associated EXEC
- items* the data of the alert items carried in this alert, can be empty or null if no alert items are needed
- Sends an alert to a server identified by its principal name. In case the alert is sent in response to a previous execute command, a correlation identifier can be specified to provide the association between the execute and the alert.

The principal parameter specifies which server the alert should be sent to. This parameter can be null if the client does not know the name of the destination. The alert should still be delivered if possible; for example if the alert sender is only connected to one destination.

Any exception thrown on this method will be propagated to the original sender of the event, wrapped in a `DmtException` with the code `REMOTE_ERROR`.

Since sending the alert and receiving acknowledgment for it is potentially a very time-consuming operation, alerts are sent asynchronously. This method should attempt to ensure that the alert can be sent successfully, and should throw an exception if it detects any problems. If the method returns without error, the alert is accepted for sending and the implementation must make a best-effort attempt to deliver it.

*Throws* Exception— if the alert can not be sent to the server

## 117.18 org.osgi.service.dmt.security

Device Management Tree Security Package Version 2.0.

This package contains the permission classes used by the Device Management API in environments that support the Java 2 security model.

Bundles wishing to use this package must list the package in the Import-Package header of the bundle's manifest. This package has two types of users: the consumers that use the API in this package and the providers that implement the API in this package.

Example import for consumers using the API in this package:

```
Import-Package: org.osgi.service.dmt.security; version="[2.0,3.0]"
```

Example import for providers implementing the API in this package:

```
Import-Package: org.osgi.service.dmt.security; version="[2.0,2.1]"
```

### 117.18.1 Summary

- `AlertPermission` - Indicates the callers authority to send alerts to management servers, identified by their principal names.
- `DmtPermission` - Controls access to management objects in the Device Management Tree (DMT).
- `DmtPrincipalPermission` - Indicates the callers authority to create DMT sessions on behalf of a remote management server.

### 117.18.2 public class `AlertPermission` extends `Permission`

Indicates the callers authority to send alerts to management servers, identified by their principal names.

`AlertPermission` has a target string which controls the principal names where alerts can be sent. A wildcard is allowed at the end of the target string, to allow sending alerts to any principal with a name matching the given prefix. The "\*" target means that alerts can be sent to any destination.

**117.18.2.1 public AlertPermission(String target)**

*target* the name of a principal, can end with \* to match any principal identifier with the given prefix

- Creates a new AlertPermission object with its name set to the target string. Name must be non-null and non-empty.

*Throws* NullPointerException– if name is null

IllegalArgumentException– if name is empty

**117.18.2.2 public AlertPermission(String target,String actions)**

*target* the name of the server, can end with \* to match any server identifier with the given prefix

*actions* no actions defined, must be "\*" for forward compatibility

- Creates a new AlertPermission object using the 'canonical' two argument constructor. In this version this class does not define any actions, the second argument of this constructor must be "\*" so that this class can later be extended in a backward compatible way.

*Throws* NullPointerException– if name or actions is null

IllegalArgumentException– if name is empty or actions is not "\*"

**117.18.2.3 public boolean equals(Object obj)**

*obj* the object to compare to this AlertPermission instance

- Checks whether the given object is equal to this AlertPermission instance. Two AlertPermission instances are equal if they have the same target string.

*Returns* true if the parameter represents the same permissions as this instance

**117.18.2.4 public String getActions()**

- Returns the action list (always \* in the current version).

*Returns* the action string "\*"

**117.18.2.5 public int hashCode()**

- Returns the hash code for this permission object. If two AlertPermission objects are equal according to the equals(Object) method, then calling this method on each of the two AlertPermission objects must produce the same integer result.

*Returns* hash code for this permission object

**117.18.2.6 public boolean implies(Permission p)**

*p* the permission to check for implication

- Checks if this AlertPermission object implies the specified permission. Another AlertPermission instance is implied by this permission either if the target strings are identical, or if this target can be made identical to the other target by replacing a trailing "\*" with any string.

*Returns* true if this AlertPermission instance implies the specified permission

**117.18.2.7 public PermissionCollection newPermissionCollection()**

- Returns a new PermissionCollection object for storing AlertPermission objects.

*Returns* the new PermissionCollection

**117.18.3 public class DmtPermission extends Permission**

Controls access to management objects in the Device Management Tree (DMT). It is intended to control local access to the DMT. DmtPermission target string identifies the management object URI

and the action field lists the OMA DM commands that are permitted on the management object. Example:

```
DmtPermission("./OSGi/bundles", "Add,Replace,Get");
```

This means that owner of this permission can execute Add, Replace and Get commands on the ./OSGi/bundles management object. It is possible to use wildcards in both the target and the actions field. Wildcard in the target field means that the owner of the permission can access children nodes of the target node. Example:

```
DmtPermission("./OSGi/bundles/*", "Get");
```

This means that owner of this permission has Get access on every child node of ./OSGi/bundles. The asterisk does not necessarily have to follow a '/' character. For example the ./OSGi/a\* target matches the ./OSGi/applications subtree.

If wildcard is present in the actions field, all legal OMA DM commands are allowed on the designated nodes(s) by the owner of the permission. Action names are interpreted case-insensitively, but the canonical action string returned by getActions() uses the forms defined by the action constants.

#### 117.18.3.1 **public static final String ADD = "Add"**

Holders of DmtPermission with the Add action present can create new nodes in the DMT, that is they are authorized to execute the createInteriorNode() and createLeafNode() methods of the DmtSession. This action is also required for the copy() command, which needs to perform node creation operations (among others).

#### 117.18.3.2 **public static final String DELETE = "Delete"**

Holders of DmtPermission with the Delete action present can delete nodes from the DMT, that is they are authorized to execute the deleteNode() method of the DmtSession.

#### 117.18.3.3 **public static final String EXEC = "Exec"**

Holders of DmtPermission with the Exec action present can execute nodes in the DMT, that is they are authorized to call the execute() method of the DmtSession.

#### 117.18.3.4 **public static final String GET = "Get"**

Holders of DmtPermission with the Get action present can query DMT node value or properties, that is they are authorized to execute the isLeafNode(), getNodeAcl(), getEffectiveNodeAcl(), getMetaNode(), getNodeValue(), getChildNodeNames(), getNodeTitle(), getNodeVersion(), getNodeTimeStamp(), getNodeSize() and getNodeType() methods of the DmtSession. This action is also required for the copy() command, which needs to perform node query operations (among others).

#### 117.18.3.5 **public static final String REPLACE = "Replace"**

Holders of DmtPermission with the Replace action present can update DMT node value or properties, that is they are authorized to execute the setNodeAcl(), setNodeTitle(), setNodeValue(), setNodeType() and renameNode() methods of the DmtSession. This action is also be required for the copy() command if the original node had a title property (which must be set in the new node).

#### 117.18.3.6 **public DmtPermission(String dmtUri, String actions)**

*dmtUri* URI of the management object (or subtree)

*actions* OMA DM actions allowed

- Creates a new DmtPermission object for the specified DMT URI with the specified actions. The given URI can be:
  - "\*", which matches all valid (see Uri.isValidUri(String)) absolute URIs;

- the prefix of an absolute URI followed by the \* character (for example ".OSGi/L\*"), which matches all valid absolute URIs beginning with the given prefix;
- a valid absolute URI, which matches itself.

Since the \* character is itself a valid URI character, it can appear as the last character of a valid absolute URI. To distinguish this case from using \* as a wildcard, the \* character at the end of the URI must be escaped with the \ character. For example the URI ".a\*" matches ".a", ".aa", ".a/b" etc. while ".a\\*" matches ".a\*" only.

The actions string must either be "\*" to allow all actions, or it must contain a non-empty subset of the valid actions, defined as constants in this class.

*Throws* NullPointerException– if any of the parameters are null

IllegalArgumentException– if any of the parameters are invalid

### 117.18.3.7 **public boolean equals(Object obj)**

*obj* the object to compare to this DmtPermission instance

- Checks whether the given object is equal to this DmtPermission instance. Two DmtPermission instances are equal if they have the same target string and the same action mask. The "\*" action mask is considered equal to a mask containing all actions.

*Returns* true if the parameter represents the same permissions as this instance

### 117.18.3.8 **public String getActions()**

- Returns the String representation of the action list. The allowed actions are listed in the following order: Add, Delete, Exec, Get, Replace. The wildcard character is not used in the returned string, even if the class was created using the "\*" wildcard.

*Returns* canonical action list for this permission object

### 117.18.3.9 **public int hashCode()**

- Returns the hash code for this permission object. If two DmtPermission objects are equal according to the equals(Object) method, then calling this method on each of the two DmtPermission objects must produce the same integer result.

*Returns* hash code for this permission object

### 117.18.3.10 **public boolean implies(Permission p)**

*p* the permission to check for implication

- Checks if this DmtPermission object "implies" the specified permission. This method returns false if and only if at least one of the following conditions are fulfilled for the specified permission:
  - it is not a DmtPermission
  - its set of actions contains an action not allowed by this permission
  - the set of nodes defined by its path contains a node not defined by the path of this permission

*Returns* true if this DmtPermission instance implies the specified permission

### 117.18.3.11 **public PermissionCollection newPermissionCollection()**

- Returns a new PermissionCollection object for storing DmtPermission objects.

*Returns* the new PermissionCollection

## 117.18.4 **public class DmtPrincipalPermission extends Permission**

Indicates the callers authority to create DMT sessions on behalf of a remote management server. Only protocol adapters communicating with management servers should be granted this permission.

DmtPrincipalPermission has a target string which controls the name of the principal on whose behalf the protocol adapter can act. A wildcard is allowed at the end of the target string, to allow using any principal name with the given prefix. The "\*" target means the adapter can create a session in the name of any principal.

### 117.18.4.1 **public DmtPrincipalPermission(String target)**

*target* the name of the principal, can end with \* to match any principal with the given prefix

- Creates a new DmtPrincipalPermission object with its name set to the target string. Name must be non-null and non-empty.

*Throws* NullPointerException– if name is null

IllegalArgumentException– if name is empty

### 117.18.4.2 **public DmtPrincipalPermission(String target,String actions)**

*target* the name of the principal, can end with \* to match any principal with the given prefix

*actions* no actions defined, must be "\*" for forward compatibility

- Creates a new DmtPrincipalPermission object using the 'canonical' two argument constructor. In this version this class does not define any actions, the second argument of this constructor must be "\*" so that this class can later be extended in a backward compatible way.

*Throws* NullPointerException– if name or actions is null

IllegalArgumentException– if name is empty or actions is not "\*"

### 117.18.4.3 **public boolean equals(Object obj)**

*obj* the object to compare to this DmtPrincipalPermission instance

- Checks whether the given object is equal to this DmtPrincipalPermission instance. Two DmtPrincipalPermission instances are equal if they have the same target string.

*Returns* true if the parameter represents the same permissions as this instance

### 117.18.4.4 **public String getActions()**

- Returns the action list (always \* in the current version).

*Returns* the action string "\*"

### 117.18.4.5 **public int hashCode()**

- Returns the hash code for this permission object. If two DmtPrincipalPermission objects are equal according to the equals(Object) method, then calling this method on each of the two DmtPrincipalPermission objects must produce the same integer result.

*Returns* hash code for this permission object

### 117.18.4.6 **public boolean implies(Permission p)**

*p* the permission to check for implication

- Checks if this DmtPrincipalPermission object implies the specified permission. Another DmtPrincipalPermission instance is implied by this permission either if the target strings are identical, or if this target can be made identical to the other target by replacing a trailing "\*" with any string.

*Returns* true if this DmtPrincipalPermission instance implies the specified permission

#### 117.18.4.7 **public PermissionCollection newPermissionCollection()**

- Returns a new PermissionCollection object for storing DmtPrincipalPermission objects.

*Returns* the new PermissionCollection

## 117.19 References

- [1] *OMA DM-TND v1.2 draft*  
[http://member.openmobilealliance.org/ftp/public\\_documents/dm/Permanent\\_documents/OMA-TS-DM-TND-V1\\_2-20050615-C.zip](http://member.openmobilealliance.org/ftp/public_documents/dm/Permanent_documents/OMA-TS-DM-TND-V1_2-20050615-C.zip)
- [2] *OMA DM-RepPro v1.2 draft*  
[http://member.openmobilealliance.org/ftp/public\\_documents/dm/Permanent\\_documents/OMA-DM-RepPro-V1\\_2\\_0-20050131-D.zip](http://member.openmobilealliance.org/ftp/public_documents/dm/Permanent_documents/OMA-DM-RepPro-V1_2_0-20050131-D.zip)
- [3] *IETF RFC2578. Structure of Management Information Version 2 (SMIPv2)*  
<http://www.ietf.org/rfc/rfc2578.txt>
- [4] *Java™ Management Extensions Instrumentation and Agent Specification v1.2, October 2002*,  
<http://www.oracle.com/technetwork/java/javase/tech/javamanagement-140525.html>
- [5] *JSR 9 - Federated Management Architecture (FMA) Specification Version 1.0, January 2000*  
<http://www.jcp.org/en/jsr/detailid=9>
- [6] *WBEM Profile Template, DSP1000*  
Status: Draft, Version 1.0 Preliminary, March 11, 2004  
<http://www.dmtf.org/standards/wbem>
- [7] *SNMP*  
[http://www.wtcs.org/snmp4tpc/snmp\\_rfc.htm#rfc](http://www.wtcs.org/snmp4tpc/snmp_rfc.htm#rfc)
- [8] *RFC 2396 Uniform Resource Identifiers (URI): Generic Syntax*  
<http://www.ietf.org/rfc/rfc2396.txt>
- [9] *MIME Media Types*  
<http://www.iana.org/assignments/media-types/>
- [10] *RFC 3548 The Base16, Base32, and Base64 Data Encodings*  
<http://www.ietf.org/rfc/rfc3548.txt>
- [11] *Secure Hash Algorithm 1*  
<http://www.itl.nist.gov/fipspubs/fip180-1.htm>
- [12] *TR-069 CPE WAN Management Protocol (CWMP)*  
Customer Premises Equipment Wide Area Network Management Protocol (CWMP)  
<http://en.wikipedia.org/wiki/TR-069>
- [13] *XML Schema Part 2: Datatypes Second Edition*  
<http://www.w3.org/TR/2004/PER-xmlschema-2-20040318/>

# 119 Monitor Admin Service Specification

*Version 1.0*

## 119.1 Introduction

Applications and services may publish status information that management systems can receive to monitor the status of the device. For example, a bundle could publish Status Variables for a number key VM variables like the amount of available memory, battery power, number of SMSs sent, etc.

Status Variables can be used in performance management, fault management as well as in customer relations management systems.

This specification outlines how a bundle can publish Status Variables and how administrative bundles can discover Status Variables as well as read and reset their values.

### 119.1.1 Entities

- *Status Variable* - Application specific variables that a *Status Variable Provider* publishes with a Monitorable service to the Monitor Admin service. Status Variable values can be long, double, boolean or String objects.
- *Status Variable Provider* - A bundle which has a number of Status Variables that it publishes with one or more Monitorable services.
- *Monitor Admin* - Provides unified and secure access to available Status Variables as well as providing a function to create monitoring jobs to monitor the Status Variables.
- *Monitorable* - A service that is registered by a Status Variable Provider to publish its Status Variables.
- *Monitor Job* - An event or time based query of a given set of Status Variables. When a monitored Status Variable is updated, or the timer expires, the Monitor Admin must generate an event via the Event Admin service.
- *Local Administrator* - A management application which uses the Monitor Admin service to query Status Variables and to initiate monitoring jobs.
- *Status Variable Name* - The unique name, within a Monitorable service, of a Status Variable.
- *Status Variable Path* - A string that uniquely identifies the Status Variable in an OSGi environment. It consists of the PID of the Monitorable service and the Status Variable name separated by a solidus ('/' \u002F).

Figure 119.1 Monitor Admin Diagram org.osgi.service.monitor package

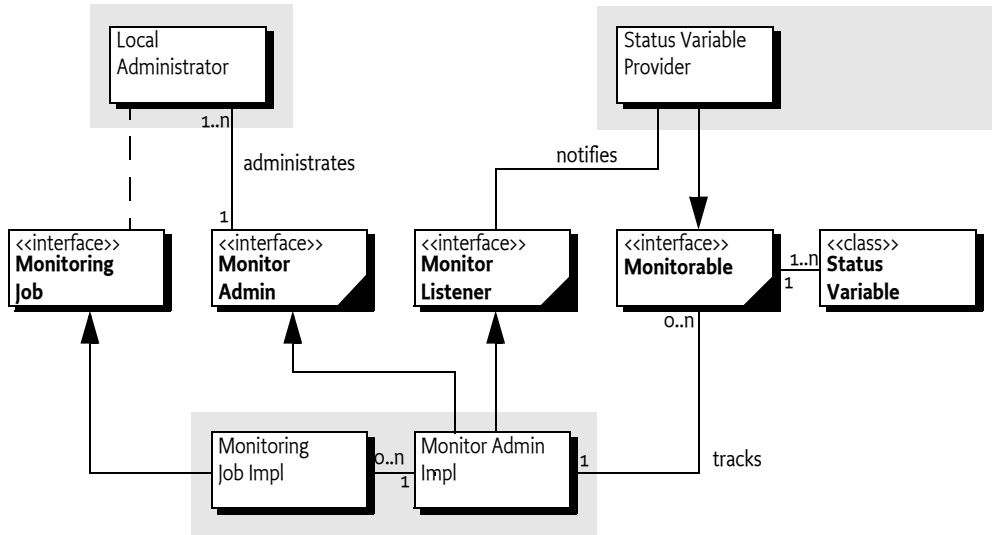

### 119.1.2 Synopsis

A bundle that provides a Status Variable must register a Monitorable service. This service is used by the Monitor Admin to get Status Variables and provide meta information to clients.

Clients can use the Monitor Admin to obtain Status Variables in a protected way. Clients can also create Monitoring Jobs. These Monitoring Jobs send out notifications to the clients when the value changes or periodically.

## 119.2 Monitorable

A Status Variable is a simple scalar that represents some key indicator of the environment, for example amount of available memory. Status Variables are further discussed in *Status Variable* on page 606.

A Status Variable Provider must therefore register a Monitorable service with the service property service.pid set to a PID. This PID must have the following format:

```
monitorable-pid ::= symbolic-name // See General Syntax Definitions in Core
```

The length of this PID must fit in 32 bytes when UTF-8 encoded.

Monitorable services are tracked by the Monitor Admin service. The Monitor Admin service can provide the local administrator unified access to all the Status Variables in the system. This is depicted in Figure 119.2.

Figure 119.2 Access to Status Variables



The main responsibility of a Monitorable service is therefore to provide access to its own Status Variables as well as providing information about those Status Variables.

The Monitorable interface contains the following methods:



- `getStatusVariableNames()` - Provides a list of the Status Variable names. The status variables can subsequently be acquired with the `getStatusVariable(String)` method.
- `getStatusVariable(String)` - Given the name of a Status Variable, return the StatusVariable object, if exists.
- `resetStatusVariable(String)` - Reset the given Status Variable if there is a reasonable reset value. If the Status Variable could not be reset, false is returned. Otherwise true is returned. Resetting a Status Variable triggers a Monitor Event, as described in *Monitoring events* on page 611.
- `notifiesOnChange(String)` - Tells whether the given Status Variable sends a notification when its value changes or when it is reset. This is further discussed in *Providing Notifications* on page 605.
- `getDescription(String)` - Provide a non-localized description of the given Status Variable.

### 119.2.1 Providing Notifications

If a Monitorable service returns true for the `notifiesOnChange(String)` method then it must notify all Monitor Listener services when the related Status Variable changes. These Status Variables are called *dynamic Status Variables*.

After the value of a dynamic Status Variable is changed, the Monitorable service must get *the singleton* Monitor Listener service and call the `updated(String, StatusVariable)` method. The Monitor Admin service must use this notification mechanism to send out a generic event via the Event Admin service, as described in *Monitoring events* on page 611. The Monitor Admin can also use this information to signal a remote server in a proprietary way. Figure 119.3 shows a sequence diagram for such an update. This indirection is required for security reasons.

Figure 119.3 Notification on Update

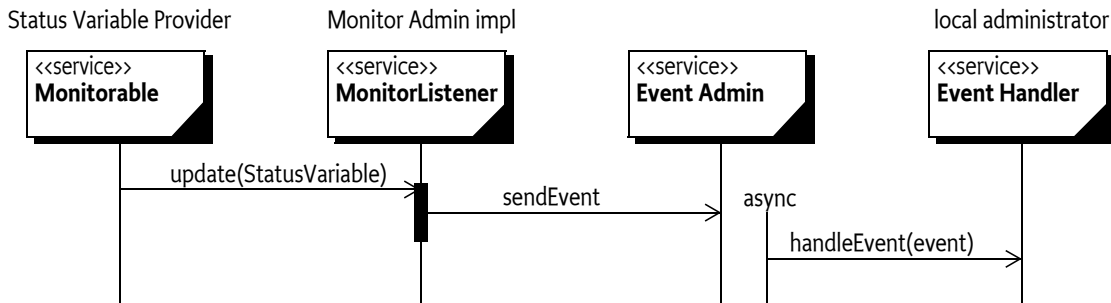

### 119.2.2 Example Monitorable Implementation

The following code shows how a bundle could provide a Status Variable that contains the current amount of memory.

```

public class MemoryMonitor
    implements BundleActivator, Monitorable {

    public void start(BundleContext context) {
        Hashtable ht = new Hashtable();
        ht.put("service.pid", "com.acme.foo");
        context.registerService(
            Monitorable.class.getName(), this, ht);
    }

    public void stop(BundleContext context) {}

    public String[] getStatusVariableNames() {
        return new String[] {"memory.free"};
    }
}
  
```

```
}

public StatusVariable getStatusVariable(String name)
    throws IllegalArgumentException {
    if ("memory.free".equals(name))
        return
            new StatusVariable(name,
                StatusVariable.CM_GAUGE,
                Runtime.getRuntime().freeMemory());
    else
        throw new IllegalArgumentException(
            "Invalid Status Variable name " + name);
}

public boolean notifiesOnChange(String name)
    throws IllegalArgumentException {
    return false;
}

public boolean resetStatusVariable(String name)
    throws IllegalArgumentException {
    return false;
}

public String getDescription(String name)
    throws IllegalArgumentException {
    if ("memory.free".equals(name))
        return "current amount of free memory in the JVM";
    else
        throw new IllegalArgumentException(
            "Invalid Status Variable name " + name);
}
}
```

## 119.3 Status Variable

A Status Variable is a simple value that is published from a Monitorable service. A Status Variable has a name, a value, a timestamp, and a collection method. Additionally, the Monitorable service that publishes the Status Variable can be used to reset the Status Variable and provide a description of it.

The OSGi Specification provides an implementation class for a Status Variable. This class is final and immutable, it must be treated as a value.

### 119.3.1 Name

Each Status Variable must have a unique identity in the scope of a Monitorable service. This identity can be obtained with the `getID()` method. A Status Variable identity must have the following syntax:

```
status-variable-name ::= symbolic-name // See General Syntax Definitions in Core
```

The name should be descriptive and concise. Additionally, it has the following limitations:

- The length must be limited to 32 characters in UTF-8 encoded form.
- It must be unique in the scope of the Monitorable service.

### 119.3.2 Value

A Status Variable provides the type of its value with the `getType()` method. The return value of this method can take the following values:

- `TYPE_BOOLEAN` - A boolean value. The associated method to retrieve the value is `getBoolean()`. The corresponding constructor is `StatusVariable(String,int,boolean)`.
- `TYPE_INTEGER` - A signed numeric value that fits in a Java int type. The associated method to retrieve the value is `getInteger()`. The corresponding constructor is `StatusVariable(String,int,int)`.
- `TYPE_FLOAT` - A floating point value that fits in a Java float type. The associated method to retrieve the value is `getFloat()`. The corresponding constructor is `StatusVariable(String,int,float)`.
- `TYPE_STRING` - A String object. The associated method to retrieve the value is `getString()`. The corresponding constructor is `StatusVariable(String,int,String)`

If a method is called that does not match the return value of the `getType()` method, the Status Variable must throw an Illegal State Exception.

### 119.3.3 Time Stamp

The time stamp must reflect the time that the measurement was taken from the standard Java `System.currentTimeMillis` method. The time stamp can be obtained with the `getTimeStamp()` method.

### 119.3.4 Collection Method

This specification is compatible with terminology used in [2] *ETSI Performance Management [TS 132 403]*. An important concept of a Status Variable is the way it was collected, this is called the *collection method*. The collection method is independent of how (if and when) the reporting of the Status Variables happens. The collection method is part of the Status Variable's definition and cannot be changed. The collection method of a Status Variable can be obtained with the `getCollectionMethod()` method.

The ETSI document defines the following collection methods:

- `CM_CC` - A numeric counter whose value can only increase, except when the Status Variable is reset. An example of a CC is a variable which stores the number of incoming SMSs handled by the protocol driver since it was started or reset.
- `CM_GAUGE` - A numeric counter whose value can vary up or down. An example of a GAUGE is a variable which stores the current battery level percentage. The value of the Status Variable must be the absolute value not a difference.
- `CM_DER` - (Discrete Event Registration) A status variable (numeric or string) which can change when a certain event happens in the system one or more times. The event which fires the change of the Status Variable is typically some event like the arrival of an SMS. The definition of a DER counter contains an integer N which means how many events it takes for the counter to change its value. The most usual value for N is 1, but if N is greater than 1 then it means that the variable changes after each Nth event.
- `CM_SI` - (Status Inspect) The most general status variable which can be a string or numeric. An example of an SI is a string variable which contains the name of the currently logged in user.

## 119.4 Using Monitor Admin Service

The Monitor Admin service is a singleton service that provides unified access to the Status Variables in the system. It provides security checking, resolution of the Status Variable paths and scheduling of periodic or event based Monitoring Jobs.

### 119.4.1 Discovery

The Monitor Admin manages the status variables from any registered Monitorable services. The Monitorable services can be discovered using the `getMonitorableNames()` method. This returns a sorted list of PIDs, potentially empty. This list can contain the PIDs of Monitorable services where the caller has no access to any of its Status Variables.

### 119.4.2 Status Variable Administration

The Monitor Admin provides the following methods for manipulating the Status Variables:

- `getStatusVariable(String)` - Return a Status Variable given a Status Variable path. A path must have the following syntax:
 

```
status-variable-path ::= pid '/' status-variable-name
```
- `getStatusVariableNames(String)` - Returns the Status Variable names given the PID of a Monitorable service.
- `getStatusVariables(String)` - Returns an array of Status Variable objects given the PID of a Monitorable service.
- `resetStatusVariable(String)` - Reset the value of a Status Variable.

Figure 119.4 is the simple sequence diagram for getting a Status Variable from the Monitor Admin service. The caller requests a Status Variable from the Monitor Admin service with the `getStatusVariable(String)` method. Its sole argument specifies a path to the Status Variable. For example:

```
com.acme.foo/memory.free
```

The Monitor Admin service finds the associated Monitorable service by looking for a Monitorable service with the given PID (`com.acme.foo`). It will then query the Monitorable service for the Status Variable `memory.free`, which is then subsequently returned to the caller.

Figure 119.4 Status Variable request through the Monitor Admin service

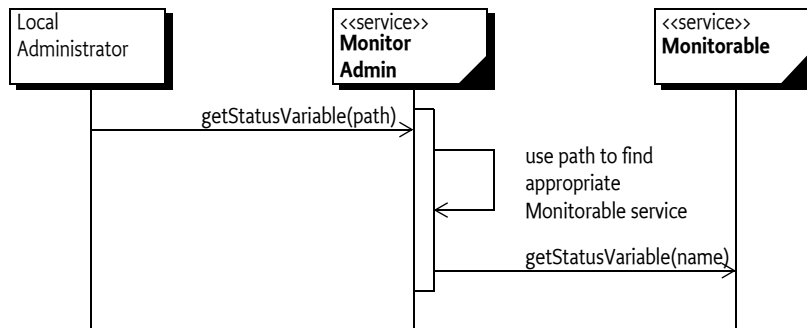

### 119.4.3 Notifications

The Monitor Admin service can receive events from Monitorable services as described in *Providing Notifications* on page 605. The Monitor Admin Service can control the sending of events with the `switchEvents(String,boolean)` method. The argument is a path to a Status Variable, with a possible wildcard character in place of the Status Variable or Monitorable PID. For example:

```

/**
 * com.acme.sv.carots/*
 */received.packets

```

The use of wildcards is the same as described in *Monitor Permission* on page 611. The Monitor Admin service must expand this wildcard to the set of Status Variable names at the time the events are switched. If the boolean argument is set to false, no more events will be sent to the Event Admin service.

The default state is sending events. The state of sending events must not be persistent, switching the events off must not be remembered between system restarts.

### 119.4.4 Monitoring jobs

A local administrator can create a *monitoring job*. A monitoring job consists of a set of Status Variables and *reporting rules*. According to these rules, the Monitor Admin service will send events to the Event Admin service. The same Status Variable can participate in any number of monitoring jobs.

There are two types of monitoring jobs, each created with a different method. One is based on periodic measurements and one based on changes in the value of the Status Variable. The results of the measurements are sent to the Event Admin service, these events are described in *Monitoring events* on page 611.

- `startScheduledJob(String,String[],int,int)` - Start a job based on a periodic measurement. Both the period of measurements as well as the number of measurements can be given.
- `startJob(String,String[],int)` - Start a job based on notifications. The load on the Event Admin service can be minimized by specifying that only every n-th measurement must be reported. Status Variables used with this monitoring job must support notifications, otherwise an `IllegalArgumentException` must be thrown.

Both monitoring jobs take an identification `String` object as first argument. This identification is placed in the properties of the `Event` object under the key: `listener.id`. The initiator of the monitoring job should set this id to a unique value and so that it can discriminate the monitoring events that are related to his monitoring job.

The second argument is a list of paths to Status Variables.

The difference between the Time based monitoring and event based monitoring is further elucidated in Figure 119.5.

Figure 119.5 Time and event based monitoring job

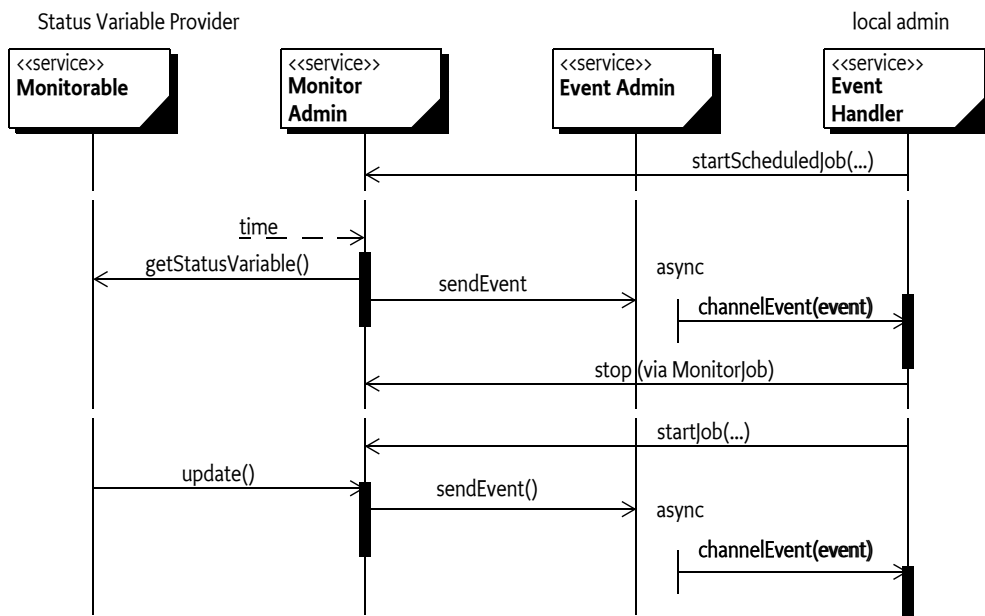

Monitoring jobs can be started also remotely by a management server through Device Management Tree operations. The monitoring job therefore has a boolean method which tells whether it was started locally or remotely: `isLocal()`.

A monitoring job is transient, it must not survive a system restart. A monitoring job can be explicitly stopped with the `stop()` method.

**119.4.4.1****Example Monitoring job**

For example, a bundle is interested in working with periodic samples of the `com.acme.foo/memory.free` Status Variable. It should therefore register an Event Handler with the correct topic and a filter on its Event Handler service. It then starts a monitoring job that is stopped in the `BundleActivator` `stop` method.

```
public class MemoryListener
    implements BundleActivator, EventHandler {
    MonitoringJob job;

    public void start(BundleContext context) throws Exception {
        Hashtable p = new Hashtable();
        p.put(EventConstants.EVENT_TOPIC,
            new String[] { "org/osgi/service/monitor" });
        p.put(EventConstants.EVENT_FILTER,
            "(mon.listener.id=foo.bar)");

        context.registerService(
            EventHandler.class.getName(), this, p );

        job = getMonitorAdmin().startScheduledJob(
            "foo.bar", // listener.id
            new String[] { "com.acme.foo/memory.free" },
            15, // seconds
            0 // Forever
        );
    }

    public void stop(BundleContext ctxt) throws Exception {
        job.stop();
    }

    public void handleEvent(Event event) {
        String value = (String) event.getProperty(
            "mon.statusvariable.value");
        String name = (String) event.getProperty(
            "mon.statusvariable.name");
        System.out.println("Mon: " + name + "=" + value );
    }
    ...
}
```

After starting the job, the Monitor Admin queries the `com.acme.foo/memory.free` Status Variable every 15 seconds. At each acquisition, the Monitor Admin sends a `org/osgi/service/monitor` event to the Event Admin service. The event properties contain the `mon.listener.id` set to `foo.bar`. The Event Admin service updates the Event Handler service that is registered by the example bundle. After receiving the event, the bundle can get the updated value of the Status Variable from the event properties.

The events are therefore repeated once every 15 seconds until the bundle stops.

## 119.5 Monitoring events

The Monitor Admin must send an asynchronous event to the Event Admin service when:

- A Monitorable reported the change on the Monitor Listener service
- The Status Variable was explicitly reset to its starting value with the `resetStatusVariable(String)` method.
- The Status Variable is queried from within a scheduled monitoring job by the Monitor Admin service.

Event sending in the first two cases can be switched on and off, but in the case of monitoring jobs, it cannot be disabled. Monitoring events must be sent asynchronously.

The topic of the event must be:

```
org/osgi/service/monitor/MonitorEvent
```

The properties of the event are:

- `mon.monitorable.pid` - (String) The unique identifier of the Monitorable service which the changed Status Variable.
- `mon.statusvariable.name` - (String) The name of the changed status variable.
- `mon.listener.id` - (String|String[ ]) Name or names representing the initiators of any monitoring jobs in which the Status Variable was included. Listeners can use this field for filtering, so that they receive only events related to their own jobs. If the event is fired because of a notification on the `MonitorListener` interface of the Monitor Admin service (and not because of an measurement taken within a monitoring job) then this property is absent.
- `mon.statusvariable.value` - (String) The value of the status variable in string format. The following methods must be used to format the String object.
  - `long` - `Long.toString(long)`.
  - `double` - `Double.toString(double)`.
  - `boolean` - `Boolean.toString(boolean)`.
  - `String` - No conversion

## 119.6 Security

### 119.6.1 Monitor Permission

Registering Monitorable services, querying and resetting Status Variables and starting monitoring jobs requires a Monitor Permission. If the entity issuing the operation does not have this permission, a Security Exception must be thrown.

Unless noted otherwise, the target of the Monitor Permission identifies the Status Variable paths. It has the following format:

```
wildcard-path ::= wildcard-pid '/' wildcard-name
wildcard-pid  ::= pid '*' | '*'
wildcard-name ::= unique-id '*' | '*'
```

Example:

```
*/*
```

```
com.acme.*/*
*/count
com.acme.foo/memory.free
```

The actions that can be used are:

- **READ** - Reading of the value of the given Status Variables.
- **RESET** - Resetting the given Status Variables.
- **PUBLISH** - Publishing a Status Variable. This does not forbid the Status Variable Provider to register the Monitorable. However, the Monitor Admin must not show a Status Variables to any caller when the Status Variable Provider has no permission to publish that specific Status Variable.
- **STARTJOB** - Initiating monitoring jobs involving the given Status Variables A minimal sampling interval can be optionally defined in the following form:

```
startjob:n
```

The n is the allowed minimal value of the schedule parameter of time based monitoring jobs. If n is not specified or zero then there is no lower limit for the minimum sampling interval specified. The purpose of the minimum sampling interval is to prevent the system from flooding. The target specifies the Status Variables that can be monitored.

- **SWITCHEVENTS** - Switch event sending on or off for the notification of value changes for the given Status Variables.

The permissions must all be checked by the Monitor Admin.

Further, the different actors must have the permissions as specified in the following table to operate correctly.

Table 119.1 *Permission for the different actors*

ServicePermission	Status Variable Provider	Local Admin	Monitor Admin
MonitorAdmin	-	GET	REGISTER
UpdateListener	GET	-	REGISTER
Monitorable	REGISTER	-	GET

## 119.7 org.osgi.service.monitor

Monitor Admin Package Version 1.0.

Bundles wishing to use this package must list the package in the Import-Package header of the bundle's manifest. This package has two types of users: the consumers that use the API in this package and the providers that implement the API in this package.

Example import for consumers using the API in this package:

```
Import-Package: org.osgi.service.monitor; version="[1.0,2.0)"
```

Example import for providers implementing the API in this package:

```
Import-Package: org.osgi.service.monitor; version="[1.0,1.1)"
```

### 119.7.1 Summary

- **Monitorable** - A Monitorable can provide information about itself in the form of StatusVariables.
- **MonitorAdmin** - The MonitorAdmin service is a singleton service that handles StatusVariable query requests and measurement job control requests.



- **MonitoringJob** - A Monitoring Job is a request for scheduled or event based notifications on update of a set of StatusVariables.
- **MonitorListener** - The MonitorListener is used by Monitorable services to send notifications when a StatusVariable value is changed.
- **MonitorPermission** - Indicates the callers authority to publish, read or reset StatusVariables, to switch event sending on or off or to start monitoring jobs.
- **StatusVariable** - A StatusVariable object represents the value of a status variable taken with a certain collection method at a certain point of time.

## 119.7.2 public interface Monitorable

A Monitorable can provide information about itself in the form of StatusVariables. Instances of this interface should register themselves at the OSGi Service Registry. The MonitorAdmin listens to the registration of Monitorable services, and makes the information they provide available also through the Device Management Tree (DMT) for remote access.

The monitorable service is identified by its PID string which must be a non- null, non-empty string that conforms to the "symbolic-name" definition in the OSGi core specification. This means that only the characters [-\_a-zA-Z0-9] may be used. The length of the PID must not exceed 32 characters.

A Monitorable may optionally support sending notifications when the status of its StatusVariables change. Support for change notifications can be defined per StatusVariable.

Publishing StatusVariables requires the presence of the MonitorPermission with the publish action string. This permission, however, is not checked during registration of the Monitorable service. Instead, the MonitorAdmin implementation must make sure that when a StatusVariable is queried, it is shown only if the Monitorable is authorized to publish the given StatusVariable.

### 119.7.2.1 public String getDescription(String id) throws IllegalArgumentException

*id* the identifier of the StatusVariable, cannot be null

- Returns a human readable description of a StatusVariable. This can be used by management systems on their GUI. The null return value is allowed if there is no description for the specified Status Variable.

The given identifier does not contain the Monitorable PID, i.e. it specifies the name and not the path of the Status Variable.

*Returns* the human readable description of this StatusVariable or null if it is not set

*Throws* IllegalArgumentException– if id points to a non-existing StatusVariable

### 119.7.2.2 public StatusVariable getStatusVariable(String id) throws IllegalArgumentException

*id* the identifier of the StatusVariable, cannot be null

- Returns the StatusVariable object addressed by its identifier. The StatusVariable will hold the value taken at the time of this method call.

The given identifier does not contain the Monitorable PID, i.e. it specifies the name and not the path of the Status Variable.

*Returns* the StatusVariable object

*Throws* IllegalArgumentException– if id points to a non-existing StatusVariable

### 119.7.2.3 public String[] getStatusVariableNames()

- Returns the list of StatusVariable identifiers published by this Monitorable. A StatusVariable name is unique within the scope of a Monitorable. The array contains the elements in no particular order. The returned value must not be null.

*Returns* the StatusVariable identifiers published by this object, or an empty array if none are published

**119.7.2.4 public boolean notifiesOnChange(String id) throws IllegalArgumentException**

*id* the identifier of the StatusVariable, cannot be null

- Tells whether the StatusVariable provider is able to send instant notifications when the given StatusVariable changes. If the Monitorable supports sending change updates it must notify the MonitorListener when the value of the StatusVariable changes. The Monitorable finds the MonitorListener service through the Service Registry.

The given identifier does not contain the Monitorable PID, i.e. it specifies the name and not the path of the Status Variable.

*Returns* true if the Monitorable can send notification when the given StatusVariable changes, false otherwise

*Throws* IllegalArgumentException– if *id* points to a non-existing StatusVariable

**119.7.2.5 public boolean resetStatusVariable(String id) throws IllegalArgumentException**

*id* the identifier of the StatusVariable, cannot be null

- Issues a request to reset a given StatusVariable. Depending on the semantics of the actual Status Variable this call may or may not succeed: it makes sense to reset a counter to its starting value, but for example a StatusVariable of type String might not have a meaningful default value. Note that for numeric StatusVariables the starting value may not necessarily be 0. Resetting a StatusVariable must trigger a monitor event.

The given identifier does not contain the Monitorable PID, i.e. it specifies the name and not the path of the Status Variable.

*Returns* true if the Monitorable could successfully reset the given StatusVariable, false otherwise

*Throws* IllegalArgumentException– if *id* points to a non-existing StatusVariable

**119.7.3 public interface MonitorAdmin**

The MonitorAdmin service is a singleton service that handles StatusVariable query requests and measurement job control requests.

Note that an alternative but not recommended way of obtaining StatusVariables is that applications having the required ServicePermissions can query the list of Monitorable services from the service registry and then query the list of StatusVariable names from the Monitorable services. This way all services which publish StatusVariables will be returned regardless of whether they do or do not hold the necessary MonitorPermission for publishing StatusVariables. By using the MonitorAdmin to obtain the StatusVariables it is guaranteed that only those Monitorable services will be accessed who are authorized to publish StatusVariables. It is the responsibility of the MonitorAdmin implementation to check the required permissions and show only those variables which pass this check.

The events posted by MonitorAdmin contain the following properties:

- `mon.monitorable.pid`: The identifier of the Monitorable
- `mon.statusvariable.name`: The identifier of the StatusVariable within the given Monitorable
- `mon.statusvariable.value`: The value of the StatusVariable, represented as a String
- `mon.listener.id`: The identifier of the initiator of the monitoring job (only present if the event was generated due to a monitoring job)

Most of the methods require either a Monitorable ID or a Status Variable path parameter, the latter in [Monitorable\_ID]/[StatusVariable\_ID] format. These parameters must not be null, and the IDs they contain must conform to their respective definitions in Monitorable and StatusVariable. If any of the restrictions are violated, the method must throw an IllegalArgumentException.

**119.7.3.1 public String getDescription(String path) throws IllegalArgumentException, SecurityException**

*path* the full path of the StatusVariable in [Monitorable\_ID]/[StatusVariable\_ID] format

- Returns a human readable description of the given StatusVariable. The null value may be returned if there is no description for the given StatusVariable.

The entity that queries a StatusVariable needs to hold MonitorPermission for the given target with the read action present.

*Returns* the human readable description of this StatusVariable or null if it is not set

*Throws* IllegalArgumentException– if path is null or otherwise invalid, or points to a non-existing Status-Variable

SecurityException– if the caller does not hold a MonitorPermission for the StatusVariable specified by path with the read action present

**119.7.3.2 public String[] getMonitorableNames()**

- Returns the names of the Monitorable services that are currently registered. The Monitorable instances are not accessible through the MonitorAdmin, so that requests to individual status variables can be filtered with respect to the publishing rights of the Monitorable and the reading rights of the caller.

The returned array contains the names in alphabetical order. It cannot be null, an empty array is returned if no Monitorable services are registered.

*Returns* the array of Monitorable names

**119.7.3.3 public MonitoringJob[] getRunningJobs()**

- Returns the list of currently running MonitoringJobs. Jobs are only visible to callers that have the necessary permissions: to receive a Monitoring Job in the returned list, the caller must hold all permissions required for starting the job. This means that if the caller does not have MonitorPermission with the proper startjob action for all the Status Variables monitored by a job, then that job will be silently omitted from the results.

The returned array cannot be null, an empty array is returned if there are no running jobs visible to the caller at the time of the call.

*Returns* the list of running jobs visible to the caller

**119.7.3.4 public StatusVariable getStatusVariable(String path) throws IllegalArgumentException, SecurityException**

*path* the full path of the StatusVariable in [Monitorable\_ID]/[StatusVariable\_ID] format

- Returns a StatusVariable addressed by its full path. The entity which queries a StatusVariable needs to hold MonitorPermission for the given target with the read action present.

*Returns* the StatusVariable object

*Throws* IllegalArgumentException– if path is null or otherwise invalid, or points to a non-existing Status-Variable

SecurityException– if the caller does not hold a MonitorPermission for the StatusVariable specified by path with the read action present

**119.7.3.5 public String[] getStatusVariableNames(String monitorableId) throws IllegalArgumentException**

*monitorableId* the identifier of a Monitorable instance

- Returns the list of StatusVariable names published by a Monitorable instance. Only those status variables are listed where the following two conditions are met:
  - the specified Monitorable holds a MonitorPermission for the status variable with the publish action present

- the caller holds a `MonitorPermission` for the status variable with the read action present

All other status variables are silently ignored, their names are omitted from the list.

The returned array does not contain duplicates, and the elements are in alphabetical order. It cannot be null, an empty array is returned if no (authorized and readable) Status Variables are provided by the given `Monitorable`.

*Returns* a list of `StatusVariable` objects names published by the specified `Monitorable`

*Throws* `IllegalArgumentException`– if `monitorableId` is null or otherwise invalid, or points to a non-existing `Monitorable`

### 119.7.3.6 **public StatusVariable[] getStatusVariables(String monitorableId) throws IllegalArgumentException**

*monitorableId* the identifier of a `Monitorable` instance

- Returns the `StatusVariable` objects published by a `Monitorable` instance. The `StatusVariables` will hold the values taken at the time of this method call. Only those status variables are returned where the following two conditions are met:
  - the specified `Monitorable` holds a `MonitorPermission` for the status variable with the publish action present
  - the caller holds a `MonitorPermission` for the status variable with the read action present

All other status variables are silently ignored, they are omitted from the result.

The elements in the returned array are in no particular order. The return value cannot be null, an empty array is returned if no (authorized and readable) Status Variables are provided by the given `Monitorable`.

*Returns* a list of `StatusVariable` objects published by the specified `Monitorable`

*Throws* `IllegalArgumentException`– if `monitorableId` is null or otherwise invalid, or points to a non-existing `Monitorable`

### 119.7.3.7 **public boolean resetStatusVariable(String path) throws IllegalArgumentException, SecurityException**

*path* the identifier of the `StatusVariable` in `[Monitorable_id]/[StatusVariable_id]` format

- Issues a request to reset a given `StatusVariable`. Depending on the semantics of the `StatusVariable` this call may or may not succeed: it makes sense to reset a counter to its starting value, but e.g. a `StatusVariable` of type `String` might not have a meaningful default value. Note that for numeric `StatusVariables` the starting value may not necessarily be 0. Resetting a `StatusVariable` triggers a monitor event if the `StatusVariable` supports update notifications.

The entity that wants to reset the `StatusVariable` needs to hold `MonitorPermission` with the reset action present. The target field of the permission must match the `StatusVariable` name to be reset.

*Returns* true if the `Monitorable` could successfully reset the given `StatusVariable`, false otherwise

*Throws* `IllegalArgumentException`– if `path` is null or otherwise invalid, or points to a non-existing `StatusVariable`

`SecurityException`– if the caller does not hold `MonitorPermission` with the reset action or if the specified `StatusVariable` is not allowed to be reset as per the target field of the permission

### 119.7.3.8 **public MonitoringJob startJob(String initiator,String[] statusVariables,int count) throws IllegalArgumentException, SecurityException**

*initiator* the identifier of the entity that initiated the job

*statusVariables* the list of `StatusVariables` to be monitored, with each `StatusVariable` name given in `[Monitorable_PID]/[StatusVariable_ID]` format

*count* the number of changes that must happen to a `StatusVariable` before a new notification is sent

- Starts a change based `MonitoringJob` with the parameters provided. Monitoring events will be sent when the `StatusVariables` of this job are updated. All specified `StatusVariables` must exist when the job is started, and all must support update notifications. The initiator string is used in the `mon.listener.id` field of all events triggered by the job, to allow filtering the events based on the initiator.

The count parameter specifies the number of changes that must happen to a `StatusVariable` before a new notification is sent, this must be a positive integer.

The entity which initiates a `MonitoringJob` needs to hold `MonitorPermission` for all the specified target `StatusVariables` with the `startjob` action present.

*Returns* the successfully started job object, cannot be null

*Throws* `IllegalArgumentException`– if the list of `StatusVariable` names contains an invalid or non-existing `StatusVariable`, or one that does not support notifications; if the initiator is null or empty; or if count is invalid

`SecurityException`– if the caller does not hold `MonitorPermission` for all the specified `StatusVariables`, with the `startjob` action present

### 119.7.3.9 **public MonitoringJob startScheduledJob(String initiator,String[] statusVariables,int schedule,int count) throws IllegalArgumentException, SecurityException**

*initiator* the identifier of the entity that initiated the job

*statusVariables* the list of `StatusVariables` to be monitored, with each `StatusVariable` name given in [Monitorable\_PID]/[StatusVariable\_ID] format

*schedule* the time in seconds between two measurements

*count* the number of measurements to be taken, or 0 for the measurement to run until explicitly stopped

- Starts a time based `MonitoringJob` with the parameters provided. Monitoring events will be sent according to the specified schedule. All specified `StatusVariables` must exist when the job is started. The initiator string is used in the `mon.listener.id` field of all events triggered by the job, to allow filtering the events based on the initiator.

The schedule parameter specifies the time in seconds between two measurements, it must be greater than 0. The first measurement will be taken when the timer expires for the first time, not when this method is called.

The count parameter defines the number of measurements to be taken, and must either be a positive integer, or 0 if the measurement is to run until explicitly stopped.

The entity which initiates a `MonitoringJob` needs to hold `MonitorPermission` for all the specified target `StatusVariables` with the `startjob` action present. If the permission's action string specifies a minimal sampling interval then the schedule parameter should be at least as great as the value in the action string.

*Returns* the successfully started job object, cannot be null

*Throws* `IllegalArgumentException`– if the list of `StatusVariable` names contains an invalid or non-existing `StatusVariable`; if initiator is null or empty; or if the schedule or count parameters are invalid

`SecurityException`– if the caller does not hold `MonitorPermission` for all the specified `StatusVariables`, with the `startjob` action present, or if the permission does not allow starting the job with the given frequency

### 119.7.3.10 **public void switchEvents(String path,boolean on) throws IllegalArgumentException, SecurityException**

*path* the identifier of the `StatusVariable(s)` in [Monitorable\_id]/[StatusVariable\_id] format, possibly with the "\*" wildcard at the end of either path fragment

*on* false if event sending should be switched off, true if it should be switched on for the given path

- Switches event sending on or off for the specified `StatusVariable` `s`. When the `MonitorAdmin` is notified about a `StatusVariable` being updated it sends an event unless this feature is switched off. Note that events within a monitoring job can not be switched off. The event sending state of the `StatusVariables` must not be persistently stored. When a `StatusVariable` is registered for the first time in a framework session, its event sending state is set to ON by default.

Usage of the "\*" wildcard is allowed in the path argument of this method as a convenience feature. The wildcard can be used in either or both path fragments, but only at the end of the fragments. The semantics of the wildcard is that it stands for any matching `StatusVariable` at the time of the method call, it does not affect the event sending status of `StatusVariables` which are not yet registered. As an example, when the `switchEvents("MyMonitorable/*", false)` method is executed, event sending from all `StatusVariables` of the `MyMonitorable` service are switched off. However, if the `MyMonitorable` service starts to publish a new `StatusVariable` later, it's event sending status is on by default.

*Throws* `SecurityException`—if the caller does not hold `MonitorPermission` with the `switchevents` action or if there is any `StatusVariable` in the path field for which it is not allowed to switch event sending on or off as per the target field of the permission

`IllegalArgumentException`—if path is null or otherwise invalid, or points to a non-existing `StatusVariable`

## 119.7.4 public interface `MonitoringJob`

A `MonitoringJob` is a request for scheduled or event based notifications on update of a set of `StatusVariables`. The job is a data structure that holds a non-empty list of `StatusVariable` names, an identification of the initiator of the job, and the sampling parameters. There are two kinds of monitoring jobs: time based and change based. Time based jobs take samples of all `StatusVariables` with a specified frequency. The number of samples to be taken before the job finishes may be specified. Change based jobs are only interested in the changes of the monitored `StatusVariables`. In this case, the number of changes that must take place between two notifications can be specified.

The job can be started on the `MonitorAdmin` interface. Running the job (querying the `StatusVariables`, listening to changes, and sending out notifications on updates) is the task of the `MonitorAdmin` implementation.

Whether a monitoring job keeps track dynamically of the `StatusVariables` it monitors is not specified. This means that if we monitor a `StatusVariable` of a `Monitorable` service which disappears and later reappears then it is implementation specific whether we still receive updates of the `StatusVariable` changes or not.

### 119.7.4.1 public `String` `getInitiator()`

- Returns the identifier of the principal who initiated the job. This is set at the time when `MonitorAdmin.startJob` method is called. This string holds the `ServerID` if the operation was initiated from a remote manager, or an arbitrary ID of the initiator entity in the local case (used for addressing notification events).

*Returns* the ID of the initiator, cannot be null

### 119.7.4.2 public `int` `getReportCount()`

- Returns the number of times `MonitorAdmin` will query the `StatusVariables` (for time based jobs), or the number of changes of a `StatusVariable` between notifications (for change based jobs). Time based jobs with non-zero report count will take `getReportCount()*getSchedule()` time to finish. Time based jobs with 0 report count and change based jobs do not stop automatically, but all jobs can be stopped with the `stop()` method.

*Returns* the number of measurements to be taken, or the number of changes between notifications

**119.7.4.3 public int getSchedule()**

- Returns the delay (in seconds) between two samples. If this call returns N (greater than 0) then the MonitorAdmin queries each StatusVariable that belongs to this job every N seconds. The value 0 means that the job is not scheduled but event based: in this case instant notification on changes is requested (at every n-th change of the value, as specified by the report count parameter).

*Returns* the delay (in seconds) between samples, or 0 for change based jobs

**119.7.4.4 public String[] getStatusVariableNames()**

- Returns the list of StatusVariable names that are the targets of this measurement job. For time based jobs, the MonitorAdmin will iterate through this list and query all StatusVariables when its timer set by the job's frequency rate expires.

*Returns* the target list of the measurement job in [Monitorable\_ID]/[StatusVariable\_ID] format, cannot be null

**119.7.4.5 public boolean isLocal()**

- Returns whether the job was started locally or remotely. Jobs started by the clients of this API are always local, remote jobs can only be started using the Device Management Tree.

*Returns* true if the job was started from the local device, false if the job was initiated from a management server through the device management tree

**119.7.4.6 public boolean isRunning()**

- Returns whether the job is running. A job is running until it is explicitly stopped, or, in case of time based jobs with a finite report count, until the given number of measurements have been made.

*Returns* true if the job is still running, false if it has finished

**119.7.4.7 public void stop()**

- Stops a Monitoring Job. Note that a time based job can also stop automatically if the specified number of samples have been taken.

**119.7.5 public interface MonitorListener**

The MonitorListener is used by Monitorable services to send notifications when a StatusVariable value is changed. The MonitorListener should register itself as a service at the OSGi Service Registry. This interface must (only) be implemented by the Monitor Admin component.

**119.7.5.1 public void updated(String monitorableId, StatusVariable statusVariable) throws IllegalArgumentException**

*monitorableId* the identifier of the Monitorable instance reporting the change

*statusVariable* the StatusVariable that has changed

- Callback for notification of a StatusVariable change.

*Throws* IllegalArgumentException– if the specified monitorable ID is invalid (null, empty, or contains illegal characters) or points to a non-existing Monitorable, or if statusVariable is null

**119.7.6 public class MonitorPermission extends Permission**

Indicates the callers authority to publish, read or reset StatusVariables, to switch event sending on or off or to start monitoring jobs. The target of the permission is the identifier of the StatusVariable, the action can be read, publish, reset, startjob, switchevents, or the combination of these separated by commas. Action names are interpreted case-insensitively, but the canonical action string returned by getActions() uses the forms defined by the action constants.

If the wildcard \* appears in the actions field, all legal monitoring commands are allowed on the designated target(s) by the owner of the permission.

#### 119.7.6.1 **public static final String PUBLISH = "publish"**

Holders of MonitorPermission with the publish action present are Monitorable services that are allowed to publish the StatusVariables specified in the permission's target field. Note, that this permission cannot be enforced when a Monitorable registers to the framework, because the Service Registry does not know about this permission. Instead, any StatusVariables published by a Monitorable without the corresponding publish permission are silently ignored by MonitorAdmin, and are therefore invisible to the users of the monitoring service.

#### 119.7.6.2 **public static final String READ = "read"**

Holders of MonitorPermission with the read action present are allowed to read the value of the StatusVariables specified in the permission's target field.

#### 119.7.6.3 **public static final String RESET = "reset"**

Holders of MonitorPermission with the reset action present are allowed to reset the value of the StatusVariables specified in the permission's target field.

#### 119.7.6.4 **public static final String STARTJOB = "startjob"**

Holders of MonitorPermission with the startjob action present are allowed to initiate monitoring jobs involving the StatusVariables specified in the permission's target field.

A minimal sampling interval can be optionally defined in the following form: startjob:n. This allows the holder of the permission to initiate time based jobs with a measurement interval of at least n seconds. If n is not specified or 0 then the holder of this permission is allowed to start monitoring jobs specifying any frequency.

#### 119.7.6.5 **public static final String SWITCHEVENTS = "switchevents"**

Holders of MonitorPermission with the switchevents action present are allowed to switch event sending on or off for the value of the StatusVariables specified in the permission's target field.

#### 119.7.6.6 **public MonitorPermission(String statusVariable,String actions) throws IllegalArgumentException**

*statusVariable* the identifier of the StatusVariable in [Monitorable\_id]/[StatusVariable\_id] format

*actions* the list of allowed actions separated by commas, or \* for all actions

- Create a MonitorPermission object, specifying the target and actions.

The statusVariable parameter is the target of the permission, defining one or more status variable names to which the specified actions apply. Multiple status variable names can be selected by using the wildcard \* in the target string. The wildcard is allowed in both fragments, but only at the end of the fragments.

For example, the following targets are valid: com.mycomp.myapp/queue\_length, com.mycomp.myapp/\*, com.mycomp.\*/\*, \*/\*, \*/queue\_length, \*/queue\*.

The following targets are invalid: \*.myapp/queue\_length, com.\*.myapp/\*, \*.

The actions parameter specifies the allowed action(s): read, publish, startjob, reset, switchevents, or the combination of these separated by commas. String constants are defined in this class for each valid action. Passing "\*" as the action string is equivalent to listing all actions.

*Throws* IllegalArgumentException– if either parameter is null, or invalid with regard to the constraints defined above and in the documentation of the used actions

#### 119.7.6.7 **public boolean equals(Object o)**

*o* the object being compared for equality with this object



- Determines the equality of two MonitorPermission objects. Two MonitorPermission objects are equal if their target strings are equal and the same set of actions are listed in their action strings.

*Returns* true if the two permissions are equal

#### 119.7.6.8 **public String getActions()**

- Get the action string associated with this permission. The actions are returned in the following order: read, reset, publish, startjob, switchevents.

*Returns* the allowed actions separated by commas, cannot be null

#### 119.7.6.9 **public int hashCode()**

- Create an integer hash of the object. The hash codes of MonitorPermissions p1 and p2 are the same if p1.equals(p2).

*Returns* the hash of the object

#### 119.7.6.10 **public boolean implies(Permission p)**

*p* the permission to be checked

- Determines if the specified permission is implied by this permission.

This method returns false if and only if at least one of the following conditions are fulfilled for the specified permission:

- it is not a MonitorPermission
- it has a broader set of actions allowed than this one
- it allows initiating time based monitoring jobs with a lower minimal sampling interval
- the target set of Monitorables is not the same nor a subset of the target set of Monitorables of this permission
- the target set of StatusVariables is not the same nor a subset of the target set of StatusVariables of this permission

*Returns* true if the given permission is implied by this permission

### 119.7.7 **public final class StatusVariable**

A StatusVariable object represents the value of a status variable taken with a certain collection method at a certain point of time. The type of the StatusVariable can be int, float, boolean or String.

A StatusVariable is identified by an ID string that is unique within the scope of a Monitorable. The ID must be a non-null, non-empty string that conforms to the "symbolic-name" definition in the OSGi core specification. This means that only the characters [ \_a-zA-Z0-9 ] may be used. The length of the ID must not exceed 32 bytes when UTF-8 encoded.

#### 119.7.7.1 **public static final int CM\_CC = 0**

Constant for identifying 'Cumulative Counter' data collection method.

#### 119.7.7.2 **public static final int CM\_DER = 1**

Constant for identifying 'Discrete Event Registration' data collection method.

#### 119.7.7.3 **public static final int CM\_GAUGE = 2**

Constant for identifying 'Gauge' data collection method.

#### 119.7.7.4 **public static final int CM\_SI = 3**

Constant for identifying 'Status Inspection' data collection method.

- 119.7.7.5**      **public static final int TYPE\_BOOLEAN = 3**  
Constant for identifying boolean data type.
- 119.7.7.6**      **public static final int TYPE\_FLOAT = 1**  
Constant for identifying float data type.
- 119.7.7.7**      **public static final int TYPE\_INTEGER = 0**  
Constant for identifying int data type.
- 119.7.7.8**      **public static final int TYPE\_STRING = 2**  
Constant for identifying String data type.
- 119.7.7.9**      **public StatusVariable(String id,int cm,int data)**  
*id* the identifier of the StatusVariable  
*cm* the collection method, one of the CM\_ constants  
*data* the int value of the StatusVariable  
□ Constructor for a StatusVariable of int type.  
*Throws* IllegalArgumentException– if the given id is not a valid StatusVariable name, or if cm is not one of the collection method constants  
NullPointerException– if the id parameter is null
- 119.7.7.10**     **public StatusVariable(String id,int cm,float data)**  
*id* the identifier of the StatusVariable  
*cm* the collection method, one of the CM\_ constants  
*data* the float value of the StatusVariable  
□ Constructor for a StatusVariable of float type.  
*Throws* IllegalArgumentException– if the given id is not a valid StatusVariable name, or if cm is not one of the collection method constants  
NullPointerException– if the id parameter is null
- 119.7.7.11**     **public StatusVariable(String id,int cm,boolean data)**  
*id* the identifier of the StatusVariable  
*cm* the collection method, one of the CM\_ constants  
*data* the boolean value of the StatusVariable  
□ Constructor for a StatusVariable of boolean type.  
*Throws* IllegalArgumentException– if the given id is not a valid StatusVariable name, or if cm is not one of the collection method constants  
NullPointerException– if the id parameter is null
- 119.7.7.12**     **public StatusVariable(String id,int cm,String data)**  
*id* the identifier of the StatusVariable  
*cm* the collection method, one of the CM\_ constants  
*data* the String value of the StatusVariable, can be null  
□ Constructor for a StatusVariable of String type.

*Throws* `IllegalArgumentException`– if the given id is not a valid `StatusVariable` name, or if cm is not one of the collection method constants  
`NullPointerException`– if the id parameter is null

**119.7.7.13      public boolean equals(Object obj)**

*obj* the object to compare with this `StatusVariable`

- Compares the specified object with this `StatusVariable`. Two `StatusVariable` objects are considered equal if their full path, collection method and type are identical, and the data (selected by their type) is equal.

*Returns* true if the argument represents the same `StatusVariable` as this object

**119.7.7.14      public boolean getBoolean() throws IllegalStateException**

- Returns the `StatusVariable` value if its type is boolean.

*Returns* the `StatusVariable` value as a boolean

*Throws* `IllegalStateException`– if the type of this `StatusVariable` is not boolean

**119.7.7.15      public int getCollectionMethod()**

- Returns the collection method of this `StatusVariable`. See section 3.3 b) in [ETSI TS 132 403]

*Returns* one of the `CM_` constants

**119.7.7.16      public float getFloat() throws IllegalStateException**

- Returns the `StatusVariable` value if its type is float.

*Returns* the `StatusVariable` value as a float

*Throws* `IllegalStateException`– if the type of this `StatusVariable` is not float

**119.7.7.17      public String getID()**

- Returns the ID of this `StatusVariable`. The ID is unique within the scope of a `Monitorable`.

*Returns* the ID of this `StatusVariable`

**119.7.7.18      public int getInteger() throws IllegalStateException**

- Returns the `StatusVariable` value if its type is int.

*Returns* the `StatusVariable` value as an int

*Throws* `IllegalStateException`– if the type of this `StatusVariable` is not int

**119.7.7.19      public String getString() throws IllegalStateException**

- Returns the `StatusVariable` value if its type is String.

*Returns* the `StatusVariable` value as a String

*Throws* `IllegalStateException`– if the type of the `StatusVariable` is not String

**119.7.7.20      public Date getTimeStamp()**

- Returns the timestamp associated with the `StatusVariable`. The timestamp is stored when the `StatusVariable` instance is created, generally during the `Monitorable.getStatusVariable(String)` method call.

*Returns* the time when the `StatusVariable` value was queried, cannot be null

**119.7.7.21      public int getType()**

- Returns information on the data type of this `StatusVariable`.

*Returns* one of the TYPE\_ constants indicating the type of this StatusVariable

#### 119.7.7.22 **public int hashCode()**

- Returns the hash code value for this StatusVariable. The hash code is calculated based on the full path, collection method and value of the StatusVariable.

*Returns* the hash code of this object

#### 119.7.7.23 **public String toString()**

- Returns a String representation of this StatusVariable. The returned String contains the full path, collection method, timestamp, type and value parameters of the StatusVariable in the following format:

```
StatusVariable(<path>, <cm>, <timestamp>, <type>, <value>)
```

The collection method identifiers used in the string representation are "CC", "DER", "GAUGE" and "SI" (without the quotes). The format of the timestamp is defined by the Date.toString method, while the type is identified by one of the strings "INTEGER", "FLOAT", "STRING" and "BOOLEAN". The final field contains the string representation of the value of the status variable.

*Returns* the String representation of this StatusVariable

## 119.8 References

- [1] *SyncML Device Management Tree Description*
- [2] *ETSI Performance Management [TS 132 403]*  
[http://www.etsi.org/deliver/etsi\\_ts/132400\\_132499/132403/04.01.00\\_60/ts\\_132403v040100p.pdf](http://www.etsi.org/deliver/etsi_ts/132400_132499/132403/04.01.00_60/ts_132403v040100p.pdf)
- [3] *RFC-2396 Uniform Resource Identifiers (URI): Generic Syntax*  
<http://www.ietf.org/rfc/rfc2396.txt>

# 120 Foreign Application Access Specification

## Version 1.0

### 120.1 Introduction

The OSGi Framework contains an advanced collaboration model which provides a publish/find/bind model using *services*. This OSGi service architecture is not natively supported by foreign application models like MIDP, Xlets, Applets, other Java application models. The purpose of this specification is to enable these foreign applications to participate in the OSGi service oriented architecture.

#### 120.1.1 Essentials

- *Interoperability* - Full inter-operability between foreign application models and OSGi services is required. This requires both getting services, registering services, and listening to Framework events.
- *No Change* - The inter-working specification cannot modify the life cycle model of the foreign application models. The foreign application model specifications cannot be changed.
- *Familiarity* - Programmers familiar with a foreign application model should be able to leverage the services architecture without much effort.
- *Simplicity* - The programming model for using services must be very simple and not require the programmer to learn many new concepts.
- *Management* - Support managing the foreign applications; both through proper OSGi APIs and from a remote management server.

#### 120.1.2 Entities

- *Foreign Application* - Java Applications, which must be delivered in JAR files, which are not OSGi bundles.
- *Application Container* - An Application Container is responsible for controlling a foreign application and providing the appropriate environment. It must interact with the OSGi Framework to give the foreign application instances access to the OSGi services and package sharing.
- *Application Activator* - A class in the foreign application JAR file that is used to notify the application of life cycle changes. One JAR file can contain multiple application activators.
- *Framework* - A class that provides access to the application container's *application context* for a given application activator.
- *Application Context* - The interface to the application container's functions to inter-work with the OSGi Framework.
- *Application Declaration* - An XML resource that must be placed in the application's JAR file at OSGI-INF/app/apps.xml. This is an optional declaration.
- *Application Instance* - A launched application. Most foreign application models permit an application to be launched multiple times.

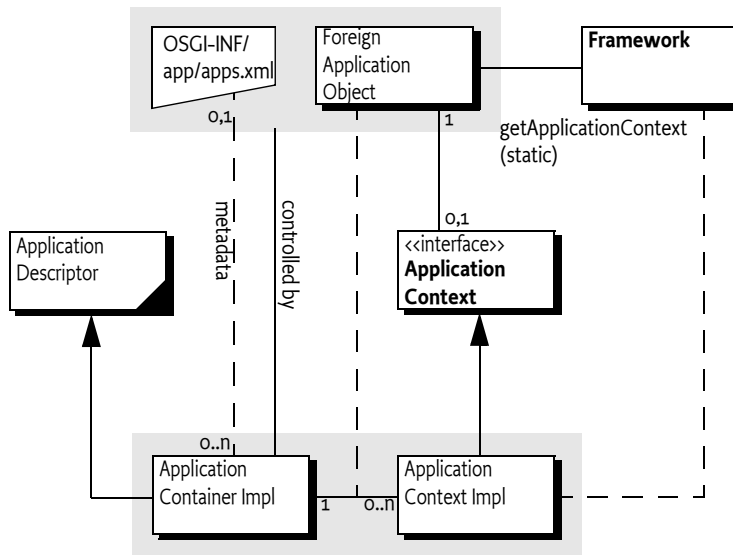
Figure 120.1 Foreign Applications, *org.osgi.application* package

### 120.1.3 Synopsis

Foreign application JAR files can be installed in an OSGi Framework as if they were normal bundles. Application containers running on the OSGi Framework must detect the installation of recognized foreign applications and provide a bridge to the OSGi Environment. This bridge can include interaction with the *Application Admin Specification* on page 447, as well as provide access to the OSGi services and Framework events.

The Application container reads the application XML resource from the JAR file and treats the foreign application according to this information. When the foreign application is launched, the application container creates an application instance.

Foreign application instances can get an application context through a static method on the Framework class. The Application Context provides access to getting services, registering services and registering listeners.

The foreign application instance's life cycle can be influenced by the application declaration. If desired, an application can be prevented from launching or stopping when required services are, or become, unavailable.

## 120.2 Foreign Applications

Foreign applications are Java applications that can be installed and managed through the normal OSGi mechanisms. However, they use another application programming model than the bundle programming model. For example: MIDP, MHP, DOJA.

Foreign applications must fulfill the following requirements to be able to inter-work with the OSGi environment:

- The applications must be written in Java
- The applications must be delivered in JAR files. This is the common model for Java applications.
- They must have a clearly defined life cycle with a start and stop state.
- One or more classes in the application must be available to start and stop the application. For example the Midlet in MIDP or the Xlet in MHP. This object is called the *application's activator*. As

the application container uses this object for life cycle control of the application, the lifetime of this object equals the lifetime of the application.

Foreign applications are managed by *application containers*. Application containers provide the environment and life cycle management as defined by foreign application model.

This specification does not require any changes in the foreign application model; existing applications must run unmodified. However, to allow the foreign applications to participate as a first class OSGi citizen, a number of additional artifacts in the JAR file are required. These artifacts use Manifest headers and an XML resource in the applications JAR file; these artifacts are permitted and ignored by the foreign application models that are currently known.

### 120.2.1 Foreign Metadata

There are different types of metadata associated with application models. Descriptive information, for example the name, icon, documentation etc. of the application, is usually provided in an application model specific way. Application models can also define behavioral metadata, that is, prescribe that the application needs to be started automatically at device startup (auto start) or whether multiple instances of an application can be executed concurrently (singleton). These kinds of metadata are supported by different application models to different extent and are not in the scope of this specification. The application container is responsible for interpreting this metadata and treating the foreign application in the appropriate way.

### 120.2.2 OSGi Manifest Headers

Foreign applications can import packages by specifying the appropriate OSGi module headers in the manifest. These headers are fully described in *OSGi Core Release 6*. Their semantics remain unchanged. The following headers must not be used in foreign applications:

- *Export-Package* - Exporting packages is forbidden in foreign applications.
- *Bundle-Activator* - Foreign applications have their own activator.
- *Service-Component* - Service components should be bundles.

Foreign applications that intend to use the OSGi Framework features should have Bundle-Symbolic-Name and Bundle-Version headers. If they do not have such a header, they can be deployed with Deployment Package, which can assign these headers in the Deployment Package manifest.

Any JAR that uses these headers must not be recognized as a foreign application, even if their manifest is conforming and valid with respect to the foreign application model. This entails that a JAR cannot both be a bundle with activator or exports and a foreign application.

For example, a MIDlet can be extended to import the org.osgi.application package from the OSGi environment. The Import-Package header is used to describe such an import:

```
Manifest-Version: 1.0
MIDlet-Name: Example
MIDlet-1: Example, , osgi.ExampleMidlet
MIDlet-Version: 1.1.0
MIDlet-Vendor: OSGi
MicroEdition-Configuration: CDC-1.0
MicroEdition-Profile: MIDP-1.0
Bundle-ManifestVersion: 2
Bundle-SymbolicName: osgi.example
Import-Package: org.osgi.application; version=1.0,
               org.osgi.framework; version=1.3
```

### 120.2.3 Interacting with the OSGi Framework

The application container must maintain an application context for each started application, that is, the application instance. This context is related to the application's activator. The Application Context can be acquired using a static `getApplicationContext(Object)` method on the `Framework` class. The parameter of this method is the application's activator itself. The `getApplicationContext` method cannot check if the caller is really the given application; the application activator is therefore a *capability*, any application that has this object can get the Application Context. The application activator should never be shared with other applications. The Application Context must therefore deny the application activator to be used as a service object.

The `getApplicationContext` method must not be called from the application activator's constructor; at that time it must not be available yet.

For example, a MIDlet could acquire the application context with the following code:

```
import org.osgi.framework.*;
import org.osgi.application.*;
import javax.microedition.midlet.*;

public class Example extends MIDlet {
    ApplicationContext context;
    public void startApp() {
        context = Framework.getApplicationContext(this);
    }

    public void pauseApp() { ... }

    public void destroyApp(boolean unconditional) { ... }
}
```

The `getApplicationContext` method must throw an `IllegalArgument Exception` if it is called with an object that is not an application's activator.

The `ApplicationContext` object is singleton for the corresponding application's activator. Subsequent calls to the `getApplicationContext` method with the same application's activator must return the same `ApplicationContext` object; therefore, applications are free to forget and get the object any number of times during their lifetime. However, it is an error to get the `ApplicationContext` object for an application that is already stopped. Existing `ApplicationContext` objects must be invalidated once the application's activator is stopped.

### 120.2.4 Introspection

The Application Context provides the following methods about the application:

- `getApplicationId()` - Return the Application Descriptor id for this application.
- `getInstanceId()` - Return the instance id for this application.

### 120.2.5 Access to Services

Foreign applications do not have direct access to the OSGi service registry. However, the application context provides the mechanism to interact with this service registry.

Access to services is more protected and controlled than traditional OSGi access that uses the `BundleContext` object. The service model is conceptually based on the *Declarative Services Specification* on page 289. It uses the same concepts as that specification. Albeit there are a number of differences due the nature of foreign applications.

Applications can use the `locateService` or `locateServices` methods of their associated application context to obtain service objects from the OSGi service registry. Just like OSGi Declarative services,



these service objects must be declared a priori in the reference element of the metadata, see *Application Descriptor Resource* on page 632. This metadata declares a number of *named references*; References contain the criteria which services are eligible for use by the application and how these dependencies should be handled. The foreign application can only use services defined in references; the application context only takes the name of a reference as parameter in the `locateService` and `locateServices` methods. That is, a foreign application cannot indiscriminately use the service registry, it is restricted by the application declaration.

A reference *selects* a subset of services in the service registry. The primary selector is its *interface*. However, this subset can be further narrowed down with a *target* filter. The target specifies an OSGi filter expression that is used to additionally qualify the subset of appropriate services.

There are two different methods to access the services selected by the reference:

- `locateService(String)` - Return one of the services that is selected by the reference with the given name. If multiple services are selected by the reference, then the service with the highest ranking must be returned. This is compatible with the `getServiceReference` method in the OSGi Framework's `BundleContext` class.
- `locateServices(String)` - Return all the services that are selected by the reference with the given name.

Once the application instance has obtained a service object, that service is said to be *bound* to the application instance. There is no method to unbind a service.

For example, a foreign application that wants to log via the Log Service, should declare the following metadata in `OSGI-INF/app/apps.xml`:

```
<?xml version="1.0" encoding="UTF-8"?>
  <descriptor xmlns="http://www.osgi.org/xmlns/app/v1.1.0">
    <application class="com.acme.app.SampleMidlet">
      <reference name="log"
        interface="org.osgi.service.log.LogService"/>
    </application>
  </descriptor>
```

The code to log could look like:

```
void log(String msg) {
    ApplicationContext ctxt=
        Framework.getApplicationContext(this);
    LogService log = (LogService) ctxt.locateService("log");
    log.log( LogService.LOG_INFO, msg );
}
```

## 120.2.6 Service Properties

The foreign applications receive the services objects they have access to directly. This means that they cannot access the service properties that are normally associated with the service registrations.

The `getServiceProperties(Object)` returns a `Map` object with a copy of these service properties.

## 120.2.7 Dependencies on Services

The availability of services can influence the life cycle of the foreign application. The life cycle is influenced by the *policy* and the *cardinality*.

The policy defines how the unregistration of a bound service must be handled. The following policies are supported:

- *static* - The application assumes that bound services will never go away. So if a bound service becomes unregistered, the Application Container must stop the application to prevent it from using a stale service.
- *dynamic* - The application must never store service objects and will always get them on demand. Once a service is bound, it can become unregistered without any effect on the application.

Additionally, the *cardinality* defines if a reference is optional. An optional reference does not influence the life cycle of an application, a mandatory reference does. The cardinality is expressed as one of the following values:

- 0..1 or 0..n - Optional reference
- 1..1 or 1..n - Mandatory reference

The multiplicity is only for compatibility with the Declarative Services. Both `locateService` and `locateServices` methods can be used regardless of the given multiplicity and return the selected subset for the given reference.

Mandatory references can influence the launching of an application. An application must only be started when a mandatory reference is *satisfied*. A reference is satisfied when there is at least one registered service selected by the reference.

If a mandatory reference of an application is about to become unsatisfied, due to unregistering a service, the application container must stop the application instance according to corresponding application model semantics.

### 120.2.8 Registering Services

A common pattern in the OSGi is registering a service to listen to certain events. For example, the Configuration Admin service requires their clients to register a callback Managed Service, so that the service can asynchronously update the client with new configurations. The `ApplicationContext` interface contains methods that allow the applications to register such services. These services must be automatically unregistered by the application container after the application has been stopped.

The available methods are:

- `registerService(String[],Object,Dictionary)` - Register a service under a single interface.
- `registerService(String,Object,Dictionary)` - Register a service under a number of interfaces.

Either method requires that the given object implements all the interfaces that are given. The Dictionary object provides the properties. See the OSGi `registerService` methods in the `BundleContext` class. These identical methods specifies the behavior in detail.

The use of the application activator as a service object is explicitly forbidden. Registering the application activator as a service allows other applications in the OSGi environment to access the Application Context using this object and the `getApplicationContext` method.

Both methods return a `ServiceRegistration` object that can be used to unregister the service. Services must be automatically unregistered when the application instance is stopped.

### 120.2.9 Listening to Service Events

The Application Context provides the following methods to listen to service events:

- `addServiceListener(ApplicationServiceListener,String)` - Add an Application Service Listener. The listener will receive the service events for the given reference name.
- `addServiceListener(ApplicationServiceListener,String[])` - Add an Application Service Listener that will receive the events for all the services identified with the given reference name.

If a `Application Service Listener` is registered more than once, then the previous registration is removed. Listeners can be removed with `removeServiceListener(ApplicationServiceListener)`. When the application instance is stopped, the listeners are automatically unregistered.

### 120.2.10 Access to Startup Parameters

Applications can use the `getStartupArguments` method on the application context to obtain their startup arguments. The startup arguments are represented as map with name and value pairs. The name is a non-null and non-empty ("" ) String object. The value can be any type of object.

The reason for providing the startup parameters through a special mechanism is that it allows foreign applications access to the parameters of a schedule application, see *Scheduling* on page 453.

This uniform access to the startup parameters provides a uniform way for applications of any foreign application model. This facility does not remove the need for any mechanisms required by the foreign application model for startup parameters access.

### 120.2.11 Sibling Instances

Most foreign application models allow an application to be launched multiple times, creating multiple instances. In OSGi, a bundle can only be started once, which creates certain assumptions. For example, the Service Factory concept creates a unique service object per bundle.

Each application instance must be seen as a unique bundle while it runs. That is, it should not share anything with other instances. The foreign application container is responsible for this isolation; implementing this isolation requires implementation dependent constructs.

## 120.3 Application Containers

Application containers:

- Provide management for the foreign applications
- Launches application instances in a defined environment
- Provide a specific application model context to foreign application instances
- Interact with the Application Admin service to provide the foreign applications to application managers.

A single OSGi environment can host multiple application containers.

### 120.3.1 Installation

Applications are installed into the system using OSGi bundle installation mechanism (i.e. `installBundle` method of the `BundleContext` interface). This allows including application JARs to Deployment Packages without any changes to the Deployment Package format or Deployment Admin behavior. It also allows the OSGi framework to process the dependency information (the package dependencies) included in the application metadata.

The application container can listen to the `BundleEvent.INSTALLED` events and examine the installed JARs whether they contain applications supported by the particular container. After the installation, the application container is responsible for registering the corresponding `Application Descriptor` as defined in the *Application Admin Specification* on page 447. Similarly, the container can recognize the removal of the package by listening to `BundleEvent.UNINSTALLED` events and then it can unregister the corresponding descriptors. Additionally, application container must check the bundle registry for changes when they are started.

Receiving `BundleEvent.INSTALLED` events via a Synchronous Bundle Listener makes it possible for the application container to examine the package content during installation. A foreign application

must not become available for execution unless it is started as a bundle. This mechanism allows foreign applications to be installed but not yet recognized as a foreign application.

## 120.4 Application Descriptor Resource

Applications' dependencies on services must be declared in the OSGI-INF/app/apps.xml resource. The XML file must use the `http://www.osgi.org/xmlns/app/v1.1.0` namespace. The preferred abbreviation is `app`. The XML schema definition can be found at *Component Description Schema* on page 633. The `apps.xml` file is optional if a foreign application does not require any dependencies.

The structure of the XML must conform to the description below.

```
<descriptor> ::= <application> +  
<application> ::= <reference> *
```

### 120.4.1 Descriptor Element

The descriptor is the top level element. The descriptor element has no attributes.

### 120.4.2 Application Element

A JAR file can contain multiple application activators. The application element can therefore be repeated one or more times in the descriptor element.

The application element has the following attribute:

- `class` - The class attribute of the application element must contain the fully qualified name of the application's activator.

### 120.4.3 Reference Element

A reference element represents the applications use of a particular service. All services that an application uses must be declared in a reference element.

A reference element has the following attributes:

- `name` - A reference element is identified by a name. This name can be used in the `locateService` or `locateService`, see *Access to Services* on page 628. This name must be unique within an application element.
- `interface` - The fully qualified name of the interface or class that defines the selected service.
- `policy` - The choice of action when a bound services becomes unregistered while an application instance is running. It can have the following values:
  - `static` - If a bound service becomes unregistered, the application instance must be stopped but the corresponding Application Descriptor is still launchable.
  - `dynamic` - If a bound service becomes unregistered, the application can continue to run if the mandatory reference can still be satisfied by another service.
- `cardinality` - Defines the optionality of the reference. If it starts with a 0, an application can handle that the reference selects no service. That is, `locateService` method can return a null. If it starts with 1, the reference is mandatory and at least one service must be available before an application instance can be launched. The cardinality can have one of the following values:
  - `0..1` or `0..n` - Optional reference
  - `1..1` or `1..n` - Mandatory reference
- `target` - The optional target attribute of the element can be used to further narrow which services are acceptable for the application by providing an OSGi filter on the properties of the services.

### 120.4.4 Example XML

The following example is an application declaration for a MIDlet application that depends on the OSGi Log Service and another service:

```
<?xml version="1.0" encoding="UTF-8"?>
<descriptor xmlns="http://www.osgi.org/xmlns/app/v1.1.0">
  <application class="com.acme.apps.SampleMidlet">
    <reference name="log" interface="org.osgi.service.log"/>
    <reference name="foo"
      interface="com.acme.service.FooService"
      policy="dynamic"
      cardinality="0..n" />
  </application>
</descriptor>
```

A similar example for an imaginary Xlet, with different dependencies:

```
<?xml version="1.0" encoding="UTF-8"?>
<descriptor xmlns="http://www.osgi.org/xmlns/app/v1.1.0">
  <application class="com.acme.apps.SampleXlet">
    <reference name="log" interface="org.osgi.service.log"/>
    <reference name="bar"
      interface="com.acme.service.BarService"
      policy="static" cardinality="1..n" />
  </application>
</descriptor>
```

## 120.5 Component Description Schema

This XML Schema defines the component description grammar.

```
<schema xmlns="http://www.w3.org/2001/XMLSchema"
  xmlns:app="http://www.osgi.org/xmlns/app/v1.1.0"
  targetNamespace="http://www.osgi.org/xmlns/app/v1.1.0"
  version="1.1.1">

  <element name="descriptor" type="app:Tdescriptor">
    <annotation>
      <documentation xml:lang="en">
        descriptor element encloses the application descriptors
        provided in a document
      </documentation>
    </annotation>
  </element>

  <complexType name="Tdescriptor">
    <sequence>
      <element name="application" type="app:Tapplication"
        minOccurs="1" maxOccurs="unbounded" />
      <!-- It is non-deterministic, per W3C XML Schema 1.0: http://www.w3.org/TR/xmlschema-1/#cos-nonambig
        to use namespace="##any" below. -->
      <any namespace="##other" processContents="lax" minOccurs="0"
        maxOccurs="unbounded" />
    </sequence>
    <anyAttribute processContents="lax" />
  </complexType>

  <complexType name="Tapplication">
    <annotation>
      <documentation xml:lang="en">
        describes the service dependencies of an application
      </documentation>
    </annotation>
```

```

</annotation>
<sequence>
  <element name="reference" minOccurs="0"
    maxOccurs="unbounded" type="app:Treference" />
  <!-- It is non-deterministic, per W3C XML Schema 1.0: http://www.w3.org/TR/xmlschema-1/#cos-nonambig
    to use namespace="##any" below. -->
  <any namespace="##other" processContents="lax" minOccurs="0"
    maxOccurs="unbounded" />
</sequence>
<attribute name="class" type="string" />
<anyAttribute processContents="lax" />
</complexType>

<complexType name="Treference">
  <sequence>
    <any namespace="##any" processContents="lax" minOccurs="0"
      maxOccurs="unbounded" />
  </sequence>
  <attribute name="name" type="NMTOKEN" use="required" />
  <attribute name="interface" type="string" use="required" />
  <attribute name="cardinality" default="1..1" use="optional"
    type="app:Tcardinality" />
  <attribute name="policy" use="optional" default="static"
    type="app:Tpolicy" />
  <attribute name="target" type="string" use="optional" />
  <anyAttribute processContents="lax" />
</complexType>

<simpleType name="Tcardinality">
  <restriction base="string">
    <enumeration value="0..1" />
    <enumeration value="0..n" />
    <enumeration value="1..1" />
    <enumeration value="1..n" />
  </restriction>
</simpleType>

<simpleType name="Tpolicy">
  <restriction base="string">
    <enumeration value="static" />
    <enumeration value="dynamic" />
  </restriction>
</simpleType>

<attribute name="must-understand" type="boolean">
  <annotation>
    <documentation xml:lang="en">
      This attribute should be used by extensions to documents
      to require that the document consumer understand the
      extension.
    </documentation>
  </annotation>
</attribute>
</schema>

```

## 120.6 Security

### 120.6.1 Application Context Access

The `getApplicationContext` method provides access to the Application Context of a given application activator. The application activator is therefore a capability; any party that has access to this object can potentially get its related Application Context and use it in intended ways.

A common pattern in small applications is to (ab)use the application activator class for all tasks, among them as service object. However, registering the application activator as a service will allow any party that can use that service to use it as the parameter to the `getApplicationContext` method.

The Application Context must therefore be protected to not allow the registration of the application activator.

### 120.6.2 Signing

Application models can include the definition of a security model. For example, MIDP 2 defines a security model different from the standard Java 2 security model. If the foreign application model defines a security model different from Java 2 security, then it is the responsibility of the application container to implement this model and enforce it.

OSGi services are protected by Java 2 permissions. Applications wishing to use such services must have the appropriate permissions for those services.

Java 2 permissions are assigned during class loading based on the location of the code, the JAR signatures, and possibly based on other conditions, when using the Conditional Permission framework.

Signing is a very common technique to handle the granting of permissions. It requires that the JAR be signed according to the JAR Signing model. Therefore, OSGi-aware application packages should be signed by JAR signing. However, some foreign application models have alternative signing models in place. However, it is unlikely that this conflicts because JAR signing uses well defined separate files and manifest headers. If the foreign application model changes the JAR file outside the META-INF directory, then the signing according to the foreign application model must be performed before the standard JAR signing.

For example, in the case of MIDP signing and both models are used, the JAR signature should be put to the file first as it modifies the content of the file, and MIDP signing should be applied afterwards.

### 120.6.3 Permission Management

Applications that use OSGi services must have the corresponding Java 2 permissions granted. In order to simplify the policy management, and ensure that the overall device policy is consistent, application containers should not define separate policy management for each application model; rather they should use the existing OSGi policy management and express the complete security policy by the means of Java 2 permissions with the Conditional Permission Admin service. This way, policy administrator can define the boundaries of the sandbox available for a particular application based on its location, signer or other condition. The application container is responsible for enforcing both the foreign application specific security mechanisms as well as the OSGi granted permissions.

Applications can package permissions as described in the Conditional Permission Admin. These permissions will restrict the foreign application's permissions to maximally the permissions in this file scoped by the signer's permissions.

## 120.7 org.osgi.application

Foreign Application Package Version 1.0.

Bundles wishing to use this package must list the package in the Import-Package header of the bundle's manifest. This package has two types of users: the consumers that use the API in this package and the providers that implement the API in this package.

Example import for consumers using the API in this package:

```
Import-Package: org.osgi.application; version="[1.0,2.0]"
```

Example import for providers implementing the API in this package:

```
Import-Package: org.osgi.application; version="[1.0,1.1]"
```

## 120.7.1 Summary

- `ApplicationContext` - `ApplicationContext` is the access point for an OSGi-aware application to the features of the OSGi Service Platform.
- `ApplicationServiceEvent` - An event from the Framework describing a service lifecycle change.
- `ApplicationServiceListener` - An `ApplicationServiceEvent` listener.
- `Framework` - Using this class, OSGi-aware applications can obtain their `ApplicationContext`.

## 120.7.2 public interface `ApplicationContext`

`ApplicationContext` is the access point for an OSGi-aware application to the features of the OSGi Service Platform. Each application instance will have its own `ApplicationContext` instance, which will not be reused after destroying the corresponding application instance.

Application instances can obtain their `ApplicationContext` using the `Framework.getApplicationContext(Object)` method.

The lifecycle of an `ApplicationContext` instance is bound to the lifecycle of the corresponding application instance. The `ApplicationContext` becomes available when the application is started and it is invalidated when the application instance is stopped (i.e. the "stop" method of the application activator object returned). All method calls (except `getApplicationId()` and `getInstanceId()`) to an invalidated context object result an `IllegalStateException`.

*See Also* `org.osgi.application.Framework`

### 120.7.2.1 public void `addServiceListener(ApplicationServiceListener listener, String referenceName)` throws `IllegalArgumentException`

*listener* The `org.osgi.application.ApplicationServiceListener` to be added. It must not be null

*referenceName* the reference name of a service from the descriptor of the corresponding application. It must not be null.

- Adds the specified `ApplicationServiceListener` object to this context application instance's list of listeners. The specified `referenceName` is a reference name specified in the descriptor of the corresponding application. The registered listener will only receive the `ApplicationServiceEvents` related to the referred service.

If the listener was already added, calling this method will overwrite the previous registration.

*Throws* `IllegalStateException`— If this context application instance has stopped.

`NullPointerException`— If `listener` or `referenceName` is null

`IllegalArgumentException`— If there is no service in the application descriptor with the specified `referenceName`.



**120.7.2.2      public void addServiceListener(ApplicationServiceListener listener,String[] referenceNames) throws IllegalArgumentException**

*listener* The org.osgi.application.ApplicationServiceListener to be added. It must not be null

*referenceNames* and array of service reference names from the descriptor of the corresponding application. It must not be null and it must not be empty.

- Adds the specified ApplicationServiceListener object to this context application instance's list of listeners. The referenceNames parameter is an array of reference name specified in the descriptor of the corresponding application. The registered listener will only receive the ApplicationServiceEvents related to the referred services.

If the listener was already added, calling this method will overwrite the previous registration.

*Throws* IllegalStateException– If this context application instance has stopped.

NullPointerException– If listener or referenceNames is null

IllegalArgumentException– If referenceNames array is empty or it contains unknown references

**120.7.2.3      public String getApplicationId()**

- This method return the identifier of the corresponding application type. This identifier is the same for the different instances of the same application but it is different for different application type.

Note: this method can safely be called on an invalid ApplicationContext as well.

*Returns* the identifier of the application type.

*See Also* org.osgi.service.application.ApplicationDescriptor.getApplicationId()

**120.7.2.4      public String getInstanceId()**

- This method returns the identifier of the corresponding application instance. This identifier is guaranteed to be unique within the scope of the device. Note: this method can safely be called on an invalid ApplicationContext as well.

*Returns* the unique identifier of the corresponding application instance

*See Also* org.osgi.service.application.ApplicationHandle.getInstanceId()

**120.7.2.5      public Map getServiceProperties(Object serviceObject)**

*serviceObject* A service object the application is bound to. It must not be null.

- Application can query the service properties of a service object it is bound to. Application gets bound to a service object when it first obtains a reference to the service by calling locateService or locateServices methods.

*Returns* The service properties associated with the specified service object.

*Throws* NullPointerException– if the specified serviceObject is null

IllegalArgumentException– if the application is not bound to the specified service object or it is not a service object at all.

IllegalStateException– If this context application instance has stopped.

**120.7.2.6      public Map getStartupParameters()**

- Returns the startup parameters specified when calling the org.osgi.service.application.ApplicationDescriptor#launch(Map) method.

Startup arguments can be specified as name, value pairs. The name must be of type java.lang.String, which must not be null or empty java.lang.String (""), the value can be any object including null.

*Returns* a java.util.Map containing the startup arguments. It can be null.

*Throws* `IllegalStateException`– If this context application instance has stopped.

### 120.7.2.7 **public Object locateService(String referenceName)**

*referenceName* The name of a reference as specified in a reference element in this context application's description. It must not be null

- This method returns the service object for the specified `referenceName`. If the cardinality of the reference is 0..n or 1..n and multiple services are bound to the reference, the service with the highest ranking (as specified in its `org.osgi.framework.Constants.SERVICE_RANKING` property) is returned. If there is a tie in ranking, the service with the lowest service ID (as specified in its `org.osgi.framework.Constants.SERVICE_ID` property); that is, the service that was registered first is returned.

*Returns* A service object for the referenced service or null if the reference cardinality is 0..1 or 0..n and no bound service is available.

*Throws* `NullPointerException`– If `referenceName` is null.

`IllegalArgumentException`– If there is no service in the application descriptor with the specified `referenceName`.

`IllegalStateException`– If this context application instance has stopped.

### 120.7.2.8 **public Object[] locateServices(String referenceName)**

*referenceName* The name of a reference as specified in a reference element in this context application's description. It must not be null.

- This method returns the service objects for the specified `referenceName`.

*Returns* An array of service object for the referenced service or null if the reference cardinality is 0..1 or 0..n and no bound service is available.

*Throws* `NullPointerException`– If `referenceName` is null.

`IllegalArgumentException`– If there is no service in the application descriptor with the specified `referenceName`.

`IllegalStateException`– If this context application instance has stopped.

### 120.7.2.9 **public ServiceRegistration registerService(String[] clazzes, Object service, Dictionary properties)**

*clazzes* The class names under which the service can be located. The class names in this array will be stored in the service's properties under the key `org.osgi.framework.Constants.OBJECTCLASS`. This parameter must not be null.

*service* The service object or a `ServiceFactory` object.

*properties* The properties for this service. The keys in the properties object must all be `String` objects. See `org.osgi.framework.Constants` for a list of standard service property keys. Changes should not be made to this object after calling this method. To update the service's properties the `org.osgi.framework.ServiceRegistration.setProperties(Dictionary)` method must be called. The set of properties may be null if the service has no properties.

- Registers the specified service object with the specified properties under the specified class names into the Framework. A `org.osgi.framework.ServiceRegistration` object is returned. The `org.osgi.framework.ServiceRegistration` object is for the private use of the application registering the service and should not be shared with other applications. The registering application is defined to be the context application. Bundles can locate the service by using either the `org.osgi.framework.BundleContext.getServiceReferences(String, String)` or `org.osgi.framework.BundleContext.getServiceReference(String)` method. Other applications can locate this service by using `locateService(String)` or `locateServices(String)` method, if they declared their dependence on the registered service.

An application can register a service object that implements the `org.osgi.framework.ServiceFactory` interface to have more flexibility in providing service objects to other applications or bundles.

The following steps are required to register a service:

1. If service is not a `ServiceFactory`, an `IllegalArgumentException` is thrown if service is not an instance of all the classes named.
2. The Framework adds these service properties to the specified `Dictionary` (which may be null): a property named `org.osgi.framework.Constants.SERVICE_ID` identifying the registration number of the service and a property named `org.osgi.framework.Constants.OBJECTCLASS` containing all the specified classes. If any of these properties have already been specified by the registering bundle, their values will be overwritten by the Framework.
3. The service is added to the Framework service registry and may now be used by others.
4. A service event of type `org.osgi.framework.ServiceEvent.REGISTERED` is fired. This event triggers the corresponding `ApplicationServiceEvent` to be delivered to the applications that registered the appropriate listener.
5. A `ServiceRegistration` object for this registration is returned.

*Returns* A `org.osgi.framework.ServiceRegistration` object for use by the application registering the service to update the service's properties or to unregister the service.

*Throws* `IllegalArgumentException`– If one of the following is true:

- service is null.
- service is not a `ServiceFactory` object and is not an instance of all the named classes in `clazzes`.
- `properties` contains case variants of the same key name.

`NullPointerException`– if `clazzes` is null

`SecurityException`– If the caller does not have the `ServicePermission` to register the service for all the named classes and the Java Runtime Environment supports permissions.

`IllegalStateException`– If this `ApplicationContext` is no longer valid.

*See Also* `org.osgi.framework.BundleContext.registerService(java.lang.String[], java.lang.Object, java.util.Dictionary)`, `org.osgi.framework.ServiceRegistration`, `org.osgi.framework.ServiceFactory`

#### 120.7.2.10 **public ServiceRegistration registerService(String clazz, Object service, Dictionary properties)**

*clazz* The class name under which the service can be located. It must not be null

*service* The service object or a `ServiceFactory` object.

*properties* The properties for this service.

- Registers the specified service object with the specified properties under the specified class name with the Framework.

This method is otherwise identical to `registerService(java.lang.String[], java.lang.Object, java.util.Dictionary)` and is provided as a convenience when service will only be registered under a single class name. Note that even in this case the value of the service's `Constants.OBJECTCLASS` property will be an array of strings, rather than just a single string.

*Returns* A `ServiceRegistration` object for use by the application registering the service to update the service's properties or to unregister the service.

*Throws* `IllegalArgumentException`– If one of the following is true:

- service is null.
- service is not a `ServiceFactory` object and is not an instance of the named class in `clazz`.
- `properties` contains case variants of the same key name.

NullPointerException– if clazz is null

SecurityException– If the caller does not have the ServicePermission to register the service the named class and the Java Runtime Environment supports permissions.

IllegalStateException– If this ApplicationContext is no longer valid.

*See Also* registerService(java.lang.String[], java.lang.Object, java.util.Dictionary)

#### 120.7.2.11 **public void removeServiceListener(ApplicationServiceListener listener)**

*listener* The org.osgi.application.ApplicationServiceListener object to be removed.

- Removes the specified org.osgi.application.ApplicationServiceListener object from this context application instance's list of listeners.

If listener is not contained in this context application instance's list of listeners, this method does nothing.

*Throws* IllegalStateException– If this context application instance has stopped.

### 120.7.3 **public class ApplicationServiceEvent extends ServiceEvent**

An event from the Framework describing a service lifecycle change.

ApplicationServiceEvent objects are delivered to a ApplicationServiceListener objects when a change occurs in this service's lifecycle. The delivery of an ApplicationServiceEvent is always triggered by a org.osgi.framework.ServiceEvent. ApplicationServiceEvent extends the content of ServiceEvent with the service object the event is referring to as applications has no means to find the corresponding service object for a org.osgi.framework.ServiceReference. A type code is used to identify the event type for future extendability. The available type codes are defined in org.osgi.framework.ServiceEvent.

OSGi Alliance reserves the right to extend the set of types.

*See Also* org.osgi.framework.ServiceEvent, ApplicationServiceListener

#### 120.7.3.1 **public ApplicationServiceEvent(int type,ServiceReference reference,Object serviceObject)**

*type* The event type. Available type codes are defines in org.osgi.framework.ServiceEvent

*reference* A ServiceReference object to the service that had a lifecycle change. This reference will be used as the source in the java.util.EventObject base class, therefore, it must not be null.

*serviceObject* The service object bound to this application instance. It can be null if this application is not bound to this service yet.

- Creates a new application service event object.

*Throws* IllegalArgumentException– if the specified reference is null.

#### 120.7.3.2 **public Object getServiceObject()**

- This method returns the service object of this service bound to the listener application instance. A service object becomes bound to the application when it first obtains a service object reference to that service by calling the ApplicationContext.locateService or locateServices methods. If the application is not bound to the service yet, this method returns null.

*Returns* the service object bound to the listener application or null if it isn't bound to this service yet.

### 120.7.4 **public interface ApplicationServiceListener extends EventListener**

An ApplicationServiceEvent listener. When a ServiceEvent is fired, it is converted to an ApplicationServiceEvent and it is synchronously delivered to an ApplicationServiceListener.

ApplicationServiceListener is a listener interface that may be implemented by an application developer.

An ApplicationServiceListener object is registered with the Framework using the `ApplicationContext.addServiceListener` method. ApplicationServiceListener objects are called with an ApplicationServiceEvent object when a service is registered, modified, or is in the process of unregistering.

ApplicationServiceEvent object delivery to ApplicationServiceListener objects is filtered by the filter specified when the listener was registered. If the Java Runtime Environment supports permissions, then additional filtering is done. ApplicationServiceEvent objects are only delivered to the listener if the application which defines the listener object's class has the appropriate ServicePermission to get the service using at least one of the named classes the service was registered under, and the application specified its dependence on the corresponding service in the application metadata.

ApplicationServiceEvent object delivery to ApplicationServiceListener objects is further filtered according to package sources as defined in `ServiceReference.isAssignableTo(Bundle, String)`.

*See Also* ApplicationServiceEvent, ServicePermission

#### 120.7.4.1 **public void serviceChanged(ApplicationServiceEvent event)**

*event* The ApplicationServiceEvent object.

- Receives notification that a service has had a lifecycle change.

#### 120.7.5 **public final class Framework**

Using this class, OSGi-aware applications can obtain their ApplicationContext.

##### 120.7.5.1 **public static ApplicationContext getApplicationContext(Object applicationInstance)**

*applicationInstance* is the activator object of an application instance

- This method needs an argument, an object that represents the application instance. An application consists of a set of object, however there is a single object, which is used by the corresponding application container to manage the lifecycle on the application instance. The lifetime of this object equals the lifetime of the application instance; therefore, it is suitable to represent the instance.

The returned ApplicationContext object is singleton for the specified application instance. Subsequent calls to this method with the same application instance must return the same context object

*Returns* the ApplicationContext of the specified application instance.

*Throws* NullPointerException– If applicationInstance is null

IllegalArgumentException– if called with an object that is not the activator object of an application.

## 120.8 References

- [1] *OSGi Core Release 6*  
<http://www.osgi.org/Specifications/HomePage>



# 121 Blueprint Container Specification

## Version 1.0

### 121.1 Introduction

One of the great promises of object oriented languages was the greater reuse it should enable. However, over time it turned out that reuse was still hard. One of the key reasons was *coupling*. Trying to reuse a few classes usually ended up in dragging in many more classes, that in their turn dragged in even more classes, *ad nauseum*.

One of the key innovations in the Java language to address this coupling issue were *interfaces*. Interfaces significantly could minimize coupling because they were void of any implementation details. Any class can use an interface, where that interface can be implemented by any other class. However, coupling was still necessary because objects need to be created, and for creating an object its concrete class is necessary.

One of the most successful insights in the software industry of late has been *inversion of control*, or more specific *dependency injection*. With dependency injection, an object is given the collaborators that it needs to work with. By not creating these dependencies itself, the object is not coupled to the concrete type of these implementations and their transitive implementation dependencies. However, these objects are not useful on their own, they can only function when an external party provides these objects with their collaborating objects.

An injection framework creates these objects, and also their concrete dependencies, and wires them together. Injection frameworks can significantly increase reuse and provide increased flexibility. For example, during testing it is possible to inject mocked up objects instead of the actual objects.

There exists a number of these injection frameworks in the market, for example [1] *Spring Framework*, [3] *Guice*, and [4] *Picocontainer*. These containers are configured with XML, Java annotations, or provide automatic configuration based on types.

Decoupling is one of the primary drivers for the OSGi specifications. The module layer provides many mechanisms to hide implementation details and explicitly defines any dependencies. The service layer provides a mechanism to collaborate with other bundles without caring about who that other bundle is. However, using the OSGi APIs to construct an application out of services and objects also implies coupling to these OSGi APIs.

This specification therefore defines a dependency injection framework, specifically for OSGi bundles, that understands the unique dynamic nature of services. It provides an OSGi bundle programming model with minimal implementation dependencies and virtually no accidental complexity in the Java code. Bundles in this programming model contain a number of XML definition resources which are used by the Blueprint Container to wire the application together and start it when the bundle is active.

This Blueprint Container specification is derived from the [2] *Spring Dynamic Modules* project.

#### 121.1.1 Essentials

- *Dependency Injection Framework* - Provide an advanced dependency injection framework for bundles that can create and wire objects and services together into an application.
- *Inversion of Control* - (IOC) A pattern in which a framework/library provides the control over the component instances instead of the other way around. Dependency injection is a form of IOC.

- *Extender Model* - Enable the configuration of components inside a bundle based on configuration data provided by the bundle developer. The life cycle of these components is controlled by the extender based on the extended bundle's state.
- *Unencumbered* - Do not require any special bundle activator or other code to be written inside the bundle in order to have components instantiated and configured.
- *Services* - Enable the usage of OSGi services as injected dependencies.
- *Dependencies* - Allow components to depend on other components like services and beans as well as register as services, with the full breadth of the OSGi capabilities.
- *Dynamicity* - Minimize the complexity of using the dynamicity of services
- *Business Logic* - A focus on writing business logic in regular Java classes that are not required to implement certain framework APIs or contracts in order to integrate with a container.
- *Declarative* - This facilitates independent testing of components and reduces environment dependencies.
- *Familiarity* - Familiar to enterprise Java developers.

### 121.1.2

## Entities

- *Blueprint Extender* - The bundle that creates and injects component instances for a Blueprint bundle as configured in that Blueprint bundle's XML definition resources.
- *Blueprint Container* - Represents the activities of the Blueprint Extender for a specific Blueprint Bundle.
- *Blueprint Bundle* - A bundle that is being constructed by the Blueprint Container because it has a Bundle-Blueprint header or it contains XML resources in the OSGI-INF/blueprint directory.
- *Manager* - A manager is responsible for the life cycle of all *component instances* for one *component definition*. There are the following types of managers. A manager is a *bean manager*, a *service reference manager*, or a *service manager*. A manager can have *explicit* and *implicit* dependencies on other manager. During instantiation and runtime, a manager can *provide* a component instance to be injected or used in other ways.
- *Component* - A loosely defined term for the application building blocks and their infrastructure. Components are instantiated into *component instances* by a *manager* that is configured with a *Component Metadata* subclass that is derived from a *Component Definition*.
- *Component Instance* - An object that is part of the application. Component Instances are created and managed by their component *manager*.
- *Component Definition* - Configuration data used by a manager to construct and manage component instances. This configuration data is represented in Metadata, an interface hierarchy starting with the *Metadata* interface.
- *Bean Manager* - A manager that has metadata for creating Java objects and injecting them with objects and component instances that come from other managers it implicitly depends on.
- *Service Manager* - A manager that handles the registration of a service object that is provided by a component instance.
- *Service Reference Manager* - The general name for the reference and reference-list managers.
- *Reference Manager* - A manager that handles the dependency on a single OSGi service.
- *Reference-list Manager* - A manager that handles the dependency on a list of OSGi services.
- *Environment Manager* - A manager that can provide information from the Bundle's environment. For example, the BlueprintContainer object is made available through an environment manager.
- *Target* - A manager type useful in a callback context. These are the ref (which is an indirection to), a reference, and a bean manager.
- *Property* - A conceptual instance variable of a component instance provided by a bean manager that is set on the component instance with a corresponding set<Name> method.
- *Argument* - Metadata for an argument in a constructor or method.



- *Type Converter* - A component instance defined, or referenced, in the type-converters section implementing the Converter interface.

Figure 121.1 *Blueprint Class and Service Overview*

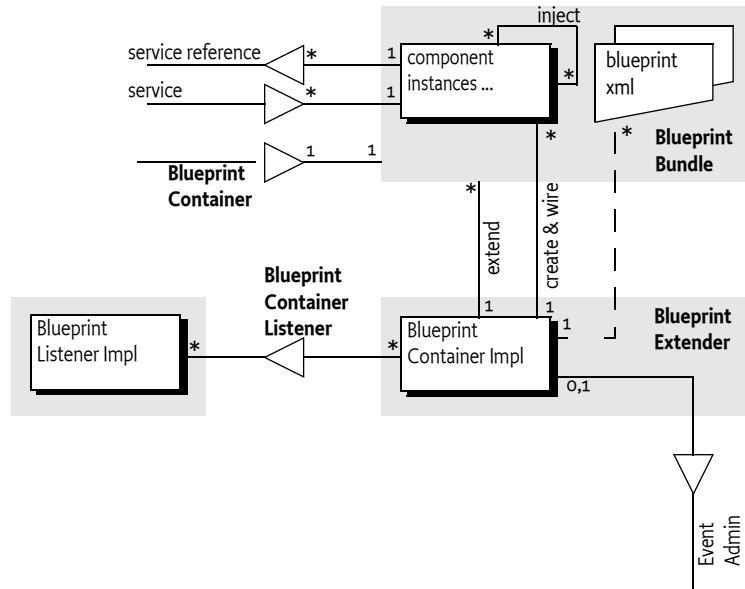

### 121.1.3 Synopsis

The Blueprint Extender bundle waits for Blueprint bundles. These are bundles that contain Blueprint XML resources called the definitions. These XML resources can be found in a fixed location or pointed to from a manifest header. When a Blueprint extender bundle detects that a Blueprint bundle is ready, it creates a Blueprint Container to manage that Blueprint bundle.

The Blueprint Container then parses the definitions into metadata objects. All top-level elements in the definitions are ComponentMetadata objects and are registered in the Blueprint Container by their id.

For each of the ComponentMetadata objects, the Blueprint Container has a corresponding component manager. For example, a BeanMetadata object relates to a Bean Manager instance. There are the following types of managers:

- *Bean Managers* - Can provide general objects that are properly constructed and configured
- *Service Managers* - Can register services
- *Service Reference Managers* - Provide proxies to one or more services. There are two sub-types: reference-list and reference.
- *Environment Managers* - Holding environment values like the Blueprint Bundle object

After creation, all managers are not yet activated. A manager is activated on demand when it has to provide a component instance for the first time.

All service reference managers track services in the service registry in order to determine if they are satisfied or not. If not, the Blueprint Container can optionally start a *grace* period. During the grace period, the Blueprint Container waits for all mandatory service reference managers to become satisfied. If this does not happen during the grace period, the Blueprint Container must abort the initialization.

From now on, the Blueprint Container is ready to provide component instances. Whenever a manager is asked to provide a component instance for the first time, the manager is activated. This acti-

vation will first request all its dependencies to provide a component instance, activating these managers if not already activated, recursively.

However, the activation needs a trigger to start. There are two triggers.

- *Service Request* - All service managers must have a Service Factory registered with the OSGi service registry whenever that service manager is enabled, see *Enabled* on page 676.
- *Eager Managers* - To kick start the application in the bundle, the Blueprint Container must ask all eager managers to provide a component instance, thereby activating these managers, see *Eager Instantiation* on page 658.

Service references must actuate their reference listeners when they are activated.

Bean managers have a scope. This scope can be singleton, where the manager always provides the same object, or prototype, where the manager creates a new object for each request.

Service reference managers provide proxies to the actual service objects and fetch the service object lazily. They provide a constant reference that dampen the dynamics of the underlying service objects.

If the Blueprint Container has successfully activated the eager managers, it will register a Blueprint Container service.

When the Blueprint Container must be destroyed because: the Blueprint bundle has stopped, there is a failure, or the Blueprint extender is stopped, then the Blueprint Container service is unregistered and all managers are deactivated. This will unregister any services and disable listeners, which release the component instances. Then all component instances are destroyed in reverse dependency order. That is, a component instance is destroyed when no other component instances depend on it.

## 121.2 Managers

The key feature of the Blueprint Container specification is to let the application in the bundle be constructed in the proper order from objects that are not required to be aware of Blueprint, OSGi, or even each other. These objects are called *component instances*. The active entity that orchestrates the life cycle of the bundle application is the *Blueprint Container*. It is configured by XML resources in the Blueprint bundle. The Blueprint Container is responsible for construction and configuration of the component instances as well as the interaction with the service registry.

Inside the Blueprint Container, component instances are managed by a *manager*. A manager is configured with one Component Definition, for example a bean definition, and can then provide one or more component instances. Such a configured manager instance is also loosely called a *component*.

A manager can have additional behavior associated with it. This behavior is controlled by the manager's *type*. This specification defines a number of manager types: bean, service, environment, reference, and reference-list. These types are further defined in the next section.

These managers are conceptual, they are not visible in the API of this specification. That is, an implementation is free to implement the specification without these objects as long as the externally observable behavior is the same.

As an example, a trivial echo service:

```
<blueprint>
  <service id="echoService"
    interface="com.acme.Echo" ref="echo"/>
  <bean id="echo" class="com.acme.EchoImpl">
    <property name="message" value="Echo: "/>
  </bean>
```

```
</blueprint>

public interface Echo {
    public String echo(String m);
}
public class EchoImpl implements Echo {
    String message;
    public void setMessage(String m) {
        this.message= m;
    }
    public void echo(String s) { return message + s; }
}
```

The example defines two *top-level* managers: `echoService` and `echo`. The `echoService` manager is of type *service*, and the `echo` manager is of type *bean*. The service manager is responsible for registering an OSGi service, where the service object will be the component instance provided by the `echo` manager. The `echo` component instance gets a message injected.

As seen from the example, managers can use component instances from other managers to construct their component instances. The use of other managers creates an *implicit dependency*. Managers can also declare *explicit dependencies*. Dependencies are transitive, see *Manager Dependencies* on page 649 for more information. In the previous example, the `echoService` service manager depends on the `echo` manager, this is an implicit dependency.

Managers have their own life cycle. They are conceptually created after the Blueprint Container has decided to run the application, see *Blueprint Life-Cycle* on page 653. However, the intention of this specification is to allow the bundle application to lazily *activate*. That is, no application code is used until there is a trigger like a service request or a service manager has an explicit dependency. A manager must always be atomically activated before it provides its first component instance. During activation, listeners are actuated and notified, service objects are requested, etc. The details are described in the appropriate manager's type description.

Each manager type has an associated *component metadata* type. Component Metadata is used to configure a manager. XML definition resources in the bundle define the source for this Metadata. In the previous example, the `service` and `bean` XML element are translated to a `ServiceMetadata` and `BeanMetadata` object respectively.

The Blueprint Container maintains a registry of managers by their *id*. These are the managers that are called the *top-level* managers. Top level managers are managers defined as child elements of the top XML blueprint element or bean managers in the `type-converters` element. Their Metadata is registered under their *id* (or calculated *id*) in the Blueprint Container. All top level managers share a single namespace. That is, it is an error if the same *id* is used multiple times or attempts to override the built-in environment managers.

Top level managers can depend on other top level managers but there are many places where a manager can depend on an *inlined* manager. In these places, a complete manager can be defined inside another manager. Such inlined managers are always *anonymous*: they must not have an *id* and must not be registered as a top-level manager. Inlined beans are further constrained to always have prototype scope. That is, every time they are asked to provide a component instance, they must return a different object.

When the Blueprint Container must be *destroyed*, all singleton component instances that have been created must be destroyed. This must first *deactivate* all activated managers. All these managers must release their dependencies on any component instances they hold. Then the Blueprint Container must destroy all singleton component instances. The order of this destruction must be such that a component instance is only destroyed if there are no other component instances depending on it. See *Reverse Dependency Order* on page 650.

The relations between manager types, component instances, metadata and the Blueprint Container is schematically depicted in Figure 121.2 on page 648.

Figure 121.2 *Managers and Metadata*

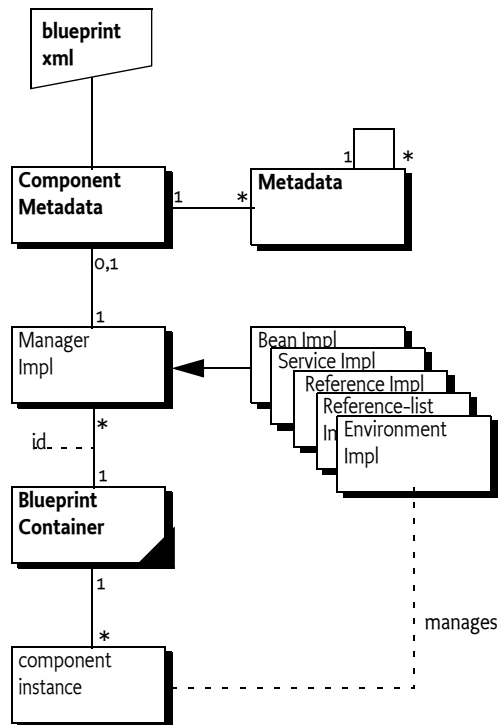

### 121.2.1 Manager Types

Blueprint only supports a fixed set of the following *manager types*:

- *Bean* - A bean manager provides regular Java objects as component instances. It has the following features:
  - Construction via class name, static factory method, or a factory method on a *target*. A *target* is a reference to a top level manager of type bean or service reference, or a referral to a top level manager of those types.
  - Can have *arguments* for a constructor or factory method.
  - Can have *properties* that are injected.
  - Manages a singleton or creates objects on demand depending on its *scope*.
  - Life cycle callbacks for end of initialization and destruction.

See *Bean Manager* on page 664 for more details.

- *Reference* - Reference managers track a service in the OSGi service registry. When activated, they provide a proxy to a service object. See *Service Reference Managers* on page 676 for more details. A reference is satisfied when its selection matches a service in the registry.
- *Reference-list* - Reference-list managers track multiple services. A reference-list is satisfied when its selection matches one or more services in the registry. See *Service Reference Managers* on page 676 for more details.
- *Service* - Service managers maintain the registration of an OSGi service object. Service managers provide a proxied ServiceRegistration object so that the application code has a constant reference, even if the service is unregistered and then registered again. A service manager is *enabled*

if all the mandatory service references in its dependencies are satisfied. See *Service Manager* on page 670.

- *Environment* - Environment managers provide access to the environment of the Blueprint bundle, for example its Bundle Context. See *Blueprint Container* on page 698 for more details.

### 121.2.2 Metadata Objects

Metadata objects hold the configuration information (from the Component Definition) for the managers. These metadata objects represent the element structure found in the XML definitions in canonical form. Each element in the XML has a corresponding Metadata sub-type that has a name that maps directly to the element. For example, the bean element represents the bean manager that has its configuration data defined in the BeanMetadata interface.

There are Metadata interfaces for all the manager types, except the environment type. Some dependency injections require the construction of arrays, maps, properties, simple objects, etc. For these type of objects, additional Metadata sub-interfaces are defined; these interfaces provide the information to construct the basic programming types. For example, the CollectionMetadata interface contains the information to construct an Array or Collection of a given type, where its member values are defined by other Metadata objects.

The set of Metadata types is fixed in this specification, just like the set of manager types. It is impossible to extend this set with user defined Metadata types. For more information about Metadata, see *Metadata* on page 703.

### 121.2.3 Activation and Deactivation

Managers are created after all the definitions are parsed. Some managers can already show some activity, for example service managers always activate explicit dependencies and register a Service Factory with the OSGi service registry. However, in this state a manager should attempt to not use any resources from the Blueprint bundle until it is activated itself.

A manager must be atomically activated when it has to provide its first component instance. During activation it can perform a manager specific initialization that will actually consume resources from the Blueprint bundle. This activation must be atomic. That is, if a manager is being activated then other threads must block until the activation is completed.

Deactivation only happens during the destruction of the Blueprint Container. During deactivation, a manager must release any dependencies on resources of the Blueprint bundle. No components instances are destroyed during deactivation because the singleton component instance destruction must happen after all managers are deactivated.

Each manager type has a dedicated section that describes what must happen during its activation and deactivation.

### 121.2.4 Manager Dependencies

Managers that refer to other managers depend on these managers transitively. For example, a service manager depends directly on the manager that provides the service object. In its turn, that service object could depend on any provided objects that were used to construct and inject this service object, and so on. This transitive set of dependencies are called *implicit dependencies* because these dependencies are implicitly created by the use of other managers in the Component Definitions.

Managers can also be configured with *explicit dependencies*. The XML definitions for all managers have a depends-on attribute with a whitespace delimited list of manager ids. Each of these depends-on managers must provide an object, that will be ignored. The timing of activation of dependencies depends on the specific managers but in general should happen before any observable behavior.

There is no ordering guarantee between independent sets of dependencies. The dependency graph is based on the managers, not the component instances. For example, the following definition:



to account. The destruction of component instance b frees up component instance e and c because now the explicit dependency from manager B to manager E and manager B to manager C have been released. Manager C is deactivated but no component instances are destructed because it has prototype scope; these managers do not destroy their component instances. Then component instance d can be destructed.

## 121.2.6 Cyclic Dependencies

The implicit and explicit dependencies of a component form a dependency graph. In the ideal case, this graph should be free from *cycles*. A cycle occurs when a set of one or more managers find themselves in their own implicit or explicit dependencies. For example:

```
public class A { public A(B b); }
public class B { public void setA(A a); }

<bean id="a" class="A"> <argument ref="b"/> </bean>
<bean id="b" class="B"> <property name="a" ref="a"/> </bean>
```

In this example, the cycle is the set {a,b}. Managers can be part of multiple cycles.

When a member of a cycle is requested to provide a component instance, the Blueprint Container must break the cycle by finding one *breaking member* in the cycle's members. A breaking member must be a singleton bean and use property injection for the dependency that causes the cycle. The Blueprint Container can pick any suitable member of the cycle for breaking member, if no such member can be found, then initialization fails or the `getComponentInstance` method must throw a Component Definition Exception.

In the previous example, manager b can be a breaking member because it uses the property injection for the cyclic dependency on manager a. Manager a cannot be a breaking member because the cyclic dependency is caused by a constructor argument, a breaking member must use property injection for the cyclic dependency to be broken.

A breaking member must return a partially initialized component instance when it is asked to provide an object. A partially initialized object has done all possible initialization but has not yet been called with the `initMethod` (if specified) nor has it been injected any of the properties that causes a cycle. The *finalization* of the partially initialized component instance must be delayed until the breaking member has been injected in all referring members of the cycles. Finalization means injecting any remaining unset properties and calling of the `initMethod`, if specified.

The consequence of partially initialized component instances is that they can be used before they have all properties set, applications must be aware of this.

All partially initialized component instances must be finalized before the Blueprint Container enters the Runtime phase and before a call to the `getComponentInstance` method returns a component instance.

All detected cycles should be logged.

Consider the following example:

```
public class A {
    public A(B b) {}
}
public class B {
    public B(A a) {}
}
```

And the configuration:

```
<bean id="a" class="A"> <argument ref="b"/> </bean>
```

```
<bean id="b" class="B"> <argument ref="a"/> </bean>
```

In this case, the cycle cannot be broken because neither manager qualifies as breaking manager because they have a constructor/factory argument dependency. That is, it is impossible to construct an object without using the dependency. However, consider the following example:

```
public class A {
    public A(B b) {}
}
public class B {
    public B(C c) {}
}
public class C {
    public void setA(A a) {}
}
```

And the configuration:

```
<bean id="a" class="A"> <argument ref="b"/> </bean>
<bean id="b" class="B"> <argument ref="c"/> </bean>
<bean id="c" class="C" init-method="done">
    <property name="a" ref="a"/>
</bean>
```

This configuration is depicted in Figure 121.4 on page 652. This cycle {a,b,c} can be broken by selecting manager c as the breaking member. If manager a is requested to provide a component instance for the first time, then the following sequence takes place:

```
activate a
  activate b
    activate c
      c = new C()
      b = new B(c)
      a = new A(b)
      c.setA(a)
      c.done()
return a
```

Figure 121.4

Cyclic Dependency

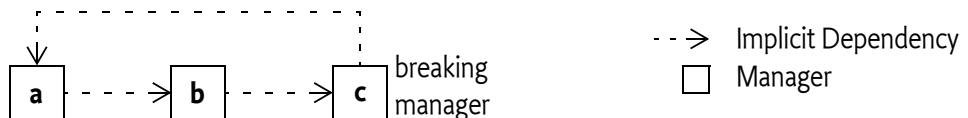

Cycles must be broken, if possible, both for singleton managers as well as prototype beans, although a breaking manager must always be a singleton bean because a prototype bean must always return a new object, making it impossible to break the cycle by returning a partially initialized component instance. That is, the following definition is not allowed to attempt to create an infinite loop:

```
<bean id="a" scope="singleton" class="A">
    <property name="a" ref="a">
</bean>
```

The previous definition must create an A object that refers to itself. However, if the example had used a prototype scope, it would be an unbreakable cycle.



### 121.2.7 Eager Managers

The Blueprint Container can force the activation of the application in the Blueprint bundle with *eager* managers. An eager manager is a manager that has the activation set to eager. A bean manager can only be eager if it has singleton scope.

Eager managers are explicitly activated by asking them to provide a component instance after all other initialization is done. A bundle that wants to be lazily initialized should not define any eager managers.

## 121.3 Blueprint Life-Cycle

A bundle is a *Blueprint bundle* if it contains one or more blueprint XML *definition* resources in the OSGI-INF/blueprint directory or it contains the Bundle-Blueprint manifest header referring to existing resources.

A *Blueprint extender* is an implementation of this specification and must track blueprint bundles that are *type compatible* for the Blueprint packages and initialize them appropriately. The timing and ordering of the initialization process is detailed in the following section.

There should be only one Blueprint extender present in an OSGi framework because this specification does not specify a way to resolve the conflicts that arise when two Blueprint extenders extend the same Blueprint bundle.

### 121.3.1 Class Space Compatibility

A Blueprint extender must not manage a Blueprint bundle if there is a class space incompatibility for the `org.osgi.service.blueprint` packages. For example, if the Blueprint bundle uses the `BlueprintContainer` class, then it must import the `org.osgi.service.blueprint.container` package. The Blueprint extender and the Blueprint bundle must then share the same class space for this package. Type compatibility can be verified by loading a class from the blueprint packages via the Blueprint extender bundle and the Blueprint bundle's `loadClass` methods. If the Blueprint bundle cannot load the class or the class is identical to the class loaded from the extender, then the two bundles are compatible for the given package. If the Blueprint extender is not class space compatible with the Blueprint bundle, then Blueprint extender must not start to manage the Blueprint bundle.

### 121.3.2 Initialization of a Blueprint Container

A Blueprint extender manages the application life cycle of Blueprint bundles based on:

- The Blueprint bundle state,
- The Blueprint definitions,
- The Blueprint extender's bundle state
- The class space compatibility

All activities on behalf of the Blueprint bundle must use the Bundle Context of the Blueprint bundle. All dynamic class loads must use the Blueprint bundle's `Bundle loadClass` method.

The following sections describe a linear process that handles one Blueprint bundle as if it was managed by a special thread, that is, waits are specified if the thread waits. Implementations are likely to use a state machine instead for each managed Blueprint bundle, the linear description is only used for simplicity.

In the following description of the initialization steps, the Blueprint Container will update its state. State changes are broadcast as events, see *Events* on page 699.

If any failure occurs during initialization, or the Blueprint bundle or Blueprint extender bundle is stopped, the Blueprint Container must be destroyed, see *Failure* on page 654. These checks are not indicated in the normal flow for clarity.

### 121.3.2.1 Initialization Steps

The initialization process of a Blueprint Container is defined in the following steps:

1. Wait until a blueprint bundle is *ready*. A blueprint bundle is ready when it is in the ACTIVE state, and for blueprint bundles that have a lazy activation policy, also in the STARTING state.
2. Prepare, verify if this Blueprint bundle must be managed, see *Preparing* on page 656.
3. State = CREATING
4. Parse the XML definition resources.
5. Service reference managers must start tracking their satisfiability without actually activating. See *Tracking References* on page 657.
6. If all mandatory service references are satisfied, or the blueprint.graceperiod is false, then go to step 9.
7. State = GRACE\_PERIOD
8. Perform the *grace period*. This period waits until all mandatory service references are satisfied. See *Grace Period* on page 657. This step fails if the mandatory dependencies are not satisfied at the end of the grace period.
9. The Blueprint Container is now ready to provide component instances.
10. Service managers must initialize their explicit dependencies and have a Service Factory registered during the periods that they are enabled. See *Service Registration* on page 657.
11. Ask all eager managers to provide a component instance. See *Eager Instantiation* on page 658.
12. State = CREATED
13. Register the Blueprint Container
14. The components are now active and perform their function until the Blueprint bundle or the Blueprint extender bundle are stopped.
15. State = DESTROYING
16. Perform the Destroy phase, see *Destroy the Blueprint Container* on page 658.
17. State = DESTROYED

### 121.3.2.2 Failure

If at any time there is a failure, the Blueprint Container must:

1. State = FAILURE
2. Unregister the Blueprint Container service.
3. Destroy the Blueprint Container.
4. Wait for the Blueprint bundle to be stopped.

### 121.3.2.3 Diagram

This initialization process is depicted in Figure 121.5 on page 655.

Figure 121.5 Blueprint Bundle Initialization

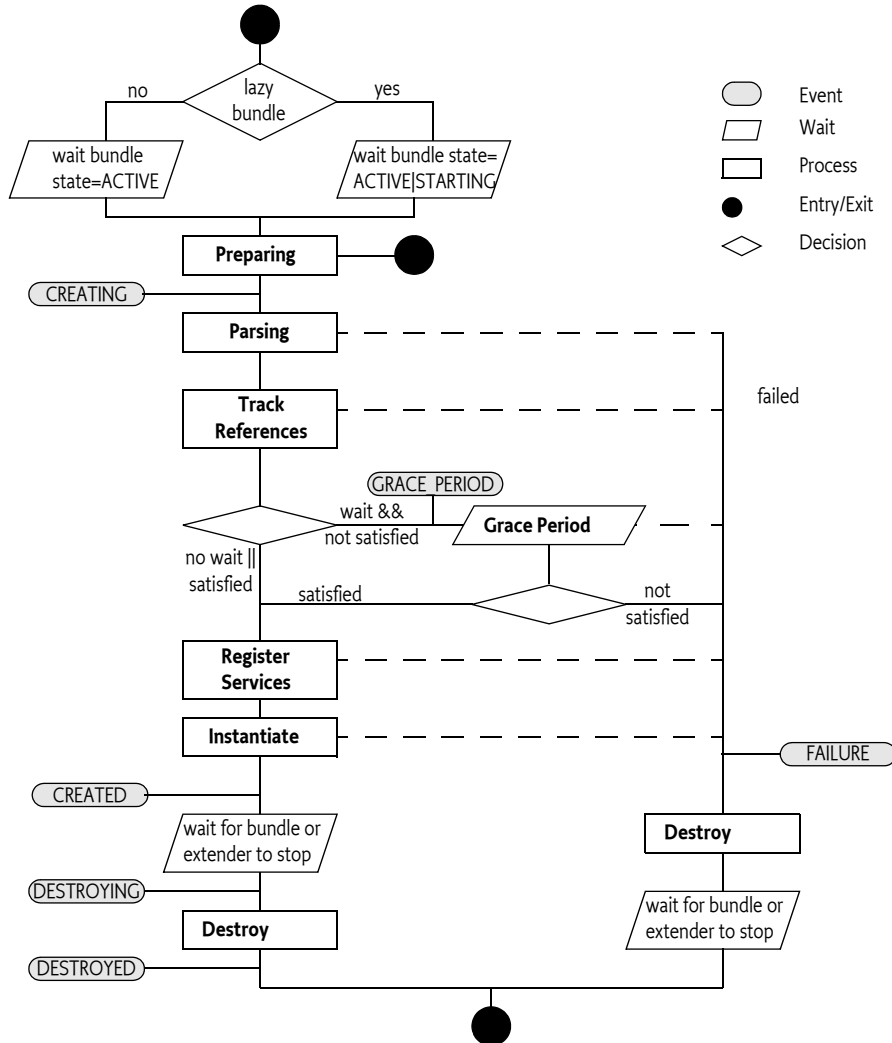

### 121.3.3 Extensions

A compliant implementation of this specification must follow the rules as outlined. However, implementations can provide functional extensions by including attributes or elements of other namespaces. For example, a Blueprint extender implementation that supports proxying of certain classes and a number of additional type converters could include a `http://www.acme.com/extensions` namespace that adds an `extensions` attribute on the blueprint element:

```
<?xml version="1.0" encoding="UTF-8"?>
<blueprint
  xmlns="http://www.osgi.org/xmlns/blueprint/v1.0.0"
  xmlns:ext="http://www.acme.com/extensions"

  ext:extensions="proxyClasses"
>
  ...
</blueprint>
```

Blueprint extenders that detect the use of an unrecognized namespace must fail to signal a portability problem.

### 121.3.4 Preparing

Blueprint definitions are stored as resources in the Blueprint bundle. If a Bundle-Blueprint manifest header is defined, then this header contains a list of paths. The Bundle-Blueprint header has the following syntax:

```
Bundle-Blueprint ::= header
                    // See Common Header Syntax in Core
```

This specification does not define any attributes or directives for this header. Implementations can provide proprietary parameters that should be registered with the OSGi Alliance to prevent name collisions. The non-localized version of the header must be used.

The last component of each path in the Bundle-Blueprint header may use wildcards so that `Bundle.findEntries` can be used to locate the XML document within the bundle and its fragments. The `findEntries` method must always be used in the non-recursive mode. Valid paths in the header have one of the following forms:

- *absolute path* - The path to a resource in the fragment or directory, this resource must exist. For example `cnf/start.xml`.
- *directory* - The path to directory in a fragment or main bundle, the path must end in a solidus (`' \u002F`). The pattern used in the `findEntries` method must then be `*.xml`. The directory is allowed to be empty.
- *pattern* - The last component of the path specifies a filename with optional wildcards. The part before is the path of directory in the bundle or one of its fragments. These two parts specify the parameter to `findEntries`. It is allowed to have no matching resources. An example of a pattern is: `cnf/*.xml`.

If no resources can be found, then the Blueprint bundle will not be managed and the initialization exits.

For example, the following header will read the resources `/lib/account.xml`, `/security.bp`, and all resources which path ends in `.xml` in the `/cnf` directory:

```
Bundle-Blueprint: lib/account.xml, security.bp, cnf/*.xml
```

If the Bundle-Blueprint header is not defined, then its default value is:

```
OSGI-INF/blueprint/*.xml
```

A Bundle-Blueprint manifest header specified in a fragment is ignored by the Blueprint Container. However, XML documents referenced by a bundle's Bundle-Blueprint manifest header, or its default, may be contained in attached fragments, as defined by the `findEntries` method.

If the Bundle-Blueprint header is specified but empty, then the Blueprint bundle must not be managed. This can be used to temporarily disable a Blueprint bundle.

### 121.3.5 Parsing

The Blueprint Container must parse the XML definitions into the Blueprint Container's metadata registry. Parsing fails if:

- A path from the Bundle-Blueprint header cannot be found in the bundle or any of its fragments.
- An XML definition does not validate against its schema.
- The XML elements do not meet one or more of their constraints
- Any errors occur

For failure, see *Failure* on page 659.

### 121.3.6 Tracking References

Service reference managers must track the service registry to see if they are satisfied or not. These managers must not be activated to register these service listeners nor must they activate any dependencies until they are activated. That is, no component instances for the reference listeners are obtained until the service reference manager is activated.

### 121.3.7 Grace Period

A Blueprint Container by default will wait for its dependencies in the *grace period*. However, this can be overridden with a directive on the Bundle-SymbolicName header of the Blueprint bundle:

- `blueprint.graceperiod (true|false)` - If set to true, then the Blueprint Container must enter the grace period and wait for dependencies, this is the default. Otherwise, it must skip the grace period and progress to the next phase regardless if there are any unsatisfied service references.

The purpose of the grace period is to handle the initialization of multiple bundles *gracefully*. The grace period will first wait a configurable time for all mandatory service references to become satisfied, or for the bundle to stop. If these mandatory services are satisfied, then the grace period succeeds, otherwise it will fail. If the bundle is stopped during the grace period, then the Blueprint Container must be destroyed.

During the waiting period services can come and go. Each time such a service event takes place that involves any of the mandatory service references, the Blueprint Container must send out another GRACE\_PERIOD event if that event does not result in ending the grace period. The event contains the complete filters of the unsatisfied service references, see *Blueprint Event* on page 700.

The wait time for the grace period is defined in a directive on the Bundle-SymbolicName header of the Blueprint bundle:

- `blueprint.timeout (Integer >= 0)` - The time to wait in the grace period for dependencies to become satisfied in milliseconds. The default is 300000, which is 5 minutes. If the timeout is 0, an indefinite wait will take place.

OSGi services are dynamic, therefore the grace period does not guarantee that all mandatory service references are still available. It only guarantees that at one moment in time they were available. A mandatory reference can become *unsatisfied* at any moment in time when a service is not available. See the *Service Dynamics* on page 696 for a description of how this is handled.

For example, the following header will make the bundle wait a maximum of 10 seconds for its mandatory service references to be satisfied. These dependencies must be satisfied, or a failure occurs.

```
Bundle-SymbolicName: com.acme.foo;  
    blueprint.graceperiod:=true;  
    blueprint.timeout:= 10000
```

### 121.3.8 Service Registration

A service manager must first activate all its explicit dependencies but it must not activate. It must then ensure that a Service Factory object is registered as a service when that service is *enabled*. Enabled means that all of the mandatory service references in its dependencies are satisfied.

Once the Service Factory is registered, any bundle can get the corresponding service object. Such a request must activate the service manager, if it is not already activated. Activation of a service manager must obtain a component instance from the Blueprint Container for the service object and any registration listeners. The registration listeners are then actuated and notified of the initial state.

### 121.3.9 Eager Instantiation

After all initialization is done, the Blueprint Container is ready. It is now possible to request component instances. If a bundle needs immediate startup because they cannot wait until they are triggered, then it should set the activation of its bean managers to *eager*. The Blueprint Container must request all eager managers to provide a component instance in this instantiation phase, see also *Lazy and Eager* on page 663.

### 121.3.10 Runtime Phase

The Blueprint Container must be registered as a service with the following service properties:

- `osgi.blueprint.container.symbolicname` - The bundle symbolic name of the Blueprint bundle
- `osgi.blueprint.container.version` - The version of the Blueprint bundle

The Blueprint Container service must only be available during the runtime phase when initialization has succeeded.

As long as the Blueprint extender and the Blueprint bundle are active, the application is in the runtime phase. The component instances perform their requested functionality in collaboration. The Blueprint Container can be used to provide objects from the defined managers, get information about the configuration, and general state information, see *Blueprint Container* on page 698.

### 121.3.11 Destroy the Blueprint Container

The Blueprint Container must be destroyed when any of the following conditions becomes true:

- The Blueprint bundle is stopped, that is, it is no longer ready.
- The Blueprint extender is stopped
- One of the initialization phases failed.

Destroying the Blueprint Container must occur synchronously with the Bundle STOPPING event if that caused any of the previous conditions. For example, if the Blueprint extender is stopped, it must synchronously destroy all Blueprint Containers it has created.

Destroying the Blueprint Container means:

1. Unregistering the Blueprint Container service
2. Deactivating all managers.
3. Destroying all component instances in reverse dependency order, see *Reverse Dependency Order* on page 650.

A Blueprint Container must continue to follow the destruction even when component instances throw exceptions or other problems occur. These errors should be logged.

If the Blueprint extender is stopped, then all its active Blueprint Containers must be destroyed in an orderly fashion, synchronously with the stopping of the Blueprint extender bundle. Blueprint Containers must use the following algorithm to destroy multiple Blueprint Containers:

1. Destroy Blueprint Containers that do not have any services registered that are in use by other bundles. More recently installed bundles must be destroyed before later installed bundles, that is, reverse bundle id order.
2. The previous step can have released services, therefore, repeat step 1 until no more Blueprint Containers can be destroyed.
3. If there are still Blueprint Containers that are not destroyed, then destroy the Blueprint Container with:
  - The registered service that is in use with the lowest ranking number, or if a tie
  - The highest registered service id

If there are still Bundle Containers to be destroyed, retry step 1

During the shutting down of an OSGi framework, it is likely that many bundles are stopped near simultaneously. The Blueprint extender should be able to handle this case, without deadlock, when the stop of a Blueprint bundle overlaps with the stop of the Blueprint extender bundle.

### 121.3.12 Failure

If a failure occurs during the initialization of the Blueprint bundle, then first a FAILURE event must be posted, see *Events* on page 699. Then the Blueprint Container should be destroyed, ensuring that no uninitialized or half initialized objects are destroyed. Failures should be logged if a Log Service is present.

### 121.3.13 Lazy

The Blueprint Container specification specifically allows lazy initialization of the application in the Blueprint bundle. No component instances are created until an eager manager is activated, or a service request comes in.

If no eager managers are defined and no service has explicit dependencies, then no component instances are provided until an external trigger occurs. This trigger can be a service request or a call to the `getComponentInstance` method of the Blueprint Container, which is registered as a service. This allows a Blueprint bundle to not create component instances, and thereby load classes, until they are really needed. This can significantly reduce startup time.

Some features of the component definitions can only be verified by inspecting a class. This class loading can break the lazy initialization of a Blueprint bundle. It is therefore allowed to delay this kind of verification until the activation of a manager.

This lazy behavior is independent of the bundle's lazy activation policy. Though the Blueprint extender recognizes this policy to detect when the bundle is ready (for a lazy activated bundle the STARTING state is like the ACTIVE state), it is further ignored. That is, the relation between a Bundle Activator that is lazily activated and the Blueprint Container is not defined.

## 121.4 Blueprint Definitions

The Blueprint XML resources in a bundle are the *definitions*. Each definition can include multiple namespaces. Implementations of the Blueprint core namespace must strictly follow this specification, if they add additional behavior they must add additional namespaces that are actually used in the definitions to signal the deviation from this specification.

The namespace for the core Blueprint definition resources is:

```
http://www.osgi.org/xmlns/blueprint/v1.0.0
```

Blueprint resources that use this core specification must have as top the blueprint element. The following example shows the body of a Blueprint definition:

```
<?xml version="1.0" encoding="UTF-8"?>
<blueprint
  xmlns="http://www.osgi.org/xmlns/blueprint/v1.0.0">
  ...
</blueprint>
```

The recommended prefix for the Blueprint core namespace is bp.

All elements in the Blueprint namespace are prepared for future extensions and provide a description child element in most positions.

**121.4.1 XML**

In the following sections, the XML is explained using the normal syntax notation used for headers. There is, however, one addition to the normal usage specific to XML, and that is the use of the angled brackets (<>). A term enclosed in angled brackets, indicates the use of a real element. Without the angled brackets it is the definition of a term that is expanded later to a one or more other terms or elements. For example:

```
people    ::= <person> *
person    ::= <child>* address
address   ::= <fr> | <us> | <nl>
```

Describes for example the following XML:

```
<people>
  <person id="mieke">
    <child name="mischa"/>
    <child name="thomas"/>
    <fr zip="34160"/>
  </person>
</people>
```

Attributes are described in tables that define how they map to their corresponding Metadata. As a rule, the XML elements and attributes are expressed directly in the Metadata.

The text in the following sections is a normative description of the semantics of the schema. However, the structure information is illustrative. For example, all description elements have been ignored for brevity. The exact structure is described by the XML schema, see *Blueprint XML Schema* on page 704.

There are a number of convenient XML types used in the following sections. These schema types are defined here:

- `qname` - A fully qualified Java class name in dotted form, for example `java.lang.String`.
- `method` - A valid Java method name, for example `setFoo`.
- `NCName` - A string syntax for names defined in [8] *XML Schema*.
- `ID` - A string syntax for ids defined in [8] *XML Schema*.
- `type` - A name of a Java type including arrays, see the next section *Syntax for Java types* on page 660.
- `target` - An inline bean, reference, or ref, see *Target* on page 663.
- `object` - An object value, see *Object Values* on page 683

In several cases, the actual syntax depends on the type conversion. This type of syntax is indicated with `<<type>>` indicates that the syntax of the string depends on the type conversion, where `ten` type is usually given as a parameter on the same Metadata.

**121.4.2 Syntax for java types**

A number of elements can refer to a Java type, for example the value element has a type attribute and a map element has a key-type attribute. The syntax for these types is as follows:

```
type     ::= qname array
array    ::= '[' *
```

Where `qname` is the fully qualified name of a Java class or interface, or the name of a primitive type.

For example:

```
<value type="java.lang.String[]"/>
```



It is not possible to specify generic information in this syntax.

### 121.4.3 XML and Metadata

The Blueprint Container parses the XML into Metadata objects, see *Metadata* on page 703. During parsing, the XML parser validates against the detailed Blueprint schema and will therefore catch many errors. However, the XML schema and the Metadata type are not equivalent. The XML contains many conveniences that the Blueprint Container must convert to the canonical type in the Metadata. A number of general rules apply for this conversion:

- An absent attribute will result in null, unless the schema element provides a default value. In that case, the default must be returned from the Metadata object. That is, a default is indistinguishable from a specifically set value.
- Defaults from the blueprint element are filled in the Metadata objects, they are not available in any other way.
- Strings are trimmed from extraneous whitespace, as described in XML normalization.
- Child elements are represented by List objects, in the order of their definition. If no child elements are specified, the list will be empty.

For example, the activation feature reflects the total of default-activation and activation attributes but does not reflect that a prototype scope always makes a bean lazy. That is, even if activation is eager, the bean must still have lazy activation when it has prototype scope.

### 121.4.4 <blueprint>

The blueprint element is the top element. The definitions consist of two sections: the type-convert-section and the managers section.

```

blueprint      ::= <type-converters>manager*
manager       ::= <bean> | <service>
                | service-reference
service-reference ::= <reference> | <reference-list>
type-converters ::= <bean> | <ref>
  
```

In this specification, the reference and reference-list managers are referred to as *service references* when their differences are irrelevant. The blueprint element structure is visualized in Figure 121.6.

Figure 121.6 Managers (*bold = element name, plain=base type*)

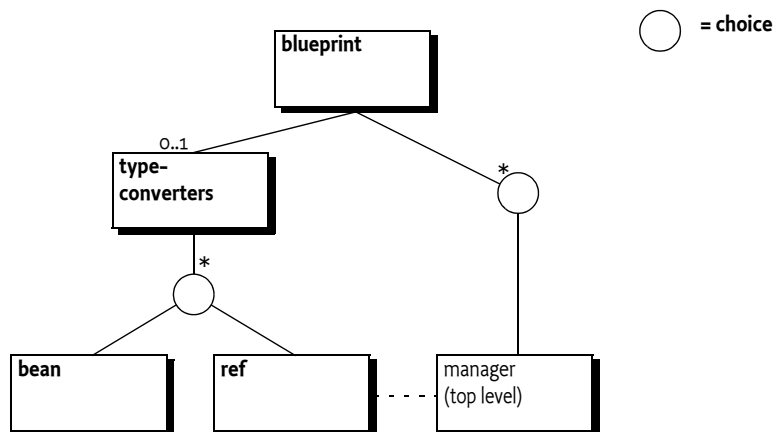

### 121.4.5 Metadata

The blueprint element has no corresponding Metadata class.

### 121.4.6 Defaults

The blueprint element supports the setting of the diverse defaults for the current definition resource with the following attributes:

- `default-activation` - Controls the default for the activation attribute on a manager. See *Lazy and Eager* on page 663. The default for this attribute is `eager`.
- `default-availability` - The default availability of the service reference elements, see *Service Reference Managers* on page 676. The default for this attribute is `mandatory`.
- `default-timeout` - The default for the reference element timeout attribute, see *Service Reference Managers* on page 676. The default for this attribute is 30000, or 5 minutes.

These defaults are specific for one definition resource, they apply only to elements enclosed to any depth in the blueprint element. These defaults are not visible in the Metadata.

### 121.4.7 <type-converters>

The Blueprint definitions are text based but the component instances require actual classes for their construction and dependency injection. Component instances are injected with general objects the target type is not always compatible with the source type. This specification therefore allows for *type conversion*. Type conversion rules are specified in *Type Conversion* on page 691. This section provides beans, or referrals to beans, that can be used in this type conversion process. They are listed in a separate section so they can be registered as a type converter, pre-instantiated, and preventing dependencies that easily become cyclic. Beans defined in the `type-converters` element must be registered as top-level managers.

The structure of the `type-converters` element is:

```
type-converters ::= ( <bean> | <ref> )*
```

Type converters defined with the `ref` element can refer to bean managers or reference managers. Type converters must have ids distinct from any other manager and are available through the Blueprint Container's `getComponentInstance` method.

### 121.4.8 manager

The component XML schema type is the base type of the bean, service, reference-list, and reference elements. All manager sub-types share the following attributes:

- `id` - The manager and its Metadata are identified by its `id` as defined in its Component Definition. In general this `id` is therefore referred to as the *component id*. This is an optional attribute. If it is not defined, a default calculated unique `id` will be assigned to it for top-level managers. For in-lined managers, the `id` attribute cannot be set, their Metadata must return null. All top level manager `ids` must be unique in a Blueprint Container.

The `id` attribute must be of type ID as defined in XML Schema, see [8] *XML Schema*. The syntax for an `id` is therefore:

```
id ::= ID // See ID in [8] XML Schema
```

Ids generally use camel case, like `myComponent`, and they are case sensitive. That is, component `id` `madHatter` and `madhatter` are distinct ids. Applications should not use ids starting with the prefix `blueprint`.

Ids are not required, if no component `id` is specified, the Blueprint Container must assign a unique `id` when it is a configured in a top level element. This calculated `id` must start with a full stop ('`\u002E`).

- `activation` - Defines the activation mode to be `lazy` or `eager`. See *Eager Instantiation* on page 658.

- `dependsOn` - The list of explicit dependencies that must be activated. See *Explicit Dependencies* on page 663.

The Metadata interface of top level managers will be a sub-interface of `ComponentMetadata` and is available from the Blueprint Container by its component id.

Figure 121.7 Inheritance hierarchy for managers

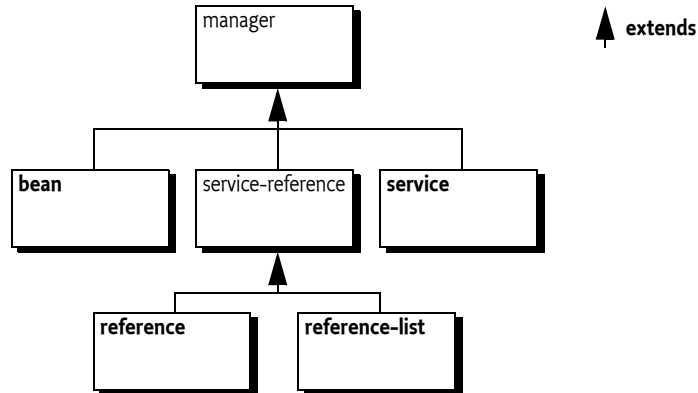

#### 121.4.9 Explicit Dependencies

The `dependsOn` list contains the ids of the top-level managers the bean explicitly depends on. Unless stated otherwise in the specific manager description, explicit dependencies must be activated before their manager is activated.

For example:

```
<bean id="alice" class="com.acme.MadHatter"
      depends-on="cheshire rabbit queen" />
```

This example will ask the top level managers `cheshire`, `rabbit`, and `queen` to provide an object before `alice` is activated. For a discussion about dependencies see *Manager Dependencies* on page 649.

#### 121.4.10 Lazy and Eager

During initialization, all *eager* top level managers are requested to provide a component instance. Applications can use this request as an indication to start providing their intended functionality.

Managers that are *lazy*, that is, not singleton scope, activation is lazy, or inlined, are activated when they are first asked to provide a component instance. Therefore, even lazy managers can activate during initialization when they happen to be a dependency of another manager that activates its dependencies.

Services and service references can also have lazy or eager activation. The *eager* activation will ensure that all listeners are properly actuated during the corresponding activation. For services, the service object is then also requested at startup.

The following example defines an eager bean by making it a singleton and setting the activation to *eager*:

```
<bean id="eager" scope="singleton"
      class="com.acme.FooImpl" activation="eager" />
```

#### 121.4.11 Target

In several places in the Blueprint schema it is necessary to refer to a *target*. A target is a:

- ref - Must reference one of the following managers
- reference - An inlined reference manager
- bean - An inlined bean manager

The target type is normally used for listeners, service objects, and other places where a general application component instance is required.

## 121.5 Bean Manager

A bean manager provides an arbitrary Java object. It constructs this object from a given class or factory and then configures the object by injecting its *properties* with other component instances or more general object values.

The provided component instance can be a singleton or a new object can be returned on every invocation (prototype), this behavior is defined with the scope attribute, see *Scope* on page 667.

The provided object can optionally be notified when all of its properties have been injected, and when the providing bean manager will be deactivated, see *Life Cycle Callbacks* on page 669.

### 121.5.1 Bean Component XML

The structure of a bean element is:

```
bean ::= ( <argument> | <property>)*
```

Figure 121.8 Bean Structure

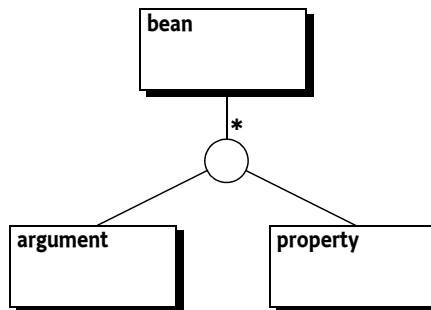

### 121.5.2 <bean>

The Metadata for a bean manager is represented in the BeanMetadata interface, which extends ComponentMetadata. Table 121.1 provides an overview of the related XML definitions and the BeanMetadata interface. The table only provides a summary, the sometimes subtle interactions between the different features are discussed in later sections.

Table 121.1 Bean Manager Features

Attribute or Element	Syntax	Bean Metadata	Description
id	ID	id : String	The id of a top level manager, must be unique in the Blueprint Container. All inlined managers must return null for their id.

Attribute or Element	Syntax	Bean Metadata	Description
activation	lazy   eager	activation : int	Defines if this bean is lazily or eagerly activated. If not explicitly set, the blueprint element's value for the default-activation attributes is used. If this is also not set, the value is eager. See <i>Lazy and Eager</i> on page 663.
depends-on	NCName*	dependsOn : List<String>	Explicit list of ids that are the dependencies. These referred managers must be activated before this bean can provide an object. See <i>Explicit Dependencies</i> on page 663. This is a white-space separated list.
class	qname	className : String	Class name of the object to be provided or the class name for a static factory. See <i>Construction</i> on page 668.
scope	singleton   prototype	scope : String	The scope defines the construction strategy for the component instance. The default is singleton except for inlined bean managers, where it is prototype. There is no schema default, so if it is not explicitly set, the Metadata will be null. See <i>Scope</i> on page 667.
init-method	method	initMethod : String	The name of a method to invoke when a provided object has been injected with all its properties. If this is not set, it is null. See <i>Life Cycle Callbacks</i> on page 669.
destroy-method	method	destroyMethod : String	A name of a method to invoke on the provided objects with singleton scope when the Blueprint Container is destroyed. If this is not set, it is null. See <i>Life Cycle Callbacks</i> on page 669.
factory-method	method	factoryMethod : String	The name of the method on a static or component instance factory. See <i>Construction</i> on page 668.
factory-ref	NCName	factoryComponent : String	A reference to a manager that acts as the factory. See <i>Construction</i> on page 668.

Attribute or Element	Syntax	Bean Metadata	Description
<argument>	Table	arguments : List<BeanArgument>	Defined as sub-elements of the bean element. A BeanArgument object contains the value of an argument in the factory method or constructor. The order of the arguments is declaration order. See <i>Construction</i> on page 668.
<property>	Table	properties : List<BeanProperties>	Defined as sub-elements of the bean element. A BeanProperty object provides the property name and injection value. See <i>Properties</i> on page 668.

The bean element has the following constraints that are not enforced by the schema but must be enforced by the Blueprint Container:

- The `destroyMethod` must not be set when the scope is `prototype`.
- The `activation` must not be set to `eager` if the bean also has `prototype` scope.
- The following combinations of arguments are valid, all other combinations are invalid:
  - `className`
  - `className, factory-method`
  - `factory-ref, factory-method`

### 121.5.3

#### <argument>

The argument element holds a value for a constructor or factory method's parameters.

Table 121.2

*Bean Argument Features*

Attribute or Element	Syntax	Bean Argument	Description
index	int >= 0	index : int	The index of the argument in the constructor or factory-method signature. If this is not set, the Blueprint Container must use the type information to calculate it to match the disambiguation algorithm. The index will be -1 when not explicitly set.
type	qname	valueType : String	The fully qualified class name of a Java type to match the argument to the signature against.
ref	NCName	value : RefMetadata	A reference to a top level manager that provides the value for the argument.
value	<<type>>	value : ValueMetadata	The Value Metadata based on the value property.
<...>	object	value : Metadata	An inlined value.

The argument element has the following additional constraints:

- Either all arguments have a specified index or none have a specified index.
- If indexes are specified, they must be unique and run from 0..(n-1), where n is the number of arguments.
- The following attributes and elements are mutually exclusive:
  - ref
  - value
  - An inlined object value

#### 121.5.4 <property>

The property element holds the information to inject a bean property with an object value.

Table 121.3 *Bean Property Features*

Attribute or Element	Syntax	Bean Property	Description
name	method ( '!' method )*	name : String	The property name, for example foo. The method name can consist of full stop separated method names, indicating nested property access.
ref	NCName	value : RefMetadata	A reference to a top level manager.
value	<<type>>	value : ValueMetadata	A Value Metadata where the type is null.
<...>	object	value : Metadata	An inlined object value.

The argument element has the following additional constraints:

- The following attributes/elements are mutually exclusive
  - ref
  - value
  - An inlined object value

#### 121.5.5 Scope

A bean manager has a recipe for the construction and injection of an object value. However, there can be different strategies in constructing its component instance, this strategy is reflected in the scope. The following scopes are architected for this specification:

- singleton - The bean manager only holds a single component instance. This object is created and set when the bean is activated. Subsequent requests must provide the same instance. Singleton is the default scope. It is usually used for core component instances as well as stateless services.
- prototype - The object is created and configured anew each time the bean is requested to provide a component instance, that is, every call to `getComponentInstance` must result in a new component instance. This is usually the only possible scope for stateful objects. All inlined beans are always prototype scope.

Implementations can provide additional scope types. However, these types must only be allowed when a defining namespace is included in the definitions and is actually used in the definitions to specify the dependency on this feature.

## 121.5.6 Construction

The Blueprint specification supports a number of ways for a bean manager to construct an object. Each possibility is a combination of the following Metadata properties:

- `className` - Defines the fully qualified name of a class to construct, or the name of a class with a static factory method. The class must be loadable from the Blueprint bundle `loadClass` method.
- `factoryMethod` - A static or instance factory method name that corresponds to a publicly accessible method on the given class or factory manager.
- `factoryComponent` - The id of a top-level target manager in the Blueprint Container that is an instance factory.

The Bean manager can have a number of `BeanArgument` objects that specify arguments for the constructor or for the factory class/object method. The matching constructor or method must be publicly accessible. The argument's `valueType` can be used to disambiguate between multiple signatures of constructors or methods. See *Signature Disambiguation* on page 689.

The value of the argument is always a `Metadata` object. Such an object can be converted into a general object value, see *Object Values* on page 683.

The construction properties can be used in a rather large number of combinations, however, not all combinations are valid. Table 121.4 shows the different valid combinations. If none of the combinations matches, then the Bean Metadata is erroneous.

In Table 121.4, a variation of the following bean definition is assumed:

```
<bean class="C" factory-method="f" factory-ref="fc">
  <argument value="1"/>
  <argument value="2"/>
</bean>
```

This definition is invalid because it specifies an invalid combination of metadata properties. The only valid combinations are subsets, they are all specified in the following table.

Table 121.4

*Component Attributes and Construction*

<code>className</code>	<code>factory-method</code>	<code>factory-ref</code>	<code>argument</code>	Corresponding Java Code
C				<code>new C</code>
C	f			<code>C.f()</code>
C			1,2	<code>new C(1,2)</code>
C	f		1,2	<code>C.f(1,2)</code>
	f	\$fc		<code>\$fc.f()</code>
	f	\$fc	1,2	<code>\$fc.f(1,2)</code>
*	*	*	*	failure

The object created this way will be the provided object of the bean after any properties are injected. If the `factoryMethod` returns a primitive type, then this primitive must be converted to the corresponding wrapper type before any usage.

## 121.5.7 Properties

Dependency injection configures a constructed object with the help of the properties, which is a List of `BeanProperty` objects. A `BeanProperty` has the following features:

- `name` - The name of the bean property. This name refers to the set method on the constructed object as specified in the design pattern for beans getters and setters, see [5] *Java Beans Specification*. For example, if the property name is `foo`, then the public method `setFoo(arg)` will be used to set the value. There should only be one set method with a single argument for a specific property. If overloaded properties are encountered, the chosen set method is unspecified.



Nested property names are allowed when setting bean properties, as long as all parts of the path, except the property that is set, result in a non-null value. The parts of the path are separated with a full stop (' \u002E). For example:

```
<property name="foo.bar.baz" value="42"/>
```

This example gets the foo property, from the constructed object, it then gets the bar property and then sets the baz property on that object with the given value.

- value - The value of the property is always a Metadata object. This Metadata object can be converted to a value object, see *Object Values* on page 683.

After the Metadata object is converted to an object value, it must be injected into the property. If the value object is not directly assignable to the property type (as defined by its only set method and the rules in *Type Compatibility* on page 690), then the Blueprint Container must use the type conversion mechanism to create a new object that matches the desired type, or fail. See *Dependency Injection* on page 689 for more information about dependency injection.

For example, the following bean creates an instance and then injects a three into a the foo property that it gets from the bar property. The string that holds the three is converted to a double:

```
<bean id="foo" class="com.acme.Foo">
  <property name="bar.foo" value="3"/>
</bean>
```

```
// Classes
package com.acme;
public class Bar {
    double v;
    public void setFoo(double v) { this.v = v; }
}
public class Foo {
    Bar bar = new Bar();
    public void getBar() { return bar; }
}
```

```
// Corresponding Java code
Foo foo = new Foo();
foo.getBar().setFoo(3.0);
```

## 121.5.8 Life Cycle Callbacks

The bean element provides two attributes that define the *callback* method names for initialization and destruction. A callback must be implemented as a publicly accessible method without any arguments. The callback method names must exist as void() methods.

The `initMethod` specifies the name of an initialization method that is called after all properties have been injected. The `destroyMethod` specifies the name of a destroy method that is called when the Blueprint Container has destroyed a component instance. Only bean managers with singleton scope support the `destroyMethod`. The destroy callback cannot be used for beans that have prototype scope, the responsibility for destroying those instances lies with the application.

## 121.5.9 Activation and Deactivation

A singleton bean manager must construct its single object during activation and then callback its `initMethod` method. Prototype scoped beans are created after activation and also have their `initMethod` invoked. The destroy method is called during the destruction of all the beans in singleton scope, this happens after deactivation.

A prototype bean manager has no special activities for deactivation.

## 121.6 Service Manager

The service manager defined by a service element is responsible for registering a service object with the service registry. It must ensure that this service is only registered when it is *enabled*. Where enabled means that all its mandatory service reference managers in its dependencies are satisfied.

### 121.6.1 <service>

The XML structure of the <service> manager is:

```

service                ::= <interfaces>
                        <service-properties>
                        <registration-listener>*
                        target
interfaces             ::= <value>+
service-properties    ::= <entry>+
registration-listener ::= target

```

The service manager has the features outlined in Table 121.5 on page 670. The following additional constraints apply:

- The interface attribute and interfaces element are mutually exclusive.
- If the auto-export attribute is set to anything else but disabled, neither the interface attribute nor the interfaces element must be used.
- The ref attribute and inlined element are mutually exclusive

Table 121.5 Service Manager Features

Attribute or Element	Type	Service Metadata	Description
id	ID	id : String	Optional component id of the manager, if it is a top level manager.
activation	lazy   eager	activation : int	Defines if this service is lazily or eagerly initialized. If not explicitly set, the blueprint element's value for the default-activation attributes is used. If this is also not set, the value is eager. See also <i>Lazy and Eager</i> on page 663.
depends-on	NCName*	dependsOn : List<String>	Explicit list of ids that are the dependencies. These managers must be activated at the start of the registration phase. See <i>Explicit Dependencies</i> on page 663. This is a whitespace separated list.
interface	qname	interfaces : List<String>	Name of the interface under which this service should be registered. See <i>Service Interfaces</i> on page 672.

Attribute or Element	Type	Service Metadata	Description
auto-export	disabled   interfaces   class- hierarchy   all-classes	autoExport : int	Defines the way the class must be analyzed to find the interfaces under which the service must be registered. The schema default is disabled. See <i>Service Interfaces</i> on page 672
ranking	int	ranking : int	The service.ranking value. The schema default is 0, which implies no service property. See <i>Ranking</i> on page 674.
ref	NCName	value : RefMetadata	Reference to the manager that provides the service object. See <i>Service Object</i> on page 674.
<service-properties>	See <map> on page 686.	serviceProperties : List<MapEntry>	The service properties for this service. See <i>Service Properties</i> on page 673.
<registration-listener>	See Table 121.6.	registrationListeners : List<Registration Listener>	The registration listeners. See <i>Registration Listener</i> on page 674.
<interfaces>	<value>*	interfaces : List<String>	Names of interfaces under which this service should be registered. Each interface name must be listed as a child value element. This value element has no attributes. For example:  <pre>&lt;interfaces&gt;   &lt;value&gt;com. a. Foo&lt;/value&gt;   &lt;value&gt;com. a. Bar&lt;/value&gt; &lt;/interfaces&gt;</pre>
<...>	target	value : Target	The value element must only hold a string value. See <i>Service Interfaces</i> on page 672 An inlined target manager that is used for the service object. See <i>Service Object</i> on page 674

### 121.6.2 <registration-listener>

The service element can contain zero or more registration-listener elements, that define registration listeners to be notified of service registration and unregistration events. This element has the following structure:

```
registration-listener ::= target*
```

The registration-listener element defines the callback methods for registration and unregistration.

Table 121.6 *Registration Listener Features*

Attribute or Element	Type	Registration Listener	Description
ref	NCName	registrationListener : Target	A reference to a top level manager.

Attribute or Element	Type	Registration Listener	Description
registration-method	method	registrationMethod : String	The name of the method to call after the service has been registered. See <i>Registration Listener</i> on page 674.
unregistration-method	method	unregistrationMethod : String	The name of the method to call before the service will be unregistered. See <i>Registration Listener</i> on page 674.
<...>	target	registrationListener : Target	An inlined target manager

The additional constraint is:

- The ref attribute and the inlined manager are mutually exclusive.
- Either or both of the registrationMethod and unregistrationMethod must be set.
- For each method name set, there must be at least one method matching the possible prototypes in the registration listener object, see *Registration Listener* on page 674.

### 121.6.3 Explicit Dependencies

A service manager must initialize any explicit dependencies in the start of its registration phase, even before it tracks its enabled state. The presence of explicit dependencies will not activate the service manager.

### 121.6.4 Provided Object

A service manager provides a proxy to a ServiceRegistration object. If this proxy is used when the dependencies are not met, and the service is therefore unregistered, an Illegal State Exception must be thrown. In all other cases, the proxy acts as if it was the ServiceRegistration object associated with the registration of its service object.

The unregister method on the returned object must not be used. If the application code calls unregister then this must result in an UnsupportedOperationException.

### 121.6.5 Service Interfaces

Each service object is registered under one or more interface names. The list of interface names is provided by interfaces or autoExport.

The autoExport tells the Blueprint Container to calculate the interface(s) from the type of the service object. The autoExport can have the following values:

- disabled - No auto-detection of service interface names is undertaken, the interface names must be found in interfaces. This is the default mode.
- interfaces - The service object will be registered using all of its implemented public Java interface types, including any interfaces implemented by super classes.
- class-hierarchy - The service object will be registered using its actual type and any public super-types up to the Object class (not included).
- all-classes - The service object will be registered using its actual type, all public super-types up to the Object class (not including), as well as all public interfaces implemented by the service object and any of its super classes.

The autoExport requires the actual class object for introspection for all its modes except disabled, which can cause a bundle with a lazy activation policy to activate because a class will be loaded from the Blueprint bundle.

As an example:

```
<bean id="fooImpl" class="FooImpl"/>
```

```
public class FooImpl implements Foo { ... }
```

Then the following service definitions are equivalent:

```
<service id="foo">
  <interfaces>
    <value>com.acme.Foo</value>
  </interface>
</service>
<service id="foo" interface="com.acme.Foo" ref="fooImpl"/>
<service id="foo" auto-export="interfaces" ref="fooImpl"/>
```

## 121.6.6 Service Properties

Each service can optionally be registered with *service properties*. The `serviceProperties` is a list of `MapEntry`, see `<entry>` on page 687. This metadata must be used to create the service properties. Service properties creation can have side effects because they can use component instances. The service properties must therefore be created once before the first time the service is registered.

The service manager adds the following automatic service properties that cannot be overridden. When these properties are explicitly set, they must be ignored.

- `osgi.service.blueprint.compname` - This will reflect the id of the manager that provides the service object, unless it is inlined. Inlined beans are always anonymous and must not have this property set.
- `service.ranking` - If the ranking attribute is not zero, this property will be set and hold an `Integer` object with the given value, see *Ranking* on page 674.

For example, the following definition is followed by equivalent Java code needed to register the service:

```
<service ref="fooImpl" interface="com.acme.Foo">
  <service-properties>
    <entry key="size" value="42"/>
  </service-properties>
</service>
```

```
Dictionary d = new Hashtable();
d.put("size", "42");
d.put("osgi.service.blueprint.compname", "fooImpl");
ServiceRegistration sr =
    bundleContext.registerService("com.acme.Foo",
        blueprintContainer.getComponentInstance("fooImpl"),
        d);
```

Service properties should specify the `valueType` of the entry unless the value to be registered needs to be a `String` object. The service property types should be one of:

- *Primitives Number* - `int`, `long`, `float`, `double`, `byte`, `short`, `char`, `boolean`
- *Scalar* - `String`, `Integer`, `Long`, `Float`, `Double`, `Byte`, `Short`, `Character`, `Boolean`.
- *Array* - An array of either the allowable primitive or scalar types.
- *Collection* - An object implementing the `Collection` interface that contains scalar types.

See `<entry>` on page 687 types for information how to create these types.

### 121.6.7 Service Object

The service manager must not request the Blueprint Container for the service object until it is actually needed because a bundle requests it. The service object is represented in the value. This is a Metadata object that can be used to construct an object value, see *Object Values* on page 683.

For example:

```
<service id="fooService" ref="fooImpl" ... />

<service id="fooService" ... >
  <bean class="com.acme.fooImpl" />
</service>
```

The scope of the beans is ignored for the manager that provides the service object. Its value will only be created once the first time it is needed for the service.

### 121.6.8 Scope

A service manager must always register a Service Factory as service object and then dispatch the service requests to the service object. A service manager must obtain a single component instance as service object. This component instance is shared between all bundles. That is, even if the service object comes from a prototype scoped manager, only one instance is ever created per service manager.

If this component instance implements Service Factory, then all incoming service requests are forwarded to this single component instance.

### 121.6.9 Ranking

When registering a service with the service registry, an optional *service ranking* can be specified that orders service references. The service ranking is registered as the `SERVICE_RANKING` property defined in the OSGi service layer. When a bundle looks up a service in the service registry, given two or more matching services, then the one with the highest number will be returned. The default ranking value for the OSGi service registry is zero, therefore, this property must not be registered when ranking is zero, which is also the default value.

For example:

```
<service ref="fooImpl" interface="com.acme.FooImpl"
  ranking="900" />
```

This will result in the following service property:

```
service.ranking=new Integer(900)
```

### 121.6.10 Registration Listener

The registrationListeners represent the objects that need to be called back after the service has been registered and just before it will be unregistered.

The listenerComponent must be a Target object; it is the target for the following callbacks:

- `registrationMethod` - The name of the notification method that is called after this service has been registered.
- `unregistrationMethod` - This method is called when this service will be unregistered.

The signatures for the callback methods depend on the scope and if the service object implements the ServiceFactory interface. The different possibilities are outlined in the following table.

Table 121.7 *Interaction scopes and types for callback signature.*

Scope	Type	Signature	Comment
singleton	ServiceFactory	void(ServiceFactory,Map)	All service requests are handled by the component instance.
singleton	T	void( super T,Map)	T is assignable from the service object's type.
prototype	ServiceFactory	void(ServiceFactory,Map)	All service requests are handled by the first component instance.
prototype	T	void(,Map)	The first argument must be null because for prototype service objects, the component instance is created when a bundle requests the service. Therefore, at registration time there is no service object available.

If multiple signatures match, then all methods must be called in indeterminate order. At least one method must match.

The service manager must provide the registration listener with the current registration state when the listener is registered. This initial notification must take place before any other callback methods are called on this listener on other threads. That is, if the service is registered at that time, it must call the registration method and otherwise the unregistration method.

The following example shows two registration listeners, one with a referred bean and another one with an inlined bean.

```
<service ref="fooImpl" interface="com.acme.Foo">
  <registration-listener registration-method="reg"
    unregistration-method="unreg">
    <bean class="com.acme.FooListener"/>
  </registration-listener>
</service>

<service ref="fooImpl" interface="com.acme.Foo">
  <registration-listener registration-method="reg"
    unregistration-method="unreg" ref="fooListener"/>
</service>
<bean id="fooListener" class="com.acme.FooListener"/>

package com.acme;
public class FooListener {
  public void reg( Foo foo, Map properties ) { ... }
  public void unreg( Foo foo, Map properties ) { ... }
}
```

The manager that provides the registration listener object is an implicit dependency of the enclosing service manager. However, the registration listener component instance is specifically allowed to use to the service manager though this is technically a cyclic dependency. Therefore, a bean is allowed to be both be injected with a ServiceRegistration object from the service manager as well as being a registered listener to the same service manager.

In the following example, the foo service manager uses manager main, both as a registration listener as well as top-level bean main being injected with reference foo.

```

<service id="foo" interface="com.acme.Foo" ref="main">
  <registration-listener
    registration-method="register" ref="main"/>
</service>

<bean id="main" class="com.acme.Main" init-method="done">
  <property name="foo" ref="foo"/>
</bean>

```

### 121.6.11 Enabled

A service manager needs a service object that is referred to by the valueMetadata property. This value can in its turn depend on other managers transitively. If any of these managers are service reference managers, then they can be satisfied or not. If these service reference managers are marked to be mandatory, then they influence the *enabled* state of the first service manager. Only if all of these mandatory service reference managers in the dependency graph are satisfied, then the first service manager is enabled.

A service manager must have a Service Factory registered with the OSGi service registry after the primary initialization of the Blueprint Container has been done until the Blueprint Container is destroyed while it is enabled. See *Service Registration* on page 657.

### 121.6.12 Activation and Deactivation

When a service manager is activated, it must actuate its registration listeners. Each registration listener must be called back during its actuation with the current service registration state as described in the *Registration Listener* on page 674. Normally, this will also request the container for a service object but this can be further delayed in certain circumstances. See *Service Object* on page 674 for more details.

During deactivation, a service manager must disable any registration listeners and release any dependencies it has on these component instances.

## 121.7 Service Reference Managers

The reference, and reference-list elements are all *service references*. They select a number of services in the service registry. The structure of these elements is as follows:

```

reference      ::= <reference-listener>*
reference-list ::= <reference-listener>*

```

The inheritance hierarchy for service references is depicted in Figure 121.9 on page 676.

Figure 121.9 Inheritance hierarchy for service references

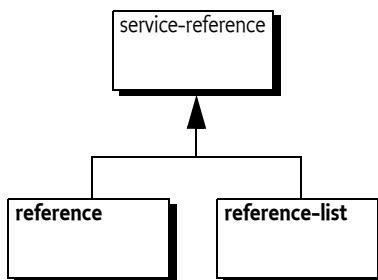



### 121.7.1 Service Reference

The service reference managers have almost identical Metadata and share most behavior. The only schema differences between a reference manager and a reference-list manager are:

- timeout - A reference manager supports a timeout.
- memberType - The reference-list can define its member-type

The features of the service references are explained in the following table.

Table 121.8 Service Reference Manager Features

Attribute or Element	Type	ServiceReference-Meta-data	Description
id	ID	id : String	The component id of a top level manager
activation	lazy   eager	activation : int	Defines if this service reference is lazily or eagerly initialized. If not explicitly set, the blueprint element's value for the default-activation attributes is used. If this is also not set, the value is eager. See also <i>Lazy and Eager</i> on page 663.
depends-on	NCName*	dependsOn : List<String>	Explicit list of component ids that are the dependencies. These managers must be activated before this service reference's activation. See <i>Explicit Dependencies</i> on page 663. This is a whitespace separated List.
availability	mandatory   optional	availability : int	Defines if a service reference is mandatory or optional. The default for the availability attribute is defined by the default-availability attribute in the blueprint element. If the default-availability attribute is not defined, the value is mandatory.
interface	qname	interface : String	A single name of an interface class. It is allowed to not specify an interface name.
component-name	NCName	componentName : String	Points to another manager in another Blueprint Container registered in the service registry. If set, the component name must be part of the effective filter.
filter	filter	filter : String	The given filter string, can be null.

Attribute or Element	Type	ServiceReference-Meta-data	Description
<reference-listener>	See <reference-listener> on page 678.	referenceListeners : List<Listener>	The Metadata of the reference listeners

The additional constraints for service references are:

- The interface, if set, must refer to a public interface.

### 121.7.2 <reference>

A reference manager, selecting a single service, has the additional feature explained in the following table.

Table 121.9 Reference Features

Attribute or Element	Type	Reference Metadata	Description
timeout	long >= 0	timeout : long	The timeout in ms. Zero is indefinite.

An additional constraint on the reference is:

- The timeout must be equal or larger than zero.

### 121.7.3 <reference-list>

A reference-list manager, selecting multiple services, has the additional feature explained in the following table.

Table 121.10 Reference-list Features

Attribute or Element	Type	Reference List Metadata	Description
member-type	service-object   service-reference	memberType : int	Defines if the members of the list are ServiceReference objects or the proxies to the actual service objects.

### 121.7.4 <reference-listener>

The reference element can notify reference listeners of the service selection changes with the referenceListeners. The reference-listener element has the following structure:

```
reference-listener ::= target*
```

The reference-listener element defines the callback methods for binding and unbinding a service.

Table 121.11 Reference Listener Features

Attribute or Element	Type	Reference Listener	Description
ref	NCName	listenerComponent : Target	A reference to a top level target manager.
bind-method	method	bindMethod : String	The name of the method to call after the service has been bound. See <i>Reference Listeners</i> on page 681.

Attribute or Element	Type	Reference Listener	Description
unbind-method	method	unbindMethod : String	The name of the method to call before the service will be unbound. See <i>Reference Listeners</i> on page 681.
<...>	target	listenerComponent : Target	An inlined target manager

The additional constraints are:

- The ref attribute and the inlined manager are mutually exclusive.
- Either or both bindMethod and unbindMethod must be specified.
- At least one specified method must exist with each given method name, see *Reference Listeners* on page 681.

### 121.7.5 Provided Object For a Reference

The provided object for a service reference manager is a *proxy* backed by a service object from the service registry. Therefore, even though the injected object will remain constant, it can change its reference to a backing service at any time, implying it can only be used with stateful services if reference listeners are used. If use when no suitable backing service is available, it will wait until it times out. See *Service Dynamics* on page 696 for more details. The model is depicted in Figure 121.10.

Figure 121.10 Constant references with dynamic selection

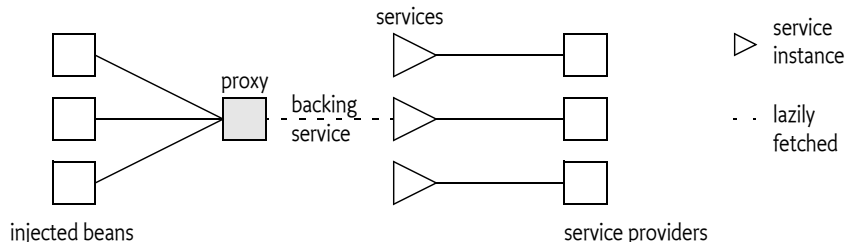

The following example shows how a property can be set to the service object.

```
public class C {
    public void setProxy(T ref) { ... }
}
<reference id="p" interface="T"/>
<bean id="c" class="C">
    <property name="proxy" ref="p"/>
</bean>
```

### 121.7.6 Provided Object For a Reference-list

The reference-list provided object implements the List interface; this List contains proxies to the backing services. These proxies do not have a timeout. That is, when a proxy from a reference-list is used, it must not wait when the backing service is no longer available but it must immediately throw a Service Unavailable Exception.

Changes to the list are dynamic. When a backing service is unregistered, the corresponding proxy is removed from the list synchronously with the service event. When a new service enters the selection, it is added synchronously with the service event. Proxies to newly discovered services must be added at the end of the list. The structure is depicted in Figure 121.11.

Figure 121.11 Constant reference to list with dynamic selection

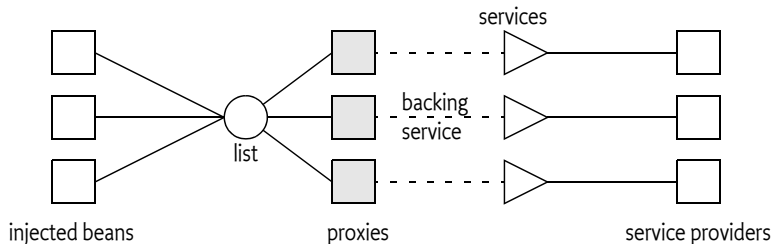

The member type of the list depends on the memberType. If this is set to:

- `service-object` - Inject a List of service objects, this is the default.
- `service-reference` - Inject a list of ServiceReference objects

If generics information is available, then it is an error if the generic member type of the target list is not assignable with the memberType. If the member target type is in itself specified with generic arguments, like `List<T<U>>`, then the assignment must fail because this would require conversion and no conversion can take place for this assignment. For information about generics, see *Generics* on page 695.

### 121.7.7 Read Only Lists

The list is a read-only view on the actual set of proxies to the service objects. This List object must only support the following methods:

```
contains(Object)
containsAll(Collection)
equals(Object)
get(int)
hashCode()
indexOf(Object)
isEmpty()
iterator() // no remove method
lastIndexOf(Object)
listIterator() // not supported
listIterator(int) // not supported
size()
subList(int, int) // same list type as parent
toArray()
toArray(T[])
```

All other methods must throw an `UnsupportedOperationException`. The `List Iterator` is not supported for these lists.

### 121.7.8 Selection

A service reference must provide a *selection* of services from the service registry. The Blueprint Container must logically use a filter for the selection that is the `and (&)` of the following assertions:

- The interface, if specified
- If `componentName` is not null, a filter that asserts `osgi.blueprint.compname=${componentName}`. This is a convenience function to easily refer to managers in other Blueprint Containers. Registered Blueprint services will automatically get this property set to their blueprint name.
- If filter is not null, the filter

The selection is defined as the set of Service References selected by the given filter.

### 121.7.9 Availability

A service reference is *satisfied* when one or more services match the selection. The availability is used to specify whether a service reference needs to be satisfied before initialization, see *Grace Period* on page 657, or if it controls the registration state of any service managers that depend on this service reference manager (explicit and implicit), see *Mandatory Dependencies* on page 698. The availability can have the following values:

- **mandatory** - Mandatory indicates that the service reference needs to be satisfied.
- **optional** - Optional indicates that the satisfaction of this reference is not relevant for any registered services, or for the grace period.

It is an error to declare a mandatory reference to a service that is registered by the same bundle. Such a definition could cause either deadlock or a timeout.

The fact that Blueprint specification has mandatory service references gives no guarantee that a valid service object is available when the service reference is used, in the dynamic world of OSGi, services can get unregistered at any time.

The following example declares a mandatory service reference for a single service. The usage of the reference can stall a maximum of 5 seconds if no service matches the selection.

```
<reference
  id          = "log"
  interface   = "org.osgi.service.log.LogService"
  availability = "mandatory"
  timeout     = "5000" />
```

### 121.7.10 Reference Listeners

The `referenceListeners` are represented as `ReferenceListener` objects. They define the following callbacks:

- **bindMethod** - Called after a service is selected by the service reference manager. For a reference manager, this method can be called repeatedly without an intermediate unbind callback. This happens when a service is unregistered but a replacement can be found immediately.
- **unbindMethod** - Called when the service is no longer used by the service reference manager but before it has been returned to the service registry with the `unset` method. For a reference manager, no unbind method is called when the service can immediately be replaced with an alternative service when the service goes away.

A reference listener callback can have any of the following signatures:

- `public void(ServiceReference)` - Provide the `ServiceReference` object associated with this service reference. This callback type provides access to the service's properties without actually getting the service.
- `public void( super T)` - Provide the proxy to the service object, where `T` is one of the types implemented by the service object proxy.
- `public void ( super T,Map)` - Provide the proxy to the service object. `T` is a type that is assignable from the service object. The `Map` object provides the service properties of the corresponding `ServiceReference` object.

All signatures must be supported regardless of the value of `memberType` that was specified in the reference-list. The service object given to the reference listeners must be the proxy to the service object.

The callbacks must be made synchronously with the corresponding OSGi service event. For reference-list callbacks, the service proxy is guaranteed to be available in the collection before a bind callback is invoked, and to remain in the collection until after an unbind callback has completed.

If a service listener defines multiple overloaded methods for a callback, then every method with a matching signature is invoked in an undefined order.

For example, the following definition will result in calling all the setLog methods on a FooImpl object:

```
<reference id="log"
  interface="org.osgi.service.log.LogService">
  <reference-listener
    bind-method="setLog">
    <bean class="com.acme.FooImpl"/>
  </reference-listener>
</reference>
```

```
public class FooImpl {
  public void setLog(Object o, Map m) { ... }
  public void setLog(LogService l, Map m) { ... }
  public void setLog(ServiceReference ref) { ... }
}
```

The manager that provides the reference listener object is treated as an implicit dependency of the enclosing service reference. This manager is specifically allowed to use the service reference in a property injection or constructor argument, though this is technically a cyclic dependency. Therefore, a bean must be allowed to both be injected with a reference as well as listening to the bind and unbind callbacks of that same reference.

In the following example, the foo reference manager uses manager main, both as a reference listener as well as manager main being injected with reference foo.

```
<reference id="foo" interface="com.acme.Foo">
  <reference-listener bind-method="setL" ref="main"/>
</reference>
<bean id="main" class="com.acme.Main">
  <property name="r" ref="foo"/>
</bean>
```

### 121.7.11 Service Proxies

The Blueprint extender must generate proxies for the service reference managers. Reference managers provide proxies that dynamically select a *backing* service, which can change over time. A reference-list provides a list of proxies that have a fixed backing service, these proxies are added and removed from the list. Based on the selection, they do not have a time-out.

The backing service for a reference proxy must not be gotten from the OSGi service registry until an actual service object is needed, that is, when an actual method is called on the proxy. If the backing service becomes unregistered, then the proxy must unget the reference to the backing service (if it had gotten it) and get another service object the next time a method on the proxy is called. If a replacement can be found immediately, the reference listener's bind method must be called without calling the unbind method. Other threads that need the same service object must block until the service object has become available or times out.

The proxies must implement all the methods that are defined in the interface. The interface must refer to an interface, not a class. The proxy must only support the methods in the given interface. That is, it must not proxy methods available on the service object that are not available in the given

interface. If no interface is defined, the proxy must be implemented as if the interface had no methods defined.

Blueprint bundles must ensure that the proper semantics are maintained for hashCode and equals methods. If these methods are not defined in the interface, then the proxy must use the default semantics of the Object class for equals and hashCode methods.

### 121.7.12 Activation and Deactivation

Service reference managers are active before activation because they must handle the enable status of service managers.

During activation, a service reference must actuate its listeners and provide these listeners with the initial state of the reference. For a reference, if there is a selected object, the bind method must be called with the proxy object, otherwise the unbind method must be called with a null as proxy object. For a reference-list, the bind method must be called for each member of the list. If the list is empty, the unbind method must be called with a null as proxy object.

During deactivation, the listeners must be disabled.

## 121.8 Object Values

Top-level managers can use *object values* in different places. These object values are defined with XML elements and attributes. After parsing, they are all converted to sub-interfaces of the Metadata interface, transitively reachable from top-level managers. For example, the following definition creates a bean that is injected with the byte array: `byte[] {7,42}`:

```
<bean class="com.acme.FooImpl">
  <property name="array">
    <array value-type="byte">
      <value>7</value>
      <value>42</value>
    </array>
  </property>
</bean>
```

This definition provides the configuration data for an *array value*, which is represented by the CollectionMetadata interface. A Metadata object can be used to construct its object value during runtime whenever a new object must be constructed.

In most places where an object value can be used, it can be anything, including objects provided by a managers and even null. However, maps require non-null keys. The object values are therefore split in value and nonNullValue types.

The syntax for object values has the following structure:

```
nonNullValue ::= <ref>
               | <idref>
               | <value>
               | <map>
               | <props>
               | collection
               | manager // see manager on page 662
value         ::= nonNullValue | <null>
collection    ::= <list> | <set> | <array>
```

Object values also include inlined managers. The use of an inlined manager for an object value means that manager will provide a value every time the object value is constructed. Each of the ob-

ject values is created anew and the types are mutable, except for the service references. The use of managers in object values must create an implicit dependency between the top level managers and any transitively reachable manager from their Metadata.

### 121.8.1 <ref>

The ref element is a reference to a top-level manager in the same Blueprint Container. The ref element has a single attribute component-id.

Table 121.12 *RefFeatures*

Attribute	Type	Ref Metadata	Description
component-id	NCName	componentId : String	A reference to a top level manager.

For example, the following definition uses the foo manager to instantiate the service object.

```
<service id="fooService" interface="com.acme.Foo">
  <ref component-id="fooImpl"/>
</service>
<bean id="fooImpl" class="com.acme.FooImpl"/>
```

```
public class FooImpl implements Foo { }
```

### 121.8.2 <idref>

The idref element provides the component id of another manager in the same Blueprint Container. This reference can then be used by the application to look up a manager in the Blueprint Container during runtime. The idref element is a safe way to provide a component id because the Blueprint Container will verify that the component id exists, thereby showing errors early. The idref does not create an implicit dependency on the given manager.

Table 121.13 *IdRefFeatures*

Attribute	Type	Id Ref Metadata	Description
component-id	NCName	componentId : String	A reference to a top level manager.

The following example provides the foo object with the reference to the database.

```
<bean id="foo" class="com.acme.FooImpl">
  <property name="db">
    <idref component-id="jdbc"/>
  </property>
</bean>

<bean id="jdbc" ... />
```

The following definition is equivalent to except that a non existent component id will not be detected until the foo object access the Blueprint Container. In the previous example this was detected directly after the definitions were parsed.

```
<bean id="foo" class="com.acme.FooImpl">
  <property name="db" value="jdbc"/>
</bean>
```



```
<bean id="jdbc" ... />
```

### 121.8.3 <value>

A value element represents an object that can directly be constructed from a string formed by its text contents.

Table 121.14 Value Features

Attribute, Element	Type	Value Metadata	Description
type	type	type : String	The optional type name to be used in type converting the given string to a target type. This type can commit the conversion to a specific choice. If this type is not set, then it must return null. For the type syntax, see <i>Syntax for Java types</i> on page 660.
...	<<type>>	stringValue : String	The string value that must be converted to the target type, if set.

If a value element is used as a member in a list, map, array, or set then the enclosing collection can define a default value for the type attribute of its value elements.

The following example creates a list of two OSGi version objects.

```
<list value-type="org.osgi.framework.Version">
  <value>1.3.4</value>
  <value>5.6.2.v200911121020</value>
</list>
```

The corresponding Java code is:

```
Arrays.asList( new Version("1.3.4"),
              new Version("5.6.2.v200911121020") )
```

### 121.8.4 <null>

A null element results in a Java null. It has no attributes and no elements. It corresponds to Null Metadata.

### 121.8.5 <list>, <set>, <array>

Lists, sets, and arrays are referred to as *collections*. List and array are ordered sequences of objects, where equal objects can occur multiple times. A set discards equal objects.

The structure of a collection element is:

```
collection ::= value *
```

Table 121.15 Collection Features

Attribute or Element	Type	Collection Metadata	Description
value-type	type	valueType : String	Optionally set the type for ValueMetadata children.

Attribute or Element	Type	Collection Metadata	Description
		collectionClass : Class< List   Set   Object[] >	The actual collection class to be used, derived from the appropriate definition.
<...>	object*	values : List<Metadata>	The Metadata for the children of the collection

The valueType sets the default for any contained ValueMetadata objects. The result of a collection element is an object that implements the given collection interface or is an Object[]. That is, the resulting object is mutable and can be used by the application. However, type conversion can create a copy of this list.

The following example creates a List of Lists of 2x2 of int values:

```
<list>
  <list value-type="int">
    <value>2</value>
    <value>7</value>
  </list>
  <list value-type="int">
    <value>9</value>
    <value>5</value>
  </list>
</list>
```

The corresponding Java code is:

```
Arrays.asList(
    new int[] {2, 7},
    new int[] {9, 5},
)
```

## 121.8.6

### <map>

A map is a sequence of associations between a *key* and some object., this association is called an *entry*. The structure of a map element is therefore:

```
map ::= <entry> *
```

Table 121.16

Map Features

Attribute or Element	Type	Map Metadata	Description
key-type	type	keyType : String	Optional default type for keys. For the syntax see <i>Syntax for Java types</i> on page 660.
value-type	type	valueType : String	Optional default type for values. For the syntax see <i>Syntax for Java types</i> on page 660.
<entry>	See <entry> on page 687.	values : List<MapEntry>	The MapEntry object for the children of the map or properties.

There are no additional constraints.

**121.8.7 <entry>**

The entry element provides an association between a key and a value. The structure of the element is:

```
entry ::= <key> object
key   ::= nonNullValue
```

Table 121.17 *Entry Features*

Attribute	Type	Map Entry	Description
key	<<type>>	key : NonNullMetadata	Specify the key of the entry.
key-ref	NCName	key : NonNullMetadata	Reference to a top-level manager
<key>	nonNull-Value	key : NonNullMetadata	Contains an inlined value that is never null.
value	<<type>>	value : Metadata	Specify the value directly, this will be a string type.
value-ref	NCName	value : RefMetadata	A reference to a top-level manager
<...>	object	value : Metadata	An inlined manager

Additional constraints:

- key, key-ref attributes and key element are mutually exclusive.
- value, value-ref attributes and value element are mutually exclusive.
- The resulting object of a key must not be a primitive type.

The following example shows the different way an entry can get its key. In this case the value is always a string.

```
<map>
  <entry key="bar" value="..." /> // 1
  <entry key-ref="bar" value="..." /> // 2
  <entry value="..." /> // 3
    <key>
      <value type="org.osgi.framework.Version">
        2.71
      </value>
    </key>
  </entry>
</map>
```

The previous example is equivalent to the following Java code:

```
Map m = new HashMap();
m.put( "bar", "...");
m.put( container.getComponentInstance("bar"), "...");
m.put( new Version("2.71"), "...");
```

The following examples shows the different ways a value of an entry can be defined.

```
<map>
  <entry key="1" value="1"/>
  <entry key="2" value-ref="foo"/>
  <entry key="3">
    <value type="org.osgi.framework.Version">3.14</value>
  </entry>
</map>
```

The previous code is equivalent to the following Java code.

```
Map m = new HashMap()
m.put("1", "1");
m.put("2", container.getComponentInstance("foo"))
m.put("3", new Version("3.14"));
```

### 121.8.8

#### <props>

The props element specifies a Properties object. The structure of a props element is as follows:

```
props ::= prop *
```

Each prop element is an association between two strings. It defines the following attributes:

- key - A string specifying the property key. This attribute is required.
- value - A string specifying the property value.

The following example initializes the same Properties object in two s ways.

```
<props>
  <prop key="1">one</prop>
  <prop key="2">two</prop>
</props>

<props>
  <prop key="1" value="one"/>
  <prop key="2" value="two"/>
</props>
```

This is equivalent to the following Java code:

```
Properties p = new Properties();
p.setProperty( "1", "one");
p.setProperty( "2", "two");
```

### 121.8.9

#### Manager as Value

Each manager can be the provider of component instances that act as object values. When a manager is used in an object value, then that is the manager asked to provide a component instance. The managers are specified in *manager* on page 662. The simple example is a bean. Any inlined bean can act as an object value. For example:

```
<list>
  <bean class="com.acme.FooImpl"/>
</list>
```

Some managers have side effects when they are instantiated. For example, a service manager will result in a ServiceRegistration object but it will also register a service.

```
<map>
  <entry key="foo">
    <service interface="com.acme.Foo">
      <bean class="com.acme.FooImpl"/>
    </service>
  </entry>
</map>
```

## 121.9 Dependency Injection

A bean has a recipe for constructing a component instance with a constructor or factory and then providing it with its *properties*. These properties are then injected with *object values*, see *Object Values* on page 683.

The following types of dependencies can be injected:

- *Constructor arguments* - The arguments specify the parameters for a constructor.
- *Static Factory arguments* - The arguments specify the parameters for a static method.
- *Instance Factory arguments* - The arguments specify the parameters for a method on an object provided by another manager.
- *Properties* - The value of the Bean Property specifies the single parameter for the property's set method.

In all the previous cases, the Blueprint Container must find an appropriate method or constructor to inject the dependent objects into the bean. The process of selecting the correct method or constructor is described in the following section, which assumes a Bean Argument as context, where a Bean Property acts as a Bean Argument without an index or type set.

### 121.9.1 Signature Disambiguation

Constructors, factory methods, and property set methods are described with Metadata. The Blueprint Container must map these descriptions to an actual method or constructor. In practice, there can be multiple methods/constructors that could potentially map to the same description. It is therefore necessary to disambiguate this selection. Both factory methods and constructors have the same concept of *signatures*. A signature consists of an ordered sequence of zero or more types. For methods, only publicly accessible methods with the appropriate name are considered. For constructors, all publicly accessible constructors are considered. The disambiguation process described here is valid for all constructors and methods because the signature concept applies to both of them.

1. Discard any signatures that have the wrong cardinality
2. Find the list of signatures that have *assignable* types for each argument in their corresponding positions. Assignable is defined in *Type Compatibility* on page 690. If a type was specified for an argument, then this type must match the name of the corresponding reified type in the signature exactly.
3. If this result list has one element, then this element is the answer. If this list has more than one element, then the disambiguation fails.
4. Otherwise, find the list of signatures that have *compatible* types for each argument in their corresponding positions. Compatibility is defined in *Type Compatibility* on page 690.
5. If this result list has one element, then this element is the answer. If the list has more than one element, then the disambiguation fails.
6. If the arguments cannot be reordered (the index of the argument is used and is thus not -1, or there are less than two arguments) then the disambiguation fails.
7. Find all signatures that match a re-ordered combination of the arguments. Reordering must begin with the first argument and match this argument against the first *assignable* types in a sig-

nature, going from position 0 to n. If the type is assignable from the argument, then it is locked in that position. If the argument has a type, then it must exactly match the name of the selected signature type. The same is done for the subsequent arguments. If all arguments can find an exclusive position in the signature this way, then the signature is added to the result.

8. If the result list contains one signature, then this is the resulting signature. If the list has more than one element, then the disambiguation fails.
9. Repeat step 6, but now look for *compatible* types instead of assignable types.
10. If the result list contains one signature, then this is the resulting signature.
11. Otherwise, the disambiguation fails

An example elucidates how the disambiguation works. Assuming the following definition and classes:

```
<bean ... >
  <argument>
    <bean class="Bar" />
  </argument>
  <argument>
    <bean class="Foo" />
  </argument>
</bean>

public class Bar extends Foo {}
public class Foo {}
```

The following bullets provide examples how signatures are matched against the previous definition.

- (Bar,Foo) - The arguments will be in the given order and the ordered match will succeed. This is the normal case.
- (Foo,Bar) - This will not match because in the re-ordered match, the Bar argument (which is a Foo sub-type) is matched against the first argument. The second Foo argument can then no longer find a compatible type because that slot is taken by the Bar instance.
- (Object,Object) - This will be called with (aBar,aFoo).

Multiple constructors on a class can require disambiguation with the arguments type. In the following example, the Multiple class has two constructors that would both match the constructor arguments because a String object can be converted to both a File object and a URL object.

```
public class Multiple {
  public Multiple(URL a);
  public Multiple(File a);
}
```

An attempt to configure a Multiple object without the type will fail, because it is not possible to determine the correct constructor. Therefore, the type should be set to disambiguate this:

```
<bean class="Multiple">
  <argument type="java.net.URL" value="http://www.acme.us"/>
</bean>
```

## 121.9.2 Type Compatibility

During injection, it is necessary to decide about type *assignability* or type *compatibility* in several places. If generics are present, a type must be *reified* in its class, see *Generics* on page 695. In this specification, the canonical representation for a type is  $T\langle P_1..P_n \rangle$ , where n is zero for a non-param-

terized type, which is always true in a VM less than Java 5. The `ReifiedType` class models this kind of type.

If type `T` or `S` is primitive, then they are treated as their corresponding wrapper class for deciding assignability and compatibility. Therefore, a type `T<P1..Pn>` (target) is *assignable* from an object `s` of type `S` (source) when the following is true:

- `n == 0`, and
- `T.isAssignableFrom(S)`

`T<P1..Pn>` is *compatible* with an object `s` of type `S` when it is assignable or it can be converted using the Blueprint built-in type converter. The convertability must be verified with the `canConvert(s,T<P1..Pn>)` method. That is, type compatibility is defined as:

- `assignable(T<P1..Pn>,S)`, and
- `cs.canConvert(s,T<P1..Pn>)` returns true

Where `cs` is the Blueprint built in type converter that also uses the custom type converters.

### 121.9.3 Type Conversion

Strings in Blueprint definitions, object values, and component instances must be made compatible with the type expected by an injection target (method or constructor argument, or property) before being injected, which can require *type conversion*. The Blueprint Container supports a number of built-in type conversions, and provides an extension mechanism for configuring additional type converters. Custom type converters have priority over built-in converters.

The goal of the type conversion is to convert a source object `s` with type `S` to a target type `T<P1..Pn>`. The conversion of the Blueprint built-in type converter must take place in the following order:

1. If `T<P1..Pn>` is assignable from `S`, which implies `n=0`, then no conversion is necessary, except that primitives must be converted to their wrapper types.
2. Try all type converters in declaration order with the `canConvert(s,T<P1..Pn>)` method, exceptions are ignored and logged. The first converter that returns true is considered the converter, its result is obtained by calling `convert(s,T<P1..Pn>)`. Exceptions in this method must be treated as an error.
3. If `T` is an array, then `S` must be an array or it must implement `Collection`, otherwise the conversion fails. Each member of array `s` must be type converted to the component type of `T` using the generics information if available, see the `getComponentType` method on `Class`. This is a recursive process. The result must be stored in an array of type `T`.
4. If `T` implements `Collection`, then `S` must be an array or implement `Collection`, otherwise the conversion fails. If the platform supports generics, the members of object `s` must be converted to the member type of the collection if this is available from the generics information, or to `Object` otherwise. The Blueprint Container must create a target collection and add all members of `s` to this new object in the iteration order of `s`. The target collection depends on type `T`:
  - If `T` is one of the interfaces listed in *Concrete Types for Interfaces* on page 694, then the target collection must be the corresponding concrete class.
  - `T` must represent a public concrete class with an empty publicly accessible constructor, the target collection is then a new instance of `T`.
  - Otherwise `T` represents an interface and the conversion must fail.
5. If `T` implements `Map` or extends `Dictionary`, then `S` must implement `Map` or extend `Dictionary` as well, otherwise the conversion fails. If the platform supports generics, the members of map `s` must be converted to the key and value type of the target map. This is a recursive process. Without generics, the members are not converted and put as is.

The target map depends on `T`:

- If T is a public concrete class (not interface) with an empty publicly accessible constructor then the target map must be a new instance of T.
  - If T is one of the Map interfaces or Dictionary listed in *Concrete Types for Interfaces* on page 694, then the target map must be the corresponding concrete class.
  - Otherwise, the conversion fails.
6. If T is one of the primitive types (byte, char, short, int, long, float, double, boolean) then treat T as the corresponding wrapper class.
  7. If T extends class Number and S extends also class Number then convert the source to a number of type T. If the target type cannot hold the value then the conversion fails. However, precision may be lost if a double or float is converted to one of the integer types.
  8. If source type S is not class String, then the conversion fails.
  9. The conversion is attempted based on the target type T from the string s. The following target types are supported:
    - boolean or Boolean - Construct the appropriate boolean type while accepting the following additional values for true and false respectively:
      - yes, no
      - on, off
    - Character - The string s must have a length of 1, this single character is then converted to a Character object.
    - Locale - The string s is converted to a Locale using the following syntax (no spaces are allowed between terms).
 

```
locale ::= <java language-code> ( '_' country)+
country ::= <java country-code> ( '_' <java variant-code>)+
```
    - Pattern - Create the Pattern object with Pattern.compile(String).
    - Properties - Create a new Properties object and load the properties from the string. The string must follow the format described with the Properties.load method.
    - Enum subclass - Convert the string s to the appropriate member of the given enum with the Enum.valueOf method. If the string is not one of the enum values, then the conversion must fail.
    - Class - The string s must conform to the syntax in *Syntax for Java types* on page 660. This type must be loaded through the Bundle's loadClass method. The resulting class must match any generic constraints on T. If this fails, the conversion fails.
  10. If target type T has a constructor (String), then use this constructor to create an instance with the source string s. This convention caters for many of the built-in Java types such as BigDecimal, BigInteger, File, URL, and so on, as well as for custom types.

If none of the above steps has found a proper conversion than the conversion fails. Failing a conversion must end with throwing an Illegal Argument Exception.

#### 121.9.4 Type Converters

A type converter converts a source type to a target type. The source type for a type converter is not constrained. A type converter must support the following methods:

- [canConvert\(Object, ReifiedType\)](#) - A light weight method that inspects the object and returns true if it can convert it to the given Reified Type, false otherwise. Converters normally can convert a type S to a type T<...>. However, converters can convert to multiple types and the value of the source object can influence the returned type. For example, a converter could convert a string to a type based on its content.
- [convert\(Object, ReifiedType\)](#) - The actual conversion method. This method should not fail if the canConvert method has returned true.



The `ReifiedType` class provides access to the target class. In a Java 1.4 environment, the `ReifiedType` object will provide a `Class` object for conversion and no type arguments. In a Java 5 environment, the `ReifiedType` object provides access to the reified class as well as the type arguments. Generics and reified types are described in *Generics* on page 695.

Type converters are normal managers with some limitations due to the dependency handling. If they depend on general managers or services then there is a change that cyclic dependencies are created.

Converters must be defined in the `type-converters` element, see `<type-converters>` on page 662, to be registered as a converter. Component instances of managers in this section must implement the `Converter` interface. Converters must also only transitively depend on built-in converters. It must be possible to initialize all converters before any of them are used. Type converters should not use the type conversion before all type converters are fully configured.

Converters are ordered within one definition resource but there is no resource ordering, so the overall ordering is not defined, making it a good practice to concentrate all converters in a single XML definition. The definition ordering is used during type conversion. That is, converters are not ordered by their specialization, a converter that is earlier can convert a more general type will override a converter that is later in the list but could have converted to a more specific type.

Converters must always use the type arguments of the given `ReifiedType`, even if they are running on Java 1.4. The default behavior of the `ReifiedType` will automatically work.

The following example demonstrates how a converter can use generics to use an `AtomicReference<T>` whenever type `T` is supported. Such a type could be for a property like:

```
public void setInteger( AtomicReference<Integer>atomic );
```

The `Atomic Converter` uses the generic argument to convert a source object to an `Integer` and then creates an `AtomicReference` with this converted object. The definition of the type converter looks like:

```
<type-converters>
  <bean class="AtomicConverter">
    <argument ref="blueprintConverter"/>
  </bean>
</type-converters>
```

The `Blueprint converter` is injected in the constructor of the `AtomicInteger` class, in order to allow the conversion of the generic arguments. The `Blueprint built-in type converter` must not be used before all type converters are registered because a needed type converter might not have been registered yet. This is the reason type converters should not require type conversion in their initialization because the state of this converter is not well defined at this time.

The conversion class looks like:

```
public class AtomicConverter {
    Converter bpc;
    public AtomicConverter(Converter bpc) { this.bpc=bpc; }

    public boolean canConvert(Object s,ReifiedType T) {
        return T.getRawClass() == AtomicReference.class
            && bpc.canConvert(s, T.getActualTypeArgument());
    }

    public Object convert( Object s, ReifiedType T )
        throws Exception {
        Object obj = bpc.convert(
```

```
s, T.getActualTypeArgument(0) );
    return new AtomicReference<Object>(obj);
}
}
```

Any injection that now targets an AtomicReference<T> value will automatically be converted into an AtomicReference of the appropriate type because of the example converter. The following definitions test this behavior:

```
public class Foo<T extends Integer> {
    public Foo( AtomicReference<T> v ) {}
}
```

```
<bean id="foo" class="Foo"> <argument value="6"/> </bean>
```

This definition will create an foo object with the Foo(AtomicReference<T>) constructor. The source type is a string and there is no assignability for an Atomic Reference, so the registered type converters are consulted. The Atomic Converter recognizes that the target T is an AtomicReference class and indicates it can convert. The convert method then uses the generic argument information, which is an Integer object in the example, to convert the string "6" to an Integer object and return the appropriate AtomicReference object.

### 121.9.5 Built-in Converter

A Blueprint Container must contain an environment manager called blueprintConverter. The related component instance must implement the Converter interface.

The built-in Converter provides access to the provided type converters as well as the built in types. This service provides the type conversion as defined in *Type Conversion* on page 691.

Injecting a reference to the blueprintConverter environment manager into a bean provides access to all the type conversions that the Blueprint Container and registered type converters are able to perform. However, if this converter is injected in a type converter, then by definition, not all custom type converters are yet registered with the built-in converter. Type converters should therefore in general not rely on type conversion during their construction.

### 121.9.6 Concrete Types for Interfaces

The Blueprint extender can choose an implementation class when it provides an instance during conversion to an interface as well as when it natively provides an object. The actual implementation class can make a noticeable difference in disambiguation, type conversion, and general behavior. Therefore this sections describe the concrete types an implementation must use for specific interfaces if the platform allows this.

Table 121.18 Implementation types for interfaces

	Interface/Abstract class	Implementation class
	Collection	ArrayList
	List	ArrayList
Java 5	Queue	LinkedList
	Set	LinkedHashSet
	SortedSet	TreeSet
	Map	LinkedHashMap
	SortedMap	TreeMap
Java 5	ConcurrentMap	ConcurrentHashMap

**Interface/Abstract class**

Dictionary

**Implementation class**

Hashtable

If possible, the instances of these types must preserve the definition ordering.

**121.9.7****Generics**

Java 5 introduced the concept of *generics*. Before Java 5, a *type*, was simply a class or interface, both represented by the Class object. Generics augment these classes and interfaces with additional *type constraints*. These type constraints are not available on an instance because an instance always references a raw Class. For an instance all generic type constraints are *erased*. That is, a List<Integer> object is indistinguishable from a List<String> object, which are indistinguishable from a List object. Objects always refer to a raw Class object, this is the one returned from the getClass method. This Class object is shared between all instances and can therefore not have the actual type constraints (like String, Integer in the list examples).

When a class is used the compiler captures the type constraints and associates them with the specific use and encodes them in a Type object. For example, a field declaration captures the full generic type information:

```
List<String> strings;
```

A field has a getGenericType method that provides access to a Type object, which is a super interface for all type information in the Java 5 and later runtime. In the previous example, this would be a Parameterized Type that has a raw class of List and a type argument that is the String class. These constraints are reflectively available for:

- A superclass
- Implemented interfaces
- Fields
- For each method or constructor:
  - Return type
  - Exception types
  - Parameter types

Generics influence the type conversion rules because most of the time the Blueprint extender knows the actual Type object for an injection. Therefore, conversion must take place to a type like T<P1..Pn>, where T is a raw Class object and P1..Pn form the available type parameters. For a non-parameterized class and for other VMs than 1.4, n is always zero, that is no type arguments are available. The P arguments are in itself instances of Type. The form T<P1..Pn> is called the *reified* form. It can be constructed by traversing the Type graph and calculating a class that matches the constraints. For example < extends List<T>> defines a *wild card* constraint, that has a List<T> as reified type, where T is a Type Variable defined elsewhere that can have additional constraints. The resulting type must be an instance of List<T>. A reified type will use an object implementing List for such an example because that is the only class that is guaranteed to be compatible. The rules to reify the different Type interfaces are:

- Class - A Class represents unparameterized raw type and is reified into T<>. For example:

```
String string;
```

- ParameterizedType - A Parameterized Type defines a raw type and 1..n typed parameters. The raw type of the Parameterized Type is also reified and represents T. The arguments map directly to the arguments of the reified form. An example of a Parameterized Type is:

```
Map<String, Object> map;
```

- **TypeVariable** - Represents a Type Variable. A type variable is listed in a generics type declaration, for example in `Map<K,V>`, the `K` and `V` are the type variables. A type variable is bounded by a number of types because it is possible to declare a bounded type like: `<A extends Readable&Closeable>`. A Type Variable is reified by taking its first bound in reified form, this is the same as in Java 5 where the first bounds is the erasure type. However, this can fail if multiple bounds are present. An example of a Type Variable is:

```
public <T extends ServiceTracker> void setMap(T st) {}
```

In this example, the parameter `st` will have a reified type of `ServiceTracker`.

- **WildcardType** - A Wildcard Type constrains a type to a set of lower bounds and a set of upper bounds, at least in the reflective API. In the Java 5 and later syntax a Wildcard Type can only specify 0 or one lower and one upper bound, for example `<T extends Number>` constrains the Type Variable `T` to at least extend the `Number` class. A Wildcard Type is reified into its reified upper bound when no lower bound is set, and otherwise it is reified into its reified lower bound. An example of a Wildcard Type is seen in the example of a Type Variable.
- **GenericArrayType** - A Generic Array Type represents an array. Its component type is reified and then converted to an array. The Reified Type will have the array class as reified class and the type arguments reflect the type arguments of the component type. For example:

```
public void setLists(List<String>[] lists) {}
```

This example will have a Reified Type of `List[]<String>`.

This specification is written to allow Java 1.4 implementations and clients, the API therefore has no generics. Therefore, the `Type` class in Java 5 and later cannot be used in the API. However, even if it could use the `Type` class, using the type classes to create the reified form is non-trivial and error prone. The API therefore provides a concrete class that gives convenient access to the reified form without requiring the usage of the `Type` class.

The `ReifiedType` class provides access to the reified form of `Class`, which is itself and has no type arguments. However, Blueprint extender implementations that recognize Java 5 generics should subclass the `ReifiedType` class and use this in the conversion process. The subclass can calculate the reified form of any `Type` subclasses.

## 121.10 Service Dynamics

The Blueprint Container specification handles the complexities of the dynamic nature of OSGi by *hiding* the dynamic behavior of the OSGi service registry, at least temporarily. This dynamic behavior is caused by service references that select one or more services that can come and go at runtime.

The Blueprint Container must handle the dynamics in the following way:

- *Proxied references* - Service reference managers must provide a proxy implementing the specified interfaces, instead of the actual service object it refers to. The proxy must fetch the real service lazily. For reference managers, when a proxy is used, and no candidate is available, a candidate must be found within a limited time. If no candidate service is available during this time, a `Service Unavailable Exception` must be thrown. The reference-list manager also maintains proxies but these proxies must throw a `Service Unavailable Exception` immediately when the proxy is used and the backing service is no longer available.

When proxied references are used with stateful services, then the application code must register a reference listener to perform the necessary initialization and cleanup when a new backing service is bound.

- *Conditional Service Registrations* - The service manager is responsible for registering a service with the OSGi service registry. A service manager is statically dependent on the transitive set of man-

agers that it depends on. If these static dependencies contain mandatory service references, then the manager's service must not be registered when any of these mandatory service references is unsatisfied, see *Enabled* on page 676.

### 121.10.1 Damping

When an operation is invoked on an unsatisfied proxy from a reference manager (either optional or mandatory), the invocation must block until either the reference becomes satisfied or a time-out expires (whichever comes first). During this wait, a *WAITING* event must be broadcast, see *Events* on page 699.

The default timeout for service invocations is 5 minutes. The optional timeout of the reference element specifies an alternate timeout (in milliseconds). If no matching service becomes available within the timeout, then a *Service Unavailable Exception* must be thrown. A timeout of zero means infinite and a negative timeout is an error.

For example:

```
<reference id="logService"
  interface="org.osgi.service.log.LogService"
  timeout="100000" />

<bean id="bar" class="BarImpl">
  <property name="log" ref="logService"/>
</bean>
```

When this Blueprint Container is instantiated, the reference manager provides a proxy for the Log Service, which gets injected in the *log* property. If no Log Service is available, then the proxy will have no backing service. If the *bar* object attempts to log, it will block and if the timeout expires the proxy must throw a *Service Unavailable Exception*.

If at some later point in time, a Log Service is registered then it becomes satisfied again. If *bar* now logs a message, the proxy will get the service object again and forward the method invocation to the actual Log Service implementation.

The damping ensures that a mandatory service reference that becomes unsatisfied does not cause the Blueprint Container to be destroyed. Temporary absences of mandatory services are tolerated to allow for administrative operations and continuous operation of as much of the system as possible.

A reference-list manager does not provide damping. It only removes the service proxy from the collection if its service goes away. Using a collection reference manager will never block, it will just have no members if its selection is empty. A timeout attribute is therefore not supported by the reference-list elements. However, the elements are proxied and it is possible that they throw a *Service Unavailable Exception* when used and the backing service has disappeared. The exceptions for a reference-list proxy will be thrown immediately when the proxy is used.

### 121.10.2 Iteration

The provided object of a reference-list manager implements the *List* interface. Depending on the *memberType* or the optional generics information, it provides a collection that contains the member objects, that is, either proxies to the service object, or *ServiceReference* objects. These collections are read-only for the receiver, however, their contents can dynamically change due to changes in the selection. The access to these collections with iterators must give a number of guarantees:

- *Safe* - All iterators of reference-list managers must be safe to traverse according to the *Iterator* interface contract, even while the underlying collection is being modified locally or in another thread. If the *hasNext* method returns true, the iterator must return a member object on the subsequent next method invocation. If there is no longer a service object available when requested, then a dummy proxy must be returned that throws a *Service Unavailable Exception* whenever it is used.

- *Visibility* - All the changes made to the collection that affect member objects not yet returned by the iterator must be visible in the iteration. Proxies for new services must be added at the end of the List. Proxies already returned can be affected by changes in the service registry after the iterator has returned them.

After the iterator has returned false for the `hasNext` method, no more objects can be obtained from it. A List Iterator must not be supported.

### 121.10.3 Mandatory Dependencies

A service manager can have mandatory service reference managers in its transitive dependencies. Such a service manager must ensure that the service object is registered with the OSGi service registry during the runtime phase when all its mandatory service references that it depends on are satisfied. This called *tracking* the dependency. A service manager is *enabled* when all its mandatory references in its dependencies are satisfied.

This tracking only works for dependencies declared directly in the definitions; dependencies established during runtime by calling the `getComponentInstance` method are not tracked.

In the following example, service manager S has a transitive dependency on the mandatory reference manager M, which means the Blueprint Container must ensure that the service object provided by bean A is registered when reference manager M is satisfied.

```
<service id="S" ref="A" interface="com.acme.Foo"/>
<bean id="A" class="com.acme.FooImpl">
  <property name="bar" ref="m"/>
</bean>
<reference id="M" interface="com.acme.Bar"
  availability="mandatory"/>
```

However, if the dependency from manager A on manager M is not declared but created through code that manipulates the Blueprint Container then the dependency is not tracked.

## 121.11 Blueprint Container

The Blueprint Container has a registry where all top-level managers, as well as *environment* managers, are registered by their component id. The Blueprint Container can be injected in application code with the environment blueprintContainer manager. For example:

```
<bean class="com.acme.FooImpl">
  <property name="container" ref="blueprintContainer"/>
</bean>
```

The Blueprint Container allows application code to get objects that are provided by the top-level managers through the `getComponentInstance` method. However, the Blueprint Container should not be required to get a component instance; the proper way to use Blueprint is to inject them. This declarative approach makes the Blueprint Container aware of any dependencies; one of the primary goals of a dependency injection framework. The Blueprint Container's introspective features are commonly used for management and other non-application purposes.

The Blueprint Container is registered as a service during the runtime phase so that other bundles can use it for these, and other, purposes.

### 121.11.1 Environment Managers

The Blueprint Container provides a number of *environment managers*. These managers have defined names and provide convenient access to information about the environment. Environment man-

agers cannot be overridden by explicitly defined managers because it is invalid to define a manager with an existing component id. All component ids starting with blueprint are reserved for this specification and future incarnations.

There is no XML definition for environment managers but their Metadata must be provided as `ComponentMetadata` objects.

The following ids are used for the environment managers:

- `blueprintContainer` - The Blueprint Container.
- `blueprintBundle` - A manager that provides the Blueprint bundle's `Bundle` object.
- `blueprintBundleContext` - A manager that provides the Blueprint bundle's `BundleContext` object.
- `blueprintConverter` - A manager that provides an object implementing the `Converter` interface. This represents the built-in conversion facility that the Blueprint Container uses to convert objects. See *Built-in Converter* on page 694.

### 121.11.2 Component Instances

The Blueprint Container provides access to the component instances that the top level managers can provide, as well as their Metadata. The Blueprint Container has the following methods for requesting a component instance and to find out what managers are available:

- `getComponentInstance(String)` - This method will provide a component instance from the component id. If the manager has not been activated yet, it must atomically activate and ensure its explicit and implicit dependencies are activated transitively.
- `getComponentIds()` - Returns a set of component ids in this Blueprint Container. These ids must consist of all top level managers (including calculated ids) and environment managers.

### 121.11.3 Access to Component Metadata

Each of the manager types has specific Component Metadata subtypes associated with it, except Environment managers that use Component Metadata. The Blueprint Container provides access by component id to the Component Metadata of the top level managers. However, managers can also be defined inline, in which case they do not have a component id. Therefore, the Blueprint Container can also enumerate all the managers that are represented by a Metadata sub-interface.

- `getComponentMetadata(String)` - Answer the Component Metadata sub-type for the given component id. Environment managers will return a `ComponentMetadata` object, the other managers each have their own specific Metadata type.
- `getMetadata(Class)` - Answer a collection with the Metadata of the given type, regardless if it is defined as/in a top-level or inlined manager. For example, `getMetadata(ServiceMetadata.class)` returns all Service Metadata in the Blueprint container. This includes all top level managers as well as any inlined managers. For Environment Managers, this method returns a `ComponentMetadata` object.

### 121.11.4 Concurrency

A Blueprint Container must be thread safe. Each method must handle the case when multiple threads access the underlying registry of managers. Activation of managers must be atomic. That is, other threads must be blocked until a manager is completely activated.

The Blueprint Container must handle reentrant calls.

## 121.12 Events

The Blueprint Container must track all Blueprint Listener services and keep these listeners updated of the progress or failure of all its managed bundles. The Blueprint Listener is kept informed by

sending it events synchronously. These events are therefore normally delivered in order but in exceptional cases this can be seen out of order for a listener when new events are initiated synchronously from within a callback. Therefore, Blueprint Listener services should see the event as a notification, where actual work should be processed on another thread.

Blueprint Events must be sent to each registered Blueprint Listener service. This service has the following method:

- `blueprintEvent(BlueprintEvent)` - Notify the listener of a new Blueprint Event. These events are sent synchronously with their cause. That is, all listeners must be notified before the Blueprint Container continues to the next step.

The events must be delivered as `BlueprintEvent` objects. The event types that they represent, and the data that these objects carry, is further described in *Blueprint Event* on page 700.

A Blueprint Listener services must be given the initial state of all managed bundles before normal processing starts, see *Replay* on page 700.

Blueprint Listener services that throw Exceptions or do not return in a reasonable time as judged by the Blueprint extender implementation, should be logged, if possible, and further ignored.

### 121.12.1 Blueprint Event

The Blueprint Event supports the following event types:

- `CREATING` - The Blueprint extender has started creating a Blueprint Container for the bundle.
- `GRACE_PERIOD` - The Blueprint Container enters the grace period. This event can be repeated multiple times when the list of dependencies changes due to changes in the service registry.
- `CREATED` - The Blueprint Container is ready. The application is now running.
- `WAITING` - A service reference is blocking because of unsatisfied mandatory dependencies. This event can happen multiple times in a row.
- `DESTROYING` - The Blueprint Container is being destroyed because the Blueprint bundle or Blueprint extender has stopped.
- `DESTROYED` - The Blueprint Container is completely destroyed.
- `FAILURE` - An error occurred during the creation of the Blueprint Container.

The Blueprint Event provides the following methods:

- `getBundle()` - The Blueprint bundle
- `getCause()` - Any occurred exception or null
- `getDependencies()` - A list of filters that specify the unsatisfied mandatory references.
- `getExtenderBundle()` - The Blueprint extender bundle.
- `getTimestamp()` - The time the event occurred
- `getType()` - The type of the event.
- `isReplay()` - Indicates if the event is a replay (true) or if it is a new event (false), see *Replay* on page 700.

### 121.12.2 Replay

The Blueprint Extender must remember the last Blueprint Event for each ready bundle that it manages, see *Initialization Steps* on page 654. During the (synchronous) service registration event of a Blueprint Listener service, the Blueprint extender must inform the Blueprint Listener service about all its managed bundles by sending it the last known event for each bundle the Blueprint extender manages. This initial event is called the *replay* event, and is marked as such.

The replay event must be delivered to the Blueprint Listener service as the first event, before any other event is delivered, during the registration of the Blueprint Listener service. That is, the blue-



printEvent method must have returned before the first non-replay event can be delivered and no events must be lost. The replay events must be sent every time a Blueprint Listener service is registered.

The set of managed bundles is defined by bundles that are active and are managed by the Blueprint extender, even if their initialization ended in failure.

The BlueprintEvent object for a replay event must return true for the `isReplay()` method in this situation, and false in all other situations.

### 121.12.3 Event Admin Mapping

When the Event Admin service is present, the Blueprint extender must create an Event Admin event for each defined Blueprint Event. This Event Admin event must be asynchronously given to the Event Admin service with the `postEvent` method.

The topic of the Event Admin event is derived from the Blueprint event type with a fixed prefix. All topics must have the prefix of:

`TOPIC_BLUEPRINT_EVENTS`

After this prefix, the name of the Blueprint Event type must be used as the suffix. That is, `CREATING`, `GRACE_PERIOD`, etc. For example, `org/osgi/service/blueprint/container/GRACE_PERIOD`.

For each Blueprint event the following properties must be included:

- `TYPE` - The type of the Event, see *Blueprint Event* on page 700.
- `BUNDLE` - (Bundle) The Bundle object of the Blueprint bundle
- `BUNDLE_ID` - (Long) The id of the Blueprint bundle.
- `BUNDLE_SYMBOLICNAME` - (String) The Bundle Symbolic Name of the Blueprint bundle.
- `BUNDLE_VERSION` - (Version) The version of the Blueprint bundle.
- `EXTENDER_BUNDLE` - (Bundle) the Bundle object of the Blueprint extender bundle.
- `EXTENDER_BUNDLE_ID` - (Long) The id of the Blueprint extender bundle
- `EXTENDER_BUNDLE_SYMBOLICNAME` - (String) The Bundle Symbolic Name of the Blueprint extender bundle.
- `EXTENDER_BUNDLE_VERSION` - (Version) The version of the Blueprint extender bundle
- `TIMESTAMP` - (Long) The time when the event occurred
- `CAUSE` - (Throwable) The failure cause, only included for a FAILURE event.
- `DEPENDENCIES` - (String[]) The filter of an unsatisfied service reference. Can only appear in a `GRACE_PERIOD`, `WAITING` or `FAILURE` event caused by a time-out.
- `EVENT` - (BlueprintEvent) The BlueprintEvent object that caused this event.

The property names for Blueprint Listener events may be conveniently referenced using the constants defined in the `org.osgi.service.event.EventConstants` and `EventConstants` interfaces.

The Event Admin events do not follow the replay model in use for Blueprint Listener services. That is, the Event Admin must only be kept informed about events as they occur.

## 121.13 Class Loading

The module layer in OSGi provides advanced class loading rules that potentially can cause bundles to live in different class spaces. This means that not all bundles can collaborate because the classes involved in the collaboration can come from different class loaders, which results in confusing Class Cast Exceptions on classes with the same name. It is therefore crucial that the Blueprint Container uses the Bundle Context and the bundle class loader of the Blueprint bundle for all actions that are made on behalf of the Blueprint bundle. Especially, access to the OSGi service registry must

use the Bundle Context of the Blueprint bundle. Any dynamic class loading must use the Blueprint bundle's `loadClass` method. The normal OSGi mechanics will then ensure class space consistency for resolved bundles.

### 121.13.1 **Blueprint Extender and Bundle Compatibility**

For many Blueprint bundles, there is no class space compatibility issue. These bundles do not use any Blueprint classes and are therefore by definition compatible with any extender. However, if the Blueprint bundle uses some of the Blueprint packages, it must import these packages. Blueprint Containers must verify that they are *type compatible* with the Blueprint bundle before they attempt to manage it. See *Type Compatibility* on page 702.

### 121.13.2 **XML and Class Loading**

The Blueprint definition resources contain textual references to classes. These textual references will be loaded with the class loader of the Blueprint bundle. This implies that all the classes of provided component instances must be either imported or available from the bundle.

The Blueprint specification has the following attributes and elements that can cause imports:

- class
- value-type
- interface
- interfaces
- type
- key-type

All these attributes and elements are defined with the `Tclass` and `Ttype` XML Schema type for the Blueprint namespace. The `Tclass` defines simple class names, and `Ttype` defines types defined in *Syntax for Java types* on page 660.

### 121.13.3 **Foreign Bundle Context**

When using the Blueprint Container in its Blueprint bundle, the types that the managers provide are guaranteed to be compatible with the caller.

When using a Blueprint Container service in another bundle (for example, getting it as a service) then there is no guarantee of type compatibility or even visibility between the versions of the types of the returned managers, and the versions of the types visible to the caller. Care must therefore be taken when casting the return value of the `getComponentInstance` method to a more specific type.

### 121.13.4 **Converters and Class Loading**

A converter is closely coupled to its target class. If the converter comes from another bundle, then the converter bundle must ensure class space consistency between the converter implementation and the target class. This can be achieved by specifying the target class in the `uses` directive.

For example:

```
Export-Package:  
    com.converters.ac;uses:="com.converters.dc"
```

A bundle that references a type converter defined in the Blueprint bundle does not need to export that type. When creating a Blueprint Container, the extender bundle uses the class loader of the Blueprint bundle.

### 121.13.5 **Type Compatibility**

Two bundles are type compatible for a given class if they both load the same class object, or if either bundle cannot load the given class.

To mitigate type incompatibility problems, a Blueprint extender must export the `org.osgi.service.blueprint` package. In the `uses:` directive, it should list any packages of classes that can be shared between the Blueprint extender and the Blueprint bundle. Blueprint bundles should import this package.

### 121.13.6 Visibility and Accessibility

The Blueprint Container must load any classes it needs through the Blueprint bundle's `loadClass` method. If a class can not be loaded, then the initialization fails. Class loading issues are further discussed in *Class Loading* on page 701.

The Blueprint Container must respect the accessibility of the class and any of its members. That is, the Blueprint Container must not use the `setAccessibility` method. All classes and reflected members must therefore be declared public or be implicitly public like the default constructor.

## 121.14 Metadata

An important aspect of the Blueprint specification is the so called *metadata* interfaces. These interfaces are used in the Blueprint Container to enable programmatic access to the XML definitions. During the parsing phase the Blueprint Container reads the XML and converts it to an object implementing the appropriate interface.

The XML elements and XML Schema types map to the Metadata interfaces. For example, `<bean>` maps to `BeanMetadata`. However, in several cases, the attributes and/or sub-elements in the Metadata interfaces are merged when possible. For example, the `interface` attribute and `interfaces` element in the service element are merged in the `ServiceMetadata` class' `getInterfaces()` method.

The interfaces are arranged in a comprehensive hierarchy that reflects their usage and constraints. This hierarchy is depicted in Figure 121.12 on page 704.

The hierarchy can roughly be divided in two parts. The first part is the sub-interfaces of the `ComponentMetadata` interface. These interfaces are defining the configuration data of the top-level and in-lined managers. The manager's component instance(s) are injected with values during runtime. The configuration of how to create a specific value is also described with Metadata interfaces. For example, a `Map` object is described with configuration information in the `MapMetadata` interface. The hierarchy makes it clear that `ComponentMetadata` is also a value that can be injected. Keys in maps or properties can not be null. This is the reason the hierarchy is split at the top into a null value branch and a branch that can only generates non-null values.

The `Target` interface describes managers that can be used as the target for the reference listener or the registration listener, or a `ref`.

Figure 121.12 Metadata Interfaces Hierarchy

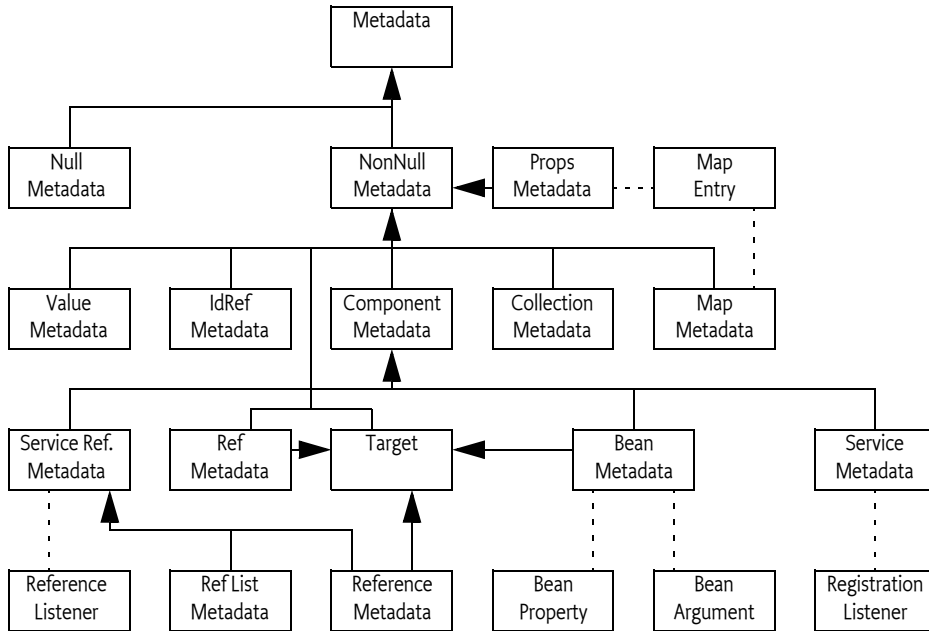

## 121.15 Blueprint XML Schema

The Blueprint schema included in this specification can be found in digital form at [9] *OSGi XML Schemas*.

```

<xsd:schema xmlns="http://www.osgi.org/xmlns/blueprint/v1.0.0"
  xmlns:xsd="http://www.w3.org/2001/XMLSchema" targetNamespace="http://www.osgi.org/xmlns/blueprint/v1.0.0"
  elementFormDefault="qualified" attributeFormDefault="unqualified"
  version="1.0.1">

  <xsd:annotation>
    <xsd:documentation>
      <![CDATA[
        This is the XML Schema for the OSGi Blueprint service 1.0.0
        development descriptor. Blueprint configuration files
        using this schema must indicate the schema using the
        blueprint/v1.0.0 namespace. For example,

        <blueprint xmlns="http://www.osgi.org/xmlns/blueprint/v1.0.0">

          if used as a qualified namespace, "bp" is the recommended
          namespace prefix.

        ]]>
      </xsd:documentation>
    </xsd:annotation>

    <!-- Schema elements for core component declarations -->

    <xsd:complexType name="Tcomponent" abstract="true">
      <xsd:annotation>
        <xsd:documentation>
          <![CDATA[
            The Tcomponent type is the base type for top-level
            Blueprint components. The <bean> <reference>, <service>,
            and <reference-list> elements are all derived from
            the Tcomponent type. This type defines an id attribute
            that is used create references between different components.
            Component elements can also be inlined within other component
            definitions. The id attribute is not valid when inlined.
          ]]>
        </xsd:documentation>
      </xsd:annotation>
    </xsd:complexType>
  
```

```

    ]}]>
  </xsd:documentation>
</xsd:annotation>

<xsd:attribute name="id" type="xsd:ID" />

<xsd:attribute name="activation" type="Tactivation">
  <xsd:annotation>
    <xsd:documentation>
      <![CDATA[
        The activation attribute for this component. This can either
        be "eager" or "lazy". If not specified, it
        defaults to default-activation attribute of the enclosing
        <blueprint> element.
      ]]>
    </xsd:documentation>
  </xsd:annotation>
</xsd:attribute>

<xsd:attribute name="depends-on" type="TdependsOn">
  <xsd:annotation>
    <xsd:documentation>
      <![CDATA[
        depends-on identifies (by id) other components that this component
        depends on. The component only be activated after the
        depends-on components are successfully activated. Also, if there
        are <reference> or <reference-list> elements with unsatisfied
        mandatory references, then the depends-on relationship will also
        be used to determine whether this service is enabled or not.
      ]]>
    </xsd:documentation>
  </xsd:annotation>
</xsd:attribute>
</xsd:complexType>

<xsd:element name="blueprint" type="Tblueprint">
  <xsd:annotation>
    <xsd:documentation>
      <![CDATA[
        The <blueprint> element is the root element for a blueprint
        configuration file. A blueprint configuration has two sections.
        The first section (contained within the <type-converters> element)
        identifies components that are used for converting values into
        different target types. The type converters are optional, so
        the file does not need to specify a type converter section.

        Following the type converters are the component definitions.
        Components are <bean>, <service>, <reference>, and
        <reference-list> elements that identify the bundle components that will
        be managed by the blueprint service.
      ]]>
    </xsd:documentation>
  </xsd:annotation>
</xsd:element>

<xsd:complexType name="Tblueprint">
  <xsd:sequence>
    <xsd:element name="description" type="Tdescription"
      minOccurs="0" />
    <xsd:element name="type-converters" type="Ttype-converters"
      minOccurs="0" maxOccurs="1" />
    <!-- top-level components -->
    <xsd:choice minOccurs="0" maxOccurs="unbounded">
      <xsd:element name="service" type="Tservice" />
      <xsd:element name="reference-list" type="Treference-list" />
      <xsd:element name="bean" type="Tbean" />
      <xsd:element name="reference" type="Treference" />
      <xsd:any namespace="##other" processContents="lax" />
    </xsd:choice>
  </xsd:sequence>

  <!-- Defaults-->
  <xsd:attribute name="default-activation" default="eager"
    type="Tactivation">
  </xsd:annotation>

```

```

    <xsd:documentation>
      <![CDATA[
        Specifies the default activation setting that will be defined
        for components. If not specified, the global default is "eager".
        Individual components may override the default value.
      ]]>
    </xsd:documentation>
  </xsd:annotation>
</xsd:attribute>
<xsd:attribute name="default-timeout" type="Ttimeout"
  default="300000">
  <xsd:annotation>
    <xsd:documentation>
      <![CDATA[
        Specifies the default timeout value to be used when operations
        are invoked on unsatisfied service references. If the
        reference does not change to a satisfied state within the timeout
        window, an error is raised on the method invocation. The
        default timeout value is 300000 milliseconds and individual
        <reference> element can override the specified configuration
        default.
      ]]>
    </xsd:documentation>
  </xsd:annotation>
</xsd:attribute>
<xsd:attribute name="default-availability" type="Tavailability"
  default="mandatory">
  <xsd:annotation>
    <xsd:documentation>
      <![CDATA[
        Specifies the default availability value to be used for
        <reference>, and <reference-list> components. The
        normal default is "mandatory", and can be changed by individual
        service reference components.
      ]]>
    </xsd:documentation>
  </xsd:annotation>
</xsd:attribute>
<xsd:anyAttribute namespace="##other"
  processContents="lax" />
</xsd:complexType>

<xsd:complexType name="Ttype-converters">
  <xsd:annotation>
    <xsd:documentation>
      <![CDATA[
        The type used for the <type-converters> element. The
        <type-converters> section is a set of <bean>, <ref>, or
        <reference> elements that identify the type converter components.
      ]]>
    </xsd:documentation>
  </xsd:annotation>
  <xsd:choice minOccurs="0" maxOccurs="unbounded">
    <xsd:element name="bean" type="Tbean" />
    <xsd:element name="reference" type="Treference" />
    <xsd:element name="ref" type="Tref" />
    <xsd:any namespace="##other" processContents="lax" />
  </xsd:choice>
</xsd:complexType>

<!--
  Components that provide a reasonable target for injection used for
  listeners, etc.
-->

<xsd:group name="GtargetComponent">
  <xsd:annotation>
    <xsd:documentation>
      <![CDATA[
        A target component is one that can be a target for a
        listener, registration-listener or service elements.
        This is used in contexts where the requirement is a single
        provided object that will implement a particular interface.
        The provided object is obtained either from a <ref> element
        or an inlined <bean> or <reference>.
      ]]>
    </xsd:documentation>
  </xsd:annotation>

```

```

    ]]>
  </xsd:documentation>
</xsd:annotation>
<xsd:choice>
  <xsd:element name="bean" type="Tinlined-bean" />
  <xsd:element name="reference" type="Tinlined-reference" />
  <xsd:element name="ref" type="Tref" />
  <xsd:any namespace="##other" processContents="lax" />
</xsd:choice>
</xsd:group>

<xsd:group name="GallComponents">
  <xsd:annotation>
    <xsd:documentation>
      <![CDATA[
        An all components is used in contexts where all component element
        types are values. The set of component elements contains
        <bean>, <service>, <reference>, <reference-list> and <ref>.
      ]]>
    </xsd:documentation>
  </xsd:annotation>
  <xsd:choice>
    <xsd:element name="service" type="Tinlined-service" />
    <xsd:element name="reference-list" type="Tinlined-reference-list" />
    <xsd:group ref="GtargetComponent" />
  </xsd:choice>
</xsd:group>

<xsd:group name="GbeanElements">
  <xsd:annotation>
    <xsd:documentation>
      <![CDATA[
        A bean elements is a reusable definition of the elements allowed on
        a <bean> element.
      ]]>
    </xsd:documentation>
  </xsd:annotation>
  <xsd:sequence>
    <xsd:element name="description" type="Tdescription"
      minOccurs="0" />
    <xsd:choice minOccurs="0" maxOccurs="unbounded">
      <xsd:element name="argument" type="Targument" />
      <xsd:element name="property" type="Tproperty" />
      <xsd:any namespace="##other" processContents="lax" />
    </xsd:choice>
  </xsd:sequence>
</xsd:group>

<xsd:complexType name="Tbean">
  <xsd:annotation>
    <xsd:documentation>
      <![CDATA[
        The type definition for a <bean> component. The <bean>
        attributes provide the characteristics for how to create a
        bean instance. Constructor arguments and injected properties
        are specified via child <argument> and <property> elements.
      ]]>
    </xsd:documentation>
  </xsd:annotation>
  <xsd:complexContent>
    <xsd:extension base="Tcomponent">
      <xsd:group ref="GbeanElements" />
      <xsd:attribute name="class" type="Tclass" />
      <xsd:attribute name="init-method" type="Tmethod" />
      <xsd:attribute name="destroy-method" type="Tmethod" />
      <xsd:attribute name="factory-method" type="Tmethod" />
      <xsd:attribute name="factory-ref" type="Tidref" />
      <xsd:attribute name="scope" type="Tscope" />
      <xsd:anyAttribute namespace="##other"
        processContents="lax" />
    </xsd:extension>
  </xsd:complexContent>
</xsd:complexType>

<xsd:complexType name="Tinlined-bean">

```

```

<xsd:annotation>
  <xsd:documentation>
    <![CDATA[
      The Tinline-bean type is used for inlined (i.e. non top level)
      <bean> elements. Those elements have some restrictions on
      the attributes that can be used to define them.
    ]]>
  </xsd:documentation>
</xsd:annotation>
<xsd:complexContent>
  <xsd:restriction base="Tbean">
    <xsd:group ref="GbeanElements" />
    <xsd:attribute name="id" use="prohibited" />
    <xsd:attribute name="depends-on" type="TdependsOn" />
    <xsd:attribute name="activation" use="prohibited"
      fixed="lazy" />
    <xsd:attribute name="class" type="Tclass" />
    <xsd:attribute name="init-method" type="Tmethod" />
    <xsd:attribute name="destroy-method" use="prohibited" />
    <xsd:attribute name="factory-method" type="Tmethod" />
    <xsd:attribute name="factory-ref" type="Tidref" />
    <xsd:attribute name="scope" use="prohibited" />
    <xsd:anyAttribute namespace="##other"
      processContents="lax" />
  </xsd:restriction>
</xsd:complexContent>
</xsd:complexType>

<xsd:complexType name="Targument">
  <xsd:annotation>
    <xsd:documentation>
      <![CDATA[
        An argument used to create an object defined by a <bean>
        component. The <argument> elements are the arguments for the
        bean class constructor or passed to the bean factory method.

        The type, if specified, is used to disambiguate the constructor
        or method signature. Arguments may also be matched up with
        arguments by explicitly specifying the index position. If the
        index is used, then all <argument> elements for the bean must
        also specify the index.

        The value and ref attributes are convenience shortcuts to make
        the <argument> tag easier to code. A fuller set of injected
        values and types can be specified using one of the "value"
        type elements.
      ]]>
    </xsd:documentation>
  </xsd:annotation>
  <xsd:sequence>
    <xsd:element name="description" type="Tdescription"
      minOccurs="0" />
    <xsd:group ref="Gvalue" minOccurs="0" />
  </xsd:sequence>
  <xsd:attribute name="index" type="xsd:nonNegativeInteger" />
  <xsd:attribute name="type" type="Ttype" />
  <xsd:attribute name="ref" type="Tidref" />
  <xsd:attribute name="value" type="TstringValue" />
</xsd:complexType>

<xsd:complexType name="Tproperty">
  <xsd:annotation>
    <xsd:documentation>
      <![CDATA[
        A property that will be injected into a created <bean>
        component. The <property> elements correspond to named
        JavaBean setting methods for a created bean object.

        The value and ref attributes are convenience shortcuts to make
        the <argument> tag easier to code. A fuller set of injected
        values and types can be specified using one of the "value"
        type elements.
      ]]>
    </xsd:documentation>
  </xsd:annotation>

```



```

    <xsd:sequence>
      <xsd:element name="description" type="Tdescription"
        minOccurs="0" />
      <xsd:group ref="Gvalue" minOccurs="0" />
    </xsd:sequence>
    <xsd:attribute name="name" type="Tmethod" use="required" />
    <xsd:attribute name="ref" type="Tidref" />
    <xsd:attribute name="value" type="TstringValue" />
  </xsd:complexType>

<xsd:complexType name="Tkey">
  <xsd:annotation>
    <xsd:documentation>
      <![CDATA[
        The Tkey type defines the element types that are permitted
        for Map key situations. These can be any of the "value"
        types other than the <null> element.
      ]]>
    </xsd:documentation>
  </xsd:annotation>
  <xsd:group ref="Gnonnullvalue" />
</xsd:complexType>

<!-- reference -->
<xsd:complexType name="Treference">
  <xsd:annotation>
    <xsd:documentation>
      <![CDATA[
        The Treference type defines the <reference> element. These
        are instances of the TserviceReference type, with the addition
        of a timeout attribute. If the timeout is not specified,
        the default-timeout value is inherited from the encapsulating
        <blueprint> definition.
      ]]>
    </xsd:documentation>
  </xsd:annotation>
  <xsd:complexContent>
    <xsd:extension base="TserviceReference">
      <xsd:sequence>
        <xsd:any namespace="##other" minOccurs="0" maxOccurs="unbounded"
          processContents="lax" />
      </xsd:sequence>
      <xsd:attribute name="timeout" type="Ttimeout" />
    </xsd:extension>
  </xsd:complexContent>
</xsd:complexType>

<xsd:complexType name="Tinlined-reference">
  <xsd:annotation>
    <xsd:documentation>
      <![CDATA[
        The Tinlined-reference type is used for inlined (i.e. non top level)
        <reference> elements.
      ]]>
    </xsd:documentation>
  </xsd:annotation>
  <xsd:complexContent>
    <xsd:restriction base="Treference">
      <xsd:sequence>
        <xsd:group ref="GserviceReferenceElements" />
        <xsd:any namespace="##other" minOccurs="0" maxOccurs="unbounded"
          processContents="lax" />
      </xsd:sequence>
      <xsd:attribute name="id" use="prohibited" />
      <xsd:attribute name="depends-on" type="TdependsOn" />
      <xsd:attribute name="activation" use="prohibited"
        fixed="lazy" />
      <xsd:attribute name="interface" type="Tclass" />
      <xsd:attribute name="filter" type="xsd:normalizedString" />
      <xsd:attribute name="component-name" type="Tidref" />
      <xsd:attribute name="availability" type="Tavailability" />
      <xsd:attribute name="timeout" type="Ttimeout" />
      <xsd:anyAttribute namespace="##other"
        processContents="lax" />
    </xsd:restriction>
  </xsd:complexContent>

```

```

    </xsd:complexContent>
  </xsd:complexType>

  <!-- reference-list -->
  <xsd:complexType name="Treference-list">
    <xsd:annotation>
      <xsd:documentation>
        <![CDATA[
          The Treference-list builds in the characteristics of the
          TserviceReference type to define characteristics of the
          <reference-list>. This adds in the characteristics that
          only apply to collections of references (e.g., member-type).
        ]]>
      </xsd:documentation>
    </xsd:annotation>
    <xsd:complexContent>
      <xsd:extension base="TserviceReference">
        <xsd:sequence>
          <xsd:any namespace="##other" minOccurs="0" maxOccurs="unbounded"
            processContents="lax" />
        </xsd:sequence>
        <xsd:attribute name="member-type" type="Tservice-use"
          default="service-object">
        </xsd:attribute>
      </xsd:extension>
    </xsd:complexContent>
  </xsd:complexType>

  <xsd:complexType name="Tinlined-reference-list">
    <xsd:annotation>
      <xsd:documentation>
        <![CDATA[
          The Tinlined-reference-list type is used for inlined (i.e. non top level)
          <reference-list> elements.
        ]]>
      </xsd:documentation>
    </xsd:annotation>
    <xsd:complexContent>
      <xsd:restriction base="Treference-list">
        <xsd:sequence>
          <xsd:group ref="GserviceReferenceElements" />
          <xsd:any namespace="##other" minOccurs="0" maxOccurs="unbounded"
            processContents="lax" />
        </xsd:sequence>
        <xsd:attribute name="id" use="prohibited" />
        <xsd:attribute name="depends-on" type="TdependsOn" />
        <xsd:attribute name="activation" use="prohibited"
          fixed="lazy" />
        <xsd:attribute name="interface" type="Tclass" />
        <xsd:attribute name="filter" type="xsd:normalizedString" />
        <xsd:attribute name="component-name" type="Tidref" />
        <xsd:attribute name="availability" type="Tavailability" />
        <xsd:attribute name="member-type" type="Tservice-use"
          default="service-object" />
        <xsd:anyAttribute namespace="##other"
          processContents="lax" />
      </xsd:restriction>
    </xsd:complexContent>
  </xsd:complexType>

  <!-- Reference base class -->
  <xsd:complexType name="TserviceReference">
    <xsd:annotation>
      <xsd:documentation>
        <![CDATA[
          TserviceReference is the base element type used for <reference>
          and <reference-list> elements. This type defines all of the
          characteristics common to both sorts of references.
        ]]>
      </xsd:documentation>
    </xsd:annotation>
    <xsd:complexContent>
      <xsd:extension base="Tcomponent">
        <xsd:sequence>
          <xsd:group ref="GserviceReferenceElements" />

```

```

</xsd:sequence>

<xsd:attribute name="interface" type="Tclass">
  <xsd:annotation>
    <xsd:documentation>
      <![CDATA[
        The interface that the OSGi service must implement and that will be
        implemented by the proxy object.
        This attribute is optional.
      ]]>
    </xsd:documentation>
  </xsd:annotation>
</xsd:attribute>
<xsd:attribute name="filter" type="xsd:normalizedString">
  <xsd:annotation>
    <xsd:documentation>
      <![CDATA[
        A filter string used to narrow the search for a matching service
        reference.
      ]]>
    </xsd:documentation>
  </xsd:annotation>
</xsd:attribute>
<xsd:attribute name="component-name" type="Tidref">
  <xsd:annotation>
    <xsd:documentation>
      <![CDATA[
        An optional specifier that can be used to match a service definition
        to one created by a specific blueprint component.
      ]]>
    </xsd:documentation>
  </xsd:annotation>
</xsd:attribute>
<xsd:attribute name="availability" type="Tavailability">
  <xsd:annotation>
    <xsd:documentation>
      <![CDATA[
        Use to control the initial processing of service references at
        blueprint context startup. "mandatory" indicates the context
        should not start unless the service is available within the
        specified context startup period. "optional" indicates availability
        of this service is not a requirement at bundle startup.

        NOTE: No default is specified because this can be overridden
        by the default-availability attribute of the <blueprint> element.
      ]]>
    </xsd:documentation>
  </xsd:annotation>
</xsd:attribute>
<xsd:anyAttribute namespace="##other"
  processContents="lax" />
</xsd:extension>
</xsd:complexContent>
</xsd:complexType>

<xsd:group name="GserviceReferenceElements">
  <xsd:sequence>
    <xsd:element name="description" type="Tdescription"
      minOccurs="0" />
    <!-- listener -->
    <xsd:element name="reference-listener" type="TreferenceListener"
      minOccurs="0" maxOccurs="unbounded">
      <xsd:annotation>
        <xsd:documentation>
          <![CDATA[
            A definition of a listener that will watch for bind/unbind events
            associated with the service reference. The targetted listener can
            be a <ref> to a <bean> or <reference> element, or an inline
            <bean> or <reference>.
          ]]>
        </xsd:documentation>
      </xsd:annotation>
    </xsd:element>
  </xsd:sequence>
</xsd:group>

```

```

<xsd:complexType name="TreferenceListener">
  <xsd:annotation>
    <xsd:documentation>
      <![CDATA[
        TreferenceListener defines a reference listener that is attached
        to a <reference> or <reference-list> element. The listener
        object can be specified as a <ref> or as an inline <bean> or
        <reference> component. Listener events are mapped to the indicated
        bind or unbind methods.
      ]]>
    </xsd:documentation>
  </xsd:annotation>
  <xsd:sequence>
    <xsd:group ref="GtargetComponent" minOccurs="0" />
  </xsd:sequence>
  <xsd:attribute name="ref" type="Tidref" />
  <xsd:attribute name="bind-method" type="Tmethod" />
  <xsd:attribute name="unbind-method" type="Tmethod" />
</xsd:complexType>

<xsd:simpleType name="Tactivation">
  <xsd:annotation>
    <xsd:documentation>
      <![CDATA[
        Tactivation defines the activation type for components. This is used in this
        schema by the <blueprint> default-activation attribute and the
        activation attribute.
      ]]>
    </xsd:documentation>
  </xsd:annotation>
  <xsd:restriction base="xsd:NMTOKEN">
    <xsd:enumeration value="eager" />
    <xsd:enumeration value="lazy" />
  </xsd:restriction>
</xsd:simpleType>

<xsd:simpleType name="Tavailability">
  <xsd:annotation>
    <xsd:documentation>
      <![CDATA[
        Tavailability defines an availability attribute type. This is used in this
        schema by the <blueprint> default-availability attribute and the
        <reference> and <reference-list> availability attribute.
      ]]>
    </xsd:documentation>
  </xsd:annotation>
  <xsd:restriction base="xsd:NMTOKEN">
    <xsd:enumeration value="mandatory" />
    <xsd:enumeration value="optional" />
  </xsd:restriction>
</xsd:simpleType>

<!-- service -->

<xsd:complexType name="Tservice">
  <xsd:annotation>
    <xsd:documentation>
      <![CDATA[
        Tservice is the type for services exported by this blueprint bundle.
        Services are sourced by either a <ref> to a <bean> component or an
        <inline> bean component.
      ]]>
    </xsd:documentation>
  </xsd:annotation>
  <xsd:complexContent>
    <xsd:extension base="Tcomponent">
      <xsd:sequence>
        <xsd:group ref="GserviceElements" />
      </xsd:sequence>
      <xsd:attribute name="interface" type="Tclass">
        <xsd:annotation>
          <xsd:documentation>
            <![CDATA[
              The interface that this OSGi service will provide.
            ]]>
          </xsd:documentation>
        </xsd:annotation>
      </xsd:attribute>
    </xsd:extension>
  </xsd:complexContent>
</xsd:complexType>

```

```

    ]]>
    </xsd:documentation>
  </xsd:annotation>
</xsd:attribute>
<xsd:attribute name="ref" type="Tidref">
  <xsd:annotation>
    <xsd:documentation>
      <![CDATA[
        The ref attribute can be used to specify the component that provides
        the object exported as an OSGi service.
      ]]>
    </xsd:documentation>
  </xsd:annotation>
</xsd:attribute>
<xsd:attribute name="auto-export" type="TautoExportModes"
  default="disabled">
  <xsd:annotation>
    <xsd:documentation>
      <![CDATA[
        If set to a value different from "disabled", the Blueprint Container
        will introspect the target to discover the set of interfaces or classes
        that the service will be registered under.
      ]]>
    </xsd:documentation>
  </xsd:annotation>
</xsd:attribute>
<xsd:attribute name="ranking" type="xsd:int" default="0">
  <xsd:annotation>
    <xsd:documentation>
      <![CDATA[
        A service ranking value that is added to the service properties
        the service will be published with.
      ]]>
    </xsd:documentation>
  </xsd:annotation>
</xsd:attribute>
<xsd:anyAttribute namespace="##other"
  processContents="lax" />
</xsd:extension>
</xsd:complexContent>
</xsd:complexType>

<xsd:complexType name="Tinlined-service">
  <xsd:annotation>
    <xsd:documentation>
      <![CDATA[
        The Tinlined-service type is used for inlined (i.e. non top level)
        <service> elements.
      ]]>
    </xsd:documentation>
  </xsd:annotation>
  <xsd:complexContent>
    <xsd:restriction base="Tservice">
      <xsd:sequence>
        <xsd:group ref="GserviceElements" />
      </xsd:sequence>
      <xsd:attribute name="id" use="prohibited" />
      <xsd:attribute name="depends-on" type="TdependsOn" />
      <xsd:attribute name="activation" use="prohibited"
        fixed="lazy" />
      <xsd:attribute name="interface" type="Tclass" />
      <xsd:attribute name="ref" type="Tidref" />
      <xsd:attribute name="auto-export" type="TautoExportModes"
        default="disabled" />
      <xsd:attribute name="ranking" type="xsd:int" default="0" />
      <xsd:anyAttribute namespace="##other"
        processContents="lax" />
    </xsd:restriction>
  </xsd:complexContent>
</xsd:complexType>

<xsd:group name="GbaseServiceElements">
  <xsd:sequence>
    <xsd:element name="description" type="Tdescription"
      minOccurs="0" />

```

```

<xsd:element name="interfaces" type="Tinterfaces"
  minOccurs="0">
  <xsd:annotation>
    <xsd:documentation>
      <![CDATA[
        A collection of one or more interface class names this service
        will be registered under. The <service> element also has
        a shortcut interface attribute for the usual case of just
        a single interface being used. This also cannot be used if
        the auto-export attribute is used.
      ]]>
    </xsd:documentation>
  </xsd:annotation>
</xsd:element>

<xsd:element name="service-properties" type="TserviceProperties"
  minOccurs="0">
  <xsd:annotation>
    <xsd:documentation>
      <![CDATA[
        The service provided when the service is registered. The service
        properties are similar to map elements, but the keys must always
        be strings, and the values are required to be in a narrower range.
      ]]>
    </xsd:documentation>
  </xsd:annotation>
</xsd:element>
<xsd:element name="registration-listener" type="TregistrationListener"
  minOccurs="0" maxOccurs="unbounded">
  <xsd:annotation>
    <xsd:documentation>
      <![CDATA[
        A set of 0 or more registration listeners attached to this service
        component. The registration listeners will be notified whenever the
        service is registered or unregistered from the framework service
        registry.
      ]]>
    </xsd:documentation>
  </xsd:annotation>
</xsd:element>
</xsd:sequence>
</xsd:group>

<xsd:group name="GserviceElements">
  <xsd:annotation>
    <xsd:documentation>
      <![CDATA[
        A set of service elements.
      ]]>
    </xsd:documentation>
  </xsd:annotation>
  <xsd:sequence>
    <xsd:group ref="GbaseServiceElements" />
    <xsd:group ref="GtargetComponent" minOccurs="0">
      <xsd:annotation>
        <xsd:documentation>
          <![CDATA[
            A service definition can use any of the target types as an inline element
            as well.
          ]]>
        </xsd:documentation>
      </xsd:annotation>
    </xsd:group>
  </xsd:sequence>
</xsd:group>

<xsd:complexType name="TregistrationListener">
  <xsd:annotation>
    <xsd:documentation>
      <![CDATA[
        A registration listener definition. The target registration listener
        can be either a <ref> to a <bean> or <service> component, or an inline
        <bean> or <service> component definition. The registration-method and
        unregistration-method attributes define the methods that will be called
        for the respective events.
      ]]>
    </xsd:documentation>
  </xsd:annotation>

```

```

        For the very common case of using a <ref> to a listener component, the
        ref attribute may also be used as a shortcut.
    ]]>
</xsd:documentation>
</xsd:annotation>
<xsd:sequence>
  <xsd:group ref="GtargetComponent" minOccurs="0" />
</xsd:sequence>
<xsd:attribute name="ref" type="Tidref" />
<xsd:attribute name="registration-method" type="Tmethod" />
<xsd:attribute name="unregistration-method" type="Tmethod" />
</xsd:complexType>

<!-- Values -->

<xsd:group name="Gvalue">
  <xsd:annotation>
    <xsd:documentation>
      <![CDATA[
        The set of "value" types that can be used in any place a value
        can be specified. This set includes the <ref> and <idref> elements, any of the
        component types (<bean>, <service>, etc.) as inline components, the
        generic <value> element for types sourced from string values, any of the
        collection types (<set>, <list>, <array>, <map>, <props>), and the
        <null> type to inject a null value.
      ]]>
    </xsd:documentation>
  </xsd:annotation>
  <xsd:choice>
    <xsd:group ref="GnonNullValue" />
    <xsd:element name="null" type="Tnull" />
  </xsd:choice>
</xsd:group>

<xsd:complexType name="Tnull">
  <xsd:annotation>
    <xsd:documentation>
      <![CDATA[
        The definition for a <null> value type.
      ]]>
    </xsd:documentation>
  </xsd:annotation>
</xsd:complexType>

<xsd:group name="GnonNullValue">
  <xsd:annotation>
    <xsd:documentation>
      <![CDATA[
        The set of "value" types that can be used in any place a non-null value
        can be specified. This set includes the <ref> and <idref> elements, any of the
        component types (<bean>, <service>, etc.) as inline components, the
        generic <value> element for types sourced from string values, and any of the
        collection types (<set>, <list>, <array>, <map>, <props>).

        The <null> type is NOT a member of this group.
      ]]>
    </xsd:documentation>
  </xsd:annotation>
  <xsd:choice>
    <xsd:group ref="GallComponents" />
    <xsd:element name="idref" type="Tref" />
    <xsd:element name="value" type="Tvalue" />
    <xsd:element name="list" type="Tcollection" />
    <xsd:element name="set" type="Tcollection" />
    <xsd:element name="map" type="Tmap" />
    <xsd:element name="array" type="Tcollection" />
    <xsd:element name="props" type="Tprops" />
  </xsd:choice>
</xsd:group>

<xsd:complexType name="Tref">
  <xsd:annotation>
    <xsd:documentation>
      <![CDATA[

```

```

        Tref is the type used for <ref> elements. This specifies a required
        component id for the reference component.
    ]]>
</xsd:documentation>
</xsd:annotation>
<xsd:attribute name="component-id" type="Tidref" use="required" />
</xsd:complexType>

<xsd:complexType name="Tvalue" mixed="true">
  <xsd:annotation>
    <xsd:documentation>
      <![CDATA[
        Tvalue is the type used for <value> elements. The <value> element
        is used for types that can be created from a single string value.
        The string value is the data value for the element. The optional
        type attribute allows a target conversion value to be explicitly
        specified.
      ]]>
    </xsd:documentation>
  </xsd:annotation>
  <xsd:attribute name="type" type="Ttype" />
</xsd:complexType>

<!-- Collection Values -->

<xsd:complexType name="TtypedCollection">
  <xsd:annotation>
    <xsd:documentation>
      <![CDATA[
        TtypedCollection defines comment attributes shared among different
        collection types that allow a default value type to be specified.
      ]]>
    </xsd:documentation>
  </xsd:annotation>
  <xsd:attribute name="value-type" type="Ttype" />
</xsd:complexType>

<xsd:complexType name="Tcollection">
  <xsd:annotation>
    <xsd:documentation>
      <![CDATA[
        Tcollection is the base schema type for different ordered collection
        types. This is shared between the <array>, <list>, and <set> elements.
      ]]>
    </xsd:documentation>
  </xsd:annotation>
  <xsd:complexContent>
    <xsd:extension base="TtypedCollection">
      <xsd:group ref="Gvalue" minOccurs="0" maxOccurs="unbounded" />
    </xsd:extension>
  </xsd:complexContent>
</xsd:complexType>

<xsd:complexType name="Tprops">
  <xsd:annotation>
    <xsd:documentation>
      <![CDATA[
        Tprops is the type used by the <props> value element. The prop elements
        are pairs of string-valued keys and values.
      ]]>
    </xsd:documentation>
  </xsd:annotation>
  <xsd:sequence>
    <xsd:element name="prop" type="Tprop" minOccurs="0"
      maxOccurs="unbounded" />
  </xsd:sequence>
</xsd:complexType>

<xsd:complexType name="Tprop" mixed="true">
  <xsd:annotation>
    <xsd:documentation>
      <![CDATA[
        Tprop is a single property element for a <props> value type. The property
        value can be specified using either the attribute, or as value data for
        the property element.
      ]]>
    </xsd:documentation>
  </xsd:annotation>

```



```

    ]]>
  </xsd:documentation>
</xsd:annotation>
<xsd:attribute name="key" type="TstringValue" use="required" />
<xsd:attribute name="value" type="TstringValue" />
</xsd:complexType>

<!-- 'map' element type -->
<xsd:complexType name="Tmap">
  <xsd:annotation>
    <xsd:documentation>
      <![CDATA[
        Tmap is the base type used for <map> elements. A map may have a
        default value type specified, so it inherits from the TtypeCollection
        type. A key type can also be specified, and the map members are
        created from the entry elements, which require a key/value pair.
      ]]>
    </xsd:documentation>
  </xsd:annotation>
  <xsd:complexContent>
    <xsd:extension base="TtypedCollection">
      <xsd:sequence>
        <xsd:element name="entry" type="TmapEntry" minOccurs="0"
          maxOccurs="unbounded" />
      </xsd:sequence>
      <xsd:attribute name="key-type" type="Ttype" />
    </xsd:extension>
  </xsd:complexContent>
</xsd:complexType>

<!-- 'entry' element type -->
<xsd:complexType name="TmapEntry">
  <xsd:annotation>
    <xsd:documentation>
      <![CDATA[
        TmapEntry is used for <entry> elements nested inside of a <map> element.
        Each <entry> instance defines a key/value pair that will be added to the
        Map. Both the keys and values may be arbitrary types. Keys must not
        be <null> but <null> is permitted for entry values. A default type
        can be specified for both the keys and the values, but individual keys
        or values can override the default.
      ]]>
    </xsd:documentation>
  </xsd:annotation>
  <xsd:sequence>
    <xsd:element name="key" type="Tkey" minOccurs="0" />
    <xsd:group ref="Gvalue" minOccurs="0" />
  </xsd:sequence>
  <xsd:attribute name="key" type="TstringValue" />
  <xsd:attribute name="key-ref" type="Tidref" />
  <xsd:attribute name="value" type="TstringValue" />
  <xsd:attribute name="value-ref" type="Tidref" />
</xsd:complexType>

<!-- 'service property' element type -->
<xsd:complexType name="TserviceProperties">
  <xsd:annotation>
    <xsd:documentation>
      <![CDATA[
        TserviceProperty is used for <service-properties> elements.
        The syntax is similar to what is defined for <map>, but keys must be
        string values and there are no type defaults that can be specified.
        created from the entry elements, which require a key/value pair.
      ]]>
    </xsd:documentation>
  </xsd:annotation>
  <xsd:sequence>
    <xsd:element name="entry" type="TservicePropertyEntry"
      minOccurs="0" maxOccurs="unbounded" />
    <xsd:any namespace="##other" processContents="lax"
      minOccurs="0" maxOccurs="unbounded" />
  </xsd:sequence>
</xsd:complexType>

<!-- 'entry' element type -->

```

```

<xsd:complexType name="TservicePropertyEntry">
  <xsd:annotation>
    <xsd:documentation>
      <![CDATA[
        TservicePropertyEntry is an entry value used for the <service-properties>
        element. This does not allow a child <key> element and there are no
        key-ref or value-ref attributes.
      ]]>
    </xsd:documentation>
  </xsd:annotation>
  <xsd:sequence>
    <xsd:group ref="Gvalue" minOccurs="0" />
  </xsd:sequence>
  <xsd:attribute name="key" type="TstringValue" use="required" />
  <xsd:attribute name="value" type="TstringValue" />
</xsd:complexType>

<!-- General types -->

<xsd:complexType name="Tdescription" mixed="true">
  <xsd:annotation>
    <xsd:documentation>
      <![CDATA[
        A generic <description> element type to allow documentation to added to the
        blueprint configuration.
      ]]>
    </xsd:documentation>
  </xsd:annotation>
  <xsd:choice minOccurs="0" maxOccurs="unbounded" />
</xsd:complexType>

<xsd:complexType name="Tinterfaces">
  <xsd:annotation>
    <xsd:documentation>
      <![CDATA[
        The type definition for the <interfaces> element used for <service>
      ]]>
    </xsd:documentation>
  </xsd:annotation>
  <xsd:choice minOccurs="1" maxOccurs="unbounded">
    <xsd:element name="value" type="TinterfaceValue" />
  </xsd:choice>
</xsd:complexType>

<xsd:simpleType name="TinterfaceValue">
  <xsd:annotation>
    <xsd:documentation>
      <![CDATA[
        TinterfaceValue is used for subelements of the <interfaces> element.
        This is just a <value>xxxxx</value> element where the contained
        value is the name of an interface class.
      ]]>
    </xsd:documentation>
  </xsd:annotation>
  <xsd:restriction base="Tclass" />
</xsd:simpleType>

<xsd:simpleType name="Tclass">
  <xsd:annotation>
    <xsd:documentation>
      <![CDATA[
        Tclass is a base type that should be used for all attributes that
        refer to java class names.
      ]]>
    </xsd:documentation>
  </xsd:annotation>
  <xsd:restriction base="xsd:NCName" />
</xsd:simpleType>

<xsd:simpleType name="Ttype">
  <xsd:annotation>
    <xsd:documentation>
      <![CDATA[
        Ttype is a base type that refer to java types such as classes or
        arrays.
      ]]>
    </xsd:documentation>
  </xsd:annotation>
  <xsd:restriction base="xsd:string" />
</xsd:simpleType>

```

```

    ]]>
  </xsd:documentation>
</xsd:annotation>
<xsd:restriction base="xsd:token">
  <xsd:pattern value="[\\i-[:]]+[\\c-[:]]*(\\[\\])*" />
</xsd:restriction>
</xsd:simpleType>

<xsd:simpleType name="Tmethod">
  <xsd:annotation>
    <xsd:documentation>
      <![CDATA[
        Tmethod is a base type that should be used for all attributes that
        refer to java method names.
      ]]>
    </xsd:documentation>
  </xsd:annotation>
  <xsd:restriction base="xsd:NCName" />
</xsd:simpleType>

<!--
  Should be used for all attributes and elements that refer to method
  names
-->
<xsd:simpleType name="Tidref">
  <xsd:annotation>
    <xsd:documentation>
      <![CDATA[
        Tidref is a base type that should be used for all attributes that
        refer to component ids.
      ]]>
    </xsd:documentation>
  </xsd:annotation>
  <xsd:restriction base="xsd:NCName" />
</xsd:simpleType>

<xsd:simpleType name="TstringValue">
  <xsd:annotation>
    <xsd:documentation>
      <![CDATA[
        TstringValue is a base type that should be used for all attributes that
        refer to raw string values
      ]]>
    </xsd:documentation>
  </xsd:annotation>
  <xsd:restriction base="xsd:normalizedString" />
</xsd:simpleType>

<xsd:simpleType name="TautoExportModes">
  <xsd:annotation>
    <xsd:documentation>
      <![CDATA[
        TautoExportModes is a base type that should be used for export-mode
        attributes.
      ]]>
    </xsd:documentation>
  </xsd:annotation>
  <xsd:restriction base="xsd:NMTOKEN">
    <xsd:enumeration value="disabled" />
    <xsd:enumeration value="interfaces" />
    <xsd:enumeration value="class-hierarchy" />
    <xsd:enumeration value="all-classes" />
  </xsd:restriction>
</xsd:simpleType>

<xsd:simpleType name="Ttimeout">
  <xsd:annotation>
    <xsd:documentation>
      <![CDATA[
        Ttimeout is a base type that should be used for all attributes that
        specify timeout values
      ]]>
    </xsd:documentation>
  </xsd:annotation>
  <xsd:restriction base="xsd:unsignedLong" />

```

```
</xsd:simpleType>

<xsd:simpleType name="TdependsOn">
  <xsd:annotation>
    <xsd:documentation>
      <![CDATA[
        TdependsOn is a base type that should be used for all attributes that
        specify depends-on relationships
      ]]>
    </xsd:documentation>
  </xsd:annotation>
  <xsd:restriction>
    <xsd:simpleType>
      <xsd:list itemType="Tidref" />
    </xsd:simpleType>
    <xsd:minLength value="1" />
  </xsd:restriction>
</xsd:simpleType>

<xsd:simpleType name="Tscope">
  <xsd:union>
    <xsd:simpleType>
      <xsd:restriction base="xsd:NMTOKEN">
        <xsd:enumeration value="singleton" />
        <xsd:enumeration value="prototype" />
      </xsd:restriction>
    </xsd:simpleType>
    <xsd:simpleType>
      <xsd:restriction base="xsd:QName">
        <xsd:pattern value=".+\.+" />
      </xsd:restriction>
    </xsd:simpleType>
  </xsd:union>
</xsd:simpleType>

<xsd:simpleType name="Tservice-use">
  <xsd:annotation>
    <xsd:documentation>
      <![CDATA[
        Indicates the type of object that will be placed within the
        reference collection. "service-object" indicates the
        collection contains blueprint proxies for imported services.
        "service-reference" indicates the collection contains
        ServiceReference objects matching the target service type.
      ]]>
    </xsd:documentation>
  </xsd:annotation>
  <xsd:restriction base="xsd:NMTOKEN">
    <xsd:enumeration value="service-object" />
    <xsd:enumeration value="service-reference" />
  </xsd:restriction>
</xsd:simpleType>

</xsd:schema>
```

## 121.16 Security

### 121.16.1 Blueprint Extender

A Blueprint Extender must use the Bundle Context of the Blueprint bundle. This will ensure that much of the resources allocated will be used on behalf of the Blueprint bundle. However, most Java 2 permissions will also verify the stack and this will inevitably include the Blueprint extender's code. Therefore, the Blueprint extender will require the combined set of permissions needed by all Blueprint bundles. It is therefore likely that in practical situations the Blueprint extender requires All Permission.

The Blueprint bundle requires permission for all actions that are done by the Blueprint Container on behalf of this bundle. That is, the Blueprint Container must not give any extra permissions to the Blueprint bundle because it is being extended.

A Blueprint Container must therefore use a `doPrivileged` block around all actions that execute code on behalf of the Blueprint bundle. This `doPrivileged` block must use an Access Control Context that represents the permissions of the Blueprint bundle.

For example, if a Blueprint bundle defines the following bean:

```
<bean class="java.lang.System" factory-method="exit">
    <argument value="1"/>
</bean>
```

Then the Blueprint bundle must have the proper permission to exit the system or the Blueprint bundle must fail when the bean is constructed. At the same time, a Blueprint bundle must not be required to have any permission needed by the Blueprint Container to perform its tasks.

A Blueprint Container must never use the `setAccessibility` method on a returned member. Only publicly accessible members must be used. Using a non-publicly accessible member must initiate failure, resulting in the destruction of the container.

### 121.16.2 Blueprint Bundle

A Blueprint Bundle must have all the permissions required by its code. There is one additional permission required for the Blueprint Bundle. The Blueprint extender will register a Blueprint Container service on behalf of the Blueprint bundle, and the Blueprint bundle must therefore have:

```
ServicePermission(...BlueprintContainer, [REGISTER])
```

## 121.17 org.osgi.service.blueprint.container

Blueprint Container Package Version 1.0.

This package defines the primary interface to a Blueprint Container, `BlueprintContainer`. An instance of this type is available inside a Blueprint Container as an implicitly defined component with the name "blueprintContainer".

This package also declares the supporting exception types, listener, and constants for working with a Blueprint Container.

Bundles wishing to use this package must list the package in the `Import-Package` header of the bundle's manifest. This package has two types of users: the consumers that use the API in this package and the providers that implement the API in this package.

Example import for consumers using the API in this package:

Import-Package: org.osgi.service.blueprint.container; version="[1.0,2.0)"

Example import for providers implementing the API in this package:

Import-Package: org.osgi.service.blueprint.container; version="[1.0,1.1)"

### 121.17.1 Summary

- `BlueprintContainer` - A Blueprint Container represents the managed state of a Blueprint bundle.
- `BlueprintEvent` - A Blueprint Event.
- `BlueprintListener` - A BlueprintEvent Listener.
- `ComponentDefinitionException` - A Blueprint exception indicating that a component definition is in error.
- `Converter` - Type converter to convert an object to a target type.
- `EventConstants` - Event property names used in Event Admin events published by a Blueprint Container.
- `NoSuchComponentException` - A Blueprint exception indicating that a component does not exist in a Blueprint Container.
- `ReifiedType` - Provides access to a concrete type and its optional generic type parameters.
- `ServiceUnavailableException` - A Blueprint exception indicating that a service is unavailable.

### 121.17.2 public interface `BlueprintContainer`

A Blueprint Container represents the managed state of a Blueprint bundle. A Blueprint Container provides access to all managed components. These are the beans, services, and service references. Only bundles in the ACTIVE state (and also the STARTING state for bundles awaiting lazy activation) can have an associated Blueprint Container. A given Bundle Context has at most one associated Blueprint Container. A Blueprint Container can be obtained by injecting the predefined "blueprint-container" component id. The Blueprint Container is also registered as a service and its managed components can be queried.

*Concurrency* Thread-safe

*Provider Type* Consumers of this API must not implement this type

#### 121.17.2.1 `public Set<String> getComponentIds()`

- Returns the set of component ids managed by this Blueprint Container.

*Returns* An immutable Set of Strings, containing the ids of all of the components managed within this Blueprint Container.

#### 121.17.2.2 `public Object getComponentInstance(String id)`

*id* The component id for the requested component instance.

- Return the component instance for the specified component id. If the component's manager has not yet been activated, calling this operation will atomically activate it. If the component has singleton scope, the activation will cause the component instance to be created and initialized. If the component has prototype scope, then each call to this method will return a new component instance.

*Returns* A component instance for the component with the specified component id.

*Throws* `NoSuchComponentException`– If no component with the specified component id is managed by this Blueprint Container.

#### 121.17.2.3 `public ComponentMetadata getComponentMetadata(String id)`

*id* The component id for the requested Component Metadata.

- Return the Component Metadata object for the component with the specified component id.

*Returns* The Component Metadata object for the component with the specified component id.

*Throws* `NoSuchComponentException`– If no component with the specified component id is managed by this Blueprint Container.

#### 121.17.2.4 **public Collection<T> getMetadata(Class<T> type)**

*Type Arguments* <T extends ComponentMetadata>

<T> Type of Component Metadata.

*type* The super type or type of the requested Component Metadata objects.

- Return all ComponentMetadata objects of the specified Component Metadata type. The supported Component Metadata types are ComponentMetadata (which returns the Component Metadata for all defined manager types), BeanMetadata, ServiceReferenceMetadata (which returns both ReferenceMetadata and ReferenceListMetadata objects), and ServiceMetadata. The collection will include all Component Metadata objects of the requested type, including components that are declared in-line.

*Returns* An immutable collection of Component Metadata objects of the specified type.

#### 121.17.3 **public class BlueprintEvent**

A Blueprint Event.

BlueprintEvent objects are delivered to all registered BlueprintListener services. Blueprint Events must be asynchronously delivered in chronological order with respect to each listener.

In addition, after a Blueprint Listener is registered, the Blueprint extender will synchronously send to this Blueprint Listener the last Blueprint Event for each ready Blueprint bundle managed by this extender. This *replay* of Blueprint Events is designed so that the new Blueprint Listener can be informed of the state of each Blueprint bundle. Blueprint Events sent during this replay will have the `isReplay()` flag set. The Blueprint extender must ensure that this replay phase does not interfere with new Blueprint Events so that the chronological order of all Blueprint Events received by the Blueprint Listener is preserved. If the last Blueprint Event for a given Blueprint bundle is DESTROYED, the extender must not send it during this replay phase.

A type code is used to identify the type of event. The following event types are defined:

- CREATING
- CREATED
- DESTROYING
- DESTROYED
- FAILURE
- GRACE\_PERIOD
- WAITING

In addition to calling the registered BlueprintListener services, the Blueprint extender must also send those events to the Event Admin service, if it is available.

*See Also* BlueprintListener, EventConstants

*Concurrency* Immutable

##### 121.17.3.1 **public static final int CREATED = 2**

The Blueprint extender has created a Blueprint Container for the bundle. This event is sent after the Blueprint Container has been registered as a service.

##### 121.17.3.2 **public static final int CREATING = 1**

The Blueprint extender has started creating a Blueprint Container for the bundle.

**121.17.3.3 public static final int DESTROYED = 4**

The Blueprint Container for the bundle has been completely destroyed. This event is sent after the Blueprint Container has been unregistered as a service.

**121.17.3.4 public static final int DESTROYING = 3**

The Blueprint extender has started destroying the Blueprint Container for the bundle.

**121.17.3.5 public static final int FAILURE = 5**

The Blueprint Container creation for the bundle has failed. If this event is sent after a timeout in the Grace Period, the `getDependencies()` method must return an array of missing mandatory dependencies. The event must also contain the cause of the failure as a `Throwable` through the `getCause()` method.

**121.17.3.6 public static final int GRACE\_PERIOD = 6**

The Blueprint Container has entered the grace period. The list of missing dependencies must be made available through the `getDependencies()` method. During the grace period, a `GRACE_PERIOD` event is sent each time the set of unsatisfied dependencies changes.

**121.17.3.7 public static final int WAITING = 7**

The Blueprint Container is waiting on the availability of a service to satisfy an invocation on a referenced service. The missing dependency must be made available through the `getDependencies()` method which will return an array containing one filter object as a `String`.

**121.17.3.8 public BlueprintEvent(int type, Bundle bundle, Bundle extenderBundle)**

*type* The type of this event.

*bundle* The Blueprint bundle associated with this event. This parameter must not be null.

*extenderBundle* The Blueprint extender bundle that is generating this event. This parameter must not be null.

- Create a simple `BlueprintEvent` object.

**121.17.3.9 public BlueprintEvent(int type, Bundle bundle, Bundle extenderBundle, String[] dependencies)**

*type* The type of this event.

*bundle* The Blueprint bundle associated with this event. This parameter must not be null.

*extenderBundle* The Blueprint extender bundle that is generating this event. This parameter must not be null.

*dependencies* An array of `String` filters for each dependency associated with this event. Must be a non-empty array for event types `GRACE_PERIOD` and `WAITING`. It is optional for event type `FAILURE`. Must be null for other event types.

- Create a `BlueprintEvent` object associated with a set of dependencies.

**121.17.3.10 public BlueprintEvent(int type, Bundle bundle, Bundle extenderBundle, Throwable cause)**

*type* The type of this event.

*bundle* The Blueprint bundle associated with this event. This parameter must not be null.

*extenderBundle* The Blueprint extender bundle that is generating this event. This parameter must not be null.

*cause* A `Throwable` object describing the root cause of the event. May be null.

- Create a `BlueprintEvent` object associated with a failure cause.

**121.17.3.11 public BlueprintEvent(int type, Bundle bundle, Bundle extenderBundle, String[] dependencies, Throwable cause)**

*type* The type of this event.



*bundle* The Blueprint bundle associated with this event. This parameter must not be null.

*extenderBundle* The Blueprint extender bundle that is generating this event. This parameter must not be null.

*dependencies* An array of String filters for each dependency associated with this event. Must be a non-empty array for event types GRACE\_PERIOD and WAITING. It is optional for event type FAILURE. Must be null for other event types.

*cause* A Throwable object describing the root cause of this event. May be null.

- Create a BlueprintEvent object associated with a failure cause and a set of dependencies.

**121.17.3.12      public BlueprintEvent(BlueprintEvent event,boolean replay)**

*event* The original BlueprintEvent to copy. Must not be null.

*replay* true if this event should be used as a replay event.

- Create a new BlueprintEvent from the specified BlueprintEvent. The timestamp property will be copied from the original event and only the replay property will be overridden with the given value.

**121.17.3.13      public Bundle getBundle()**

- Return the Blueprint bundle associated with this event.

*Returns* The Blueprint bundle associated with this event.

**121.17.3.14      public Throwable getCause()**

- Return the cause for this FAILURE event.

*Returns* The cause of the failure for this event. May be null .

**121.17.3.15      public String[] getDependencies()**

- Return the filters identifying the missing dependencies that caused this event.

*Returns* The filters identifying the missing dependencies that caused this event if the event type is one of WAITING, GRACE\_PERIOD or FAILURE or null for the other event types.

**121.17.3.16      public Bundle getExtenderBundle()**

- Return the Blueprint extender bundle that is generating this event.

*Returns* The Blueprint extender bundle that is generating this event.

**121.17.3.17      public long getTimestamp()**

- Return the time at which this event was created.

*Returns* The time at which this event was created.

**121.17.3.18      public int getType()**

- Return the type of this event.

The type values are:

- CREATING
- CREATED
- DESTROYING
- DESTROYED
- FAILURE
- GRACE\_PERIOD
- WAITING

*Returns* The type of this event.

**121.17.3.19 public boolean isReplay()**

- Return whether this event is a replay event.

*Returns* true if this event is a replay event and false otherwise.

**121.17.4 public interface BlueprintListener**

A BlueprintEvent Listener.

To receive Blueprint Events, a bundle must register a Blueprint Listener service. After a Blueprint Listener is registered, the Blueprint extender must synchronously send to this Blueprint Listener the last Blueprint Event for each ready Blueprint bundle managed by this extender. This replay of Blueprint Events is designed so that the new Blueprint Listener can be informed of the state of each Blueprint bundle. Blueprint Events sent during this replay will have the `isReplay()` flag set. The Blueprint extender must ensure that this replay phase does not interfere with new Blueprint Events so that the chronological order of all Blueprint Events received by the Blueprint Listener is preserved. If the last Blueprint Event for a given Blueprint bundle is DESTROYED, the extender must not send it during this replay phase.

*See Also* BlueprintEvent

*Concurrency* Thread-safe

**121.17.4.1 public void blueprintEvent(BlueprintEvent event)**

*event* The BlueprintEvent.

- Receives notifications of a Blueprint Event. Implementers should quickly process the event and return.

**121.17.5 public class ComponentDefinitionException extends RuntimeException**

A Blueprint exception indicating that a component definition is in error. This exception is thrown when a configuration-related error occurs during creation of a Blueprint Container.

**121.17.5.1 public ComponentDefinitionException()**

- Creates a Component Definition Exception with no message or exception cause.

**121.17.5.2 public ComponentDefinitionException(String explanation)**

*explanation* The associated message.

- Creates a Component Definition Exception with the specified message

**121.17.5.3 public ComponentDefinitionException(String explanation,Throwable cause)**

*explanation* The associated message.

*cause* The cause of this exception.

- Creates a Component Definition Exception with the specified message and exception cause.

**121.17.5.4 public ComponentDefinitionException(Throwable cause)**

*cause* The cause of this exception.

- Creates a Component Definition Exception with the exception cause.

**121.17.6 public interface Converter**

Type converter to convert an object to a target type.

*Concurrency* Thread-safe

**121.17.6.1      public boolean canConvert(Object sourceObject, ReifiedType targetType)**

*sourceObject* The source object *s* to convert.

*targetType* The target type *T*.

- Return if this converter is able to convert the specified object to the specified type.

*Returns* true if the conversion is possible, false otherwise.

**121.17.6.2      public Object convert(Object sourceObject, ReifiedType targetType) throws Exception**

*sourceObject* The source object *s* to convert.

*targetType* The target type *T*.

- Convert the specified object to an instance of the specified type.

*Returns* An instance with a type that is assignable from *targetType*'s raw class

*Throws* Exception— If the conversion cannot succeed. This exception should not be thrown when the `canConvert` method has returned true.

**121.17.7      public class EventConstants**

Event property names used in Event Admin events published by a Blueprint Container.

Each type of event is sent to a different topic:

`org/osgi/service/blueprint/container/ <event-type>`

where `<event-type>` can have the values `CREATING`, `CREATED`, `DESTROYING`, `DESTROYED`, `FAILURE`, `GRACE_PERIOD`, or `WAITING`.

Such events have the following properties:

- type
- event
- timestamp
- bundle
- bundle.symbolicName
- bundle.id
- bundle.version
- extender.bundle.symbolicName
- extender.bundle.id
- extender.bundle.version
- dependencies
- cause

*Concurrency* Immutable

**121.17.7.1      public static final String BUNDLE = "bundle"**

The Blueprint bundle associated with this event. This property is of type `Bundle`.

**121.17.7.2      public static final String BUNDLE\_ID = "bundle.id"**

The bundle id of the Blueprint bundle associated with this event. This property is of type `Long`.

**121.17.7.3      public static final String BUNDLE\_SYMBOLICNAME = "bundle.symbolicName"**

The bundle symbolic name of the Blueprint bundle associated with this event. This property is of type `String`.

- 
- 121.17.7.4**      **public static final String BUNDLE\_VERSION = "bundle.version"**  
The bundle version of the Blueprint bundle associated with this event. This property is of type Version.
- 121.17.7.5**      **public static final String CAUSE = "cause"**  
The cause for a FAILURE event. This property is of type Throwable.
- 121.17.7.6**      **public static final String DEPENDENCIES = "dependencies"**  
The filters identifying the missing dependencies that caused this event for a FAILURE, GRACE\_PERIOD, or WAITING event. This property type is an array of String.
- 121.17.7.7**      **public static final String EVENT = "event"**  
The BlueprintEvent object that caused this event. This property is of type BlueprintEvent.
- 121.17.7.8**      **public static final String EXTENDER\_BUNDLE = "extender.bundle"**  
The Blueprint extender bundle that is generating this event. This property is of type Bundle.
- 121.17.7.9**      **public static final String EXTENDER\_BUNDLE\_ID = "extender.bundle.id"**  
The bundle id of the Blueprint extender bundle that is generating this event. This property is of type Long.
- 121.17.7.10**     **public static final String EXTENDER\_BUNDLE\_SYMBOLICNAME = "extender.bundle.symbolicName"**  
The bundle symbolic of the Blueprint extender bundle that is generating this event. This property is of type String.
- 121.17.7.11**     **public static final String EXTENDER\_BUNDLE\_VERSION = "extender.bundle.version"**  
The bundle version of the Blueprint extender bundle that is generating this event. This property is of type Version.
- 121.17.7.12**     **public static final String TIMESTAMP = "timestamp"**  
The time the event was created. This property is of type Long.
- 121.17.7.13**     **public static final String TOPIC\_BLUEPRINT\_EVENTS = "org/osgi/service/blueprint/container"**  
Topic prefix for all events issued by the Blueprint Container
- 121.17.7.14**     **public static final String TOPIC\_CREATED = "org/osgi/service/blueprint/container/CREATED"**  
Topic for Blueprint Container CREATED events
- 121.17.7.15**     **public static final String TOPIC\_CREATING = "org/osgi/service/blueprint/container/CREATING"**  
Topic for Blueprint Container CREATING events
- 121.17.7.16**     **public static final String TOPIC\_DESTROYED = "org/osgi/service/blueprint/container/DESTROYED"**  
Topic for Blueprint Container DESTROYED events
- 121.17.7.17**     **public static final String TOPIC\_DESTROYING = "org/osgi/service/blueprint/container/DESTROYING"**  
Topic for Blueprint Container DESTROYING events
- 121.17.7.18**     **public static final String TOPIC\_FAILURE = "org/osgi/service/blueprint/container/FAILURE"**  
Topic for Blueprint Container FAILURE events

**121.17.7.19**      **public static final String TOPIC\_GRACE\_PERIOD = "org/osgi/service/blueprint/container/GRACE\_PERIOD"**  
Topic for Blueprint Container GRACE\_PERIOD events

**121.17.7.20**      **public static final String TOPIC\_WAITING = "org/osgi/service/blueprint/container/WAITING"**  
Topic for Blueprint Container WAITING events

**121.17.7.21**      **public static final String TYPE = "type"**  
The type of the event that has been issued. This property is of type Integer and can take one of the values defined in BlueprintEvent.

## **121.17.8**      **public class NoSuchComponentException** **extends RuntimeException**

A Blueprint exception indicating that a component does not exist in a Blueprint Container. This exception is thrown when an attempt is made to create a component instance or lookup Component Metadata using a component id that does not exist in the Blueprint Container.

**121.17.8.1**      **public NoSuchComponentException(String msg,String id)**  
*msg* The associated message.  
*id* The id of the non-existent component.  
□ Create a No Such Component Exception for a non-existent component.

**121.17.8.2**      **public NoSuchComponentException(String id)**  
*id* The id of the non-existent component.  
□ Create a No Such Component Exception for a non-existent component.

**121.17.8.3**      **public String getComponentId()**  
□ Returns the id of the non-existent component.

*Returns* The id of the non-existent component.

## **121.17.9**      **public class ReifiedType**

Provides access to a concrete type and its optional generic type parameters.

Java 5 and later support generic types. These types consist of a raw class with type parameters. This class models such a Type class but ensures that the type is *reified*. Reification means that the Type graph associated with a Java 5 Type instance is traversed until the type becomes a concrete class. This class is available with the `getRawClass()` method. The optional type parameters are recursively represented as Reified Types.

In Java 1.4, a class has by definition no type parameters. This class implementation provides the Reified Type for Java 1.4 by making the raw class the Java 1.4 class and using a Reified Type based on the Object class for any requested type parameter.

A Blueprint extender implementations can subclass this class and provide access to the generic type parameter graph for conversion. Such a subclass must *reify* the different Java 5 Type instances into the reified form. That is, a form where the raw Class is available with its optional type parameters as Reified Types.

*Concurrency* Immutable

**121.17.9.1**      **public ReifiedType(Class<?> clazz)**  
*clazz* The raw class of the Reified Type.

- Create a Reified Type for a raw Java class without any generic type parameters. Subclasses can provide the optional generic type parameter information. Without subclassing, this instance has no type parameters.

#### 121.17.9.2 **public ReifiedType getActualTypeArgument(int i)**

*i* The zero-based index of the requested type parameter.

- Return a type parameter for this type. The type parameter refers to a parameter in a generic type declaration given by the zero-based index *i*. For example, in the following example:

```
Map<String, ? extends Metadata>
```

type parameter 0 is String, and type parameter 1 is Metadata.

This implementation returns a Reified Type that has Object as class. Any object is assignable to Object and therefore no conversion is then necessary. This is compatible with versions of Java language prior to Java 5. This method should be overridden by a subclass that provides access to the generic type parameter information for Java 5 and later.

*Returns* The ReifiedType for the generic type parameter at the specified index.

#### 121.17.9.3 **public Class<?> getRawClass()**

- Return the raw class represented by this type. The raw class represents the concrete class that is associated with a type declaration. This class could have been deduced from the generics type parameter graph of the declaration. For example, in the following example:

```
Map<String, ? extends Metadata>
```

The raw class is the Map class.

*Returns* The raw class represented by this type.

#### 121.17.9.4 **public int size()**

- Return the number of type parameters for this type.

This implementation returns 0. This method should be overridden by a subclass that provides access to the generic type parameter information for Java 5 and later.

*Returns* The number of type parameters for this type.

### 121.17.10 **public class ServiceUnavailableException extends ServiceException**

A Blueprint exception indicating that a service is unavailable. This exception is thrown when an invocation is made on a service reference and a backing service is not available.

#### 121.17.10.1 **public ServiceUnavailableException(String message,String filter)**

*message* The associated message.

*filter* The filter used for the service lookup.

- Creates a Service Unavailable Exception with the specified message.

#### 121.17.10.2 **public ServiceUnavailableException(String message,String filter,Throwable cause)**

*message* The associated message.

*filter* The filter used for the service lookup.

*cause* The cause of this exception.

- Creates a Service Unavailable Exception with the specified message and exception cause.

### 121.17.10.3 **public String getFilter()**

- Returns the filter expression that a service would have needed to satisfy in order for the invocation to proceed.

*Returns* The failing filter.

## 121.18 **org.osgi.service.blueprint.reflect**

Blueprint Reflection Package Version 1.0.

Bundles wishing to use this package must list the package in the Import-Package header of the bundle's manifest. This package has two types of users: the consumers that use the API in this package and the providers that implement the API in this package.

Example import for consumers using the API in this package:

```
Import-Package: org.osgi.service.blueprint.reflect; version="[1.0,2.0]"
```

Example import for providers implementing the API in this package:

```
Import-Package: org.osgi.service.blueprint.reflect; version="[1.0,1.1]"
```

### 121.18.1 **Summary**

- BeanArgument - Metadata for a factory method or constructor argument of a bean.
- BeanMetadata - Metadata for a Bean component.
- BeanProperty - Metadata for a property to be injected into a bean.
- CollectionMetadata - Metadata for a collection based value.
- ComponentMetadata - Metadata for managed components.
- IdRefMetadata - Metadata for the verified id of another component managed by the Blueprint Container.
- MapEntry - Metadata for a map entry.
- MapMetadata - Metadata for a Map based value.
- Metadata - Top level Metadata type.
- NonNullMetadata - Metadata for a value that cannot null.
- NullMetadata - Metadata for a value specified to be null via the <null> element.
- PropsMetadata - Metadata for a java.util.Properties based value.
- ReferenceListener - Metadata for a reference listener interested in the reference bind and unbind events for a service reference.
- ReferenceListMetadata - Metadata for a list of service references.
- ReferenceMetadata - Metadata for a reference that will bind to a single matching service in the service registry.
- RefMetadata - Metadata for a reference to another component managed by the Blueprint Container.
- RegistrationListener - Metadata for a registration listener interested in service registration and unregistration events for a service.
- ServiceMetadata - Metadata for a service to be registered by the Blueprint Container when enabled.
- ServiceReferenceMetadata - Metadata for a reference to an OSGi service.
- Target - A common interface for managed components that can be used as a direct target for method calls.

- ValueMetadata - Metadata for a simple String value that will be type-converted if necessary before injecting.

### 121.18.2 public interface BeanArgument

Metadata for a factory method or constructor argument of a bean. The arguments of a bean are obtained from BeanMetadata.getArguments(). This is specified by the argument elements of a bean.

*Concurrency* Thread-safe

#### 121.18.2.1 public int getIndex()

- Return the zero-based index into the parameter list of the factory method or constructor to be invoked for this argument. This is determined by specifying the index attribute for the bean. If not explicitly set, this will return -1 and the initial ordering is defined by its position in the BeanMetadata.getArguments() list. This is specified by the index attribute.

*Returns* The zero-based index of the parameter, or -1 if no index is specified.

#### 121.18.2.2 public Metadata getValue()

- Return the Metadata for the argument value. This is specified by the value attribute.

*Returns* The Metadata for the argument value.

#### 121.18.2.3 public String getValueType()

- Return the name of the value type to match the argument and convert the value into when invoking the constructor or factory method. This is specified by the type attribute.

*Returns* The name of the value type to convert the value into, or null if no type is specified.

### 121.18.3 public interface BeanMetadata extends Target, ComponentMetadata

Metadata for a Bean component.

This is specified by the bean element.

*Concurrency* Thread-safe

#### 121.18.3.1 public static final String SCOPE\_PROTOTYPE = "prototype"

The bean has prototype scope.

*See Also* getScope()

#### 121.18.3.2 public static final String SCOPE\_SINGLETON = "singleton"

The bean has singleton scope.

*See Also* getScope()

#### 121.18.3.3 public List<BeanArgument> getArguments()

- Return the arguments for the factory method or constructor of the bean. This is specified by the child argument elements.

*Returns* An immutable List of BeanArgument objects for the factory method or constructor of the bean. The List is empty if no arguments are specified for the bean.

#### 121.18.3.4 public String getClassName()

- Return the name of the class specified for the bean. This is specified by the class attribute of the bean definition.



*Returns* The name of the class specified for the bean. If no class is specified in the bean definition, because the a factory component is used instead, then this method will return null.

#### 121.18.3.5 **public String getDestroyMethod()**

- Return the name of the destroy method specified for the bean. This is specified by the `destroy-method` attribute of the bean definition.

*Returns* The name of the destroy method specified for the bean, or null if no destroy method is specified.

#### 121.18.3.6 **public Target getFactoryComponent()**

- Return the Metadata for the factory component on which to invoke the factory method for the bean. This is specified by the `factory-ref` attribute of the bean.

When a factory method and factory component have been specified for the bean, this method returns the factory component on which to invoke the factory method for the bean. When no factory component has been specified this method will return null. When a factory method has been specified for the bean but a factory component has not been specified, the factory method must be invoked as a static method on the bean's class.

*Returns* The Metadata for the factory component on which to invoke the factory method for the bean or null if no factory component is specified.

#### 121.18.3.7 **public String getFactoryMethod()**

- Return the name of the factory method for the bean. This is specified by the `factory-method` attribute of the bean.

*Returns* The name of the factory method of the bean or null if no factory method is specified for the bean.

#### 121.18.3.8 **public String getInitMethod()**

- Return the name of the init method specified for the bean. This is specified by the `init-method` attribute of the bean definition.

*Returns* The name of the init method specified for the bean, or null if no init method is specified.

#### 121.18.3.9 **public List<BeanProperty> getProperties()**

- Return the properties for the bean. This is specified by the child property elements.

*Returns* An immutable List of BeanProperty objects, with one entry for each property to be injected in the bean. The List is empty if no property injection is specified for the bean.

#### 121.18.3.10 **public String getScope()**

- Return the scope for the bean.

*Returns* The scope for the bean. Returns null if the scope has not been explicitly specified in the bean definition.

*See Also* SCOPE\_SINGLETON, SCOPE\_PROTOTYPE

### 121.18.4 **public interface BeanProperty**

Metadata for a property to be injected into a bean. The properties of a bean are obtained from `BeanMetadata.getProperties()`. This is specified by the property elements of a bean. Properties are defined according to the Java Beans conventions.

*Concurrency* Thread-safe

#### 121.18.4.1 **public String getName()**

- Return the name of the property to be injected. The name follows Java Beans conventions. This is specified by the `name` attribute.

*Returns* The name of the property to be injected.

#### 121.18.4.2 **public Metadata getValue()**

- Return the Metadata for the value to be injected into a bean. This is specified by the value attribute or in inlined text.

*Returns* The Metadata for the value to be injected into a bean.

### 121.18.5 **public interface CollectionMetadata extends NonNullMetadata**

Metadata for a collection based value. Values of the collection are defined by Metadata objects. This Collection Metadata can constrain the values of the collection to a specific type.

*Concurrency* Thread-safe

#### 121.18.5.1 **public Class<?> getCollectionClass()**

- Return the type of the collection. The possible types are: array (Object[]), Set, and List. This information is specified in the element name.

*Returns* The type of the collection. Object[] is returned to indicate an array.

#### 121.18.5.2 **public List<Metadata> getValues()**

- Return Metadata for the values of the collection.

*Returns* A List of Metadata for the values of the collection.

#### 121.18.5.3 **public String getValueType()**

- Return the type specified for the values of the collection. The value-type attribute specified this information.

*Returns* The type specified for the values of the collection.

### 121.18.6 **public interface ComponentMetadata extends NonNullMetadata**

Metadata for managed components. This is the base type for BeanMetadata, ServiceMetadata and ServiceReferenceMetadata.

*Concurrency* Thread-safe

#### 121.18.6.1 **public static final int ACTIVATION\_EAGER = 1**

The component's manager must eagerly activate the component.

*See Also* getActivation()

#### 121.18.6.2 **public static final int ACTIVATION\_LAZY = 2**

The component's manager must lazily activate the component.

*See Also* getActivation()

#### 121.18.6.3 **public int getActivation()**

- Return the activation strategy for the component. This is specified by the activation attribute of a component definition. If this is not set, then the default-activation in the blueprint element is used. If that is also not set, then the activation strategy is ACTIVATION\_EAGER.

*Returns* The activation strategy for the component.

*See Also* ACTIVATION\_EAGER, ACTIVATION\_LAZY

**121.18.6.4**      **public List<String> getDependsOn()**

- Return the ids of any components listed in a depends-on attribute for the component.

*Returns* An immutable List of component ids that are explicitly declared as a dependency, or an empty List if none.

**121.18.6.5**      **public String getId()**

- Return the id of the component.

*Returns* The id of the component. The component id can be null if this is an anonymously defined and/or in-lined component.

**121.18.7**      **public interface IdRefMetadata  
extends NonNullMetadata**

Metadata for the verified id of another component managed by the Blueprint Container. The id itself will be injected, not the component to which the id refers. No implicit dependency is created.

*Concurrency* Thread-safe

**121.18.7.1**      **public String getComponentId()**

- Return the id of the referenced component. This is specified by the component-id attribute of a component.

*Returns* The id of the referenced component.

**121.18.8**      **public interface MapEntry**

Metadata for a map entry. This type is used by MapMetadata, PropsMetadata and ServiceMetadata.

*Concurrency* Thread-safe

**121.18.8.1**      **public NonNullMetadata getKey()**

- Return the Metadata for the key of the map entry. This is specified by the key attribute or element.

*Returns* The Metadata for the key of the map entry. This must not be null.

**121.18.8.2**      **public Metadata getValue()**

- Return the Metadata for the value of the map entry. This is specified by the value attribute or element.

*Returns* The Metadata for the value of the map entry. This must not be null.

**121.18.9**      **public interface MapMetadata  
extends NonNullMetadata**

Metadata for a Map based value.

This is specified by the map element.

*Concurrency* Thread-safe

**121.18.9.1**      **public List<MapEntry> getEntries()**

- Return the entries for the map.

*Returns* An immutable List of MapEntry objects for each entry in the map. The List is empty if no entries are specified for the map.

**121.18.9.2**      **public String getKeyType()**

- Return the name of the type of the map keys. This is specified by the key-type attribute of the map.

*Returns* The name of the type of the map keys, or null if none is specified.

### 121.18.9.3 **public String getValueType()**

- Return the name of the type of the map values. This is specified by the value-type attribute of the map.

*Returns* The name of the type of the map values, or null if none is specified.

### 121.18.10 **public interface Metadata**

Top level Metadata type. All Metadata types extends this base type.

*Concurrency* Thread-safe

### 121.18.11 **public interface NonNullMetadata extends Metadata**

Metadata for a value that cannot null. All Metadata subtypes extend this type except for NullMetadata.

This Metadata type is used for keys in Maps because they cannot be null.

*Concurrency* Thread-safe

### 121.18.12 **public interface NullMetadata extends Metadata**

Metadata for a value specified to be null via the <null> element.

*Concurrency* Thread-safe

### 121.18.12.1 **public static final NullMetadata NULL**

Singleton instance of NullMetadata.

### 121.18.13 **public interface PropsMetadata extends NonNullMetadata**

Metadata for a java.util.Properties based value.

The MapEntry objects of properties are defined with keys and values of type String.

This is specified by the props element.

*Concurrency* Thread-safe

### 121.18.13.1 **public List<MapEntry> getEntries()**

- Return the entries for the properties.

*Returns* An immutable List of MapEntry objects for each entry in the properties. The List is empty if no entries are specified for the properties.

### 121.18.14 **public interface ReferenceListener**

Metadata for a reference listener interested in the reference bind and unbind events for a service reference.

*Concurrency* Thread-safe

### 121.18.14.1 **public String getBindMethod()**

- Return the name of the bind method. The bind method will be invoked when a matching service is bound to the reference. This is specified by the bind-method attribute of the reference listener.

*Returns* The name of the bind method.

#### **121.18.14.2 public Target getListenerComponent()**

- Return the Metadata for the component that will receive bind and unbind events. This is specified by the ref attribute or via an inlined component.

*Returns* The Metadata for the component that will receive bind and unbind events.

#### **121.18.14.3 public String getUnbindMethod()**

- Return the name of the unbind method. The unbind method will be invoked when a matching service is unbound from the reference. This is specified by the unbind-method attribute of the reference listener.

*Returns* The name of the unbind method.

### **121.18.15 public interface ReferenceListMetadata extends ServiceReferenceMetadata**

Metadata for a list of service references.

This is specified by the reference-list element.

*Concurrency* Thread-safe

#### **121.18.15.1 public static final int USE\_SERVICE\_OBJECT = 1**

Reference list values must be proxies to the actual service objects.

*See Also* getMemberType()

#### **121.18.15.2 public static final int USE\_SERVICE\_REFERENCE = 2**

Reference list values must be ServiceReference objects.

*See Also* getMemberType()

#### **121.18.15.3 public int getMemberType()**

- Return whether the List will contain service object proxies or ServiceReference objects. This is specified by the member-type attribute of the reference list.

*Returns* Whether the List will contain service object proxies or ServiceReference objects.

*See Also* USE\_SERVICE\_OBJECT, USE\_SERVICE\_REFERENCE

### **121.18.16 public interface ReferenceMetadata extends Target, ServiceReferenceMetadata**

Metadata for a reference that will bind to a single matching service in the service registry.

This is specified by the reference element.

*Concurrency* Thread-safe

#### **121.18.16.1 public long getTimeout()**

- Return the timeout for service invocations when a backing service is unavailable. This is specified by the timeout attribute of the reference.

*Returns* The timeout, in milliseconds, for service invocations when a backing service is unavailable.

### **121.18.17 public interface RefMetadata extends Target, NonNullMetadata**

Metadata for a reference to another component managed by the Blueprint Container.

*Concurrency* Thread-safe

### 121.18.17.1 **public String getComponentId()**

- Return the id of the referenced component. This is specified by the component-id attribute of a component.

*Returns* The id of the referenced component.

## 121.18.18 **public interface RegistrationListener**

Metadata for a registration listener interested in service registration and unregistration events for a service.

The registration listener is called with the initial state of the service when the registration listener is actuated.

*Concurrency* Thread-safe

### 121.18.18.1 **public Target getListenerComponent()**

- Return the Metadata for the component that will receive registration and unregistration events. This is specified by the ref attribute or via an inlined component.

*Returns* The Metadata for the component that will receive registration and unregistration events.

### 121.18.18.2 **public String getRegistrationMethod()**

- Return the name of the registration method. The registration method will be invoked when the associated service is registered with the service registry. This is specified by the registration-method attribute of the registration listener.

*Returns* The name of the registration method.

### 121.18.18.3 **public String getUnregistrationMethod()**

- Return the name of the unregistration method. The unregistration method will be invoked when the associated service is unregistered from the service registry. This is specified by the unregistration-method attribute of the registration listener.

*Returns* The name of the unregistration method.

## 121.18.19 **public interface ServiceMetadata extends ComponentMetadata**

Metadata for a service to be registered by the Blueprint Container when enabled.

This is specified by the service element.

*Concurrency* Thread-safe

### 121.18.19.1 **public static final int AUTO\_EXPORT\_ALL\_CLASSES = 4**

Advertise all Java classes and interfaces in the component instance type as service interfaces.

*See Also* getAutoExport()

### 121.18.19.2 **public static final int AUTO\_EXPORT\_CLASS\_HIERARCHY = 3**

Advertise all Java classes in the hierarchy of the component instance type as service interfaces.

*See Also* getAutoExport()

### 121.18.19.3 **public static final int AUTO\_EXPORT\_DISABLED = 1**

Do not auto-detect types for advertised service interfaces

*See Also* `getAutoExport()`

**121.18.19.4**      **public static final int AUTO\_EXPORT\_INTERFACES = 2**

Advertise all Java interfaces implemented by the component instance type as service interfaces.

*See Also* `getAutoExport()`

**121.18.19.5**      **public int getAutoExport()**

- Return the auto-export mode for the service. This is specified by the auto-export attribute of the service.

*Returns* The auto-export mode for the service.

*See Also* `AUTO_EXPORT_DISABLED`, `AUTO_EXPORT_INTERFACES`, `AUTO_EXPORT_CLASS_HIERARCHY`, `AUTO_EXPORT_ALL_CLASSES`

**121.18.19.6**      **public List<String> getInterfaces()**

- Return the type names of the interfaces that the service should be advertised as supporting. This is specified in the interface attribute or child interfaces element of the service.

*Returns* An immutable List of String for the type names of the interfaces that the service should be advertised as supporting. The List is empty if using auto-export or no interface names are specified for the service.

**121.18.19.7**      **public int getRanking()**

- Return the ranking value to use when advertising the service. If the ranking value is zero, the service must be registered without a `service.ranking` service property. This is specified by the ranking attribute of the service.

*Returns* The ranking value to use when advertising the service.

**121.18.19.8**      **public Collection<RegistrationListener> getRegistrationListeners()**

- Return the registration listeners to be notified when the service is registered and unregistered with the framework. This is specified by the registration-listener elements of the service.

*Returns* An immutable Collection of RegistrationListener objects to be notified when the service is registered and unregistered with the framework. The Collection is empty if no registration listeners are specified for the service.

**121.18.19.9**      **public Target getServiceComponent()**

- Return the Metadata for the component to be exported as a service. This is specified inline or via the ref attribute of the service.

*Returns* The Metadata for the component to be exported as a service.

**121.18.19.10**     **public List<MapEntry> getServiceProperties()**

- Return the user declared properties to be advertised with the service. This is specified by the service-properties element of the service.

*Returns* An immutable List of MapEntry objects for the user declared properties to be advertised with the service. The List is empty if no service properties are specified for the service.

**121.18.20**      **public interface ServiceReferenceMetadata**  
**extends ComponentMetadata**

Metadata for a reference to an OSGi service. This is the base type for ReferenceListMetadata and ReferenceMetadata.

*Concurrency* Thread-safe

**121.18.20.1 public static final int AVAILABILITY\_MANDATORY = 1**

A matching service is required at all times.

*See Also* `getAvailability()`

**121.18.20.2 public static final int AVAILABILITY\_OPTIONAL = 2**

A matching service is not required to be present.

*See Also* `getAvailability()`

**121.18.20.3 public int getAvailability()**

- Return whether or not a matching service is required at all times. This is specified in the availability attribute of the service reference.

*Returns* Whether or not a matching service is required at all times.

*See Also* `AVAILABILITY_MANDATORY`, `AVAILABILITY_OPTIONAL`

**121.18.20.4 public String getComponentName()**

- Return the value of the component-name attribute of the service reference. This specifies the id of a component that is registered in the service registry. This will create an automatic filter, appended with the filter if set, to select this component based on its automatic id attribute.

*Returns* The value of the component-name attribute of the service reference or null if the attribute is not specified.

**121.18.20.5 public String getFilter()**

- Return the filter expression that a matching service must match. This is specified by the filter attribute of the service reference.

*Returns* The filter expression that a matching service must match or null if a filter is not specified.

**121.18.20.6 public String getInterface()**

- Return the name of the interface type that a matching service must support. This is specified in the interface attribute of the service reference.

*Returns* The name of the interface type that a matching service must support or null when no interface name is specified.

**121.18.20.7 public Collection<ReferenceListener> getReferenceListeners()**

- Return the reference listeners to receive bind and unbind events. This is specified by the reference-listener elements of the service reference.

*Returns* An immutable Collection of ReferenceListener objects to receive bind and unbind events. The Collection is empty if no reference listeners are specified for the service reference.

**121.18.21 public interface Target  
extends NonNullMetadata**

A common interface for managed components that can be used as a direct target for method calls. These are bean, reference, and ref, where the ref must refer to a bean or reference component.

*See Also* `BeanMetadata`, `ReferenceMetadata`, `RefMetadata`

*Concurrency* Thread-safe

**121.18.22 public interface ValueMetadata  
extends NonNullMetadata**

Metadata for a simple String value that will be type-converted if necessary before injecting.



*Concurrency* Thread-safe

**121.18.22.1**      **public String getStringValue()**

- Return the unconverted string representation of the value. This is specified by the value attribute or text part of the value element.

*Returns* The unconverted string representation of the value.

**121.18.22.2**      **public String getType()**

- Return the name of the type to which the value should be converted. This is specified by the type attribute.

*Returns* The name of the type to which the value should be converted or null if no type is specified.

## 121.19      **References**

- [1] *Spring Framework*  
<http://www.springframework.org/>
- [2] *Spring Dynamic Modules*  
<http://www.springframework.org/osgi>
- [3] *Guice*  
<http://code.google.com/p/google-guice/>
- [4] *Picocontainer*  
<http://www.picocontainer.org/>
- [5] *Java Beans Specification*  
<http://www.oracle.com/technetwork/java/javase/tech/index-jsp-138795.html>
- [6] *XML Namespaces*  
<http://www.w3.org/TR/REC-xml-names>
- [7] *Properties format*  
<http://docs.oracle.com/javase/1.4.2/docs/api/java/util/Properties.html#load%28java.io.InputStream%29>
- [8] *XML Schema*  
<http://www.w3.org/XML/Schema>
- [9] *OSGi XML Schemas*  
<http://www.osgi.org/Specifications/HomePage>



# 122 Remote Service Admin Service Specification

## Version 1.1

### 122.1 Introduction

The *OSGi Core Release 6* framework specifies a model where bundles can use distributed services. The basic model for OSGi remote services is that a bundle can register services that are *exported* to a communication *Endpoint* and use services that are *imported* from a communication *Endpoint*. However, chapter *Remote Services* on page 21 does not explain *what* services are exported and/or imported; it leaves such decisions to the distribution provider. The distribution provider therefore performs multiple roles and cannot be leveraged by other bundles in scenarios that the distribution provider had not foreseen.

The primary role of the distribution provider is purely mechanical; it creates *Endpoints* and registers service proxies and enables their communication. The second role is about the policies around the desired topology. The third role is discovery. To establish a specific topology it is necessary to find out about exported services in other frameworks.

This specification therefore defines an API for the distribution provider and discovery of services in a network. A management agent can use this API to provide an actual distribution policy. This management agent, called the *Topology Manager*, can control the export and import of services delegating the intrinsic knowledge of the low level details of communication protocols, proxying of services, and discovering services in the network to services defined in this specification.

This specification is an extension of the *Remote Service* chapter. Though some aspects are repeated in this specification, a full understanding of the *Remote Services* chapter is required for full understanding of this document.

#### 122.1.1 Essentials

- *Simple* - Make it as simple as possible for a *Topology Manager* to implement distribution policies.
- *Dynamic* - Discover available *Endpoints* dynamically, for example through a discovery protocol like [3] *Service Location Protocol (SLP)* or [4] *JGroups*.
- *Inform* - Provide a mechanism to inform other parties about created and removed *Endpoints*.
- *Configuration* - Allow bundles to describe *Endpoints* as a bundle resource that are provided to the *Distribution Provider*.
- *Selective* - Not all parties are interested in all services. *Endpoint registries* must be able to express the scope of services they are interested in.
- *Multiple* - Allow the collaboration of multiple *Topology Managers*, *Remote Service Admin* services, and *Discovery Providers*.
- *Dynamic* - Allow the dynamic discovery of *Endpoints*.
- *Federated* - Enable a global view of all available services in a distributed environment.



- Service listeners to detect services that can be exported according to the Remote Services chapter.
- Listener and Find Hook services to detect bundles that have an interest in specific services that potentially could be imported.
- A Remote Service Admin Listener service to detect the activity of other Topology Managers.
- Endpoint Event Listener and Endpoint Listener services to detect Endpoints that are made available through discovery protocols, configuration data, or other means.

Using this information, the manager implements a topology using the Remote Service Admin service. A Topology Manager that wants to export a service can create an *Export Registration* by providing one or more Remote Service Admin services a Service Reference plus a Map with the required properties. A Remote Service Admin service then creates a number of Endpoints based on the available configuration types and returns a collection of ExportRegistration objects. A collection is returned because a single service can be exported to multiple Endpoints depending on the available configuration type properties.

Each Export Registration is specific for the caller and represents an existing or newly created Endpoint. The Export Registration associates the exported Service Reference with an *Endpoint Description*. If there are problems with the export operation, the Remote Service Admin service reports these on the Export Registration objects. That is, not all the returned Export Registrations have to be valid.

An Endpoint Description is a property based description of an Endpoint. Some of these properties are defined in this specification, other properties are defined by configuration types. These configuration types must follow the same rules as the configuration types defined in the Remote Services chapter. Remote Service Admin services that support the configuration types in the Endpoint Description can import a service from that Endpoint solely based on that Endpoint Description.

In similar vein, the Topology Manager can import a service from a remote system by creating an Import Registration out of an Endpoint Description. The Remote Service Admin service then registers a service that is a proxy for the remote Endpoint and returns an ImportRegistration object. If there are problems with the import, the Remote Service Admin service that cannot be detected early, then the Remote Service Admin service reports these on the returned ImportRegistration object.

For introspection, the Remote Service Admin can list its current set of Import and Export References so that a Topology Manager can get the current state. The Remote Service Admin service also informs all Topology Managers and observers of the creation, deletion, and errors of Import and Export Registrations through the Remote Service Admin Listener service. Interested parties like the Topology Manager can register such a service and will be called back with the initial state as well as any subsequent changes.

An important aspect of the Topology Manager is the distributed nature of the scenarios it plays an orchestrating role in. A Topology Manager needs to be aware of Endpoints in the network, not just the ones provided by Remote Service Admin services in its local framework. The Endpoint Event Listener service is specified for this purpose. This service is provided for both directions, symmetrically. That is, it is used by the Topology Manager to inform any observers about the existence of Endpoints that are locally available, as well as for parties that represent a discovery mechanism. For example Endpoints available on other systems, Endpoint Descriptions embedded in resources in bundles, or Endpoint Descriptions that are available in some other form.

Endpoint Event Listener services are not always interested in the complete set of available Endpoints because this set can potentially be very large. For example, if a remote registry like [5] *UDDI* is used then the number of Endpoints can run into the thousands or more. An Endpoint Event Listener service can therefore scope the set of Endpoints with an OSGi LDAP style filter. Parties that can provide information about Endpoints must only notify Endpoint Event Listener services when the Endpoint Description falls within the scope of the Endpoint Listener service. Parties that use some discovery mechanism can use the scope to trigger directed searches across the network.

**122.1.3.1****Endpoint Listener Services**

The 1.0 version of this specification defined an Endpoint Listener service, which has an identical purpose and similar behaviors to an Endpoint Event Listener service. Unfortunately the design of the Endpoint Listener limited its extensibility, meaning that it had to be replaced in version 1.1 of this specification.

In order to maintain backward compatible interoperability with Remote Service Admin 1.0 actors, Remote Service Admin 1.1 actors must continue to register Endpoint Listener services as well as Endpoint Event Listener services. They must also continue to call Endpoint Listener services as well as EndpointEventListener services.

**122.2 Actors**

The OSGi Remote Services specification is about the distribution of services. This specification does not outline the details of how the distribution provider knows the desired topology, this policy aspect is left up to implementations. In many situations, this is a desirable architecture because it provides freedom of implementation to the distribution provider. However, such an architecture does not enable a separation of the mechanisms and *policy*. Therefore, this Remote Service Admin specification provides an architecture that enables a separate bundle from the distribution provider to define the topology. It splits the responsibility of the Remote Service specification in a number of *roles*. These roles can all have different implementations but they can collaborate through the services defined in this specification. These roles are:

- *Topology Managers* - Topology Managers are the (anonymous) players that implement the policies for distributing services; they are closely aligned with the concept of an OSGi *management agent*. It is expected that Topology Managers will be developed for scenarios like import/export all applicable services, configuration based imports- and exports, and scenarios like fail-over, load-balancing, as well as standards like domain managers for the [6] *Service Component Architecture (SCA)*.
- *Remote Service Admin* - The Remote Service Admin service provides the basic mechanism to import and export services. This service is policy free; it will not distribute services without explicitly being told so. A OSGi framework can host multiple Remote Service Admin services that, for example, support different configuration types.
- *Discovery* - To implement a distribution policy, a Topology Manager must be aware of what Endpoints are available. This specification provides an abstraction of a *federated Endpoint registry*. This registry can be used to both publish as well as consume Endpoints from many different sources. The federated registry is defined for local services but is intended to be used with standard and proprietary service discovery protocols. The federated registry is implemented with the Endpoint Event Listener service.

These roles are depicted in Figure 122.2 on page 746.

Figure 122.2

Roles

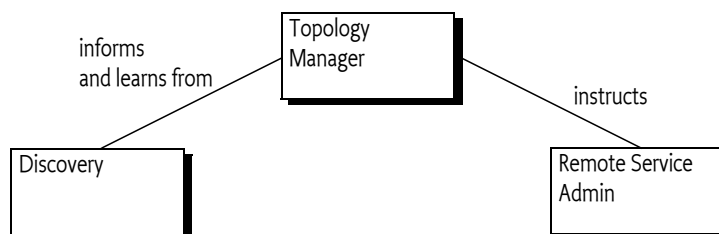

## 122.3 Topology Managers

Distributed processing has become mainstream because of the massive scale required for Internet applications. Only with distributed architectures is it possible to scale systems to *Internet size* with hundreds of millions of users. To allow a system to scale, servers are grouped in clusters where they can work in unison or geographically dispersed in even larger configurations. The distribution of the work-load is crucial for the amount of scalability provided by an architecture and often has domain specific dispatching techniques. For example, the hash of a user id can be used to select the correct profile database server. In this fast moving world it is very unlikely that a single architecture or distribution policy would be sufficient to satisfy many users. It is therefore that this specification separates the *how* from the *what*. The complex mechanics of importing and exporting services are managed by a Remote Service Admin service (the how) while the different policies are implemented by Topology Managers (the what). This separation of concerns enables the development of Topology Managers that can run on many different systems, providing high user functionality. For example, a Topology Manager could implement a fail-over policy where some strategic services are redirected when their connections fail. Other Topology Managers could use a discovery protocol like SLP to find out about other systems in a cluster and automatically configure the cluster.

The key value of this architecture is demonstrated by the example of an *SCA domain controller*. An SCA domain controller receives a description of a domain (a set of systems and modules) and must ensure that the proper connections are made between the participating SCA modules. By splitting the roles, an SCA domain manager can be developed that can run on any compatible Remote Service Admin service implementation.

### 122.3.1 Multiple Topology Managers

There is no restriction on the number of Topology Managers, nor is there a restriction on the number of Remote Service Admin service implementations. It is up to the deployer of the OSGi framework to select the appropriate set of these service implementations. It is the responsibility of the Topology Managers to listen to the Remote Service Admin Listener and track Endpoints created and deleted by other Topology Managers and act appropriately.

### 122.3.2 Example Use Cases

#### 122.3.2.1 Promiscuous Policy

A *cluster* is a set of machines that are connected in a network. The simplest policy for a Topology Manager is to share exported services in such a cluster. Such a policy is very easy to implement with the Remote Services Admin service. In the most basic form, this Topology Manager would use some multicast protocol to communicate with its peers. These peers would exchange EndpointDescription objects of exported services. Each Topology Manager would then import any exported service.

This scenario can be improved by separating the promiscuous policy from the discovery. Instead of embedding the multicast protocol, a Topology manager could use the Endpoint Event Listener service. This service allows the discovery of remote services. At the same time, the Topology Manager could tell all other Endpoint Event Listener services about the services it has created, allowing them to be used by others in the network.

Splitting the Topology Manager and discovery in two bundles allows different implementations of the discovery bundle, for example, to use different protocols. See [PROMISCUOUS\\_POLICY](#).

#### 122.3.2.2 Fail Over

A more elaborate scheme is a *fail-over policy*. In such a policy a service can be replaced by a service from another machine. There are many ways to implement such a policy, an simple example strategy is provided here for illustration.

A Fail-Over Topology Manager is given a list of stateless services that require fail-over, for example through the *Configuration Admin Service Specification* on page 87. The Fail-Over Manager tracks the systems in the its cluster that provide such services. This tracking can use an embedded protocol or it can be based on the Endpoint Event Listener service model.

In the Fail-Over policy, the fail-over manager only imports a single service and then tracks the error status of the imported service through the Remote Service Admin Listener service. If it detects the service is becoming unavailable, it closes the corresponding Import Registration and imports a service from an alternative system instead. In Figure 122.3, there are 4 systems in a cluster. The topology/fail-over manager ensures that there is always one of the services in system A, B, or C available in D.

Figure 122.3

Fail Over Scenario in a cluster

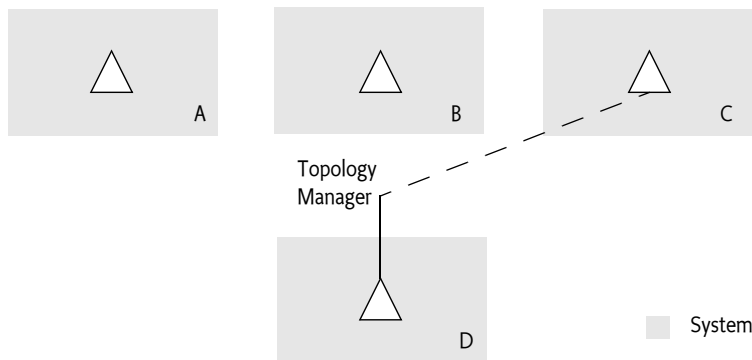

There are many possible variations on this scenario. The managers could exchange load information, allowing the service switch to be influenced by the load of the target systems. The important aspect is that the Topology Manager can ignore the complex details of discovery protocols, communication protocols, and service proxying and instead focus on the topology. See [FAIL\\_OVER\\_POLICY](#).

## 122.4 Endpoint Description

An *Endpoint* is a point of rendezvous of distribution providers. It is created by an exporting distribution provider or some other party, and is used by importing distribution providers to create a connection. An *Endpoint Description* describes an Endpoint in such a way that an importing Remote Service Admin service can create this connection if it recognizes the *configuration type* that is used for that Endpoint. The configuration type consists of a name and a set of properties associated with that name.

The core concept of the Endpoint Description is a Map of properties. The structure of this map is the same as service properties, and the defined properties are closely aligned with the properties of an imported service. An EndpointDescription object must only consist of the data types that are supported for service properties. This makes the property map serializable with many different mechanisms. The EndpointDescription class provides a convenient way to access the properties in a type safe way.

An Endpoint Description has case insensitive keys, just like the Service Reference's properties.

The properties map must contain all the prescribed service properties of the exported service after intents have been processed, as if the service was registered as an imported service. That is, the map must not contain any properties that start with `service.exported.*` but it must contain the `service.imported.*` variation of these properties. The Endpoint Description must reflect the imported service properties because this simplifies the use of filters from the service hooks. Filters applied to the Endpoint Description can then be the same filters as applied by a bundle to select an imported service from the service registry.



The properties that can be used in an Endpoint Description are listed in Table 122.1. The RemoteConstants class contains the constants for all of these property names.

Table 122.1 *Endpoint Properties*

Endpoint Property Name	Type	Description
service.exported.*		Must not be set
service.imported	*	Must always be set to some value. See <a href="#">SERVICE_IMPORTED</a> .
objectClass	String[]	Must be set to the value of <code>service.exported.interfaces</code> , of the exported service after expanding any wildcards. Though this property will be overridden by the framework for the corresponding service registration, it must be set in the Endpoint Description to simplify the filter matching. These interface names are available with the <a href="#">getInterfaces()</a> method.
service.intents	String+	Intents implemented by the exporting distribution provider and, if applicable, the exported service itself. Any qualified intents must have their expanded form present. These expanded intents are available with the <a href="#">getIntentents()</a> method. See <a href="#">SERVICE_INTENTS</a> .
endpoint.service.id	Long	The service id of the exported service. Can be absent or 0 if the corresponding Endpoint is not for an OSGi service. The remote service id is available as <a href="#">getServiceId()</a> . See also <a href="#">ENDPOINT_SERVICE_ID</a> .
endpoint.framework.uuid	String	A universally unique id identifying the instance of the exporting framework. Can be absent if the corresponding Endpoint is not for an OSGi service. See <i>Framework UUID</i> on page 751. The remote framework UUID is available with the <a href="#">getFrameworkUUID()</a> method. See also <a href="#">ENDPOINT_FRAMEWORK_UUID</a> .
endpoint.id	String	The Id for this Endpoint, can never be null. This information is available with the <a href="#">getId()</a> . See <i>Endpoint Id</i> on page 751 and also <a href="#">ENDPOINT_ID</a> .
endpoint.package.version.<package-name>	String	The Java package version for the embedded <package>. For example, the property <code>endpoint.package.version.com.acme=1.3</code> describes the version for the <code>com.acme</code> package. The version for a package can be obtained with the <a href="#">getPackageVersion(String)</a> .  The version does not have to be set, if not set, the value must be assumed to be 0.
service.imported.configs	String+	The configuration types that can be used to implement the corresponding Endpoint. This property maps to the corresponding property in the Remote Services chapter. This property can be obtained with the <a href="#">getConfigurationTypes()</a> method.  The Export Registration has all the possible configuration types, where the Import Registration reports the configuration type actually used. See <a href="#">SERVICE_IMPORTED_CONFIGS</a> .

Endpoint Property Name	Type	Description
<config>.*	*	Where <config> is one of the configuration type names listed in <code>service.imported.configs</code> . The content of these properties must be valid for creating a connection to the Endpoint in another framework. That is, any locally readable URLs from bundles must be converted in such a form that they can be read by the importing framework. How this is done is configuration type specific.
*	*	All remaining public service properties must be present (that is, not starting with full stop (' \u002E)). If the values can not be marshaled by the Distribution Provider then they must be ignored.

The `EndpointDescription` class has a number of constructors that make it convenient to instantiate it for different purposes:

- [EndpointDescription\(Map\)](#) - Instantiate the Endpoint Description from a Map object.
- [EndpointDescription\(ServiceReference,Map\)](#) - Instantiate an Endpoint Description based on a Service Reference and a Map. The base properties of this Endpoint Description are the Service Reference properties but the properties in the given Map must override any of their case variants in the Service Reference. This allows the construction of an Endpoint Description from an exportable service while still allowing overrides of specific properties by the Topology Manager.

The Endpoint Description must use the allowed properties as given in Table 122.1 on page 749. The Endpoint Description must automatically skip any `service.exported.*` properties.

The Endpoint Description provides the following methods to access the properties in a more convenient way:

- [getInterfaces\(\)](#) - Answers a list of Java interface names. These are the interfaces under which the services must be registered. These interface names can also be found at the `objectClass` property. A service can only be imported when there is at least one Java interface name available.
- [getConfigurationTypes\(\)](#) - Answer the configuration types that are used for exporting this Endpoint. The configuration types are associated with a number of properties.
- [getId\(\)](#) - Returns an Id uniquely identifying an Endpoint. The syntax of this Id should be defined in the specification for the associated configuration type. Two Endpoint Descriptions with the same Id describe the same Endpoint.
- [getFrameworkUUID\(\)](#) - Get a Universally Unique Identifier (UUID) for the framework instance that has created the Endpoint, *Framework UUID* on page 751.
- [getServiceId\(\)](#) - Get the service id for the framework instance that has created the Endpoint. If there is no service on the remote side the value must be 0.
- [getPackageVersion\(String\)](#) - Get the version for the given package.
- [getIntents\(\)](#) - Get the list of specified intents.
- [getProperties\(\)](#) - Get all the properties.

Two Endpoint Descriptions are deemed equal when their Endpoint Id is equal. The Endpoint Id is a mandatory property of an Endpoint Description, it is further described at *Endpoint Id* on page 751. The hash code is therefore also based on the Endpoint Id.

### 122.4.1

#### Validity

A valid Endpoint Description must at least satisfy the following assertions:

- It must have a non-null Id that uniquely identifies the Endpoint

- It must at least have one Java interface name
- It must at least have one configuration type set
- Any version for the packages must have a valid version syntax.

### 122.4.2 Mutability

An EndpointDescription object is immutable and with all final fields. It can be freely used between different threads.

### 122.4.3 Endpoint Id

An Endpoint Id is an opaque unique identifier for an Endpoint. This uniqueness must at least hold for the entire network in which the Endpoint is used. There is no syntax defined for this string except that white space at the beginning and ending must be ignored. The actual syntax for this Endpoint Id must be defined by the actual configuration type.

Two Endpoint Descriptions are deemed identical when their Endpoint Id is equal. The Endpoint Ids must be compared as string compares with leading and trailing spaces removed. The Endpoint Description class must use the String class' hash Code from the Endpoint Id as its own hashCode.

The simplest way to ensure that a growth in the number of EndpointDescriptions and/or the size of the connected group does not violate the required uniqueness of Endpoint Ids is for implementations to make their Endpoint Ids globally unique. This protects against clashes regardless of changes to the connected group.

Whilst globally unique identifiers (GUIDs) are a simple solution to the Endpoint Id uniqueness problem, they are not easy to implement in all environments. In some systems they can be prohibitively expensive to create, or of insufficient entropy to be genuinely unique. Some distribution providers may therefore choose not to use random GUIDs.

In the case where no globally unique value is used the following actions are recommended (although not required).

- Distribution Providers protect against intra-framework clashes using some known value unique to the service, for example the service id.
- Distribution Providers protect against inter-provider collisions within a single framework by using some unique value, such as the distribution provider's bundle id. The distribution provider bundle's symbolic name is insufficient, as there may be multiple versions of the same distribution provider installed within a single framework.
- Distribution Providers protect against inter-framework collisions using some value unique to the framework, such as the framework UUID.

### 122.4.4 Framework UUID

Each framework registers its services with a service id that is only unique for that specific framework. The OSGi framework is not a singleton, making it possible that a single VM process holds multiple OSGi frameworks. Therefore, to identify an OSGi service uniquely it is necessary to identify the framework that has registered it. This identifier is a *Universally Unique Identifier* (UUID) that is set for each framework. This UUID is contained in the following framework property:

```
org.osgi.framework.uuid
```

If an Endpoint Description has no associated OSGi service then the UUID of that Endpoint Description must not be set and its service id must be 0.

A local Endpoint Description will have its framework UUID set to the local framework. This makes it straightforward to filter for Endpoint Descriptions that are describing local Endpoints or that describe remote Endpoints. For example, a manager can take the filter from a listener and ensure that it is only getting remote Endpoint Descriptions:

```
(&
  (!
    (service.remote.framework.uuid
      =72dc5fd9-5f8f-4f8f-9821-9ebb433a5b72)
    )
  (objectClass=org.osgi.service.log.LogService)
)
```

Where 72dc5fd9-5f8f-4f8f-9821-9ebb433a5b72 is the UUID of the local framework. A discovery bundle can register the following filter in its scope to receive all locally generated Endpoints:

```
(service.remote.framework.uuid
  =72dc5fd9-5f8f-4f8f-9821-9ebb433a5b72)
```

### 122.4.5 Resource Containment

Configuration types can use URLs to point to local resources describing in detail the Endpoint parameters for specific protocols. However, the purpose of an Endpoint Description is to describe an Endpoint to a remote system. This implies that there is some marshaling process that will transfer the Endpoint Description to another process. This other process is unlikely to be able to access resource URLs. Local bundle resource URLs are only usable in the framework that originates them but even HTTP based URLs can easily run into problems due to firewalls or lack of routing.

Therefore, the properties for a configuration type should be stored in such a way that the receiving process can access them. One way to achieve this is to contain the configuration properties completely in the Endpoint Description and ensure they only use the basic data types that the remote services chapter in the core requires every Distribution Provider to support.

The Endpoint Description XML format provides an `xml` element that is specifically added to make it easy to embed XML based configuration documents. The XML Schema is defined in *Endpoint Description Extender Format* on page 763.

## 122.5 Remote Service Admin

The Remote Service Admin service abstracts the core functionality of a distribution provider: exporting a service to an Endpoint and importing services from an Endpoint. However, in contrast with the distribution provider of the Remote Services specification, the Remote Service Admin service must be told explicitly what services to import and export.

### 122.5.1 Exporting

An exportable service can be exported with the `exportService(ServiceReference, Map)` method. This method creates a number of Endpoints by inspecting the merged properties from the Service Reference and the given Map. Any property in the Map overrides the Service Reference properties, regardless of case. That is, if the map contains a key then it will override any case variant of this key in the Service Reference. However, if the Map contains the `objectClass` or `service.id` property key in any case variant, then these properties must not override the Service Reference's value.

The Remote Service Admin service must interpret the merged properties according to the Remote Services chapter. This means that it must look at the following properties (as defined in chapter *Remote Services* on page 21):

- `service.exported.configs` - (String+ ) A list of configuration types that should be used to export this service. Each configuration type represents the configuration parameters for an Endpoint. A Remote Service Admin service should create an Endpoint for each configuration type that it supports and ignore the types it does not recognize. If this property is not set, then the Remote Service Admin implementation must choose a convenient configuration type that then must be

reported on the Endpoint Description with the `service.imported.configs` associated with the returned Export Registration.

- `service.exported.intents` - (String+) A list of intents that the Remote Service Admin service must implement to distribute the given service.
- `service.exported.intents.extra` - (String+) This property is merged with the `service.exported.intents` property.
- `service.exported.interfaces` - (String+) This property must be set; it marks this service for export and defines the interfaces. The list members must all be contained in the types listed in the `objectClass` service property from the Service Reference. The single value of an asterisk ('\*\u002A') indicates all interfaces in the registration's `objectClass` property and ignore the classes. Being able to set this property outside the Service Reference implies that the Topology Manager can export any registered service, also services not specifically marked to be exported.
- `service.intents` - (String+) A list of intents that this service has implemented.

A Topology Manager cannot remove properties, null is invalid as a property value.

The Remote Service Admin returns a collection of `ExportRegistration` objects. This collection must contain an entry for each configuration type the Remote Service Admin has recognized. Unrecognized configuration types must be ignored. However, it is possible that this list contains *invalid registrations*, see *Invalid Registrations* on page 756.

If a Service was already exported then the Remote Service Admin must still return a new `ExportRegistration` object that is linked with the earlier registrations. That is, an Endpoint can be shared between multiple Export Registrations. The Remote Service Admin service must ensure that the corresponding Endpoint remains available as long as there is at least one open Export Registration for that Endpoint.

For each successful creation of an export registration, the Remote Service Admin service must publish an `EXPORT_REGISTRATION` event, see *Events* on page 761. This event must be emitted, even if the Endpoint already existed and is thus shared with another Export Registration. If the creation of an Endpoint runs into an error, an `EXPORT_ERROR` event must be emitted.

Each valid Export Registration corresponds to an Endpoint for the given service. This Endpoint must remain active until all of the Export Registrations are closed that share this Endpoint.

The Endpoint can now be published so that other processes or systems can import this Endpoint. To aid with this import, the Export Registration has a `getExportReference()` method that returns an `ExportReference` object. This reference provides the following information:

- `getExportedEndpoint()` - This is the associated Endpoint Description. This Endpoint Description is a properties based description of an Endpoint. The property keys and their semantics are outlined in *Endpoint Description* on page 748. It can be used to inform other systems of the availability of an Endpoint.
- `getExportedService()` - The Service Reference to the exported service.

Both methods must return null when the associated Export Registration is closed.

A Distribution Provider that recognizes the configuration type in an Endpoint can create a connection to an Endpoint on other systems as long as firewalls and networks permit. The Endpoint Description can therefore be communicated to other systems to announce the availability of an Endpoint. The Topology Manager can optionally announce the availability of an Endpoint to the Endpoint Event Listener services, see *Discovery* on page 757. The decision to announce the availability of an Endpoint is one of the policies that is provided by a specific Topology Manager.

The Export Registrations remain open until:

- Explicitly closed by the Topology Manager, or
- The Remote Service Admin service is no longer used by the Topology Manager that created the Export Registration.

If the Remote Service Admin service can no longer maintain the corresponding Endpoint due to failures than these should be reported through the events. However, the registrations should remain open until explicitly closed by the Topology Manager.

See *Registration Life Cycle* on page 756 for more information.

The Export Registrations are not permanent; persistence is in the realm of the Topology Manager.

## 122.5.2 Importing

To import a service, a Topology Manager must have an Endpoint Description that describes the Endpoint the imported service should connect to. With this Endpoint Description, a Remote Service Admin service can then import the corresponding Endpoint. A Topology Manager can obtain these Endpoint Descriptions through internal configuration; it can use the discovery model enabled by the Endpoint Event Listener service, see *Discovery* on page 757, or some alternate means.

A service can be imported with the Remote Service Admin `importService(EndpointDescription)` method. This method takes an Endpoint Description and picks one of the embedded configuration types to establish a connection with the corresponding Endpoint to create a local service proxy. This proxy can then be mapped to either a remote OSGi service or an alternative, for example a web service. In certain cases the service proxy can be lazy, only verifying the reachability of the Endpoint when it is actually invoked for the first time. This implies that a service proxy can block when invoked until the proper communication setup has taken place.

If the Remote Service Admin service does not recognize any of the configuration types then it must return null. If there are multiple configuration types recognized then the Remote Service Admin is free to select any one of the recognized types.

The Remote Service Admin service must ensure that service properties are according to the Remote Services chapter for an imported service. This means that it must register the following properties:

- `service.imported` - (\*) Must be set to any value.
- `service.imported.configs` - (String+) The configuration information used to import this service. Any associated properties for this configuration types must be properly mapped to the importing system. For example, a URL in these properties must point to a valid resource when used in the importing framework, see *Resource Containment* on page 752. Multiple configuration types can be listed if they are synonyms for exactly the same Endpoint that is used to export this service.
- `service.intents` - (String+) The Remote Service Admin must set this property to convey the combined intents of:
  - The exporting service, and
  - The intents that the exporting distribution provider adds, and
  - The intents that the importing distribution provider adds.
- Any additional properties listed in the Endpoint Description that should not be excluded. See *Endpoint Description* on page 748 for more details about the properties in the Endpoint Description.

A Remote Service Admin service must strictly follow the rules for importing a service as outlined in the Remote Services chapter.

The Remote Service Admin must return an `ImportRegistration` object or null. Even if an `ImportRegistration` is returned, it can still be an *invalid registration*, see *Invalid Registrations* on page 756 if the setup of the connection failed asynchronously. The `ImportRegistration` must always be a new object. Each valid `ImportRegistration` corresponds to a proxy service, potentially shared, that was created for the given Endpoint. The issues around proxying are described in *Proxying* on page 756.

For each successful creation of an import registration, the Remote Service Admin service must publish an `IMPORT_REGISTRATION` event, if there is an error it must publish an `IMPORT_ERROR`, see *Events* on page 761.

For more information see *Registration Life Cycle* on page 756.

The Import Registration provides access to an [ImportReference](#) object with the [getImportReference\(\)](#). This object has the following methods:

- [getImportedEndpoint\(\)](#) - Provides the Endpoint Description for this imported service.
- [getImportedService\(\)](#) - Provides the Service Reference for the service proxy.

The Import Registration will remain open as long as:

- The corresponding remote Endpoint remains available, and
- The Remote Service Admin service is still in use by the Topology Manager that created the Import Registration.

That is, the Import Registrations are not permanent, any persistence is in the realm of the Topology Manager. See *Registration Life Cycle* on page 756 for more details.

### 122.5.3 Updates

Services Registrations are dynamic and service properties may change during the lifetime of a service. Remote services must mirror these dynamics without making it appear as though the service has become unavailable. This requires that the exporting distribution provider and the importing distribution provider support the changing of service properties.

There are two types of service properties:

- Properties that are intended to be consumed by the distribution provider, such as: the exported interfaces and configuration types, exported intents and configuration type specific properties. These properties are typically prefixed with 'service.' or 'endpoint.' see Table 122.1 on page 749.
- Service properties not intended for the distribution provider. These are typically used to communicate information to the consumer of the service and are often specific to the domain of the service.

The following methods to support the updating of service properties on Export Registrations and the propagation of these updates to the remote proxies via Import Registrations.

- [ExportRegistration.update\(Map\)](#) - Allows the Topology Manager to update an existing export registration it created after receiving a notification of changed properties on the remoted service.
- [ImportRegistration.update\(EndpointDescription\)](#) - Allows the Topology Manager to update the import registration representing a remote service after the remote service properties have been updated. Typically the topology manager is notified of such change via the Discovery mechanism.

The distribution provider must support the updates of service properties *not* intended for the distribution provider, where supported property values are as defined in the *Filter Syntax* of *OSGi Core Release 6*. Distribution providers may support updates to a wider set of properties or data types, but these may fail with other implementations.

### 122.5.4 Reflection

The Remote Service Admin service provides the following methods to get the list of the current exported and imported services:

- [getExportedServices\(\)](#) - List the Export References for services that are exported by this Remote Service Admin service as directed by any of the Topology Managers.
- [getImportedEndpoints\(\)](#) - List the Import References for services that have been imported by this Remote Service Admin service as directed by any of the Topology Managers.

### 122.5.5 Registration Life Cycle

All registrations obtained through a Remote Service Admin service are life cycle bound to the Topology Manager that created it. That is, if a Topology Manager ungets its Remote Service Admin service, all registrations obtained through this service must automatically be closed. This model ensures that all registrations are properly closed if either the Remote Service Admin or the Topology Manager stops because in both cases the framework performs the unget automatically. Such behavior can be achieved by implementing the Remote Service Admin service as a Service Factory.

### 122.5.6 Invalid Registrations

The Remote Service Admin service is explicitly allowed to return *invalid* Import and Export Registrations. First, in a communications stack it can take time to discover that there are issues, allowing the registration to return before it has completed can potentially save time. Second, it allows the Topology Manager to discover problems with the configuration information. Without the invalid Export Registrations, the Topology Manager would have to scan the log or associate the Remote Service Admin Events with a specific import/export method call, something that can be difficult to do.

If the registration is invalid, the `getException()` method must return a Throwable object. If the registration has initialized correctly, this method will return null. The `getExportReference()` and `getImportReference()` methods must throw an Illegal State Exception when the registration is invalid. A Remote Service Admin service is allowed to block for a reasonable amount of time when any of these methods is called, including the `getException` method, to finish initialization.

An invalid registration can be considered as never having been opened, it is therefore not necessary to close it; however, closing an invalid or closed registration must be a dummy operation and never throw an Exception. However, a failed registration must generate a corresponding error event.

### 122.5.7 Proxying

It is the responsibility of the Remote Service Admin service to properly proxy an imported service. This specification does not mandate the technique used to proxy an Endpoint as a service in the OSGi framework. The OSGi Remote Services specification allows a distribution provider to limit what it can proxy.

One of the primary aspects of a proxy is to ensure class space consistency between the exporting bundle and importing bundles. This can require the generation of a proxy-per-bundle to match the proper class spaces. It is the responsibility of the Remote Service Admin to ensure that no Class Cast Exceptions occur.

A common technique to achieve maximum class space compatibility is to use a Service Factory. A Service Factory provides the calling bundle when it first gets the service, making it straightforward to verify the package version of the interface that the calling bundle uses. Knowing the bundle that requests the service allows the creation of specialized proxies for each bundle. The interface class(es) for the proxy can then be loaded directly from the bundle, ensuring class compatibility. Interfaces should be loadable by the bundle otherwise that bundle can not use the interface in its code. If an interface cannot be loaded then it can be skipped. A dedicated class loader can then be created that has visibility to all these interfaces and is used to define the proxy class. This design ensures proper visibility and consistency. Implementations can optimize this model by sharing compatible class loaders between bundles.

The proxy will have to call arbitrary methods on arbitrary services. This has a large number of security implications, see *Security* on page 771.



## 122.6 Discovery

The topology of the distributed system is decided by the Topology Manager. However, in a distributed environment, the Topology Manager needs to *discover* Endpoints in other frameworks. There is a very large number of ways how a Topology Manager could learn about other Endpoints, ranging from static configuration, a centralized administration, all the way to fully dynamic discovery protocols like the Service Location Protocol (SLP) or JGroups. To support the required flexibility, this specification defines an *Endpoint Event Listener* service that allows the dissemination of Endpoint information. This service provides a symmetric solution because the problem is symmetric: it is used by a Topology Manager to announce changes in its local topology as well as find out about other Endpoint Descriptions. Where those other Endpoint Descriptions come from can vary widely. This design is depicted in Figure 122.4 on page 757.

Figure 122.4 Examples

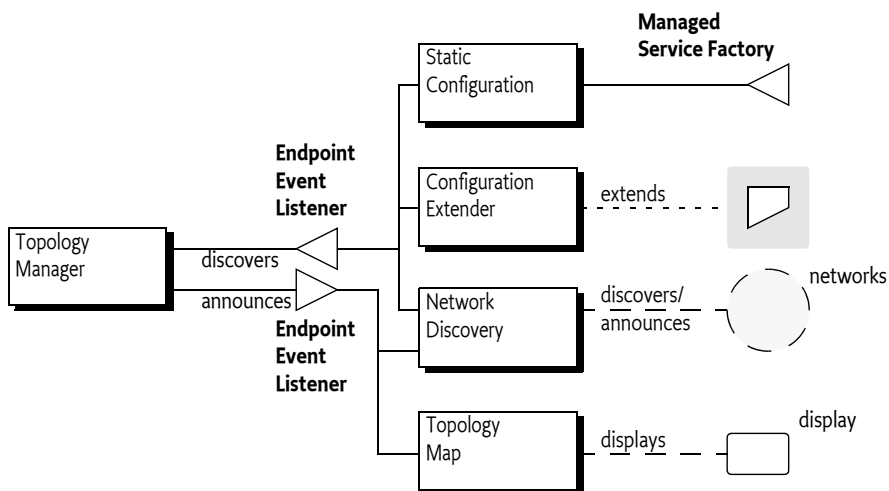

The design of the Endpoint Event Listener allows a federated registry of Endpoint Descriptions. Any party that is interested in Endpoint Descriptions should register an Endpoint Event Listener service. This will signal that it is interested in topology information to any *Endpoint Description Providers*. Each Endpoint Event Listener service must be registered with a service property that holds a set of filter strings to indicate the *scope* of its interest. These filters must match an Endpoint Description before the corresponding Endpoint Event Listener service is notified of the availability of an Endpoint Description. Scoping is intended to limit the delivery of unnecessary Endpoint Descriptions as well as signal the need for specific Endpoints.

In addition to providing an Endpoint Event Listener actors must provide an Endpoint Listener. This may, or may not, be the same service object as the Endpoint Event Listener. Registering an Endpoint Listener in addition to an Endpoint Event Listener ensures that Endpoint announcements from version 1.0 actors will continue to be visible. If a service object is advertised as both an Endpoint Listener *and* an Endpoint Event Listener then version 1.1 actors must use the Endpoint Event Listener interface of the service in preference, and not call it as an Endpoint Listener. For this reason the Endpoint Listener interface is marked as *Deprecated*. The reason that the Endpoint Event Listener interface should be preferred is that it supports more advanced notification types, such as modification events.

A Topology Manager has knowledge of its local Endpoints and is likely to be only interested in remote Endpoints. It can therefore set the scope to only match remote Endpoint Descriptions. See *Framework UUID* on page 751 for how to limit the scope to local or remote Endpoints. At the

same time, a Topology manager should inform any locally registered Endpoint Event Listener and Endpoint Listener services about Endpoints that it has created or deleted.

This architecture allows many different use cases. For example, a bundle could display a map of the topology by registering an Endpoint Event Listener with a scope for local Endpoints. Another example is the use of SLP to announce local Endpoints to a network and to discover remote Endpoints from other parties on this network.

An instance of this design is shown in Figure 122.5 on page 758. In this figure, there are 3 frameworks that collaborate through some discovery bundle. The Top framework has created an Endpoint and decides to notify all Endpoint Event Listeners and Endpoint Listeners registered in this framework that are scoped to this new Endpoint. Local bundle D has set its scope to all Endpoint Descriptions that originate from its local framework, it therefore receives the Endpoint Description from T. Bundle D then sends the Endpoint Description to all its peers on the network.

In the Quark framework, the manager bundle T has expressed an interest by setting its scope to a filter that matches the Endpoint Description from the Top framework. When the bundle D on the Quark framework receives the Endpoint Description from bundle D on the Top framework, it matches it against all local Endpoint Event Listener's scope. In this case, the local manager bundle T matches and is given the Endpoint Description. The manager then uses the Remote Service Admin service to import the exported service described by the given Endpoint Description.

Figure 122.5 Endpoint Discovery Architecture. T=Topology Manager, D=Discovery

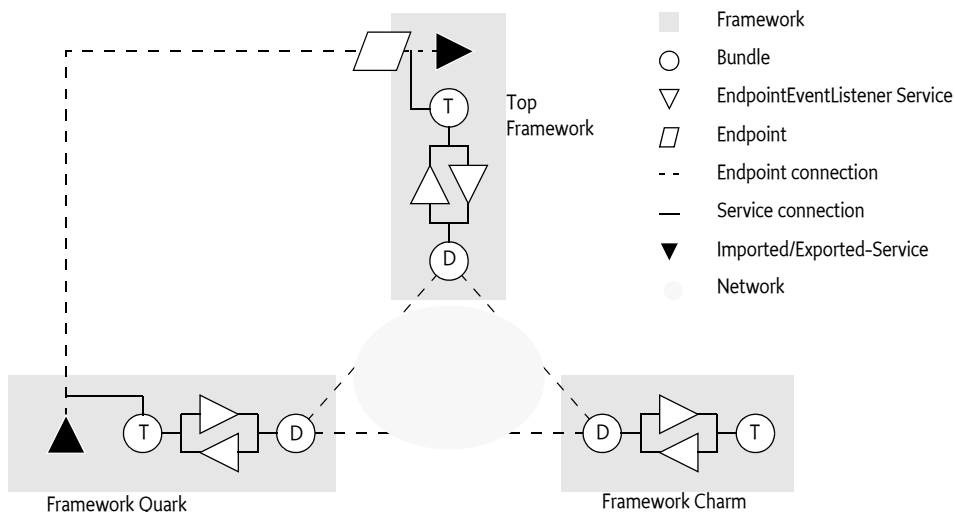

The previous description is just one of the possible usages of the Endpoint Event Listener. For example, the discovery bundles could communicate the scopes to their peers. These peers could then register an Endpoint Event Listener per peer, minimizing the network traffic because Endpoint Descriptions do not have to be broadcast to all peers.

Another alternative usage is described in *Endpoint Description Extender Format* on page 763. In this chapter the extender pattern is used to retrieve Endpoint Descriptions from resources in locally active bundles.

### 122.6.1 Scope and Filters

An Endpoint Event Listener or Endpoint Listener service is registered with the `ENDPOINT_LISTENER_SCOPE` service property. This property, which is `String+`, must be set and must contain at least one filter. If there is not at least one filter, then that Endpoint Event Listener or Endpoint Listener must not receive any Endpoint Descriptions.

Each filter in the scope is applied against the properties of the Endpoint Description until one succeeds. Only if one succeeds is the Endpoint informed about the existence of an Endpoint.

The Endpoint Description is designed to reflect the properties of the imported service, there is therefore a correspondence with the filters that are used by bundles that are listening for service registrations. The purpose of this design is to match the filter available through Listener Hook services, see *On Demand* on page 761.

However, the purpose of the filters is more generic than just this use case. It can also be used to specify the interest in local Endpoints or remote Endpoints. For example, Topology Managers are only interested in remote Endpoints while discoverers are only interested in local Endpoints. It is easy to discriminate between local and remote by filtering on the `endpoint.framework.uuid` property. Endpoint Descriptions contain the Universally Unique ID (UUID) of the originating framework. This UUID must be available from the local framework as well. See *Framework UUID* on page 751.

### 122.6.2 Endpoint Event Listener Interface

The `EndpointEventListener` interface has the following method:

- `endpointChanged(EndpointEvent,String)` – Notify the Endpoint Event Listener of changes to an Endpoint. The change could entail the addition or removal of an Endpoint or the modification of the properties of an existing Endpoint. Multiple identical events should be counted as a single such event.

These methods must only be called if the Endpoint Event Listener service has a filter in its scope that matches the Endpoint Description properties.

The Endpoint Event Listener interface is *idempotent*. Endpoint Description Providers must inform an Endpoint Event Listener service (and its deprecated predecessor Endpoint Listener service) that is registered of all their matching Endpoints. The only way to find out about all available Endpoints is to register an Endpoint Event Listener (or Endpoint Listener) that is then informed by all available Endpoint Description Providers of their known Endpoint Descriptions that match their scope.

### 122.6.3 Endpoint Listener Interface

The `EndpointListener` interface is marked as `Deprecated` because the `EndpointEventListener` interface must be used in preference when both are implemented by the same object. The `EndpointEvent` interface has the following methods:

- `endpointAdded(EndpointDescription,String)` – Notify the Endpoint Listener of a new Endpoint Description. The second parameter is the filter that matched the Endpoint Description. Registering the same Endpoint multiple times counts as a single registration.
- `endpointRemoved(EndpointDescription,String)` – Notify the Endpoint Listener that the provided Endpoint Description is no longer available.

These methods must only be called if the Endpoint Listener service has a filter in its scope that matches the Endpoint Description properties. The reason for the filter string in the methods is to simplify and speed up matching an Endpoint Description to the cause of interest. For example, if the Listener Hook is used to do on demand import of services, then the filter can be associated with the Listener Info of the hook, see *On Demand* on page 761. If multiple filters in the scope match the Endpoint Description then the first filter in the scope must be passed.

The Endpoint Listener interface is *idempotent*. Endpoint Description Providers must inform an Endpoint Listener service that is registered of all their matching Endpoints.

### 122.6.4 Endpoint Event Listener and Endpoint Listener Implementations

An Endpoint Event Listener service tracks the known Endpoints in its given scope. There are potentially a large number of bundles involved in creating this federated registry of Endpoints. To ensure

that no Endpoint Descriptions are orphaned or unnecessarily missed, an Endpoint Event Listener implementation must follow the following rules:

- *Registration* – The Endpoint Event Listener service is called with an event of type `ADDED` for all known Endpoint Descriptions that the bundles in the local framework are aware of. Similarly, Endpoint Listener services are called with an `endpointAdded(EndpointDescription,String)` method for all these.
- *Tracking providers* – An Endpoint Event Listener or Endpoint Listener must track the bundles that provide it with Endpoint Descriptions. If a bundle that provided Endpoint Descriptions is stopped, all Endpoint Descriptions that were provided by that bundle must be removed. This can be implemented straightforwardly with a Service Factory.
- *Scope modification* – An Endpoint Event Listener or Endpoint Listener is allowed to modify the set of filters in its scope through a service property modification. This modification must result in new and/or existing Endpoint Descriptions to be added, however, existing Endpoints that are no longer in scope are not required to be explicitly removed by their sources. It is the responsibility for the Endpoint Listener to remove these orphaned Endpoint Description from its view.
- *Endpoint mutability* – An Endpoint Description can change its Properties. The way this is handled is different for Endpoint Event Listeners and Endpoint Listeners. An Endpoint Event Listener receives a change event of type `MODIFIED` when the Properties of an existing Endpoint are modified. If the modification means that the Endpoint no longer matches the listener scope an event of type `MODIFIED_ENDMATCH` is sent instead. Endpoint Listener services receive a sequence of `endpointRemoved(EndpointDescription,String)` and `endpointAdded(EndpointDescription,String)` callbacks when the Properties of an Endpoint are modified.

Endpoint Descriptions can be added from different sources and providers of Endpoint Descriptions often use asynchronous and potentially unreliable communications. An implementation must therefore handle the addition of multiple equal Endpoint Descriptions from different sources as well as from the same source. Implementations must not count the number of registrations, a remove operation of an Endpoint Description is final for each source. That is, if source A added Endpoint Description e, then it can only be removed by source A. However, if source A added e multiple times, then it only needs to be removed once. Removals of Endpoint Descriptions that have not been added (or were removed before) should be ignored.

The discovery of Endpoints is a fundamentally indeterministic process and implementations of Endpoint Event Listener services should realize that there are no guarantees that an added Endpoint Description is always describing a valid Endpoint.

## 122.6.5

### Endpoint Description Providers

The Endpoint Event Listener and Endpoint Listener services are based on an asynchronous, unreliable, best effort model because there are few guarantees in a distributed world. It is the task of an Endpoint Description Provider, for example a discovery bundle, to keep the Endpoint Event Listener services up to date of any Endpoint Descriptions the provider is aware of and that match the tracked service's scope.

If an Endpoint Event Listener or Endpoint Listener service is registered, a provider must add all matching Endpoint Descriptions that it is aware of and match the tracked listener's scope. This can be done during registration or asynchronously later. For example, it is possible to use the filters in the scope to request remote systems for any Endpoint Descriptions that match those filters. For expediency reasons, the service registration event should not be delayed until those results return; it is therefore applicable to add these Endpoint Descriptions later when the returns from the remote systems finally arrive.

If a tracked listener service object is advertised as both an Endpoint Event Listener and an Endpoint Listener then the EndpointDescription Provider must ignore the EndpointListener interface, and treat the listener only as an Endpoint Event Listener. Remote Service Admin 1.0 actors will be un-

aware of the `EndpointEventListener` interface, and will treat the service object purely as an `Endpoint Listener`. This restriction ensures that all actors will treat the service either as an `Endpoint Event Listener`, or an `Endpoint Listener`, but never as both. As a result the listener service will not have to disambiguate duplicate events from a single source. If an `Endpoint Description Provider` uses both the `Endpoint Listener` and `Endpoint Event Listener` interfaces of a single service object then the resulting behavior is undefined. The implementation may detect the misuse and throw an `Exception`, process or ignore the events from one of the interfaces, or it may simply corrupt the internal registry of `Endpoints` within the listener.

A tracked `Endpoint Event Listener` or `Endpoint Listener` is allowed to modify its scope by setting new properties on its `Service Registration`. An `Endpoint Description provider` must process the new scope and add any newly matching `Endpoint Descriptions`. It is not necessary to remove any `Endpoint Descriptions` that were added before but no longer match the new scope. Removing those orphaned descriptions is the responsibility of the listener implementation.

It is not necessary to remove any registered `Endpoint Descriptions` when the `Endpoint Event Listener` or `Endpoint Listener` is unregistered; also here it is the responsibility of the listener to do the proper cleanup.

## 122.6.6 On Demand

A common distribution policy is to import services that are being listened for by local bundles. For example, when a bundle opens a `Service Tracker` on the `Log Service`, a `Topology Manager` could be notified and attempt to find a `Log Service` in the local cluster and then import this service in the local `Service Registry`.

The `OSGi` framework provides service hooks for exactly this purpose. A `Topology Manager` can register a `Listener Hook` service and receive the information about bundles that have specified an interests in specific services.

For example, a bundle creates the following `Service Tracker`:

```
ServiceTracker st = new ServiceTracker(context,
    LogService.class.getName() );
st.open();
```

This `Service Tracker` will register a `Service Listener` with the `OSGi` framework. This will cause the framework to add a `ListenerInfo` to any `Listener Hook` services. The `getFilter` method on a `ListenerInfo` object provides a filter that is directly applicable for the `Endpoint Event Listener`'s scope. In the previous example, this would be the filter:

```
(objectClass=org.osgi.service.log.LogService)
```

A `Topology Manager` could verify if this listener is satisfied. That is, if it has at least one service. If no such service could be found, it could then add this filter to its `Endpoint Event Listener`'s scope to detect remote implementations of this service. If such an `Endpoint` is detected, it could then request the import of this service through the `Remote Service Admin` service.

## 122.7 Events

The `Remote Service Admin` service must synchronously inform any `Remote Service Admin Listener` services of events as they happen. Client of the events should return quickly and not perform any but trivial processing in the same thread.

The following event types are defined:

- **EXPORT\_ERROR** - An exported service has run into an unrecoverable error, although the Export Registration has not been closed yet. The event carries the Export Registration as well as the Exception that caused the problem, if present.
- **EXPORT\_REGISTRATION** - The Remote Service Admin has registered a new Export Registration.
- **EXPORT\_UNREGISTRATION** - An Export Registration has been closed, the service is no longer exported and the Endpoint is no longer active when this was the last registration for that service/Endpoint combination.
- **EXPORT\_UPDATE** - An exported service is updated. The service properties have changed.
- **EXPORT\_WARNING** - An exported service is experiencing problems but the Endpoint is still available.
- **IMPORT\_ERROR** - An imported service has run into a fatal error and has been shut down. The Import Registration should be closed by the Topology Manager that created them.
- **IMPORT\_REGISTRATION** - A new Import Registration was created for a potentially existing service/Endpoint combination.
- **IMPORT\_UNREGISTRATION** - An Import Registration was closed, removing the proxy if this was the last registration.
- **IMPORT\_UPDATE** - An imported service is updated. The service properties have changed.
- **IMPORT\_WARNING** - An imported service is experiencing problems but can continue to function.

The following properties are available on the event:

- **getType()** - The type of the event.
- **getException()** - Any exception, if present.
- **getExportReference()** - An export reference, if applicable.
- **getImportReference()** - An import reference, if applicable.
- **getSource()** - The source of the event, the Remote Service Admin service.

### 122.7.1

## Event Admin Mapping

All Remote Service Admin events must be posted, which is asynchronously, to the Event Admin service, if present, under the following topic:

```
org/osgi/service/remoteserviceadmin/<type>
```

Where <type> represents the type of the event, for example **IMPORT\_ERROR**.

The Event Admin event must have the following properties:

- **bundle** - (Bundle) The Remote Service Admin bundle
- **bundle.id** - (Long) The id of the Remote Service Admin bundle.
- **bundle.symbolicname** - (String) The Bundle Symbolic Name of the Remote Service Admin bundle.
- **bundle.version** - (Version) The version of the Remote Service Admin bundle.
- **bundle.signer** - (String[]) Signer of the Remote Service Admin bundle
- **exception** - (Throwable) The Exception, if present. Also reported on the cause property for backward compatibility.
- **exception.class** - (String) The fully-qualified class name of the attached Exception.
- **exception.message** - (String) The message of the attached exception. Only set if the Exception message is not null.
- **endpoint.service.id** - (Long) Remote service id, if present
- **endpoint.framework.uuid** - (String) Remote service's Framework UUID, if present
- **endpoint.id** - (String) The id of the Endpoint, if present
- **objectClass** - (String[]) The interface names, if present

- `service.imported.configs` - (String+) The configuration types of the imported services, if present
- `timestamp` - (Long) The time when the event occurred
- `event` - (RemoteServiceAdminEvent) The RemoteServiceAdminEvent object that caused this event.

## 122.8 Endpoint Description Extender Format

The Endpoint Description Extender format is a possibility to deliver Endpoint Descriptions in bundles. This section defines an XML schema and how to locate XML definition resources that use this schema to define Endpoint Descriptions. The definition resource is a simple property based model that can define the same information as the properties on an imported service. If a bundle with the description is *ready* (ACTIVE or lazy activation and in the STARTING state), then this static description can be disseminated through the Endpoint Event Listeners that have specified an interest in this description. If the bundle is stopped, the corresponding Endpoints must be removed.

XML documents containing remote service descriptions must be specified by the Remote-Service header in the manifest. The structure of the Remote Service header is:

```
Remote-Service ::= header // See Common Header Syntax in Core
```

The value of the header is a comma separated list of paths. A path is:

- A directory if it ends with a solidus (`' \u002F`). A directory is scanned for `*.xml` files.
- A path with wildcards. Such a path can use the wildcards in its last component, as defined in the `findEntries` method.
- A complete path, not having wildcards not ending in a solidus (`' \u002F`).

The Remote-Service header has no architected directives or attributes, unrecognized attributes and directives must be ignored.

A Remote-Service manifest header specified in a fragment must be ignored. However, XML documents referenced by a bundle's Remote-Service manifest header can be contained in attached fragments. The required behavior for this is implemented in the `findEntries` method.

The extender must process each XML document specified in this header. If an XML document specified by the header cannot be located in the bundle and its attached fragments, the extender must log an error message with the Log Service, if present, and continue.

For example:

```
Remote-Service: lib/, remote/osgi/*.dsc, cnf/google.xml
```

This matches all resources in the `lib` directory matching `*.xml`, all resources in the `/remote/osgi` directory that end with `.dsc`, as well as the `google.xml` resource in the `cnf` directory.

The namespace of these XML resources must be:

```
http://www.osgi.org/xmlns/rsa/v1.0.0
```

This namespace describes a set of Endpoint Descriptions, where each Endpoint Description can provide a set of properties. The structure of this schema is:

```
endpoint-descriptions ::= <endpoint-description>*
endpoint-description ::= <property>*
property                ::= ( <array> | <list> | <set> | <xml> )?
array                   ::= <value> *
```

```
list ::= <value> *
set ::= <value> *
xml ::= <*> *
```

This structure is depicted in Figure 122.6 on page 764.

Figure 122.6 Endpoint Description XML Structure

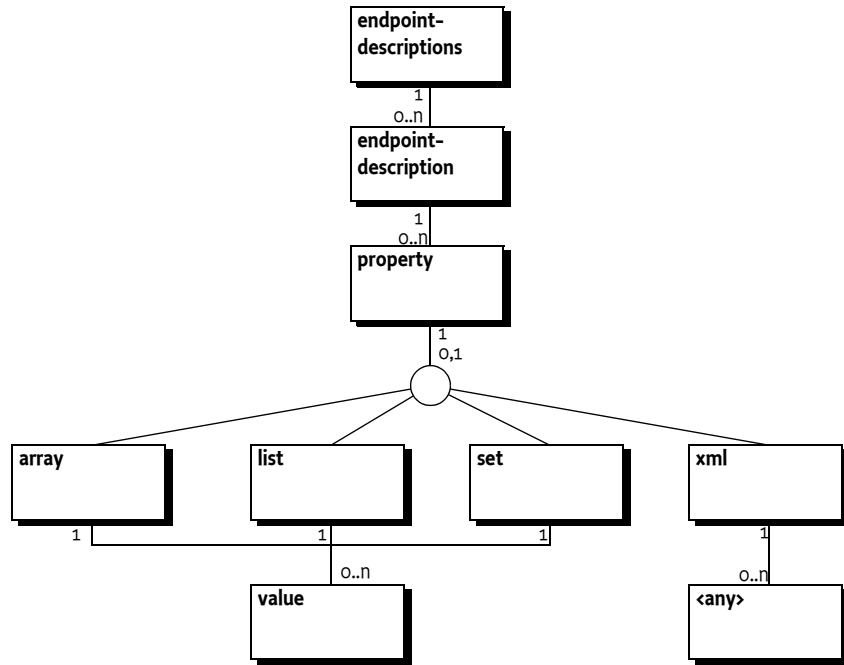

The property element has the attributes listed in table Table 122.2.

Table 122.2 Property Attributes

Attribute	Type	Description
name	String	The required name of the property. The type maps to the XML Schema xsd:string type.



Attribute	Type	Description
value-type	String   long   Long   double   Double   float   Float   int   Integer   byte   Byte   char   Character   boolean   Boolean   short   Short	The optional type name of the property, the default is String. Any value in the value attribute or the value element when collections are used must be converted to the corresponding Java types. If the primitive form, for example byte, is specified for non-array types, then the value must be silently converted to the corresponding wrapper type.
value	String	The value. Must be converted to the specified type if this is not the String type. The value attribute must not be used when the property element has a child element.

A property can have an array, list, set, or xml child element. If a child element is present then it is an error if the value attribute is defined. It is also an error if there is no child element and no value attribute.

The array, list, or set are *multi-valued*. That is, they contain 0 or more value elements. A value element contains text (a string) that must be converted to the given value-type or if not specified, left as is. Conversion must *trim* the leading and trailing white space characters as defined in the Character.isWhitespace method. No trimming must be done for strings. An array of primitive integers like int[] {1,42,97} can be encoded as follows:

```
<property name="integers" value-type="int">
  <array>
    <value> 1</value>
    <value>42</value>
    <value>97</value>
  </array>
</property>
```

The xml element is used to convey XML from other namespaces, it is allowed to contain one foreign XML root element, with any number of children, that will act as the root element of an XML document. This root element will be included in the corresponding property as a string. The XML element must be a valid XML document but not contain the XML processing instructions, the part between the <? and ?>. The value-type of the property must be String or not set when an xml element is used, using another type is invalid.

The xml element can be used to embed configuration information, making the Endpoint Description self contained.

The following is an example of an endpoint-descriptions resource.

```
<?xml version="1.0" encoding="UTF-8"?>
<endpoint-descriptions xmlns="http://www.osgi.org/xmlns/rsa/v1.0.0">
  <endpoint-description>
    <property name="service.intents">
      <list>
        <value>SOAP</value>
        <value>HTTP</value>
      </list>
    </property>
    <property name="endpoint.id" value="http://ws.acme.com:9000/hello"/>
    <property name="endpoint.package.version.com.acme" value="4.2"/>
    <property name="objectClass">
      <array>
        <value>com.acme.Foo</value>
      </array>
    </property>
    <property name="service.imported.configs" value="com.acme"/>
    <property name="com.acme.ws.xml">
      <xml>
        <config xmlns="http://acme.com/defs">
          <port>1029</port>
          <host>www.acme.com</host>
        </config>
      </xml>
    </property>
  </endpoint-description>
</endpoint-descriptions>
```

Besides being in a separate resource, the static configuration as described here could also be part of a larger XML file. In that case the parser must ignore elements not part of the `http://www.osgi.org/xmlns/rsa/v1.0.0` namespace schema.

## 122.8.1 XML Schema

This namespace of the schema is:

`http://www.osgi.org/xmlns/rsa/v1.0.0`

```
<schema xmlns="http://www.w3.org/2001/XMLSchema"
  xmlns:rsa="http://www.osgi.org/xmlns/rsa/v1.0.0"
  targetNamespace="http://www.osgi.org/xmlns/rsa/v1.0.0"
  elementFormDefault="qualified" version="1.0.1">

  <annotation>
    <documentation xml:lang="en">
      This is the XML Schema for endpoint descriptions used by
      the Remote Service Admin Specification. Endpoint descriptions
      are used to describe remote services to a client in cases
      where a real live Discovery system isn't used. An extender,
      such as a local Discovery Service can look for service
      descriptions in installed bundles and inform the Topology
      Manager of these remote services. The Topology Manager can then
      instruct the Remote Service Admin to create client proxies for
      these services.
    </documentation>
  </annotation>

  <element name="endpoint-descriptions" type="rsa:Tendpoint-descriptions" />

  <complexType name="Tendpoint-descriptions">
    <sequence>
```

```

<element name="endpoint-description" type="rsa:Tendpoint-description"
  minOccurs="1" maxOccurs="unbounded" />
  <!--
    It is non-deterministic, per W3C XML Schema 1.0:
    http://www.w3.org/TR/xmlschema-1/#cos-nonambig to use
    namespace="##any" below.
  -->
  <any namespace="##other" minOccurs="0" maxOccurs="unbounded"
    processContents="lax" />
</sequence>
<anyAttribute processContents="lax" />
</complexType>

<complexType name="Tendpoint-description">
  <annotation>
    <documentation xml:lang="en">
      A Distribution Provider can register a proxy with the properties
      provided. Whether or not it is instructed to do so, is up to the
      Topology Manager. If any 'intents' properties are specified then the
      Distribution Provider should only register a proxy if it can support
      those intents.
    </documentation>
  </annotation>
  <sequence>
    <element name="property" type="rsa:Tproperty" minOccurs="1"
      maxOccurs="unbounded" />
    <any namespace="##other" minOccurs="0" maxOccurs="unbounded"
      processContents="lax" />
  </sequence>
  <anyAttribute processContents="lax" />
</complexType>

<complexType name="Tproperty" mixed="true">
  <sequence>
    <choice minOccurs="0" maxOccurs="1">
      <element name="array" type="rsa:Tmulti-value"/>
      <element name="list" type="rsa:Tmulti-value"/>
      <element name="set" type="rsa:Tmulti-value"/>
      <element name="xml" type="rsa:Txml"/>
    </choice>
    <any namespace="##other" minOccurs="0" maxOccurs="unbounded"
      processContents="lax" />
  </sequence>
  <attribute name="name" type="string" use="required" />
  <attribute name="value" type="string" use="optional" />
  <attribute name="value-type" type="rsa:Tvalue-types" default="String" use="optional" />
  <anyAttribute processContents="lax" />
</complexType>

<complexType name="Tmulti-value">
  <sequence>
    <element name="value" minOccurs="0" maxOccurs="unbounded" type="rsa:Tvalue"/>
    <any namespace="##other" minOccurs="0" maxOccurs="unbounded"
      processContents="lax" />
  </sequence>
  <anyAttribute processContents="lax" />
</complexType>

<complexType name="Tvalue" mixed="true">
  <sequence>
    <element name="xml" minOccurs="0" maxOccurs="1" type="rsa:Txml"/>
    <any namespace="##other" minOccurs="0" maxOccurs="unbounded"
      processContents="lax" />
  </sequence>
  <anyAttribute processContents="lax" />
</complexType>

<!-- Specifies the data type of a property or of the elements in a multi-value
  property. Numerical and boolean values are trimmed before they are processed.
  Simple types are automatically boxed if needed. Only the array data type
  allows for simple type values. When specifying a simple type on any other
  type of property it will automatically be boxed. -->
<simpleType name="Tvalue-types">
  <restriction base="string">
    <enumeration value="String" />
  </restriction>
</simpleType>

```

```

    <enumeration value="long" />
    <enumeration value="Long" />
    <enumeration value="double" />
    <enumeration value="Double" />
    <enumeration value="float" />
    <enumeration value="Float" />
    <enumeration value="int" />
    <enumeration value="Integer" />
    <enumeration value="byte" />
    <enumeration value="Byte" />
    <enumeration value="char" />
    <enumeration value="Character" />
    <enumeration value="boolean" />
    <enumeration value="Boolean" />
    <enumeration value="short" />
    <enumeration value="Short" />
  </restriction>
</simpleType>

<!-- This complex type allows literal XML to be specified in an <xml/> tag (which
is more convenient than putting it in a CDATA section).
The embedded XML must be well-formed and not be in the rsa namespace. It will
be put in a String value of a property or in an element of a multi-value
property of base type String. The XML will be prefixed with the standard
<?XML ?> header which is copied from the enclosing document. Hence it will
carry the same version and encoding as the document in the rsa namespace. -->
<complexType name="Txml">
  <sequence>
    <any namespace="##other" minOccurs="1" maxOccurs="1"
      processContents="lax" />
  </sequence>
  <anyAttribute processContents="lax" />
</complexType>

<attribute name="must-understand" type="boolean" default="false">
  <annotation>
    <documentation xml:lang="en">
      This attribute should be used by extensions to documents
      to require that the document consumer understand the
      extension.
    </documentation>
  </annotation>
</attribute>
</schema>

```

## 122.9 Capability Namespaces

### 122.9.1 Local Discovery Extender

A bundle containing Endpoint Description Extender resources can indicate its dependency on the Remote Service Admin extender by declaring a requirement on the `osgi.extender` namespace.

```

Require-Capability: osgi.extender;
  filter:=("&(osgi.extender=osgi.remoteserviceadmin.localdiscovery)
  (version>=1.0) (! (version>=2.0))")

```

With this constraint declared a bundle that depends on the extender will fail to resolve if no extender is present in the framework.

Implementations of this specification must provide this extender capability at version 1.0 as follows:

```

Provide-Capability: osgi.extender;
  osgi.extender="osgi.remoteserviceadmin.localdiscovery";
  version:Version="1.0";
  uses:="org.osgi.service.remoteserviceadmin"

```

The reason that the extender capability is declared at version 1.0 is because the extender is unchanged from version 1.0 of this specification.

### 122.9.2 Discovery Provider Capability

Discovery Providers use the `osgi.remoteserviceadmin.discovery` namespace to declare themselves as such. The version defined for this namespace indicates the version of this specification that the discovery provider supports.

This namespace has a defined attribute, `protocols` of type `List<String>`, which contains a list of the discovery protocols supported by the discovery provider. Local discovery providers (using the *Endpoint Description Extender Format* on page 763), should use the value `local` to indicate that they support this. Additionally, it defines a `version` attribute. Other values for the `protocols` attribute are implementation specific.

Table 122.3 *osgi.remoteserviceadmin.discovery* Namespace

Name	Kind	M/O	Type	Syntax	Description
protocols	CA	M	List<String>	symbolic-name	The discovery protocols supported. A value of <code>local</code> indicates support for the <i>Endpoint Description Extender Format</i> on page 763.
version	CA	M	Version	version	This version must correspond to the version of the Remote Service Admin specification.

Example: A discovery provider that provides local and SLP discovery:

```
Provide-Capability: osgi.remoteserviceadmin.discovery;
  protocols:List<String>="SLP,local"; version:Version=1.1
```

### 122.9.3 Distribution Provider Capability

Distribution providers advertise their supported distribution mechanisms using configuration types. These are selected at runtime using the `service.exported.configs` service property. Distribution providers can use the `osgi.remoteserviceadmin.distribution` namespace with attribute `configs`, of type `List<String>`, to advertise the supported config types.

Table 122.4 *osgi.remoteserviceadmin.distribution* Namespace

Name	Kind	M/O	Type	Syntax	Description
configs	CA	M	List<String>	symbolic-name	Supported configuration types. See <i>Endpoint Description</i> on page 748.
version	CA	M	Version	version	This version must correspond to the version of the Remote Service Admin specification.

Example: A Distribution provider that supports the `org.acme.jaxws` and `org.acme.jaxrs` configuration types:

```
Provide-Capability: osgi.remoteserviceadmin.distribution;
  configs:List<String>="org.acme.jaxws,org.acme.jaxrs"; version:Version=1.1
```

### 122.9.4 Topology Manager Capability

Remote Service Admin topology managers may use different policies when determining which services to export and/or import. Topology managers use the namespace `osgi.remoteserviceadmin.topology` to declare this behavior. This namespace defines the policy at-

tribute of type `List<String>`. Values are implementation specific, but example definitions can be found at *Example Use Cases* on page 747.

Table 122.5 *osgi.remoteserviceadmin.topology Namespace*

Name	Kind	M/O	Type	Syntax	Description
policy	CA	M	List<String>	symbolic-name	The policy used for importing and exporting services. In general the policy is implementation specific.
version	CA	M	Version	version	This version must correspond to the version of the Remote Service Admin specification.

Example: A Topology manager that supports a *promiscuous* policy:

```
Provide-Capability: osgi.remoteserviceadmin.topology;
  policy:List<String>=promiscuous; version:Version=1.1
```

### 122.9.5 Service Capability

The Distribution Provider provides the *Remote Service Admin* service. To inform tools about this service it must provide the `osgi.service` namespace representing the [RemoteServiceAdmin](#) service. This capability must also declare a uses constraint for the `org.osgi.service.remoteserviceadmin` package:

```
Provide-Capability: osgi.service;
  objectClass:List<String>=
    "org.osgi.service.remoteserviceadmin.RemoteServiceAdmin";
  uses:"org.osgi.service.remoteserviceadmin"
```

This capability must follow the rules defined for the *osgi.service Namespace* on page 997.

## 122.10 Advice to implementations

This section is not intended to be normative, but offers advice to implementations as to how the complexity of supporting both the new Endpoint Event Listener and Endpoint Listener services can be managed and minimized. This advice applies to both Discovery Providers and Topology Managers implementing Remote Service Admin 1.1.

### 122.10.1 Notifying listeners

Endpoint Event Listeners and Endpoint Listeners have a very similar behavior and lifecycle. They also use the same property names to define their scope filter. It is therefore relatively simple for an Endpoint Description Provider to notify both Endpoint Listener and Endpoint Event Listeners using a single code path.

One possible mechanism is to track both the listener types using the same Service Tracker. If the tracked Service Reference advertises the `EndpointEventListener` interface then it must be treated as an Endpoint Event Listener. If not then the Endpoint Listener service can be wrapped in an adapter that converts Endpoint Event Listener events into the appropriate Endpoint Listener calls. The main notification code path can then treat every listener as an Endpoint Event Listener.

### 122.10.2 Receiving Endpoint lifecycle notifications

The Remote Service Admin 1.1 specification is backward compatible with version 1.0, meaning that version 1.1 actors must register an Endpoint Listener service. There is no restriction requiring this listener to be the same service as the Endpoint Event Listener, however there is a significant advantage to combining the listeners into a single service registration.

By making the two listeners a single service object a bundle can guarantee that it will not receive multiple notifications for the same event. If the service registrations are separate then Endpoint Description Providers will see two separate listeners, and notify them both. As a single service registration only one event will occur, and using the highest mutually supported version of the Remote Service Admin Specification.

## 122.11 Security

From a security point of view distribution is a significant threat. A Distribution Provider requires very significant capabilities to be able to proxy services. In many situations it will be required to grant the distribution provider All Permission. It is therefore highly recommended that Distribution Providers use trusted links and ensure that it is not possible to attack a system through the Remote Services Admin service and used discovery protocols.

### 122.11.1 Import and Export Registrations

Import and Export Registrations are *capabilities*. That is, they can only be obtained when the caller has the proper permissions but once obtained they are no longer checked. The caller should therefore be careful to share those objects with other bundles. Export and Import References are free to share.

### 122.11.2 Endpoint Permission

The Remote Service Admin implementation requires a large set of permissions because it must be able to distribute potentially any service. Giving these extensive capabilities to all Topology Managers would make it harder to developer general Topology Managers that implements specific scenarios. For this reason, this specification provides an Endpoint Permission.

When an Endpoint Permission must be verified, it must be created with an Endpoint Description as argument, like:

```
sm.checkPermission( new EndpointPermission(anEndpoint, localUUID, READ) );
```

The standard name and action constructor is used to define a permission. The name argument is a filter expression. The filter for an Endpoint Permission is applied to the properties of an Endpoint Description. The localUUID must map to the UUID of the framework of the caller of this constructor, see *Framework UUID* on page 751. This localUUID is used to allow a the permissions to use the <<LOCAL>> magic name in the permission filter to refer to the local framework.

The filter expression can use the following magic value:

- <<LOCAL>> - This value represents the framework UUID of the framework that this bundle belongs to. The following example restricts the visibility to descriptions of local Endpoints:

```
ALLOW {
    ... EndpointPermission
        "(endpoint.framework.uuid=<<LOCAL>>)"
        "READ" }
```

An Endpoint Permission that has the actions listed in the following table.

Table 122.6 *Endpoint Permission Actions*

Action	Methods	Description
IMPORT	<code>importService(EndpointDescription)</code>	Import an Endpoint
EXPORT	<code>exportService(ServiceReference,Map)</code>	Export a service

Action	Methods	Description
READ	<a href="#">getExportedServices()</a> <a href="#">getImportedEndpoints()</a> <a href="#">remoteAdminEvent(RemoteServiceAdminEvent)</a>	See the presence of distributed services. The IMPORT and EXPORT action imply READ. Distribution of events to the Remote Service Admin Listener. The Remote Service Admin must verify that the listener's bundle has the proper permission. No events should be delivered that are not implied.

## 122.12 org.osgi.service.remoteserviceadmin

Remote Service Admin Package Version 1.1.

Bundles wishing to use this package must list the package in the Import-Package header of the bundle's manifest. This package has two types of users: the consumers that use the API in this package and the providers that implement the API in this package.

Example import for consumers using the API in this package:

```
Import-Package: org.osgi.service.remoteserviceadmin; version="[1.1,2.0]"
```

Example import for providers implementing the API in this package:

```
Import-Package: org.osgi.service.remoteserviceadmin; version="[1.1,1.2]"
```

### 122.12.1 Summary

- `EndpointDescription` - A description of an endpoint that provides sufficient information for a compatible distribution provider to create a connection to this endpoint An Endpoint Description is easy to transfer between different systems because it is property based where the property keys are strings and the values are simple types.
- `EndpointEvent` - An Endpoint Event.
- `EndpointEventListener` - A white board service that represents a listener for endpoints.
- `EndpointListener` - Deprecated white board service that represents a listener for endpoints.
- `EndpointPermission` - A bundle's authority to export, import or read an Endpoint.
- `ExportReference` - An Export Reference associates a service with a local endpoint.
- `ExportRegistration` - An Export Registration associates a service to a local endpoint.
- `ImportReference` - An Import Reference associates an active proxy service to a remote endpoint.
- `ImportRegistration` - An Import Registration associates an active proxy service to a remote endpoint.
- `RemoteConstants` - Provide the definition of the constants used in the Remote Service Admin specification.
- `RemoteServiceAdmin` - A Remote Service Admin manages the import and export of services.
- `RemoteServiceAdminEvent` - Provides the event information for a Remote Service Admin event.
- `RemoteServiceAdminListener` - A RemoteServiceAdminEvent listener is notified synchronously of any export or import registrations and unregistrations.

### 122.12.2 public class EndpointDescription

A description of an endpoint that provides sufficient information for a compatible distribution provider to create a connection to this endpoint An Endpoint Description is easy to transfer between different systems because it is property based where the property keys are strings and the values are simple types. This allows it to be used as a communications device to convey available end-



point information to nodes in a network. An Endpoint Description reflects the perspective of an *importer*. That is, the property keys have been chosen to match filters that are created by client bundles that need a service. Therefore the map must not contain any `service.exported.*` property and must contain the corresponding `service.imported.*` ones. The `service.intents` property must contain the intents provided by the service itself combined with the intents added by the exporting distribution provider. Qualified intents appear fully expanded on this property.

*Concurrency* Immutable

#### 122.12.2.1 **public EndpointDescription(Map<String,?> properties)**

*properties* The map from which to create the Endpoint Description. The keys in the map must be type String and, since the keys are case insensitive, there must be no duplicates with case variation.

- Create an Endpoint Description from a Map.

The `endpoint.id`, `service.imported.configs` and `objectClass` properties must be set.

*Throws* IllegalArgumentException– When the properties are not proper for an Endpoint Description.

#### 122.12.2.2 **public EndpointDescription(ServiceReference<?> reference,Map<String,?> properties)**

*reference* A service reference that can be exported.

*properties* Map of properties. This argument can be null. The keys in the map must be type String and, since the keys are case insensitive, there must be no duplicates with case variation.

- Create an Endpoint Description based on a Service Reference and a Map of properties. The properties in the map take precedence over the properties in the Service Reference.

This method will automatically set the `endpoint.framework.uuid` and `endpoint.service.id` properties based on the specified Service Reference as well as the `service.imported` property if they are not specified as properties.

The `endpoint.id`, `service.imported.configs` and `objectClass` properties must be set.

*Throws* IllegalArgumentException– When the properties are not proper for an Endpoint Description

#### 122.12.2.3 **public boolean equals(Object other)**

*other* The EndpointDescription object to be compared.

- Compares this EndpointDescription object to another object.

An Endpoint Description is considered to be **equal to** another Endpoint Description if their ids are equal.

*Returns* true if object is a EndpointDescription and is equal to this object; false otherwise.

#### 122.12.2.4 **public List<String> getConfigurationTypes()**

- Returns the configuration types. A distribution provider exports a service with an endpoint. This endpoint uses some kind of communications protocol with a set of configuration parameters. There are many different types but each endpoint is configured by only one configuration type. However, a distribution provider can be aware of different configuration types and provide synonyms to increase the change a receiving distribution provider can create a connection to this endpoint. This value of the configuration types is stored in the `RemoteConstants.SERVICE_IMPORTED_CONFIGS` service property.

*Returns* An unmodifiable list of the configuration types used for the associated endpoint and optionally synonyms.

#### 122.12.2.5 **public String getFrameworkUUID()**

- Return the framework UUID for the remote service, if present. The value of the remote framework UUID is stored in the `RemoteConstants.ENDPOINT_FRAMEWORK_UUID` endpoint property.

*Returns* Remote Framework UUID, or null if this endpoint is not associated with an OSGi framework having a framework UUID.

#### 122.12.2.6 **public String getId()**

- Returns the endpoint's id. The id is an opaque id for an endpoint. No two different endpoints must have the same id. Two Endpoint Descriptions with the same id must represent the same endpoint. The value of the id is stored in the RemoteConstants.ENDPOINT\_ID property.

*Returns* The id of the endpoint, never null. The returned value has leading and trailing whitespace removed.

#### 122.12.2.7 **public List<String> getIntentents()**

- Return the list of intents implemented by this endpoint. The intents are based on the service.intents on an imported service, except for any intents that are additionally provided by the importing distribution provider. All qualified intents must have been expanded. This value of the intents is stored in the RemoteConstants.SERVICE\_INTENTS service property.

*Returns* An unmodifiable list of expanded intents that are provided by this endpoint.

#### 122.12.2.8 **public List<String> getInterfaces()**

- Provide the list of interfaces implemented by the exported service. The value of the interfaces is derived from the objectClass property.

*Returns* An unmodifiable list of Java interface names implemented by this endpoint.

#### 122.12.2.9 **public Version getPackageVersion(String packageName)**

*packageName* The name of the package for which a version is requested.

- Provide the version of the given package name. The version is encoded by prefixing the given package name with endpoint.package.version., and then using this as an endpoint property key. For example:

```
endpoint.package.version.com.acme
```

The value of this property is in String format and will be converted to a Version object by this method.

*Returns* The version of the specified package or Version.emptyVersion if the package has no version in this Endpoint Description.

*Throws* IllegalArgumentException– If the version property value is not String.

#### 122.12.2.10 **public Map<String, Object> getProperties()**

- Returns all endpoint properties.

*Returns* An unmodifiable map referring to the properties of this Endpoint Description.

#### 122.12.2.11 **public long getServiceId()**

- Returns the service id for the service exported through this endpoint. This is the service id under which the framework has registered the service. This field together with the Framework UUID is a globally unique id for a service. The value of the remote service id is stored in the RemoteConstants.ENDPOINT\_SERVICE\_ID endpoint property.

*Returns* Service id of a service or 0 if this Endpoint Description does not relate to an OSGi service.

#### 122.12.2.12 **public int hashCode()**

- Returns a hash code value for the object.

*Returns* An integer which is a hash code value for this object.

**122.12.2.13 public boolean isSameService(EndpointDescription other)**

*other* The Endpoint Description to look at

- Answers if this Endpoint Description refers to the same service instance as the given Endpoint Description. Two Endpoint Descriptions point to the same service if they have the same id or their framework UUIDs and remote service ids are equal.

*Returns* True if this endpoint description points to the same service as the other

**122.12.2.14 public boolean matches(String filter)**

*filter* The filter to test.

- Tests the properties of this EndpointDescription against the given filter using a case insensitive match.

*Returns* true If the properties of this EndpointDescription match the filter, false otherwise.

*Throws* IllegalArgumentException – If filter contains an invalid filter string that cannot be parsed.

**122.12.2.15 public String toString()**

- Returns the string representation of this EndpointDescription.

*Returns* String form of this EndpointDescription.

**122.12.3 public class EndpointEvent**

An Endpoint Event.

EndpointEvent objects are delivered to all registered EndpointEventListener services where the EndpointDescription properties match one of the filters specified in the EndpointEventListener.ENDPOINT\_LISTENER\_SCOPE registration properties of the Endpoint Event Listener.

A type code is used to identify the type of event. The following event types are defined:

- ADDED
- REMOVED
- MODIFIED
- MODIFIED\_ENDMATCH

Additional event types may be defined in the future.

*See Also* EndpointEventListener

*Since* 1.1

*Concurrency* Immutable

**122.12.3.1 public static final int ADDED = 1**

An endpoint has been added.

This EndpointEvent type indicates that a new endpoint has been added. The endpoint is represented by the associated EndpointDescription object.

**122.12.3.2 public static final int MODIFIED = 4**

The properties of an endpoint have been modified.

This EndpointEvent type indicates that the properties of an existing endpoint have been modified. The endpoint is represented by the associated EndpointDescription object and its properties can be

obtained via `EndpointDescription.getProperties()`. The endpoint properties still match the filters as specified in the `EndpointEventListener.ENDPOINT_LISTENER_SCOPE` filter.

#### 122.12.3.3 **public static final int MODIFIED\_ENDMATCH = 8**

The properties of an endpoint have been modified and the new properties no longer match the listener's filter.

This `EndpointEvent` type indicates that the properties of an existing endpoint have been modified and no longer match the filter. The endpoint is represented by the associated `EndpointDescription` object and its properties can be obtained via `EndpointDescription.getProperties()`. As a consequence of the modification the filters as specified in the `EndpointEventListener.ENDPOINT_LISTENER_SCOPE` do not match any more.

#### 122.12.3.4 **public static final int REMOVED = 2**

An endpoint has been removed.

This `EndpointEvent` type indicates that an endpoint has been removed. The endpoint is represented by the associated `EndpointDescription` object.

#### 122.12.3.5 **public EndpointEvent(int type,EndpointDescription endpoint)**

*type* The event type. See `getType()`.

*endpoint* The endpoint associated with the event.

- Constructs a `EndpointEvent` object from the given arguments.

#### 122.12.3.6 **public EndpointDescription getEndpoint()**

- Return the endpoint associated with this event.

*Returns* The endpoint associated with the event.

#### 122.12.3.7 **public int getType()**

- Return the type of this event.

The type values are:

- ADDED
- REMOVED
- MODIFIED
- MODIFIED\_ENDMATCH

*Returns* The type of this event.

### 122.12.4 **public interface EndpointEventListener**

A white board service that represents a listener for endpoints. An Endpoint Event Listener represents a participant in the distributed model that is interested in Endpoint Descriptions. This white board service can be used in many different scenarios. However, the primary use case is to allow a remote manager to be informed of Endpoint Descriptions available in the network and inform the network about available Endpoint Descriptions. Both the network bundle and the manager bundle register an Endpoint Event Listener service. The manager informs the network bundle about Endpoints that it creates. The network bundles then uses a protocol like SLP to announce these local end-points to the network. If the network bundle discovers a new Endpoint through its discovery protocol, then it sends an Endpoint Description to all the Endpoint Listener services that are registered (except its own) that have specified an interest in that endpoint. Endpoint Event Listener services can express their *scope* with the service property `ENDPOINT_LISTENER_SCOPE`. This service property is a list of filters. An Endpoint Description should only be given to a Endpoint Event Listen-

er when there is at least one filter that matches the Endpoint Description properties. This filter model is quite flexible. For example, a discovery bundle is only interested in locally originating Endpoint Descriptions. The following filter ensures that it only sees local endpoints.

```
(org.osgi.framework.uuid=72dc5fd9-5f8f-4f8f-9821-9ebb433a5b72)
```

In the same vein, a manager that is only interested in remote Endpoint Descriptions can use a filter like:

```
(!(org.osgi.framework.uuid=72dc5fd9-5f8f-4f8f-9821-9ebb433a5b72))
```

Where in both cases, the given UUID is the UUID of the local framework that can be found in the Framework properties. The Endpoint Event Listener's scope maps very well to the service hooks. A manager can just register all filters found from the Listener Hook as its scope. This will automatically provide it with all known endpoints that match the given scope, without having to inspect the filter string. In general, when an Endpoint Description is discovered, it should be dispatched to all registered Endpoint Event Listener services. If a new Endpoint Event Listener is registered, it should be informed about all currently known Endpoints that match its scope. If a getter of the Endpoint Listener service is unregistered, then all its registered Endpoint Description objects must be removed. The Endpoint Event Listener models a *best effort* approach. Participating bundles should do their utmost to keep the listeners up to date, but implementers should realize that many endpoints come through unreliable discovery processes. The Endpoint Event Listener supersedes the EndpointListener interface as it also supports notifications around modifications of endpoints.

Since 1.1

Concurrency Thread-safe

#### 122.12.4.1 **public static final String ENDPOINT\_LISTENER\_SCOPE = "endpoint.listener.scope"**

Specifies the interest of this listener with filters. This listener is only interested in Endpoint Descriptions where its properties match the given filter. The type of this property must be String+.

#### 122.12.4.2 **public void endpointChanged(EndpointEvent event,String filter)**

*event* The event containing the details about the change.

*filter* The filter from the ENDPOINT\_LISTENER\_SCOPE that matches (or for EndpointEvent.MODIFIED\_ENDMATCH and EndpointEvent.REMOVED used to match) the endpoint, must not be null.

- Notification that an endpoint has changed. Details of the change is captured in the Endpoint Event provided. This could be that an endpoint was added, removed or modified.

### 122.12.5 **public interface EndpointListener**

Deprecated white board service that represents a listener for endpoints. An Endpoint Listener represents a participant in the distributed model that is interested in Endpoint Descriptions. The Endpoint Listener is called back when matching endpoints are added or removed. Consumers interested in the modification of endpoints, when associated service properties are changed, should use an EndpointEventListener instead. This white board service can be used in many different scenarios. However, the primary use case is to allow a remote manager to be informed of Endpoint Descriptions available in the network and inform the network about available Endpoint Descriptions. Both the network bundle and the manager bundle register an Endpoint Listener service. The manager informs the network bundle about Endpoints that it creates. The network bundles then uses a protocol like SLP to announce these local end-points to the network. If the network bundle discovers a new Endpoint through its discovery protocol, then it sends an Endpoint Description to all the Endpoint Listener services that are registered (except its own) that have specified an interest in that endpoint. Endpoint Listener services can express their *scope* with the service property ENDPOINT\_LISTENER\_SCOPE. This service property is a list of filters. An Endpoint Description should only be given to a Endpoint Listener when there is at least one filter that matches the End-

point Description properties. This filter model is quite flexible. For example, a discovery bundle is only interested in locally originating Endpoint Descriptions. The following filter ensure that it only sees local endpoints.

```
(org.osgi.framework.uuid=72dc5fd9-5f8f-4f8f-9821-9ebb433a5b72)
```

In the same vein, a manager that is only interested in remote Endpoint Descriptions can use a filter like:

```
(!(org.osgi.framework.uuid=72dc5fd9-5f8f-4f8f-9821-9ebb433a5b72))
```

Where in both cases, the given UUID is the UUID of the local framework that can be found in the Framework properties. The Endpoint Listener's scope maps very well to the service hooks. A manager can just register all filters found from the Listener Hook as its scope. This will automatically provide it with all known endpoints that match the given scope, without having to inspect the filter string. In general, when an Endpoint Description is discovered, it should be dispatched to all registered Endpoint Listener services. If a new Endpoint Listener is registered, it should be informed about all currently known Endpoints that match its scope. If a getter of the Endpoint Listener service is unregistered, then all its registered Endpoint Description objects must be removed. The Endpoint Listener models a *best effort* approach. Participating bundles should do their utmost to keep the listeners up to date, but implementers should realize that many endpoints come through unreliable discovery processes.

*Deprecated* As of 1.1. Replaced by EndpointEventListener.

*Concurrency* Thread-safe

#### 122.12.5.1 **public static final String ENDPOINT\_LISTENER\_SCOPE = "endpoint.listener.scope"**

Specifies the interest of this listener with filters. This listener is only interested in Endpoint Descriptions where its properties match the given filter. The type of this property must be String+.

#### 122.12.5.2 **public void endpointAdded(EndpointDescription endpoint,String matchedFilter)**

*endpoint* The Endpoint Description to be published

*matchedFilter* The filter from the ENDPOINT\_LISTENER\_SCOPE that matched the endpoint, must not be null.

- Register an endpoint with this listener. If the endpoint matches one of the filters registered with the ENDPOINT\_LISTENER\_SCOPE service property then this filter should be given as the matchedFilter parameter. When this service is first registered or it is modified, it should receive all known endpoints matching the filter.

#### 122.12.5.3 **public void endpointRemoved(EndpointDescription endpoint,String matchedFilter)**

*endpoint* The Endpoint Description that is no longer valid.

*matchedFilter* The filter from the ENDPOINT\_LISTENER\_SCOPE that matched the endpoint, must not be null.

- Remove the registration of an endpoint. If an endpoint that was registered with the endpointAdded(EndpointDescription, String) method is no longer available then this method should be called. This will remove the endpoint from the listener. It is not necessary to remove endpoints when the service is unregistered or modified in such a way that not all endpoints match the interest filter anymore.

### 122.12.6 **public final class EndpointPermission extends Permission**

A bundle's authority to export, import or read an Endpoint.

- The export action allows a bundle to export a service as an Endpoint.
- The import action allows a bundle to import a service from an Endpoint.

- The read action allows a bundle to read references to an Endpoint.

Permission to read an Endpoint is required in order to detect events regarding an Endpoint. Untrusted bundles should not be able to detect the presence of certain Endpoints unless they have the appropriate EndpointPermission to read the specific service.

*Concurrency* Thread-safe

**122.12.6.1 public static final String EXPORT = "export"**

The action string export. The export action implies the read action.

**122.12.6.2 public static final String IMPORT = "import"**

The action string import. The import action implies the read action.

**122.12.6.3 public static final String READ = "read"**

The action string read.

**122.12.6.4 public EndpointPermission(String filterString,String actions)**

*filterString* The filter string or "\*" to match all endpoints.

*actions* The actions read, import, or export.

- Create a new EndpointPermission with the specified filter.

The filter will be evaluated against the endpoint properties of a requested EndpointPermission.

There are three possible actions: read, import and export. The read action allows the owner of this permission to see the presence of distributed services. The import action allows the owner of this permission to import an endpoint. The export action allows the owner of this permission to export a service.

*Throws* IllegalArgumentException– If the filter has an invalid syntax or the actions are not valid.

**122.12.6.5 public EndpointPermission(EndpointDescription endpoint,String localFrameworkUUID,String actions)**

*endpoint* The requested endpoint.

*localFrameworkUUID* The UUID of the local framework. This is used to support matching the endpoint.framework.uuid endpoint property to the <<LOCAL>> value in the filter expression.

*actions* The actions read, import, or export.

- Creates a new requested EndpointPermission object to be used by code that must perform checkPermission. EndpointPermission objects created with this constructor cannot be added to an EndpointPermission permission collection.

*Throws* IllegalArgumentException– If the endpoint is null or the actions are not valid.

**122.12.6.6 public boolean equals(Object obj)**

*obj* The object to test for equality.

- Determines the equality of two EndpointPermission objects. Checks that specified object has the same name, actions and endpoint as this EndpointPermission.

*Returns* true If obj is a EndpointPermission, and has the same name, actions and endpoint as this EndpointPermission object; false otherwise.

**122.12.6.7 public String getActions()**

- Returns the canonical string representation of the actions. Always returns present actions in the following canonical order: read, import, export.

*Returns* The canonical string representation of the actions.

**122.12.6.8 public int hashCode()**

- Returns the hash code value for this object.

*Returns* Hash code value for this object.

**122.12.6.9 public boolean implies(Permission p)**

*p* The target permission to check.

- Determines if a EndpointPermission object "implies" the specified permission.

*Returns* true if the specified permission is implied by this object; false otherwise.

**122.12.6.10 public PermissionCollection newPermissionCollection()**

- Returns a new PermissionCollection object for storing EndpointPermission objects.

*Returns* A new PermissionCollection object suitable for storing EndpointPermission objects.

**122.12.7 public interface ExportReference**

An Export Reference associates a service with a local endpoint. The Export Reference can be used to reference an exported service. When the service is no longer exported, all methods must return null.

*Concurrency* Thread-safe

*Provider Type* Consumers of this API must not implement this type

**122.12.7.1 public EndpointDescription getExportedEndpoint()**

- Return the Endpoint Description for the local endpoint.

*Returns* The Endpoint Description for the local endpoint. Must be null when the service is no longer exported.

**122.12.7.2 public ServiceReference<?> getExportedService()**

- Return the service being exported.

*Returns* The service being exported. Must be null when the service is no longer exported.

**122.12.8 public interface ExportRegistration**

An Export Registration associates a service to a local endpoint. The Export Registration can be used to delete the endpoint associated with an this registration. It is created with the RemoteServiceAdmin.exportService(ServiceReference,Map) method. When this Export Registration has been closed, all methods must return null.

*Concurrency* Thread-safe

*Provider Type* Consumers of this API must not implement this type

**122.12.8.1 public void close()**

- Delete the local endpoint and disconnect any remote distribution providers. After this method returns, all methods must return null. This method has no effect when this registration has already been closed or is being closed.

**122.12.8.2 public Throwable getException()**

- Return the exception for any error during the export process. If the Remote Service Admin for some reasons is unable to properly initialize this registration, then it must return an exception from this method. If no error occurred, this method must return null. The error must be set before this Export Registration is returned. Asynchronously occurring errors must be reported to the log.



*Returns* The exception that occurred during the initialization of this registration or null if no exception occurred.

### 122.12.8.3 **public ExportReference getExportReference()**

- Return the Export Reference for the exported service.

*Returns* The Export Reference for this registration, or null if this Import Registration is closed.

*Throws* `IllegalStateException`– When this registration was not properly initialized. See `getException()`.

### 122.12.8.4 **public EndpointDescription update(Map<String,?> properties)**

*properties* properties to be merged with the current service properties for the `ServiceReference` represented by this `ExportRegistration`. If null is passed then the original properties passed to `RemoteServiceAdmin.exportService(ServiceReference, Map)` will be used.

- Update the endpoint represented by this `ExportRegistration` and return an updated `EndpointDescription`. If this method returns an updated `EndpointDescription`, then the object returned via `getExportReference()` must also have been updated to return this new object. If this method does not return an updated `EndpointDescription` then the object returned via `getExportReference()` should remain unchanged. When creating the updated `EndpointDescription` the `ServiceReference` originally passed to `RemoteServiceAdmin.exportService(ServiceReference, Map)` must be queried to pick up any changes to its service properties. If this argument is null then the original properties passed when creating this `ExportRegistration` should be used when constructing the updated `EndpointDescription`. Otherwise the new properties should be used, and replace the original properties for subsequent calls to the update method.

*Returns* The updated `EndpointDescription` for this registration or null if there was a failure updating the endpoint. If a failure occurs then it can be accessed using `getException()`.

*Throws* `IllegalStateException`– If this registration is closed, or when this registration was not properly initialized. See `getException()`.

*Since* 1.1

## 122.12.9 **public interface ImportReference**

An Import Reference associates an active proxy service to a remote endpoint. The Import Reference can be used to reference an imported service. When the service is no longer imported, all methods must return null.

*Concurrency* Thread-safe

*Provider Type* Consumers of this API must not implement this type

### 122.12.9.1 **public EndpointDescription getImportedEndpoint()**

- Return the Endpoint Description for the remote endpoint.

*Returns* The Endpoint Description for the remote endpoint. Must be null when the service is no longer imported.

### 122.12.9.2 **public ServiceReference<?> getImportedService()**

- Return the Service Reference for the proxy for the endpoint.

*Returns* The Service Reference to the proxy for the endpoint. Must be null when the service is no longer imported.

## 122.12.10 **public interface ImportRegistration**

An Import Registration associates an active proxy service to a remote endpoint. The Import Registration can be used to delete the proxy associated with an endpoint. It is created with the

RemoteServiceAdmin.importService(EndpointDescription) method. When this Import Registration has been closed, all methods must return null.

*Concurrency* Thread-safe

*Provider Type* Consumers of this API must not implement this type

#### 122.12.10.1 **public void close()**

- Close this Import Registration. This must close the connection to the endpoint and unregister the proxy. After this method returns, all other methods must return null. This method has no effect when this registration has already been closed or is being closed.

#### 122.12.10.2 **public Throwable getException()**

- Return the exception for any error during the import process. If the Remote Service Admin for some reasons is unable to properly initialize this registration, then it must return an exception from this method. If no error occurred, this method must return null. The error must be set before this Import Registration is returned. Asynchronously occurring errors must be reported to the log.

*Returns* The exception that occurred during the initialization of this registration or null if no exception occurred.

#### 122.12.10.3 **public ImportReference getImportReference()**

- Return the Import Reference for the imported service.

*Returns* The Import Reference for this registration, or null if this Import Registration is closed.

*Throws* IllegalStateException– When this registration was not properly initialized. See getException().

#### 122.12.10.4 **public boolean update(EndpointDescription endpoint)**

*endpoint* The updated endpoint

- Update the local service represented by this ImportRegistration. After this method returns the EndpointDescription returned via getImportReference() must have been updated.

*Returns* true if the endpoint was successfully updated, false otherwise. If the update fails then the failure can be retrieved from getException().

*Throws* IllegalStateException– When this registration is closed, or if it was not properly initialized. See getException().

IllegalArgumentException– When the supplied EndpointDescription does not represent the same endpoint as this ImportRegistration.

*Since* 1.1

### 122.12.11 **public class RemoteConstants**

Provide the definition of the constants used in the Remote Service Admin specification.

*Concurrency* Immutable

#### 122.12.11.1 **public static final String ENDPOINT\_FRAMEWORK\_UUID = "endpoint.framework.uuid"**

Endpoint property identifying the universally unique id of the exporting framework. Can be absent if the corresponding endpoint is not for an OSGi service.

The value of this property must be of type String.

#### 122.12.11.2 **public static final String ENDPOINT\_ID = "endpoint.id"**

Endpoint property identifying the id for this endpoint. This service property must always be set.

The value of this property must be of type String.

- 122.12.11.3**      **public static final String ENDPOINT\_PACKAGE\_VERSION\_ = "endpoint.package.version."**
- Prefix for an endpoint property identifying the interface Java package version for an interface. For example, the property `endpoint.package.version.com.acme=1.3` describes the version of the package for the `com.acme.Foo` interface. This endpoint property for an interface package does not have to be set. If not set, the value must be assumed to be 0.
- Since endpoint properties are stored in a case insensitive map, case variants of a package name are folded together.
- The value of properties having this prefix must be of type `String`.
- 122.12.11.4**      **public static final String ENDPOINT\_SERVICE\_ID = "endpoint.service.id"**
- Endpoint property identifying the service id of the exported service. Can be absent or 0 if the corresponding endpoint is not for an OSGi service.
- The value of this property must be of type `Long`.
- 122.12.11.5**      **public static final String REMOTE\_CONFIGS\_SUPPORTED = "remote.configs.supported"**
- Service property identifying the configuration types supported by a distribution provider. Registered by the distribution provider on one of its services to indicate the supported configuration types.
- The value of this property must be of type `String`, `String[]`, or `Collection of String`.
- See Also* Remote Services Specification
- 122.12.11.6**      **public static final String REMOTE\_INTENTS\_SUPPORTED = "remote.intents.supported"**
- Service property identifying the intents supported by a distribution provider. Registered by the distribution provider on one of its services to indicate the vocabulary of implemented intents.
- The value of this property must be of type `String`, `String[]`, or `Collection of String`.
- See Also* Remote Services Specification
- 122.12.11.7**      **public static final String SERVICE\_EXPORTED\_CONFIGS = "service.exported.configs"**
- Service property identifying the configuration types that should be used to export the service. Each configuration type represents the configuration parameters for an endpoint. A distribution provider should create an endpoint for each configuration type that it supports.
- This property may be supplied in the `properties Dictionary` object passed to the `BundleContext.registerService` method. The value of this property must be of type `String`, `String[]`, or `Collection of String`.
- See Also* Remote Services Specification
- 122.12.11.8**      **public static final String SERVICE\_EXPORTED\_INTENTS = "service.exported.intents"**
- Service property identifying the intents that the distribution provider must implement to distribute the service. Intents listed in this property are reserved for intents that are critical for the code to function correctly, for example, ordering of messages. These intents should not be configurable.
- This property may be supplied in the `properties Dictionary` object passed to the `BundleContext.registerService` method. The value of this property must be of type `String`, `String[]`, or `Collection of String`.
- See Also* Remote Services Specification
- 122.12.11.9**      **public static final String SERVICE\_EXPORTED\_INTENTS\_EXTRA = "service.exported.intents.extra"**
- Service property identifying the extra intents that the distribution provider must implement to distribute the service. This property is merged with the `service.exported.intents` property before the

distribution provider interprets the listed intents; it has therefore the same semantics but the property should be configurable so the administrator can choose the intents based on the topology. Bundles should therefore make this property configurable, for example through the Configuration Admin service.

This property may be supplied in the properties Dictionary object passed to the `BundleContext.registerService` method. The value of this property must be of type `String`, `String[]`, or Collection of `String`.

*See Also* Remote Services Specification

**122.12.11.10** **public static final String SERVICE\_EXPORTED\_INTERFACES = "service.exported.interfaces"**

Service property marking the service for export. It defines the interfaces under which this service can be exported. This list must be a subset of the types under which the service was registered. The single value of an asterisk ('\*' \u002A) indicates all the interface types under which the service was registered excluding the non-interface types. It is strongly recommended to only export interface types and not concrete classes due to the complexity of creating proxies for some type of concrete classes.

This property may be supplied in the properties Dictionary object passed to the `BundleContext.registerService` method. The value of this property must be of type `String`, `String[]`, or Collection of `String`.

*See Also* Remote Services Specification

**122.12.11.11** **public static final String SERVICE\_IMPORTED = "service.imported"**

Service property identifying the service as imported. This service property must be set by a distribution provider to any value when it registers the endpoint proxy as an imported service. A bundle can use this property to filter out imported services.

The value of this property may be of any type.

*See Also* Remote Services Specification

**122.12.11.12** **public static final String SERVICE\_IMPORTED\_CONFIGS = "service.imported.configs"**

Service property identifying the configuration types used to import the service. Any associated properties for this configuration types must be properly mapped to the importing system. For example, a URL in these properties must point to a valid resource when used in the importing framework. If multiple configuration types are listed in this property, then they must be synonyms for exactly the same remote endpoint that is used to export this service.

The value of this property must be of type `String`, `String[]`, or Collection of `String`.

*See Also* Remote Services Specification, `SERVICE_EXPORTED_CONFIGS`

**122.12.11.13** **public static final String SERVICE\_INTENTS = "service.intents"**

Service property identifying the intents that this service implement. This property has a dual purpose:

- A bundle can use this service property to notify the distribution provider that these intents are already implemented by the exported service object.
- A distribution provider must use this property to convey the combined intents of: The exporting service, and the intents that the exporting distribution provider adds, and the intents that the importing distribution provider adds.

To export a service, a distribution provider must expand any qualified intents. Both the exporting and importing distribution providers must recognize all intents before a service can be distributed. The value of this property must be of type `String`, `String[]`, or Collection of `String`.

*See Also* Remote Services Specification

**122.12.12 public interface RemoteServiceAdmin**

A Remote Service Admin manages the import and export of services. A Distribution Provider can expose a control interface. This interface allows a Topology Manager to control the export and import of services. The API allows a Topology Manager to export a service, to import a service, and find out about the current imports and exports.

*Concurrency* Thread-safe

*Provider Type* Consumers of this API must not implement this type

**122.12.12.1 public Collection<ExportRegistration> exportService(ServiceReference<?> reference, Map<String, ?> properties)**

*reference* The Service Reference to export.

*properties* The properties to create a local Endpoint that can be implemented by this Remote Service Admin. If this is null, the Endpoint will be determined by the properties on the service. The properties are the same as given for an exported service. They override any properties in the specified Service Reference (case insensitive). The properties objectClass and service.id, in any case variant, are ignored. Those properties in the Service Reference cannot be overridden. This parameter can be null, this should be treated as an empty map.

- Export a service to a given Endpoint. The Remote Service Admin must create an Endpoint from the given description that can be used by other Distribution Providers to connect to this Remote Service Admin and use the exported service. The property keys of a Service Reference are case insensitive while the property keys of the specified properties map are case sensitive. A property key in the specified properties map must therefore override any case variant property key in the properties of the specified Service Reference.

If the caller does not have the appropriate EndpointPermission[endpoint,EXPORT] for an Endpoint, and the Java Runtime Environment supports permissions, then the getException method on the corresponding returned ExportRegistration will return a SecurityException.

*Returns* A Collection of ExportRegistrations for the specified Service Reference and properties. Multiple Export Registrations may be returned because a single service can be exported to multiple Endpoints depending on the available configuration type properties and the intents that they support. The result is never null but may be empty if this Remote Service Admin does not recognize any of the configuration types, or if they Remote Service Admin cannot support the relevant intents.

*Throws* IllegalArgumentException– If any of the properties for this configuration type has a value that is not syntactically correct, or if the service properties and the overlaid properties do not contain a RemoteConstants.SERVICE\_EXPORTED\_INTERFACES entry. This means that implementations must not ignore invalid values for property names that they recognize.

**122.12.12.2 public Collection<ExportReference> getExportedServices()**

- Return the currently active Export References.

If the caller does not have the appropriate EndpointPermission[endpoint,READ] for an Endpoint, and the Java Runtime Environment supports permissions, then returned collection will not contain a reference to the exported Endpoint.

*Returns* A Collection of ExportReferences that are currently active.

**122.12.12.3 public Collection<ImportReference> getImportedEndpoints()**

- Return the currently active Import References.

If the caller does not have the appropriate EndpointPermission[endpoint,READ] for an Endpoint, and the Java Runtime Environment supports permissions, then returned collection will not contain a reference to the imported Endpoint.

*Returns* A Collection of ImportReferences that are currently active.

**122.12.12.4 public ImportRegistration importService(EndpointDescription endpoint)**

*endpoint* The Endpoint Description to be used for import.

- Import a service from an Endpoint. The Remote Service Admin must use the given Endpoint to create a proxy. This method can return null if the service could not be imported.

*Returns* An Import Registration that combines the Endpoint Description and the Service Reference or null if the Endpoint could not be imported.

*Throws* SecurityException– If the caller does not have the appropriate EndpointPermission[endpoint,IMPORT] for the Endpoint, and the Java Runtime Environment supports permissions.

**122.12.13 public class RemoteServiceAdminEvent**

Provides the event information for a Remote Service Admin event.

*Concurrency* Immutable

**122.12.13.1 public static final int EXPORT\_ERROR = 6**

A fatal exporting error occurred. The Export Registration has been closed.

**122.12.13.2 public static final int EXPORT\_REGISTRATION = 2**

Add an export registration. The Remote Service Admin will send this event when it exports a service. When the RemoteServiceAdminListener service is registered, the Remote Service Admin must notify the listener of all existing Export Registrations.

**122.12.13.3 public static final int EXPORT\_UNREGISTRATION = 3**

Remove an export registration. The Remote Service Admin will send this event when it removes the export of a service.

**122.12.13.4 public static final int EXPORT\_UPDATE = 10**

Update an export registration. The Remote Service Admin will send this event when it exports a service.

*Since* 1.1

**122.12.13.5 public static final int EXPORT\_WARNING = 7**

A problematic situation occurred, the export is still active.

**122.12.13.6 public static final int IMPORT\_ERROR = 5**

A fatal importing error occurred. The Import Registration has been closed.

**122.12.13.7 public static final int IMPORT\_REGISTRATION = 1**

Add an import registration. The Remote Service Admin will send this event when it imports a service. When the RemoteServiceAdminListener service is registered, the Remote Service Admin must notify the listener of all existing Import Registrations.

**122.12.13.8 public static final int IMPORT\_UNREGISTRATION = 4**

Remove an import registration. The Remote Service Admin will send this event when it removes the import of a service.

**122.12.13.9 public static final int IMPORT\_UPDATE = 9**

Update an import registration. The Remote Service Admin will send this event when it updates a service.

*Since* 1.1

**122.12.13.10**      **public static final int IMPORT\_WARNING = 8**

A problematic situation occurred, the import is still active.

**122.12.13.11**      **public RemoteServiceAdminEvent(int type, Bundle source, ExportReference exportReference, Throwable exception)**

*type* The event type.

*source* The source bundle, must not be null.

*exportReference* The exportReference, can not be null.

*exception* Any exceptions encountered, can be null.

- Create a Remote Service Admin Event for an export notification.

**122.12.13.12**      **public RemoteServiceAdminEvent(int type, Bundle source, ImportReference importReference, Throwable exception)**

*type* The event type.

*source* The source bundle, must not be null.

*importReference* The importReference, can not be null.

*exception* Any exceptions encountered, can be null.

- Create a Remote Service Admin Event for an import notification.

**122.12.13.13**      **public Throwable getException()**

- Return the exception for this event.

*Returns* The exception or null.

**122.12.13.14**      **public ExportReference getExportReference()**

- Return the Export Reference for this event.

*Returns* The Export Reference or null.

**122.12.13.15**      **public ImportReference getImportReference()**

- Return the Import Reference for this event.

*Returns* The Import Reference or null.

**122.12.13.16**      **public Bundle getSource()**

- Return the bundle source of this event.

*Returns* The bundle source of this event.

**122.12.13.17**      **public int getType()**

- Return the type of this event.

*Returns* The type of this event.

**122.12.14**      **public interface RemoteServiceAdminListener**

A RemoteServiceAdminEvent listener is notified synchronously of any export or import registrations and unregistrations.

If the Java Runtime Environment supports permissions, then filtering is done. RemoteServiceAdminEvent objects are only delivered to the listener if the bundle which defines the listener object's

class has the appropriate EndpointPermission[endpoint,READ] for the endpoint referenced by the event.

*See Also* RemoteServiceAdminEvent

*Concurrency* Thread-safe

#### 122.12.14.1 **public void remoteAdminEvent(RemoteServiceAdminEvent event)**

*event* The RemoteServiceAdminEvent object.

- Receive notification of any export or import registrations and unregistrations as well as errors and warnings.

## 122.13 org.osgi.service.remoteserviceadmin.namespace

Remote Service Admin Namespaces Version 1.0.

Bundles should not need to import this package at runtime since all the types in this package just contain constants for capability and requirement namespaces specified by the OSGi Alliance.

### 122.13.1 Summary

- DiscoveryNamespace - Remote Services Discovery Provider Capability and Requirement Namespace.
- DistributionNamespace - Remote Services Distribution Provider Capability and Requirement Namespace.
- TopologyNamespace - Remote Services Topology Manager Capability and Requirement Namespace.

### 122.13.2 **public final class DiscoveryNamespace extends Namespace**

Remote Services Discovery Provider Capability and Requirement Namespace.

This class defines the names for the attributes and directives for this namespace.

*Concurrency* Immutable

#### 122.13.2.1 **public static final String CAPABILITY\_PROTOCOLS\_ATTRIBUTE = "protocols"**

The capability attribute used to specify the discovery protocols supported by this discovery provider. The value of this attribute must be of type String or List<String>.

#### 122.13.2.2 **public static final String DISCOVERY\_NAMESPACE = "osgi.remoteserviceadmin.discovery"**

Namespace name for Remote Services discovery provider capabilities and requirements.

### 122.13.3 **public final class DistributionNamespace extends Namespace**

Remote Services Distribution Provider Capability and Requirement Namespace.

This class defines the names for the attributes and directives for this namespace.

*Concurrency* Immutable

#### 122.13.3.1 **public static final String CAPABILITY\_CONFIGS\_ATTRIBUTE = "configs"**

The capability attribute used to specify the config types supported by this distribution provider. The value of this attribute must be of type String or List<String>.



**122.13.3.2**      **public static final String DISTRIBUTION\_NAMESPACE = "osgi.remoteserviceadmin.distribution"**  
 Namespace name for Remote Services distribution provider capabilities and requirements.

**122.13.4**      **public final class TopologyNamespace**  
**extends Namespace**

Remote Services Topology Manager Capability and Requirement Namespace.

This class defines the names for the attributes and directives for this namespace.

*Concurrency* Immutable

**122.13.4.1**      **public static final String CAPABILITY\_POLICY\_ATTRIBUTE = "policy"**

The capability attribute used to specify the policy or policies supported by this topology manager. The value of this attribute must be of type `String` or `List<String>`. Policy names are typically implementation specific, however the Remote Services Specification defines the *promiscuous* and *fail-over* policies for common use cases.

**122.13.4.2**      **public static final String FAIL\_OVER\_POLICY = "fail-over"**

The attribute value for Topology managers with a fail-over policy

*See Also* `TopologyNamespace.CAPABILITY_POLICY_ATTRIBUTE`

**122.13.4.3**      **public static final String PROMISCUOUS\_POLICY = "promiscuous"**

The attribute value for Topology managers with a promiscuous policy

*See Also* `TopologyNamespace.CAPABILITY_POLICY_ATTRIBUTE`

**122.13.4.4**      **public static final String TOPOLOGY\_NAMESPACE = "osgi.remoteserviceadmin.topology"**

Namespace name for Remote Services topology manager capabilities and requirements.

## 122.14      References

- [1] *OSGi Service Property Namespace*  
<http://www.osgi.org/Specifications/ServicePropertyNamespace>
- [2] *UUIDs*  
[http://en.wikipedia.org/wiki/Universally\\_Unique\\_Identifier](http://en.wikipedia.org/wiki/Universally_Unique_Identifier)
- [3] *Service Location Protocol (SLP)*  
[http://en.wikipedia.org/wiki/Service\\_Location\\_Protocol](http://en.wikipedia.org/wiki/Service_Location_Protocol)
- [4] *JGroups*  
<http://www.jgroups.org/>
- [5] *UDDI*  
[http://en.wikipedia.org/wiki/Universal\\_Description\\_Discovery\\_and\\_Integration](http://en.wikipedia.org/wiki/Universal_Description_Discovery_and_Integration)
- [6] *Service Component Architecture (SCA)*  
<http://www.osa.org/display/Main/Home>

## 122.15      Changes

- Introduced Endpoint Event Listener.
- Deprecated Endpoint Listener.

- Added update to Import Registration and Export Registration.
- Added capability namespace definitions.
- Removed endpoint sharing.
- Removed text around setting of Framework UUID property (not needed for Core Frameworks version 4.3 or newer).
- Clarified the rules concerning Remote Service Endpoint identifier uniqueness.

# 123 JTA Transaction Services Specification

*Version 1.0*

## 123.1 Introduction

Transactions are the key abstraction to provide reliability with large scale distributed systems and are a primary component of enterprise systems. This specification provides an OSGi service based design for the Java Transaction Architecture (JTA) Specification, which describes the standard transaction model for Java applications. Providing the JTA specification as a service based model enables the use of independent implementations. This JTA Transaction Services Specification provides a managed model, where an Application Container (such as the Java EE EJB container) manages the transaction and the enlistment of resources, and an unmanaged model, where each application is responsible for these tasks itself.

This specification provides a brief overview of JTA and then the use of it through 3 transaction services: User Transaction, Transaction Manager, and Transaction Synchronization.

This specification is based on [1] *Java Transaction API Specification 1.1*.

### 123.1.1 Essentials

- *Portability* - It is important that applications are easy to port from other environments that support JTA.
- *Pluggability* - Allow different vendors to provide implementations of this specification.
- *JTA Compatible* - Support full JTA 1.1 Specification

### 123.1.2 Entities

- *JTA Provider* - Implementation of this specification. It is responsible, on request from a Transaction Originator, for starting and ending transactions and coordinating the work of Resource Managers that become involved in each Transaction. This entity provides the User Transaction service, Transaction Manager service, and the Transaction Synchronization Registry service.
- *Transaction* - An atomic unit of work that is associated with a thread of execution.
- *Transaction Originator* - An Application or its Container, that directs the JTA Provider to begin and end Transactions.
- *User Transaction* - A service used by a Transaction Originator for beginning and ending transactions.
- *Transaction Manager* - A service used by a Transaction Originator for managing both transaction demarcation and enlistment of Durable Resources or Volatile Resources.
- *Transaction Synchronization Registry* - A service for enlistment of Volatile Resources for getting notifications before and after ending Transactions.
- *Application Bundle* - An entity that initiates work that executes under a Transaction.
- *Container* - An entity that is distinct from the Application and which provides a managed environment for Applications. Unmanaged environments do not distinguish between the Application and Container entities.

- *Resource Manager* - Provides the transactional resources whose work is externally coordinated by a JTA Provider. Examples of Resource Managers include databases, Java Message Service providers and enterprise information systems.
- *Durable Resource* - A resource whose work is made durable when the Transaction is successfully committed. Durable Resources can be enlisted with a Transaction to ensure that work is performed within the scope of the Transaction and to participate in the outcome of a Transaction. Durable Resource enlistment is the responsibility of the Application Bundle or its Container. Durable Resources implement the `javax.transaction.xa.XAResource` interface
- *Volatile Resource* - Resources that are associated with a Transaction but are no longer needed after the Transaction, for example transaction-scoped caches. Volatile Resources are registered with the JTA Provider to receive notifications before and after the outcome of the Transaction. Volatile Resources implement the `javax.transaction.Synchronization` interface
- *Transaction Services* - The triplet of the User Transaction, Transaction Manager, and Transaction Synchronization Registry services registered by the JTA Provider.

Figure 123.1 Transaction Service Specification Entities

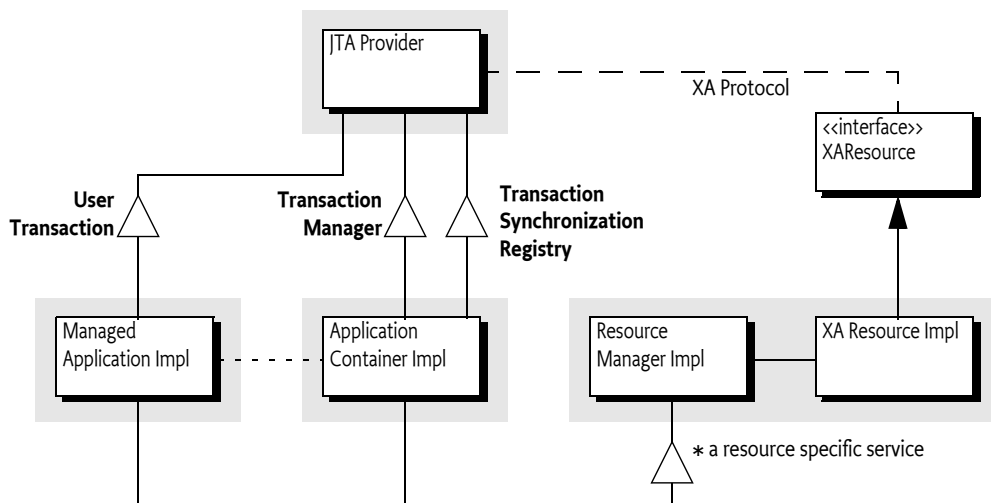

### 123.1.3 Dependencies

This specification is based on the following packages:

```

javax.transaction
javax.transaction.xa

```

These packages must be exported as version 1.1.

### 123.1.4 Synopsis

The JTA Provider register the Transaction Services:

- *User Transaction* - Offers transaction demarcation capabilities to an Application bundle.
- *Transaction Manager* - Offers transaction demarcation and further transaction management capabilities to an Application Bundle or an Application Container.
- *Transaction Synchronization Registry* - Offers a callback registration service for volatile transactional participants wishing to be notified of the completion of the transaction.

A JTA Provider must register these services when it is started. A JTA Provider may put restrictions on which bundles can use these services. For example, in a Java EE environment, the JTA Provider does not expose the `TransactionManager` interface to applications. An OSGi environment which

supports the Java EE specifications will typically provide access to the Transaction Manager service only to Java EE Containers.

A typical example of the use of a transaction is for transferring money from one bank account to another. Two Durable Resources are involved, one provided by the database from which the money is to be withdrawn and another provided by the database to which the money will be deposited. An Application Bundle acting as the Transaction Originator gets the User Transaction service and uses it to begin a transaction. This transaction is associated with the current thread (implicitly) by the JTA Provider. On the same thread of execution, the Application Bundle connects to the database from which the money is to be withdrawn and updates the balance in the source account by the amount to be debited.

The database is a resource manager whose connections have associated XA Resources; the first time a connection is used within the scope of a new transaction the Application Bundle, or a Container, obtains the XA Resource associated with the connection and enlists it with the JTA Provider through the Transaction Manager service. On the same thread of execution, the Application Bundle connects to the second database and updates the balance in the target account by the amount to be credited. An XA Resource for the second connection is enlisted with the Transaction Manager service as well by the Application Bundle or a Container.

Now that the money has been transferred the Transaction Originator requests a commit of the Transaction (on the same thread of execution) via the User Transaction Service, causing the JTA Provider to initiate the two-phase commit process with the two Resource Managers through the enlisted XA Resources. The transaction is then atomically committed or rolled back.

## 123.2 JTA Overview

A transaction is a unit of work in which interactions with multiple participants can be coordinated by a third party such that the final outcome of these interactions has well-defined transactional semantics. A variety of well-known transaction models exist with specific characteristics; the transactions described in this specification provide *Atomic Consistent Isolated and Durable* (ACID) semantics as defined in [2] *XA+ Specification* whereby all the participants in a transaction are coordinated to an *atomic* outcome in which the work of all the participants is either completely committed or completely rolled back.

The [2] *XA+ Specification* defines a *Distributed Transaction Processing* (DTP) software architecture for transactional work that is distributed across multiple Resource Managers and coordinated externally by a Transaction Manager using the two-phase commit XA protocol. The DTP architecture defines the roles of the *Transaction Manager* and *Resource Manager*; this specification uses the term *JTA Provider* rather than *Transaction Manager* to distinguish it from the *Transaction Manager service*. Note that Distributed Transaction Processing does not imply distribution of transactions across multiple frameworks or JVMs.

The [1] *Java Transaction API Specification 1.1* defines the Java interfaces required for the management of transactions on the enterprise Java platform.

### 123.2.1 Global and Local Transactions

A transaction may be a *local transaction* or a *global transaction*. A local transaction is a unit of work that is local to a single Resource Manager and may succeed or fail independently of the work of other Resource Managers. A global transaction, sometimes referred to as a distributed transaction, is a unit of work that may encompass multiple Resource Managers and is coordinated by a JTA Provider external to the Resource Manager(s) as described in the DTP architecture. The term *transaction* in this specification always refers to a global transaction.

The JTA Provider is responsible for servicing requests from a Transaction Originator to create and complete transactions, it manages the state of each transaction it creates, the association of each

transaction with the thread of execution, and the coordination of any Resource Managers that become involved in the global transaction. The JTA Provider ensures that each transaction is associated with, at most, one application thread at a time and provides the means to move that association from one thread to another as needed.

The model for resource commit coordination is the *two phase commit* XA protocol, with Resource Managers being directed by the JTA Provider. The first time an Application accesses a Resource Manager within the scope of a new global transaction, the Application, or its Container, obtains an XA Resource from the Resource Manager and *enlists* this XA Resource with the JTA Provider.

At the end of a transaction, the Transaction Originator must decide whether to initiate a *commit* or *rollback* request for all the changes made within the scope of the Transaction. The Transaction Originator requests that the JTA Provider completes the transaction. The JTA Provider then negotiates with each enlisted Resource Manager to reach a coordinated outcome. A failure in the transaction at any point before the second phase of two-phase commit results in the transaction being rolled back.

XA is a *presumed abort* protocol and implementations of XA-compliant JTA Providers and Resource Managers can be highly optimized to perform no logging of transactional state until a commit decision is required. A Resource Manager durably records its prepare decision, and a JTA Provider durably records any commit decision it makes. Failures between a decision on the outcome of a transaction and the enactment of that outcome are handled during *transaction recovery* to ensure the atomic outcome of the transaction.

### 123.2.2 Durable Resource

Durable Resources are provided by Resource Managers and must implement the XAResource interface described in the [1] *Java Transaction API Specification 1.1*. An XAResource object is enlisted with a transaction to ensure that the work of the Resource Manager is associated with the correct transaction and to participate in the two-phase commit process. The XAResource interface is driven by the JTA Provider during the completion of the transaction and is used to direct the Resource Manager to commit or rollback any changes made under the corresponding transaction.

### 123.2.3 Volatile Resource

Volatile resources are components that do not participate in the two phase commit but are called immediately prior to and after the two phase commit. They implement the [1] *Java Transaction API Specification 1.1* Synchronization interface. If a request is made to commit a transaction then the volatile participants have the opportunity to perform some *before completion* processing such as flushing cached updates to persistent storage. Failures during the *before completion* processing must cause the transaction to rollback. In both the commit and rollback cases the volatile resources are called after two phase commit to perform *after completion* processing. *After completion* processing cannot affect the outcome of the transaction.

### 123.2.4 Threading

As noted above in *Global and Local Transactions* on page 793, a global transaction must not be associated with more than one application thread at a time but can be moved over time from one application thread to another. In some environments Applications run in containers which restrict the ability of the Application component to explicitly manage the transaction-thread association by restricting access to the Transaction Manager. For example, Java EE application servers provide web and EJB Containers for application components and, while the Containers themselves can explicitly manage transaction-thread associations, these containers do not allow the Applications to do so. Applications running in these containers are required to complete any transactions they start on that same application thread. In general, Applications that run inside a Container must follow the rules defined by that Container. For further details of the considerations specific to Java EE containers, see the section *Transactions and Threads* in [4] *Java Platform, Enterprise Edition (Java EE) Specification, v5*.

## 123.3 Application

An *Application* is a bundle that may use transactions, either as a Transaction Originator or as a bundle that is called as part of an existing transaction. A Transaction Originator Application bundle starts a transaction and end it with a commit or rollback using the User Transaction or Transaction Manager service.

A Transaction Originator Application bundle may not make use of Resource Managers itself but may simply provide transaction demarcation and then call other bundles which do use Resource Managers. In such a case the Transaction Originator Application bundle requires only the use of the User Transaction service for transaction demarcation. The called bundles may use the Transaction Manager service if they use Resource Managers.

Application Bundles that use Resource Managers have to know the enlistment strategy for the Resource Managers they use. There are two possibilities:

- *Application Bundle Enlistment* - The Application Bundle must enlist the Resource Managers itself. For each Resource Manager it uses it must enlist that Resource Manager with the Transaction Manager.
- *Container-Managed Enlistment* - An Application runs in a container, such as a Java EE Container, which manages the Resource Manager enlistment on behalf of the Application.

These scenarios are explained in the following sections.

### 123.3.1 No Enlistment

A Transaction Originator Application bundle that uses no Resource Managers itself but starts a Transaction before calling another bundle may use the *User Transaction* service to control the Transaction demarcation.

For example, an Application can use the User Transaction service to begin a global transaction:

```
UserTransaction ut = getUserTransaction();
ut.begin();
```

The User Transaction service associates a transaction with the current thread until that transaction is completed via:

```
UserTransaction ut = getUserTransaction();
ut.commit();
```

Or the equivalent rollback method. The `getUserTransaction` method implementation (not shown) can get the User Transaction service directly from the service registry or from an injected field.

### 123.3.2 Application Bundle Enlistment

An Application Bundle is responsible for enlisting Resource Managers itself. That is, it must enlist Resource Manager it uses with the *Transaction Manager* service. The Transaction Manager service is an implementation of the JTA `TransactionManager` interface, registered by the JTA Provider.

For example, an Application Bundle can get an `XADataSource` object from a Data Source Factory service. Such a Data Source object can provide an `XAConnection` object that then can provide an `XAResource` object. `XAResource` objects can then be enlisted with the Transaction Manager service.

For example:

```
TransactionManager tm;
XADataSource      left;
```

```

XADataSource      right;

void acid() throws Exception {
    tm.begin();
    Transaction transaction = tm.getTransaction();
    try {
        XAConnection left = this.left.getXAConnection();
        XAConnection right = this.right.getXAConnection();
        transaction.enlistResource( left.getXAResource());
        transaction.enlistResource( right.getXAResource());
        doWork(left.getConnection(), right.getConnection());
        tm.commit();
    } catch( Throwable t ) {
        tm.rollback();
        throw t; } }

// ...
void setTransactionManager( TransactionManager tm ) { this.tm= tm; }
void setDataSourceFactory( DataSourceFactory dsf ) {
    left = dsf.createXADataSource( getLeftProperties() );
    right = dsf.createXADataSource( getRightProperties() );
}

```

In the previous example, the Transaction Manager service could have been injected with a component model like Declarative Services:

```

<reference interface="javax.transaction.TransactionManager"
    bind="setTransactionManager"/>
<reference name="dsf" interface="org.osgi.service.jdbc.DataSourceFactory"
    bind="setDataSourceFactory"/>

```

For example, it is possible to provide a Data Source service that provides automatic enlistment of the Connection as an XA Resource when one of its getConnection methods is called inside a transaction. The following code contains a Declarative Service component that implement this design. The component references a Transaction Manager service and a Data Source Factory service and provides a Data Source service that proxies an XA Data Source. Applications depend on the Data Source service, assuming that the Data Source service automatically enlists the connections it uses inside a transaction. See for an overview Figure 123.2 on page 796.

Figure 123.2 Data Source Proxy

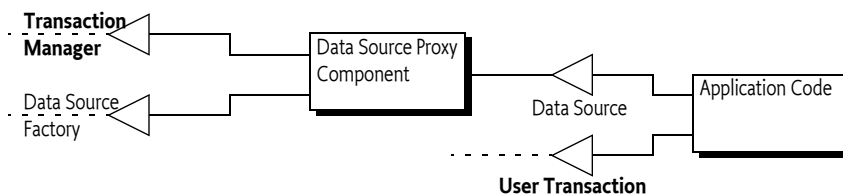

This general purpose Data Source Proxy component can be fully configured by the Configuration Admin service to instantiate this component for each needed database connection. The Declarative Services service properties can be used to select a Data Source Factory for the required database driver (using the target), as well as provide the configuration properties for the creation of an XA Data Source. That is, such a component could be part of a support library.

The code for such an Application component could start like:



```
public class DataSourceProxy implements DataSource{
    Properties          properties = new Properties();
    TransactionManager tm;
    XADataSource        xads;
```

The activate method is called when the component's dependencies are met, that is, there is a Transaction Manager service as well as a matching Data Source Factory service. In this method, the properties of the component are copied to a Properties object to be compatible with the Data Source Factory methods.

```
void activate(ComponentContext c) {
    // copy the properties set by the Config Admin into properties
    ...
}
```

The relevant methods in the Data Source Proxy component are the getConnection methods. The contract for this proxy component is that it enlists the XA Data Connection's XA Resource when it is called inside a transaction. This enlistment is done in the private enlist method.

```
public Connection getConnection() throws SQLException{
    XAConnection connection = xads.getXAConnection();
    return enlist(connection); }

public Connection getConnection(String username, String password)
    throws SQLException {
    XAConnection connection = xads.getXAConnection(username,password);
    return enlist(connection); }
```

The enlist method checks if there currently is a transaction active. If not, it ignores the enlistment, the connection will then not be connection to the transaction. If there is a current transaction, it enlists the corresponding XA Resource.

```
private Connection enlist(XAConnection connection) throws SQLException {
    try {
        Transaction transaction = tm.getTransaction();
        if (transaction != null)
            transaction.enlistResource( connection.getXAResource());
    } catch (Exception e) {
        SQLException sqle=
            new SQLException("Failed to enlist");
        sqle.initCause(e);
        throw sqle;
    }
    return connection.getConnection();
}
```

What remains are a number of boilerplate methods that forward to the XA Data Source or set the dependencies.

```
void setTransactionManager(TransactionManagertm) { this.tm = tm;}
void setDataSourceFactory(DataSourceFactory dsf) throws Exception{
    xads = dsf.createXADataSource(properties);}
public PrintWriter getLogWriter()
    throws SQLException { return xads.getLogWriter(); }

public int getLoginTimeout()
```

```
        throws SQLException { return xads.getLoginTimeout();}

public void setLogWriter(PrintWriter out)
    throws SQLException { xads.setLogWriter(out); }

public void setLoginTimeout(int seconds)
    throws SQLException { xads.setLoginTimeout(seconds);}
```

This is a fully coded example, it only lacks the configuration definitions for the Configuration Admin service.

This example Data Source proxy component makes it possible for an Application to depend on a Data Source service. The connections the Application uses from this Data Source are automatically transactional as long as there is a current transaction when the service is called. However, this approach only works when all bundles in the OSGi framework follow the same enlistment strategy because this specification does not provide a common enlistment strategy.

### 123.3.3 Container Managed Enlistment

The Application Container is responsible for enlisting Resource Managers used by the Application. For example, the Java EE Web and EJB Containers have a well defined model for managing resources within a transaction. If an Application runs inside a Java EE Container then it is the responsibility of the Java EE Container to handle the resource enlistment, the actual rules are beyond this specification.

A Transaction Originator Application bundle running inside a Container which manages any Resource Managers enlistment may use the User Transaction service for transaction demarcation, assuming this service is made available by the Container.

When a Java EE Container runs inside an OSGi framework then it must ensure that any services seen by its contained Applications are the same Transaction services as other bundles on that OSGi framework.

## 123.4 Resource Managers

Resource Managers perform work that needs to be committed or rolled back in a transaction. To participate in a transaction, a Resource Manager must have an XA Resource enlisted with the current transaction. This specification does not define how OSGi service implementations should be enlisted. This can be done by a Java EE Container, the Applications themselves, or through some other unspecified means.

## 123.5 The JTA Provider

The JTA Provider is the entity that provides the transaction services:

- *User Transaction* - A service that implements the JTA `UserTransaction` interface.
- *Transaction Manager* - A service that implements the JTA `TransactionManager` interface.
- *Transaction Synchronization Registry* - A service that implements the JTA `TransactionSynchronizationRegistry` interface.

There can be at most one JTA Provider in an OSGi framework and this JTA Provider must ensure that at most one transaction is associated with an application thread at any moment in time. All JTA Provider's transaction services must map to the same underlying JTA implementation. All JTA services should only be registered once.

### 123.5.1 User Transaction

The User Transaction service may be used by an Application bundle, acting as the Transaction Originator, to demarcate transaction boundaries when the bundle has no need to perform resource enlistment.

### 123.5.2 Transaction Manager

The Transaction Manager service offers transaction demarcation and further transaction management capabilities, such as Durable and Volatile resource enlistment, to an Application bundle or Application Container.

### 123.5.3 Transaction Synchronization Service

The Transaction Synchronization Registry service may be used by an Application bundle or a Container. The service provides for the registration of Volatile Resources that implement the JTA Synchronization interface.

For example:

```
private class MyVolatile implements Synchronization{...}
TransactionSynchronizationRegistry tsr = ...; // may be injected
tsr.registerInterposedSynchronization(new MyVolatile());
```

## 123.6 Life Cycle

### 123.6.1 JTA Provider

The life cycle of the transaction services and bundles that make up the JTA Provider must be dealt with appropriately such that implementations always ensure the atomic nature of transactions. When the JTA Provider is stopped and its services are unregistered, the JTA Provider must make sure that all active transactions are dealt with appropriately. A JTA Provider can decide to rollback all active transactions or it can decide to keep track of existing active transactions and allow them to continue to their normal conclusion but not allow any new transactions to be created. Any failures caused by executing code outside their life cycle can be dealt with as general failures. From a transactional consistency point of view, stopping the bundle(s) that implement the JTA Provider while transactional work is in-flight, is no different from a failure of the framework hosting the JTA Provider. In either case transaction recovery is initiated by the JTA Provider after it has re-started.

There are well-defined XA semantics between a JTA Provider and Resource Managers in the event of a failure of either at any point in a transaction. If a Resource Manager bundle is stopped while it is involved in-flight transactions then the JTA Provider should exhibit the same external behavior it does in the event of a communication failure with the Resource Manager. For example a JTA Provider will respond to an XAER\_RMFAIL response resulting from calling the XAResource commit method by retrying the commit. The mechanism used by the JTA Provider to determine when to retry the commit is a detail of the implementation.

### 123.6.2 Application Bundles

Applications can act in the role of the Transaction Originator. There is no guarantee that an Application that starts a transaction will always be available to complete the transaction since the client can fail independently of the JTA Provider. A failure of the Application Bundle to complete, in a timely fashion, a transaction it originated must finally result in the JTA Provider rolling back the transaction.

### 123.6.3 Error Handling

This specification does not define a specific error handling strategy. Exceptions and errors that occur during transaction processing can result in the transaction being marked *rollback-only* by the container or framework in which an Application runs or may be left for the Application to handle. An Application which receives an error or an exception while running under a transaction can choose to mark the transaction rollback-only.

## 123.7 Security

This specification relies on the security model of JTA.

## 123.8 References

- [1] *Java Transaction API Specification 1.1*  
<http://www.oracle.com/technetwork/java/javaee/jta/index.html>
- [2] *XA+ Specification*  
Version 2, The Open Group, ISBN: 1-85912-046-6
- [3] *Transaction Processing*  
J. Gray and A. Reuter. Morgan Kaufmann Publishers, ISBN 1.55860-190-2
- [4] *Java Platform, Enterprise Edition (Java EE) Specification, v5*  
<http://jcp.org/en/jsr/detail?id=244>

# 125 JDBC™ Service Specification

Version 1.0

## 125.1 Introduction

The Java Database Connectivity (JDBC) standard provides an API for applications to interact with relational database systems from different vendors. To abstract over concrete database systems and vendor specific characteristics, the JDBC specification provides various classes and Service Provider Interfaces (SPI) that can be used for database interaction. Implementations are database specific and provided by the corresponding driver. This specification defines how OSGi-aware JDBC drivers can provide access to their implementations. Applications can rely on this mechanism to transparently access drivers and to stay independent from driver specific classes. Additionally, this mechanism helps to use common OSGi practices and to avoid class loading problems.

This specification uses a number of packages that are defined in Java SE 1.4 or later.

### 125.1.1 Essentials

- *Registration* - Provide a mechanism for JDBC driver announcements.
- *Lookup* - Inspect available database drivers and provide means for driver access.
- *Services* - Uses a service model for getting the driver objects.
- *Compatible* - Minimize the amount of work needed to support this specification for existing drivers.

### 125.1.2 Entities

- *Relational Database Management Systems* - (RDBMS) An external database system.
- *Database Driver* - JDBC-compliant database driver that is delivered in a bundle.
- *Data Source Factory* - Provides one of the different Data Sources that gives access to a database driver.
- *Application* - The application that wants to access a relational database system.

Figure 125.1 JDBC Class/Service Overview

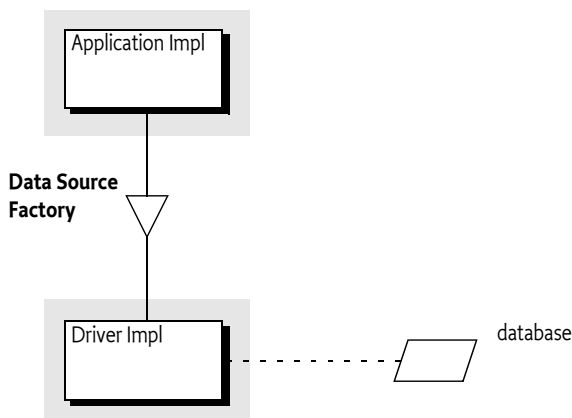

### 125.1.3 Dependencies

The classes and interfaces used in this specification come from the following packages:

```
javax.sql  
java.sql
```

These packages have no associated version. It is assumed they come from the runtime environment. This specification is based on Java SE 1.4 or later.

### 125.1.4 Synopsis

A JDBC *Database Driver* is the software that maps the JDBC specification to a specific implementation of a relational database. For OSGi, JDBC drivers are delivered as driver bundles. A driver bundle registers a Data Source Factory service when it is ACTIVE. Service properties are used to specify the database driver name, version, etc. The Data Source Factory service provides methods to create DataSource, ConnectionPoolDataSource, XADataSource, or Driver objects. These objects are then used by an application to interact with the relational database system in the standard way.

The application can query the service registry for available Data Source Factory services. It can select particular drivers by filtering on the service properties. This service based model is easy to use with dependency injection frameworks like Blueprint or Declarative Services.

## 125.2 Database Driver

A Database Driver provides the connection between an *Application* and a particular database. A single OSGi Framework can contain several Database Drivers simultaneously. To make itself available to Applications, a Database Driver must register a Data Source Factory service. Applications must be able to find the appropriate Database Driver. The Database Driver must therefore register the Data Source Factory service with the following service properties:

- [OSGI\\_JDBC\\_DRIVER\\_CLASS](#) - (String) The required name of the driver implementation class. This property is the primary key to find a driver's Data Source Factory. It is not required that there is an actual class with this name.
- [OSGI\\_JDBC\\_DRIVER\\_NAME](#) - (String) The optional driver name. This property is informational.
- [OSGI\\_JDBC\\_DRIVER\\_VERSION](#) - (String) The driver version. The version is not required to be an OSGi version, it should be treated as an opaque string. This version is likely not related to the package of the implementation class or its bundle.

The previous properties are vendor-specific and are meant to further describe the Database Driver to the Application.

Each Data Source Factory service must relate to a single Database Driver. The Database Driver implementation bundle does not necessarily need to be the registrar of the Data Source Factory service. Any bundle can provide the Data Source Factory service and delegate to the appropriate driver specific implementation classes. However, as JDBC driver implementations evolve to include built-in support for OSGi they can provide the Data Source Factory service themselves. This implies that the same driver can be registered multiple times.

### 125.2.1 Life Cycle

A Data Source Factory service should be registered while its Driver Bundle is in the ACTIVE state or when it has a lazy activation policy and is in the STARTING state.

What happens to the objects created by the Data Source Factory service, and the objects they created, is undefined in this specification. Database Drivers are not mandated to track the proper life cycle of these objects.

### 125.2.2 Package Dependencies

A Database Driver must import the `javax.sql` package. The `java.sql` package that contains the `Driver` and `SQLException` interface is automatically imported because it starts with `java..` Both packages are contained in the JRE since Java SE 1.4. These packages are not normally versioned with OSGi version numbers. Bundles using the Data Source Factory must therefore ensure they get the proper imports, which is usually from the JRE. Due to the lack of specified metadata, the deployer is responsible for ensuring this.

## 125.3 Applications

### 125.3.1 Selecting the Data Source Factory Service

Applications can query the OSGi service registry for available Database Drivers by getting a list of Data Source Factory services. Normally, the application needs access to specific drivers that match their needed relational database type. The service properties can be used to find the desired Database Driver. This model is well supported by dependency injection frameworks like Blueprint or Declarative Services. However, it can of course also be used with the basic service methods. The following code shows how a Service Tracker can be used to get a Database Driver called ACME DB.

```
Filter filter = context.createFilter(
    "&(objectClass=" +
        DataSourceFactory.class.getName() +
    ") (" +
        DataSourceFactory.OSGI_JDBC_DRIVER_CLASS + "=com.acme.db.Driver)");
```

```
ServiceTracker tracker = new ServiceTracker(context, filter, null);
tracker.open();
```

```
DataSourceFactory dsf = (DataSourceFactory) tracker.getService();
```

### 125.3.2 Using Database Drivers

The Data Source Factory service can be used to obtain instances for the following JDBC related types:

- `javax.sql.DataSource`
- `javax.sql.ConnectionPoolDataSource`
- `javax.sql.XADataSource`
- `java.sql.Driver`

Which type of Connection provider that is actually required depends on the Application and the use case. For each type, the Data Source Factory service provides a method that returns the corresponding instance. Each method takes a `Properties` object as a parameter to pass a configuration to the Database Driver implementation. The configuration is driver-specific and can be used to specify the URL for the database and user credentials. Common property names for these configuration properties are also defined in the `DataSourceFactory` interface.

A Data Source Factory is not required to implement all of the factory methods. If an implementation does not support a particular type then it must throw a `SQLException`. This specification does not provide a mechanism to depend on a Data Source Factory service that implements a particular factory method.

The following code shows how a `DataSource` object could be created.

```
Properties props = new Properties();
```

```
props.put(DataSourceFactory.JDBC_URL, "jdbc:acme:ACMEDB");
props.put(DataSourceFactory.JDBC_USER, "foo");
props.put(DataSourceFactory.JDBC_PASSWORD, "secret");
DataSource dataSource = dsf.createDataSource(props);
```

The DataSourceFactory interface has several static fields that represent common property keys for the Properties instance. General properties are:

- [JDBC\\_DATABASE\\_NAME](#)
- [JDBC\\_DATASOURCE\\_NAME](#)
- [JDBC\\_DESCRIPTION](#)
- [JDBC\\_NETWORK\\_PROTOCOL](#)
- [JDBC\\_PASSWORD](#)
- [JDBC\\_PORT\\_NUMBER](#)
- [JDBC\\_ROLE\\_NAME](#)
- [JDBC\\_SERVER\\_NAME](#)
- [JDBC\\_USER](#)
- [JDBC\\_URL](#)

The following additional property keys are provided for applications that want to create a ConnectionPoolDataSource object or a XAPoolDataSource object:

- [JDBC\\_INITIAL\\_POOL\\_SIZE](#)
- [JDBC\\_MAX\\_IDLE\\_TIME](#)
- [JDBC\\_MAX\\_POOL\\_SIZE](#)
- [JDBC\\_MAX\\_STATEMENTS](#)
- [JDBC\\_MIN\\_POOL\\_SIZE](#)
- [JDBC\\_PROPERTY\\_CYCLE](#)

Which property keys and values are supported depends on the driver implementation. Drivers can support additional custom configuration properties.

### 125.3.3 Using JDBC in OSGi and Containers

The JDBC service provides JDBC driver services, not *container* services. A typical client would only use the DataSourceFactory.createDataSource() method to procure a regular Data Source from which they can obtain (usually non-pooled) connections.

Containers generally offer connection pools and support XA transactions. The container manages the pools and does this by using Pooled Connection or XA Connection objects from a driver-implemented respective Connection Pool Data Source or XA Data Source. To support containers, frameworks, or any client that wants to manage a pool, these Data Source types are included in the Data Source Factory service. Drivers are permitted to implement their own Data Source using an underlying connection pooling scheme. This is driver-dependent and not related to the OSGi specifications.

The usual set of JDBC properties are defined in the services for use with the Data Source types. They are the same as what is defined for JDBC and the caller should know which properties make sense when passed to a given Data Source type. The same result should occur in OSGi as occurs outside of OSGi. If the driver does not support a given property with a given Data Source type then it can ignore it or it can throw an Exception.

## 125.4 Security

This specification depends on the JDBC specification for security.



## 125.5 org.osgi.service.jdbc

JDBC Service Package Version 1.0.

Bundles wishing to use this package must list the package in the Import-Package header of the bundle's manifest. This package has two types of users: the consumers that use the API in this package and the providers that implement the API in this package.

Example import for consumers using the API in this package:

```
Import-Package: org.osgi.service.jdbc; version="[1.0,2.0)"
```

Example import for providers implementing the API in this package:

```
Import-Package: org.osgi.service.jdbc; version="[1.0,1.1)"
```

### 125.5.1 Summary

- `DataSourceFactory` - A factory for JDBC connection factories.

### 125.5.2 public interface DataSourceFactory

A factory for JDBC connection factories. There are 3 preferred connection factories for getting JDBC connections: `javax.sql.DataSource`, `javax.sql.ConnectionPoolDataSource`, and `javax.sql.XADataSource`. `DataSource` providers should implement this interface and register it as an OSGi service with the JDBC driver class name in the OSGI `JDBC_DRIVER_CLASS` property.

*Concurrency* Thread-safe

#### 125.5.2.1 public static final String JDBC\_DATABASE\_NAME = "databaseName"

The "databaseName" property that `DataSource` clients should supply a value for when calling `createDataSource(Properties)`.

#### 125.5.2.2 public static final String JDBC\_DATASOURCE\_NAME = "dataSourceName"

The "dataSourceName" property that `DataSource` clients should supply a value for when calling `createDataSource(Properties)`.

#### 125.5.2.3 public static final String JDBC\_DESCRIPTION = "description"

The "description" property that `DataSource` clients should supply a value for when calling `createDataSource(Properties)`.

#### 125.5.2.4 public static final String JDBC\_INITIAL\_POOL\_SIZE = "initialPoolSize"

The "initialPoolSize" property that `ConnectionPoolDataSource` and `XADataSource` clients may supply a value for when calling `createConnectionPoolDataSource(Properties)` or `createXADataSource(Properties)` on drivers that support this property.

#### 125.5.2.5 public static final String JDBC\_MAX\_IDLE\_TIME = "maxIdleTime"

The "maxIdleTime" property that `ConnectionPoolDataSource` and `XADataSource` clients may supply a value for when calling `createConnectionPoolDataSource(Properties)` or `createXADataSource(Properties)` on drivers that support this property.

#### 125.5.2.6 public static final String JDBC\_MAX\_POOL\_SIZE = "maxPoolSize"

The "maxPoolSize" property that `ConnectionPoolDataSource` and `XADataSource` clients may supply a value for when calling `createConnectionPoolDataSource(Properties)` or `createXADataSource(Properties)` on drivers that support this property.

- 125.5.2.7**      **public static final String JDBC\_MAX\_STATEMENTS = "maxStatements"**  
The "maxStatements" property that ConnectionPoolDataSource and XADataSource clients may supply a value for when calling createConnectionPoolDataSource(Properties) or createXADataSource(Properties) on drivers that support this property.
- 125.5.2.8**      **public static final String JDBC\_MIN\_POOL\_SIZE = "minPoolSize"**  
The "minPoolSize" property that ConnectionPoolDataSource and XADataSource clients may supply a value for when calling createConnectionPoolDataSource(Properties) or createXADataSource(Properties) on drivers that support this property.
- 125.5.2.9**      **public static final String JDBC\_NETWORK\_PROTOCOL = "networkProtocol"**  
The "networkProtocol" property that DataSource clients should supply a value for when calling createDataSource(Properties).
- 125.5.2.10**     **public static final String JDBC\_PASSWORD = "password"**  
The "password" property that DataSource clients should supply a value for when calling createDataSource(Properties).
- 125.5.2.11**     **public static final String JDBC\_PORT\_NUMBER = "portNumber"**  
The "portNumber" property that DataSource clients should supply a value for when calling createDataSource(Properties).
- 125.5.2.12**     **public static final String JDBC\_PROPERTY\_CYCLE = "propertyCycle"**  
The "propertyCycle" property that ConnectionPoolDataSource and XADataSource clients may supply a value for when calling createConnectionPoolDataSource(Properties) or createXADataSource(Properties) on drivers that support this property.
- 125.5.2.13**     **public static final String JDBC\_ROLE\_NAME = "roleName"**  
The "roleName" property that DataSource clients should supply a value for when calling createDataSource(Properties).
- 125.5.2.14**     **public static final String JDBC\_SERVER\_NAME = "serverName"**  
The "serverName" property that DataSource clients should supply a value for when calling createDataSource(Properties).
- 125.5.2.15**     **public static final String JDBC\_URL = "url"**  
The "url" property that DataSource clients should supply a value for when calling createDataSource(Properties).
- 125.5.2.16**     **public static final String JDBC\_USER = "user"**  
The "user" property that DataSource clients should supply a value for when calling createDataSource(Properties).
- 125.5.2.17**     **public static final String OSGI\_JDBC\_DRIVER\_CLASS = "osgi.jdbc.driver.class"**  
Service property used by a JDBC driver to declare the driver class when registering a JDBC DataSourceFactory service. Clients may filter or test this property to determine if the driver is suitable, or the desired one.
- 125.5.2.18**     **public static final String OSGI\_JDBC\_DRIVER\_NAME = "osgi.jdbc.driver.name"**  
Service property used by a JDBC driver to declare the driver name when registering a JDBC DataSourceFactory service. Clients may filter or test this property to determine if the driver is suitable, or the desired one.

**125.5.2.19**      **public static final String OSGI\_JDBC\_DRIVER\_VERSION = "osgi.jdbc.driver.version"**

Service property used by a JDBC driver to declare the driver version when registering a JDBC DataSourceFactory service. Clients may filter or test this property to determine if the driver is suitable, or the desired one.

**125.5.2.20**      **public ConnectionPoolDataSource createConnectionPoolDataSource(Properties props) throws SQLException**

*props* The properties used to configure the ConnectionPoolDataSource. null indicates no properties. If the property cannot be set on the ConnectionPoolDataSource being created then a SQLException must be thrown.

- Create a new ConnectionPoolDataSource using the given properties.

*Returns* A configured ConnectionPoolDataSource.

*Throws* SQLException— If the ConnectionPoolDataSource cannot be created.

**125.5.2.21**      **public DataSource createDataSource(Properties props) throws SQLException**

*props* The properties used to configure the DataSource. null indicates no properties. If the property cannot be set on the DataSource being created then a SQLException must be thrown.

- Create a new DataSource using the given properties.

*Returns* A configured DataSource.

*Throws* SQLException— If the DataSource cannot be created.

**125.5.2.22**      **public Driver createDriver(Properties props) throws SQLException**

*props* The properties used to configure the Driver. null indicates no properties. If the property cannot be set on the Driver being created then a SQLException must be thrown.

- Create a new Driver using the given properties.

*Returns* A configured Driver.

*Throws* SQLException— If the Driver cannot be created.

**125.5.2.23**      **public XADataSource createXADataSource(Properties props) throws SQLException**

*props* The properties used to configure the XADataSource. null indicates no properties. If the property cannot be set on the XADataSource being created then a SQLException must be thrown.

- Create a new XADataSource using the given properties.

*Returns* A configured XADataSource.

*Throws* SQLException— If the XADataSource cannot be created.

## 125.6      References

- [1] *Java SE 1.4*  
<http://www.oracle.com/technetwork/java/archive-139210.html>



# 126 JNDI Services Specification

## Version 1.0

### 126.1 Introduction

Naming and directory services have long been useful tools in the building of software systems. The ability to use a programming interface to publish and consume objects can provide many benefits to any system. The Java Naming and Directory Interface (JNDI) is a registry technology in Java applications, both in the Java SE and Java EE space. JNDI provides a vendor-neutral set of APIs that allow clients to interact with a naming service from different vendors.

The JNDI as used in the Java SE environment relies on the class loading model provided by the JDK to find providers. By default, it attempts to load the JNDI provider class using the Thread Context Class Loader. In an OSGi environment, this type of Context creation is not desirable since it relies on the JNDI provider classes being visible to the JNDI client, or require it to set the Context Class Loader; in both cases breaking modularity. For modularity reasons, it is important that clients are not required to express a dependency on the implementation of services they use.

This specification will define how JNDI can be utilized from within an OSGi framework. The specification consists of three key parts:

- *OSGi Service Model* - How clients interact with JNDI when running inside an OSGi Framework.
- *JNDI Provider Model* - How JNDI providers can advertise their existence so they are available to OSGi and traditional clients.
- *Traditional Model* - How traditional JNDI applications and providers can continue to work in an OSGi Framework without needing to be rewritten when certain precautions are taken.

#### 126.1.1 Essentials

- *Naming Service* - Provide an integration model for JNDI API clients and providers.
- *Flexible* - Provide a standard mechanism for publishing and locating JNDI providers.
- *Compatibility* - Support the traditional JNDI programming model used by Java SE and Java EE clients.
- *Service Based* - Provide a service model that clients and providers can use to leverage JNDI facilities.
- *Migration* - Provide a mechanism to access OSGi services from a JNDI context.

#### 126.1.2 Entities

- *JNDI Implementation* - The Implementer of the JNDI Context Manager, JNDI Provider Admin, and setter of the JNDI static singletons.
- *JNDI Client* - Any code running within an OSGi bundle that needs to use JNDI.
- *JNDI Context Manager* - A service that allows clients to obtain Contexts via a service.
- *JNDI Provider Admin* - A service that allows the conversion of objects for providers.
- *JNDI Provider* - Provides a Context implementation.
- *Context* - A Context abstracts a namespace. Implementations are provided by JNDI providers and the Contexts are used by JNDI clients. The corresponding interface is `javax.naming.Context`.

- *Dir Context* - A sub-type of Context that provides mechanisms for examining and updating the attributes of an object in a directory structure, and for performing searches in an hierarchical naming systems like LDAP. The corresponding interface is `javax.naming.directory.DirContext`.
- *Initial Context Factory* - A factory for creating instances of Context objects. This factory is used to integrate new JNDI Providers. In general, a single Initial Context Factory constructs Context objects for a single provider implementation. The corresponding interface is `javax.naming.spi.InitialContextFactory`.
- *Initial Context Factory Builder* - A factory for InitialContextFactory objects. A single Initial Context Factory Builder can construct InitialContextFactory objects for different types of Contexts. The interface is `javax.naming.spi.InitialContextFactoryBuilder`.
- *Object Factory* - Used in conversion of objects. The corresponding interface is `javax.naming.spi.ObjectFactory`.
- *Dir Object Factory* - An Object Factory that takes attribute information for object conversion. The corresponding interface is `javax.naming.spi.DirObjectFactory`.
- *Object Factory Builder* - A factory for ObjectFactory objects. A single Object Factory Builder can construct ObjectFactory instances for different types of conversions. The corresponding interface is `javax.naming.spi.ObjectFactoryBuilder`.
- *Reference* - A description of an object that can be turned into an object through an Object Factory. The associated Referenceable interface implemented on an object indicates that it can provide a Reference object.

Figure 126.1 JNDI Service Specification Service Entities

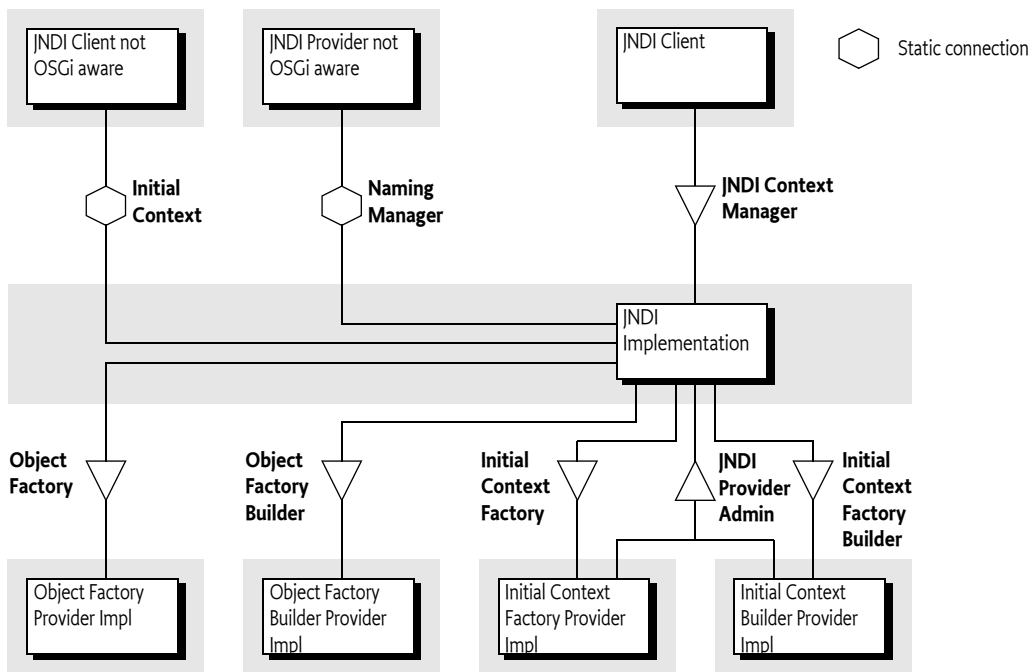

### 126.1.3 Dependencies

The classes and interfaces used in this specification come from the following packages:

```

javax.naming
javax.naming.spi
javax.naming.directory

```

These packages have no associated version. It is assumed they come from the runtime environment. This specification is based on Java SE 1.4 or later.

#### 126.1.4 Synopsis

A client bundle wishing to make use of JNDI in order to access JNDI Providers such as LDAP or DNS in OSGi should not use the Naming Manager but instead use the JNDI Context Manager service. This service can be asked for a Context based on environment properties. The environment properties are based on an optional argument in the `newInitialContext` method, the Java System properties, and an optional resource in the caller's bundle.

These environment properties can specify an implementation class name for a factory that can create a Context object. If such a class name is specified, then it is searched for in the service registry. If such a service is found, then that service is used to create a new Context, which is subsequently returned. If no class name is specified, the service registry is searched for Initial Context Factory services. These services are tried in ranking order to see if they can create an appropriate Context, the first one that can create a Context is then used.

If no class name is specified, all Initial Context Factory Builder services are tried to see if they can create a Context, the first non-null result is used. If no Context can be found, a `No Initial Context Exception` is thrown. Otherwise, the JNDI Context Manager service returns an initial Context that uses the just created Context from a provider as the backing service. This initial Context delegates all operations to this backing Context, except operations that use a name that can be interpreted as a URL, that is, the name contains a colon. URL operations are delegated a URL Context that is associated with the used scheme. URL Contexts are found through the general object conversion facility provided by the JNDI Provider Admin service.

The JNDI Provider Admin service provides a general object conversion facility that can be extended with Object Factory and Object Factory Builder services that are traditionally provided through the Naming Manager `getObjectInstance` method. A specific case for this conversion is the use of Reference objects. Reference objects can be used to store objects persistently in a Context implementation. Reference objects must be converted to their corresponding object when retrieved from a Context.

During the client's use of a Context it is possible that its provider's service is unregistered. In this case the JNDI Context Manager must release the backing Context. If the initial Context is used and no backing Context is available, the JNDI Context Manager must re-create a new Context, if possible. Otherwise a `NamingException` is thrown. If subsequently a proper new backing Context can be created, the initial Context must start operating again.

The JNDI Context Manager service must track the life cycle of a calling bundle and ensure that any returned Context objects are closed and returned objects are properly cleaned up when the bundle is closed or the JNDI Context Manager service is unget.

When the client bundle is stopped, any returned initial Context objects are closed and discarded. If the Initial Context Factory, or Initial Context Factory Builder, service that created the initial Context goes away then the JNDI Context Manager service releases the Context backing the initial Context and attempts to create a replacement Context.

Clients and JNDI Context providers that are unaware of OSGi use static methods to connect to the JRE JNDI implementation. The `InitialContext` class provides access to a Context from a provider and providers use the static `NamingManager` methods to do object conversion and find URL Contexts. This traditional model is not aware of OSGi and can therefore only be used reliably if the consequences of this lack of OSGi awareness are managed.

## 126.2 JNDI Overview

The Java Naming and Directory Interface (JNDI) provides an abstraction for namespaces that is included in Java SE. This section describes the basic concepts of JNDI as provided in Java SE. These concepts are later used in the service model provided by this specification.

### 126.2.1 Context and Dir Context

The [1] *Java Naming and Directory Interface* (JNDI) defines an API for *namespaces*. These namespaces are abstracted with the Context interface. Namespaces that support *attributes*, such as a namespace as the Lightweight Directory Access Protocol (LDAP), are represented by the DirContext class, which extends the Context class. If applicable, a Context object can be cast to a DirContext object. The distinction is not relevant for this specification, except in places where it is especially mentioned.

The Context interface models a set of name-to-object *bindings* within a namespace. These bindings can be looked-up, created, and updated through the Context interface. The Context interface can be used for federated, flat, or hierarchical namespaces.

### 126.2.2 Initial Context

Obtaining a Context for a specific namespace, for example DNS, is handled through the InitialContext class. Creating an instance of this class will cause the JRE to find a *backing* Context. The Initial Context is only a facade for the backing Context. The facade context provides URL based lookups.

The backing Context is created by a *JNDI Provider*. How this backing Context is created is an elaborate process using class loading techniques or a provisioning mechanism involving *builders*, see *Naming Manager Singletons* on page 813 for more information about the builder provisioning mechanism.

If there is no Initial Context Factory Builder set, the class name of a class implementing the InitialContextFactory interface is specified as a property in the *environment*. The environment is a Hashtable object that is constructed from different sources and then merged with System properties and a resource in the calling bundle, see *Environment* on page 813. In a standard Java SE JNDI, the given class name is then used to construct an InitialContextFactory object and this object is then used to create the backing Context. This process is depicted in Figure 126.2 on page 812.

Figure 126.2

Backing Context

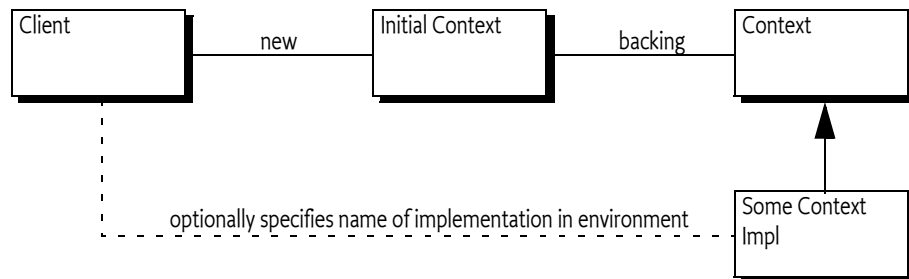

### 126.2.3 URL Context Factory

The InitialContext class implements the Context interface. It can therefore delegate all the Context interface methods to the backing Context object. However, it provides a special URL lookup behavior for names that are formed like URLs, that is, names that contain a colon (':' \u003A) character. This behavior is called a *URL lookup*.

URL lookups are not delegated to the backing Context but are instead first tried via a *URL Context* based lookup on the given scheme, like:



myscheme: foo

For example a lookup using `acme:foo/javax.sql.DataSource` results in a URL Context being used, rather than the backing Context.

JNDI uses class loading techniques to search for an `ObjectFactory` class that can be used to create this URL Context. The Naming Manager provides a static method `getURLContext` for this purpose. If such a URL Context is found, it is used with the requested operation and uses the full URL. If no such URL Context can be found, the backing Context is asked to perform the operation with the given name.

The URL lookup behavior is only done when the backing Context was created by the JNDI implementation in the JRE. If the backing Context had been created through the singleton provisioning mechanism, then no URL lookup is done for names that have a colon. The URL lookup responsibility is then left to the backing Context implementation.

#### 126.2.4 Object and Reference Conversion

The `NamingManager` class provides a way to create objects from a *description* with the `getObjectInstance` method. In general, it will iterate over a number of `ObjectFactory` objects and ask each one of them to provide the requested object. The first non-null result indicates success. These `ObjectFactory` objects are created from an environment property.

A special case for the description argument in the `getObjectInstance` method is the *Reference*. A Reference is a description of an object that can be stored persistently. It can be re-created into an actual object through the static `getObjectInstance` method of the `NamingManager` class. The Reference object describes the actual `ObjectFactory` implementing class that must be used to create the object.

This default behavior is completely replaced with the Object Factory Builder singleton by getting the to be used `ObjectFactory` object directly from the set singleton Object Factory Builder.

#### 126.2.5 Environment

JNDI clients need a way to set the configuration properties to select the proper JNDI Provider. For example, a JNDI Provider might require an identity and a password in order to access the service. This type of configuration is referred to as the *environment* of a Context. The environment is a set of properties. Common property names can be found in [3] *JNDI Standard Property Names*. The set of properties is build from the following sources (in priority order, that is later entries are shadowed by earlier entries):

1. Properties set in the environment Hashtable object given in the constructor argument (if any) of the `InitialContext` class.
2. Properties from the Java System Properties
3. Properties found in `$JAVA_HOME/lib/jndi.properties`

There are some special rules around the handling of specific properties.

#### 126.2.6 Naming Manager Singletons

The default behavior of the JRE implementation of JNDI can be extended in a standardized way. The `NamingManager` class has two static singletons that allow JNDI Providers outside the JRE to provide `InitialContextFactory` and `ObjectFactory` objects. These singletons are set with the following static methods on the `NamingManager` class:

- `setObjectFactoryBuilder(ObjectFactoryBuilder)` - A hook to provide `ObjectFactory` objects.
- `setInitialContextFactoryBuilder(InitialContextFactoryBuilder)` - A hook to provide `InitialContextFactory` objects. This hook is consulted to create a Context object that will be associated with an `InitialContext` object the client creates.

These JNDI Provider hooks are *singletons* and must be set *before* any application code creates an `InitialContext` object or any objects are converted. If these singletons are not set, the JNDI implementation in the JRE will provide a default behavior that is based on searching through classes defined in an environment property.

Both singletons can only be set once. A second attempt to set these singletons results in an `IllegalStateException` being thrown.

### 126.2.7 Built-In JNDI Providers

The Java Runtime Environment (JRE) defines the following default providers:

- *LDAP* - Lightweight Directory Access Protocol (LDAP) service provider
- *COS* - Corba Object Service (COS) naming service provider
- *RMI* - Remote Method Invocation (RMI) Registry service provider
- *DNS* - Domain Name System (DNS) service provider

Although these are the default JNDI Service Providers, the JNDI architecture provides a number of mechanisms to plug-in new types of providers.

## 126.3 JNDI Context Manager Service

The JNDI Context Manager service allows clients to obtain a Context using the OSGi service model. By obtaining a JNDI Context Manager service, a client can get a Context object so that it can interact with the available JNDI Providers. This service replaces the approach where the creation of a new `InitialContext` object provided the client with access to an `InitialContext` object that was backed by a JNDI Provider's Context.

The `JNDIContextManager` interface defines the following methods for obtaining Context objects:

- `newInitialContext()` - Obtain a Context object using the default environment properties.
- `newInitialContext(Map)` - Get a Context object using the default environment properties merged with the given properties.
- `newInitialDirContext()` - Get a `DirContext` object using a default environment properties.
- `newInitialDirContext(Map)` - Get a `DirContext` object using the default environment properties merged with the given properties.

The JNDI Context Manager service returns Context objects that implement the same behavior as the `InitialContext` class; the returned Context object does not actually extend the `InitialContext` class, its only guarantee is that it implements the Context interface.

This Context object is a facade for the context that is created by the JNDI Provider. This JNDI Provider's Context is called the *backing Context*. This is similar to the behavior of the `InitialContext` class. However, in this specification, the facade can change or loose the backing Context due to the dynamics of the OSGi framework.

The returned facade must also provides URL lookups, just like an Initial Context. However, the URL Context lookup must be based on Object Factory services with a service property that defines the scheme.

The environment properties used to create the backing Context are constructed in a similar way as the environment properties of the Java SE JNDI, see *Environment and Bundles* on page 815.

The following sections define in detail how a JNDI Provider Context must be created and managed.

### 126.3.1 Environment and Bundles

The Java SE JNDI looks for a file in `$(JAVAHOME)/lib/jndi.properties`, see *Environment* on page 813. A JNDI Implementation must not use this information but it must use a resource in the bundle that uses the JNDI Context Manager service. The order is therefore:

1. Properties set in the environment Hashtable object given in the constructor argument (if any) of the InitialContext class.
2. Properties from the Java System Properties
3. A properties resource from the bundle that uses the service called `/jndi.properties`.

The following four properties do not overwrite other properties but are merged:

- `java.naming.factory.object`
- `java.naming.factory.state`
- `java.naming.factory.control`
- `java.naming.factory.url.pkgs`

These property values are considered lists and the ultimate value used by the JNDI Providers is taken by merging the values found in each stage into a single colon separated list. For more information see [3] *JNDI Standard Property Names*.

The environment consists of the merged properties. This environment is then passed to the Initial Context Factory Builder for the creation of an Initial Context Factory.

### 126.3.2 Context Creation

When a client calls one of the `newInitialContext` (or `newInitialDirContext`) methods, the JNDI Context Manager service must construct an object that implements the Context interface based on the environment properties. All factory methods in the `InitialContextFactory` and `InitialContextFactoryBuilder` classes take a Hashtable object with the environment as an argument, see *Environment and Bundles* on page 815.

The caller normally provides a specific property in the environment that specifies the class name of a provider class. This property is named:

```
java.naming.factory.initial
```

The algorithm to find the provider of the requested Context can differ depending on the presence or absence of the `java.naming.factory.initial` property in the environment.

In the following sections the cases for presence or absence of the `java.naming.factory.initial` property are described. Several steps in these algorithm iterate over a set of available services. This iteration must always take place in service *ranking order*. Service ranking order follows the ordering of the `service.ranking` service property, which is the highest `service.ranking` value, or when equal, the lowest `service.id` value.

Exception handling in the following steps is as follows:

- If an Exception is thrown by an Initial Context Factory Builder service, then this Exception must be logged but further ignored.
- Exceptions thrown by the InitialContextFactory objects when creating a Context must be thrown to the caller.

#### 126.3.2.1 Implementation Class Present in Environment

If the implementation class is specified, a JNDI Provider is searched in the service registry with the following steps, which stop when a backing Context can be created:

1. Find a service in ranking order that has a name matching the given implementation class name as well as the `InitialContextFactory` class name. The searching must take place through the Bundle Context of the requesting bundle but must not require that the requesting bundle imports the package of the implementation class. If such a matching Initial Context Factory service is found, it must be used to construct the Context object that will act as the backing Context.
2. Get all the Initial Context Factory Builder services. For each such service, in ranking order:
  - Ask the Initial Context Factory Builder service to create a new `InitialContextFactory` object. If this is null then continue with the next service.
  - Create the Context with the found Initial Context Factory and return it.
3. If no backing Context could be found using these steps, then the JNDI Context Manager service must throw a `No Initial Context Exception`.

### 126.3.2.2

#### No Implementation Class Specified

If the environment does not contain a value for the `java.naming.factory.initial` property then the following steps must be used to find a backing Context object.

1. Get all the Initial Context Factory Builder services. For each such service, in ranking order, do:
  - Ask the Initial Context Factory Builder service to create a new `InitialContextFactory` object. If this is null, then continue with the next service.
  - Create the backing Context object with the found Initial Context Factory service and return it.
2. Get all the Initial Context Factory services. For each such service, in ranking order, do:
  - Ask the Initial Context Factory service to create a new Context object. If this is null then continue with the next service otherwise create a new Context with the created Context as the backing Context.
3. If no Context has been found, an initial Context is returned without any backing. This returned initial Context can then only be used to perform URL based lookups.

### 126.3.3

#### Rebinding

A JNDI Provider can be added or removed to the service registry at any time because it is an OSGi service; OSGi services are by their nature dynamic. When a JNDI Provider unregisters an Initial Context Factory that was used to create a backing service then the JNDI Context Manager service must remove the association between any returned Contexts and their now invalid backing Contexts.

The JNDI Context Manager service must try to find a replacement whenever it is accessed and no backing Context is available. However, if no such replacement can be found the called function must result in throwing a `No Initial Context Exception`.

### 126.3.4

#### Life Cycle and Dynamism

When a client has finished with a Context object, then the client must close this Context object by calling the `close` method. When a Context object is closed, the resources held by the JNDI Implementation on the client's behalf for that Context must all be released. Releasing these resources must not affect other, independent, Context objects returned to the same client.

If a client ungets the JNDI Context Manager service, all the Context objects returned through that service instance must automatically be closed by the JNDI Context Manager. When the JNDI Context Manager service is unregistered, the JNDI Context Manager must automatically close all Contexts held.

For more information about life cycle issues, see also *Life Cycle Mismatch* on page 823.

## 126.4 JNDI Provider Admin service

JNDI provides a general object conversion service, see *Object and Reference Conversion* on page 813. For this specification, the responsibility of the static method on the NamingManager `getObjectInstance` is replaced with the JNDI Provider Admin service. The `JNDIProviderAdmin` interface provides the following methods that can be used to convert a description object to an object:

- `getObjectInstance(Object,Name,Context,Map)` - Used by Context implementations to convert a description object to another object.
- `getObjectInstance(Object,Name,Context,Map,Attributes)` - Used by a Dir Context implementations to convert a description object to another object.

In either case, the first argument is an object, called the *description*. JNDI allows a number of different Java types here. When either method is called, the following algorithm is followed to find a matching Object Factory to find/create the requested object. This algorithm is identical for both methods, except that the call that takes the `Attributes` argument consults Dir Object Factory services first and then Object Factory services while the method without the `Attributes` parameter only consults Object Factory services.

1. If the description object is an instance of `Referenceable`, then get the corresponding `Reference` object and use this as the description object.
2. If the description object is not a `Reference` object then goto step 5.
3. If a factory class name is specified, the JNDI Provider Admin service uses its own `Bundle Context` to search for a service registered under the `Reference`'s factory class name. If a matching `Object Factory` is found then it is used to create the object from the `Reference` object and the algorithm stops here.
4. If no factory class name is specified, iterate over all the `Reference` object's `StringRefAdrs` objects with the address type of `URL`. For each matching address type, use the value to find a matching `URL Context`, see *URL Context Provider* on page 819, and use it to recreate the object. See the Naming Manager for details. If an object is created then it is returned and the algorithm stops here.
5. Iterate over the `Object Factory Builder` services in ranking order. Attempt to use each such service to create an `ObjectFactory` or `DirObjectFactory` instance. If this succeeds (non null) then use this `ObjectFactory` or `DirObjectFactory` instance to recreate the object. If successful, the algorithm stops here.
6. If the description was a `Reference` and without a factory class name specified, or if the description was not of type `Reference`, then attempt to convert the object with each `Object Factory` service (or `Dir Object Factory` service for directories) service in ranking order until a non-null value is returned.
7. If no `ObjectFactory` implementations can be located to resolve the given description object, the description object is returned.

If an `Exception` occurs during the use of an `Object Factory Builder` service then this exception should be logged but must be ignored. If, however, an `Exception` occurs during the calling of a found `ObjectFactory` or `DirObjectFactory` object then this `Exception` must be re-thrown to the caller of the JNDI Provider Admin service.

## 126.5 JNDI Providers

JNDI Providers can be registered by registering an appropriate service. These services are consulted by the JNDI Implementation for creating a `Context` as well as creating/finding/converting general objects.

### 126.5.1 Initial Context Factory Builder Provider

An Initial Context Factory Builder provider is asked to provide an Initial Context Factory when no implementation class is specified or no such implementation can be found. An Initial Context Factory Builder service can be used by containers for other bundles to control the initial Context their applications receive.

An Initial Context Factory Builder provider must register an Initial Context Factory Builder service. The `service.ranking` property defines the iteration ordering of multiple Initial Context Factory Builder services. Implementations must be careful to correctly provide defaults.

For example, a container could use a thread local variable to mark the stack for a specific application. The implementation of the Initial Context Factory Builder can then detect specific calls from this application. To make the next code example work, an instance must be registered as an Initial Context Factory Builder service.

```
public class Container implements InitialContextFactoryBuilder {
    ThreadLocal<Application> apps;

    void startApp(final Application app) {
        Thread appThread = new Thread(app.getName()) {
            public void run() {
                apps.set(app);
                app.run();
            }
        }

        public InitialContextFactory
        createInitialContextFactory( Hashtable<?,?> ht ) {
            final Application app = apps.get();
            if ( app == null )
                return null;

            return new InitialContextFactory() {
                public Context getInitialContext( Hashtable<?,?>env ) {
                    return app.getContext(env);
                }
            };
        }
    }
}
```

### 126.5.2 Initial Context Factory Provider

An Initial Context Factory provides Contexts of a specific type. For example, those contexts allow communications with an LDAP server. An Initial Context Factory Provider must register the its Initial Context Factory service under the following names:

- *Implementation Class* - An Initial Context Factory provider must register a service under the name of the implementation class. This allows the JNDI Context Manager to find implementations specified in the environment properties.
- *Initial Context Factory* - As a general Initial Context Factory. If registered as such, it can be consulted for a default Initial Context. Implementations must be careful to only return a Context when the environment properties are appropriate. See *No Implementation Class Specified* on page 816

An Initial Context Factory service can create both `DirContext` as well as `Context` objects.

For example, SUN JREs for Java SE provide an implementation of a `Context` that can answer DNS questions. The name of the implementation class is a well known constant. The following class can be used with Declarative Services to provide a lazy implementation of a `DNSContext`:

```

public class DNSProvider implements InitialContextFactory{
    public Context createInitialContextFactory( Hashtable<?,?>env ) throws
        NamingException {
        try {
            Class<InitialContextFactory> cf = (Class<InitialContextFactory>)
                l.loadClass("com.sun.jndi.dns.DnsContextFactory" );
            InitialContextFactory icf = cf.newInstance();
            return icf.createInitialContextFactory(env);
        } catch( Throwable t ) {
            return null;
        }
    }
}

```

### 126.5.3 Object Factory Builder Provider

An Object Factory Builder provider must register an Object Factory Builder service. Such a service can be used to provide ObjectFactory and/or DirObjectFactory objects. An Object Factory Builder service is requested for such an object when no specific converter can be found. This service can be leveraged by bundles that act as a container for other bundles to control the object conversion for their subjects.

### 126.5.4 Object Factory Provider

An Object Factory provider can participate in the conversion of objects. It must register a service under the following names:

- *Implementation Class* - A service registered under its implementation class can be leveraged by a description that is a Reference object. Such an object can contain the name of the factory class. The implementation class can implement the DirObjectFactory interface or the ObjectFactory interface.
- *Object Factory* - The ObjectFactory interface is necessary to ensure class space consistency.
- *Dir Object Factory* - If the Object Factory provider can accept the additional Attributes argument in the getObjectInstance method of the JNDI Provider Admin service than it must also register as a Dir Object Factory service.

### 126.5.5 URL Context Provider

A *URL Context Factory* is a special type of an Object Factory service. A URL Context Factory must be registered as an Object Factory service with the following service property:

- *osgi.jndi.url.scheme* - The URL scheme associated with this URL Context, for example acme. The scheme must not contain the colon (':' \u003A).

A URL Context is used for URL based operations on an initial Context. For example, a lookup to acme:foo/javax.sql.DataSource must not use the provider based lookup mechanism of the backing Context but instead causes a lookup for the requested URL Context. A URL Context also provides a secondary mechanism for restoring Reference objects.

When an initial Context returned by the JNDI Context Manager service is given a URL based operation, it searches in the service registry for an Object Factory service that is published with the URL scheme property that matches the scheme used from the lookup request.

It then calls the getInstance method on the Object Factory service with the following parameters:

- *Object* - Should be either a String, String[], or null.
- *Name* - must be null
- *Context* - must be null

- *Hashtable* - The environment properties.

Calling the `getInstance` method must return a Context object. This context is then used to perform the lookup.

The life cycle of the Object Factory used to create the URL Context is tied to the JNDI context that was used to perform the URL based JNDI operation. By the time JNDI context is closed any Object-Factory objects held to process the URL lookups must be released (`unset`).

## 126.5.6 JRE Context Providers

The Java Runtime Environment (JRE) defines a number of default naming providers., see *Built-In JNDI Providers* on page 814. These naming providers are not OSGi aware, but are commonly used and are provided by the JRE. These naming providers rely on the `NamingManager` class for object conversion and finding URL Contexts.

The JRE default providers are made available by the JNDI Implementation. This JNDI Implementation must register a *built-in* Initial Context Factory Builder service that is capable of loading any `InitialContextFactory` classes of the JRE providers.

When this built-in Initial Context Factory Builder is called to create an `InitialContextFactory` object it must look in the environment properties that were given as an argument and extract the `java.naming.factory.initial` property; this property contains the name of the class of a provider. The built-in Initial Context Factory Builder then must use the bootstrap class loader to load the given `InitialContextFactory` class and creates a new instance with the no arguments constructor and return it. If this fails, it must return null. This mechanism will allow loading of any built-in providers.

This built-in Initial Context Factory Builder service must be registered with no `service.ranking` property. This will give it the default ranking and allows other providers to override the default.

## 126.6 OSGi URL Scheme

A URL scheme is available that allows JNDI based applications to access services in the service registry, see *Services and State* on page 822 about restrictions on these services. The URL scheme is specified as follows:

```
service ::= 'osgi:service/' query
query   ::= jndi-name | qname ( '/' filter )?
jndi-name ::= <any string>
```

No spaces are allowed between the terms.

This OSGi URL scheme can be used to perform a lookup of a single matching service using the interface name and filter. The URL Context must use the *owning bundle* to perform the service queries. The owning bundle is the bundle that requested the initial Context from the JNDI Context Manager service or received its Context through the `InitialContext` class. The returned objects must not be incompatible with the class space of the owning bundle.

The lookup for a URL with the `osgi:` scheme and service path returns the service with highest `service.ranking` and the lowest `service.id`. This scheme only allows a single service to be found. Multiple services can be obtained with the `osgi:` scheme and `servicelist` path:

```
servicelist ::= 'osgi:servicelist/' query?
```

If this `osgi:servicelist` scheme is used from a lookup method then a Context object is returned instead of a service object. Calling the `listBindings` method will produce a `NamingEnumeration` object that provides `Binding` objects. A `Binding` object contains the name, class of the service, and the service object. The bound object is the service object contained in the given Context.



When the Context class list method is called, the Naming Enumeration object provides a NameClassPair object. This NameClassPair object will include the name and class of each service in the Context. The list method can be useful in cases where a client wishes to iterate over the available services without actually getting them. If the service itself is required, then listBindings method should be used.

If multiple services matched the criteria listed in the URL, there would be more than one service available in the Context, and the corresponding Naming Enumeration would contain the same number of services.

If multiple services match, a call to listBindings on this Context would return a list of bindings whose name are a string with the service.id number, for example:

```
1283
```

Thus the following lookup is valid:

```
osgi: servicelist/ javax. sql. DataSource/ (&(db=mydb) (version=3. 1))
```

A service can provide a *JNDI service name* if it provides the following service property:

- `osgi.jndi.service.name` - An alternative name that the service can be looked up by when the `osgi:` URL scheme is used.

If a service is published with a JNDI service name then the service matches any URL that has this service name in the place of interface. For example, if the JNDI service name is `foo`, then the following URL selects this service:

```
osgi: service/ foo
```

Using a JNDI service name that can be interpreted as an interface name must be avoided, if this happens the result is undefined.

A JNDI client can also obtain the Bundle Context of the owning bundle by using the `osgi: scheme` namespace with the `framework/bundleContext` name. The following URL must return the Bundle Context of the owning bundle:

```
osgi: framework/ bundleContext
```

After the NamingEnumeration object has been used it must be closed by the client. Implementations must then unget any gotten services or perform other cleanup.

### 126.6.1 Service Proxies

The OSGi URL Context handles the complexities by hiding the dynamic nature of OSGi. The OSGi URL Context must handle the dynamics by *proxying* the service objects. This proxy must implement the interface given in the URL. If the JNDI service name instead of a class name is used, then all interfaces under which the service is registered must be implemented. If an interface is not compatible with the owning bundle's class space then it must not be implemented on the proxy, it must then be ignored. If this results in no implemented interfaces then an Illegal Argument Exception must be thrown.

Interfaces can always be proxied but classes are much harder. For this reason, an implementation is free to throw an Illegal Argument Exception when a class is used in the URL or in one of the registration names.

Getting the actual service object can be delayed until the proxy is actually used to call a method. If a method is called and the actual service has been unregistered, then the OSGi URL Context must attempt to rebind it to another service that matches the criteria given in the URL the next time it is

called. When no alternative service is available, a Service Exception with the UNREGISTERED type code must be thrown. Services obtained with the `osgi:` URL scheme must therefore be stateless because the rebinding to alternative services is not visible to the caller; there are no listeners defined for this rebinding, see *Services and State* on page 822.

If the reference was looked up using `osgi:service` then proxies must still be used, however, these proxies must not rebind when their underlying service is unregistered. Instead, they must throw a Service Exception with the UNREGISTERED type whenever the proxy is used and the proxied service is no longer available.

## 126.6.2 Services and State

A service obtained through a URL Context lookup is proxied. During the usage of this service, the JNDI Implementation can be forced to transparently rebind this service to another instance. The JNDI specification is largely intended for portability. For this reason, it has no mechanism architected to receive notifications about this rebinding. The client code is therefore unable to handle the dynamics.

The consequence of this model is that stateful services require extra care because applications cannot rely on the fact that they always communicate with the same service. Virtually all OSGi specified services have state.

# 126.7 Traditional Client Model

A JNDI Implementation must at startup register the `InitialContextFactoryBuilder` object and the `ObjectFactoryBuilder` object with the `NamingManager` class. As described in *JNDI Overview* on page 812, the JNDI code in the JRE will then delegate all Context related requests to the JNDI Implementation. Setting these singletons allows code that is not aware of the OSGi framework to use Context implementations from JNDI Providers registered with the OSGi service registry and that are managed as bundles. The JNDI Implementation therefore acts as a broker to the service registry for OSGi unaware code.

This brokering role can only be played when the JNDI Implementation can set the singletons as specified in *Naming Manager Singletons* on page 813. If the JNDI Implementation cannot set these singletons then it should log an error with the Log Service, if available. It can then not perform the following sections.

## 126.7.1 New Initial Context

The client typically requests a Context using the following code:

```
Hashtable env = new Hashtable();
env.put(Context.INITIAL_CONTEXT_FACTORY, "com.sun.jndi.ldap.LdapCtxFactory");
InitialContext ctx = new InitialContext(env);
```

The created `InitialContext` object is a facade for the real Context that is requested by the caller. It provides the bootstrapping mechanism for JNDI Provider pluggability. In order to obtain the provider's Context, the `InitialContext` class makes a call to the static `getContext` method on the `NamingManager` class. The JNDI code in the JRE then delegates any request for an initial Context object to the JNDI Implementation through the registered `InitialContextFactoryBuilder` singleton. The JNDI Implementation then determines the Bundle Context of the caller as described in *Caller's Bundle Context* on page 823. If no such Bundle Context can be found, a `NoInitialContextException` is thrown to the caller. This Bundle Context must be from an ACTIVE bundle.

This Bundle Context is then used to get the JNDI Context Manager service. This service is then used as described in *Context Creation* on page 815 to get an initial Context. This initial Context is then used in the `InitialContext` object as the *default initial context*. In this specification this is normally

called the backing context. An InitialContext object constructed through an Initial Context Factory Builder will not use the URL lookup mechanism, it must delegate all operations to the its backing context. A Context obtained through the JNDI Context Manager provides the URL lookup behavior instead.

### 126.7.2 Static Conversion

JNDI provides a general object conversion facility that is used by the URL Context and the process of restoring an object from a Reference object, see *Object and Reference Conversion* on page 813. A JNDI Implementation must take over this conversion by setting the static Object Factory Builder singleton, see *Naming Manager Singletons* on page 813. Non-OSGi aware Context implementations will use the NamingManager static getObjectInstance method for object conversion. This method then delegates to the set singleton Object Factory Builder to obtain an ObjectFactory object that understands how to convert the given description to an object. The JNDI Implementation must return an Object Factory that understands the OSGi service registry. If the getObjectInstance method is called on this object it must use the same rules as defined for the JNDI Provider Admin service getObjectInstance(Object,javax.naming.Name,javax.naming.Context,Map) method, see *JNDI Provider Admin service* on page 817. The Bundle Context that must be used with respect to this service is the caller's Bundle Context, see *Caller's Bundle Context* on page 823. If the Bundle Context is not found, the description object must be returned. The calling bundle must not be required to import the org.osgi.service.jndi package.

### 126.7.3 Caller's Bundle Context

The following mechanisms are used to determine the callers Bundle Context:

1. Look in the JNDI environment properties for a property called  
`org.osgi.service.jndi.bundleContext`  
If a value for this property exists then use it as the Bundle Context. If the Bundle Context has been found stop.
2. Obtain the Thread Context Class Loader; if it, or an ancestor class loader, implements the BundleReference interface, call its getBundle method to get the client's Bundle; then call getBundleContext on the Bundle object to get the client's Bundle Context. If the Bundle Context has been found stop.
3. Walk the call stack until the invoker is found. The invoker can be the caller of the InitialContext class constructor or the NamingManager or DirectoryManager getObjectInstance methods.
  - Get the class loader of the caller and see if it, or an ancestor, implements the BundleReference interface.
  - If a Class Loader implementing the BundleReference interface is found call the getBundle method to get the clients Bundle; then call the getBundleContext method on the Bundle to get the clients Bundle Context.
  - If the Bundle Context has been found stop, else continue with the next stack frame.

### 126.7.4 Life Cycle Mismatch

The use of static access to the JNDI mechanisms, NamingManager and InitialContext class methods, in the traditional client programming model produces several problems with regard to the OSGi life cycle. The primary problem being that there is no dependency management in place when static methods are used. These problems do not exist for the JNDI Context Manager service. Therefore, OSGi applications are strongly encouraged to use the JNDI Context Manager service.

The traditional programming model approach relies on two JVM singletons in the Naming Manager, see *Naming Manager Singletons* on page 813. The JNDI Implementation bundle must set both singletons before it registers its JNDI Context Manager service and JNDI Provider Admin service. However, in OSGi there is no defined start ordering, primarily because bundles can be updated at

any moment in time and will at such time not be available to provide their function anyway. For this reason, OSGi bundles express their dependencies with services.

The lack of start ordering means that a bundle could create an InitialContext object before the JNDI Implementation has had the chance to set the static Initial Context Factory Builder singleton. This means that the JNDI implementation inside the JRE will provide its default behavior and likely have to throw an exception. A similar exception is thrown for the Object Factory Builder singleton.

There is also a (small) possibility that a client will call new InitialContext() after the singletons have been set, but before the JNDI Context Manager and JNDI Provider Admin services have been registered. This specification requires that these services are set after the singletons are set. In this race condition the JNDI Implementation should throw a No Initial Context Exception, explaining that the JNDI services are not available yet.

## 126.8 Security

### 126.8.1 JNDI Implementation

A JNDI Implementation may wish to assert that the user of the provider has some relevant Java 2 security permission. Since the JNDI implementation is an intermediary between the JNDI client and provider this means that the JNDI implementation needs to have any permissions required to access any JNDI Provider. As a result the JNDI implementation needs All Permission. This will result in the JNDI clients permissions being checked to see if it has the relevant permission to access the JNDI Provider.

The JNDI Implementation must make any invocation to access these services in a doPrivileged check. A JNDI client must therefore not be required to have the following permissions, which are needed by a JNDI Implementation:

ServicePermission ..ObjectFactory	REGISTER, GET
ServicePermission ..DirObjectFactory	REGISTER, GET
ServicePermission ..ObjectFactoryBuilder	REGISTER, GET
ServicePermission ..InitialContextFactory	REGISTER, GET
ServicePermission ..InitialContextFactoryBuilder	REGISTER, GET
ServicePermission ..JNDIProviderAdmin	REGISTER, GET

The JNDI Implementation bundle must have the appropriate permissions to install the InitialContextFactoryBuilder and ObjectFactoryBuilder instances using the appropriate methods on the NamingManager class. This requires the following permission:

```
RuntimePermission "setFactory"
```

### 126.8.2 JNDI Clients

A JNDI client using the JNDI Context Manager service must have the following permissions:

ServicePermission ..JNDIContextManager	GET
----------------------------------------	-----

Obtaining a reference to a JNDI Context Manager service should be considered a privileged operation and should be guarded by permissions.

### 126.8.3 OSGi URL namespace

A JNDI client must not be able to obtain services or a Bundle Context that the client bundle would not be able to get via the core OSGi API. To allow a client to use the osgi namespace to get a service the bundle must have the corresponding Service Permission. When using the osgi namespace to obtain the Bundle Context the client bundle must have Admin Permission for the Bundle Context.

These permissions must be enforced by the osgi URL namespace handler. If there is no proper permission, the implementation must throw a Name Not Found Exception to prevent exposing the existence of such services.

## 126.9 org.osgi.service.jndi

JNDI Package Version 1.0.

Bundles wishing to use this package must list the package in the Import-Package header of the bundle's manifest. This package has two types of users: the consumers that use the API in this package and the providers that implement the API in this package.

Example import for consumers using the API in this package:

```
Import-Package: org.osgi.service.jndi; version="[1.0,2.0]"
```

Example import for providers implementing the API in this package:

```
Import-Package: org.osgi.service.jndi; version="[1.0,1.1]"
```

### 126.9.1 Summary

- JNDIConstants - Constants for the JNDI implementation.
- JNDIContextManager - This interface defines the OSGi service interface for the JNDIContextManager.
- JNDIProviderAdmin - This interface defines the OSGi service interface for the JNDIProviderAdmin service.

### 126.9.2 public class JNDIConstants

Constants for the JNDI implementation.

*Concurrency* Immutable

#### 126.9.2.1 public static final String BUNDLE\_CONTEXT = "osgi.service.jndi.bundleContext"

This JNDI environment property can be used by a JNDI client to indicate the caller's BundleContext. This property can be set and passed to an InitialContext constructor. This property is only useful in the "traditional" mode of JNDI.

#### 126.9.2.2 public static final String JNDI\_SERVICENAME = "osgi.jndi.service.name"

This service property is set on an OSGi service to provide a name that can be used to locate the service other than the service interface name.

#### 126.9.2.3 public static final String JNDI\_URLSCHEME = "osgi.jndi.url.scheme"

This service property is set by JNDI Providers that publish URL Context Factories as OSGi Services. The value of this property should be the URL scheme that is supported by the published service.

### 126.9.3 public interface JNDIContextManager

This interface defines the OSGi service interface for the JNDIContextManager. This service provides the ability to create new JNDI Context instances without relying on the InitialContext constructor.

*Concurrency* Thread-safe

#### 126.9.3.1 public Context newInitialContext() throws NamingException

- Creates a new JNDI initial context with the default JNDI environment properties.

*Returns* an instance of `javax.naming.Context`

*Throws* `NamingException`— upon any error that occurs during context creation

**126.9.3.2      `public Context newInitialContext(Map environment) throws NamingException`**

*environment* JNDI environment properties specified by caller

- Creates a new JNDI initial context with the specified JNDI environment properties.

*Returns* an instance of `javax.naming.Context`

*Throws* `NamingException`— upon any error that occurs during context creation

**126.9.3.3      `public DirContext newInitialDirContext() throws NamingException`**

- Creates a new initial `DirContext` with the default JNDI environment properties.

*Returns* an instance of `javax.naming.directory.DirContext`

*Throws* `NamingException`— upon any error that occurs during context creation

**126.9.3.4      `public DirContext newInitialDirContext(Map environment) throws NamingException`**

*environment* JNDI environment properties specified by the caller

- Creates a new initial `DirContext` with the specified JNDI environment properties.

*Returns* an instance of `javax.naming.directory.DirContext`

*Throws* `NamingException`— upon any error that occurs during context creation

**126.9.4      `public interface JNDIProviderAdmin`**

This interface defines the OSGi service interface for the `JNDIProviderAdmin` service. This service provides the ability to resolve JNDI References in a dynamic fashion that does not require calls to `NamingManager.getObjectInstance()`. The methods of this service provide similar reference resolution, but rely on the OSGi Service Registry in order to find `ObjectFactory` instances that can convert a Reference to an Object. This service will typically be used by OSGi-aware JNDI Service Providers.

*Concurrency* Thread-safe

**126.9.4.1      `public Object getObjectInstance(Object refInfo, Name name, Context context, Map environment) throws Exception`**

*refInfo* Reference info

*name* the JNDI name associated with this reference

*context* the JNDI context associated with this reference

*environment* the JNDI environment associated with this JNDI context

- Resolve the object from the given reference.

*Returns* an Object based on the reference passed in, or the original reference object if the reference could not be resolved.

*Throws* `Exception`— in the event that an error occurs while attempting to resolve the JNDI reference.

**126.9.4.2      `public Object getObjectInstance(Object refInfo, Name name, Context context, Map environment, Attributes attributes) throws Exception`**

*refInfo* Reference info

*name* the JNDI name associated with this reference

*context* the JNDI context associated with this reference

*environment* the JNDI environment associated with this JNDI context

*attributes* the naming attributes to use when resolving this object

- Resolve the object from the given reference.

*Returns* an Object based on the reference passed in, or the original reference object if the reference could not be resolved.

*Throws* Exception— in the event that an error occurs while attempting to resolve the JNDI reference.

## 126.10 References

- [1] *Java Naming and Directory Interface*  
<http://docs.oracle.com/javase/6/docs/technotes/guides/jndi/index.html>
- [2] *Java Naming and Directory Interface Tutorial from Sun Microsystems*  
<http://download.oracle.com/javase/6/docs/technotes/guides/jndi/index.html>
- [3] *JNDI Standard Property Names*  
<http://download.oracle.com/javase/1.5.0/docs/api/javax/naming/Context.html>





# 127 JPA Service Specification

## Version 1.0

### 127.1 Introduction

The Java Persistence API (JPA) is a specification that sets a standard for persistently storing objects in enterprise and non-enterprise Java based environments. JPA provides an Object Relational Mapping (ORM) model that is configured through persistence descriptors. This Java Persistence Service specification defines how persistence units can be published in an OSGi framework, how client bundles can find these persistence units, how database drivers are found with the OSGi JDBC Specification, as well as how JPA providers can be made available within an OSGi framework.

Applications can be managed or they can be unmanaged. Managed applications run inside a Java EE Container and unmanaged applications run in a Java SE environment. The managed case requires a provider interface that can be used by the container, while in the unmanaged case the JPA provider is responsible for supporting the client directly. This specification is about the unmanaged model of JPA except in the areas where the managed model is explicitly mentioned. Additionally, multiple concurrent providers for the unmanaged case are not supported.

This JPA Specification supports both [1] *JPA 1.0* and [2] *JPA 2.0*.

#### 127.1.1 Essentials

- *Dependencies* - There must be a way for persistence clients, if they so require, to manage their dependencies on a compatible persistence unit.
- *Compatibility* - The Persistence Unit service must be able to function in non-managed mode according to existing standards and interfaces outlined in the JPA specification.
- *Modularity* - Persistent classes and their accompanying configuration can exist in a separate bundle from the client that is operating on them using the Persistence Unit service.
- *JDBC* - Leverage the OSGi JDBC Specification for access to the database.

#### 127.1.2 Entities

- *JPA* - The Java Persistence API, [1] *JPA 1.0* and [2] *JPA 2.0*.
- *JPA Provider* - An implementation of JPA, providing the Persistence Provider and JPA Services to Java EE Containers and Client Bundles.
- *Interface Bundle* - A bundle containing the interfaces and classes in the javax.persistence namespace (and its sub-namespaces) that are defined by the JPA specification.
- *Persistence Bundle* - A bundle that includes, a Meta-Persistence header, one or more Persistence Descriptor resources, and the entity classes specified by the Persistence Units in those resources.
- *Client Bundle* - The bundle that uses the Persistence Bundle to retrieve and store objects.
- *Persistence Descriptor* - A resource describing one or more Persistence Units.
- *Persistence Unit* - A named configuration for the object-relational mappings and database access as defined in a Persistence Descriptor.
- *Entity Manager* - The interface that provides the control point of retrieving and persisting objects in a relational database based on a single Persistence Unit for a single session.

- *Entity Manager Factory* - A service that can create Entity Managers based on a Persistence Unit for different sessions.
- *Entity Manager Factory Builder* - A service that can build an Entity Manager Factory for a specific Persistence Unit with extra configuration parameters.
- *Managed Client* - A Client Bundle that is managed by a Container
- *Static Client* - A Client that uses the static factory methods in the Persistence class instead of services.
- *Static Persistence* - The actor that enables the use of the Persistence class static factory methods to obtain an Entity Manager Factory.
- *JDBC Provider* - The bundle providing a Data Source Factory service.

Figure 127.1

JPA Service overview

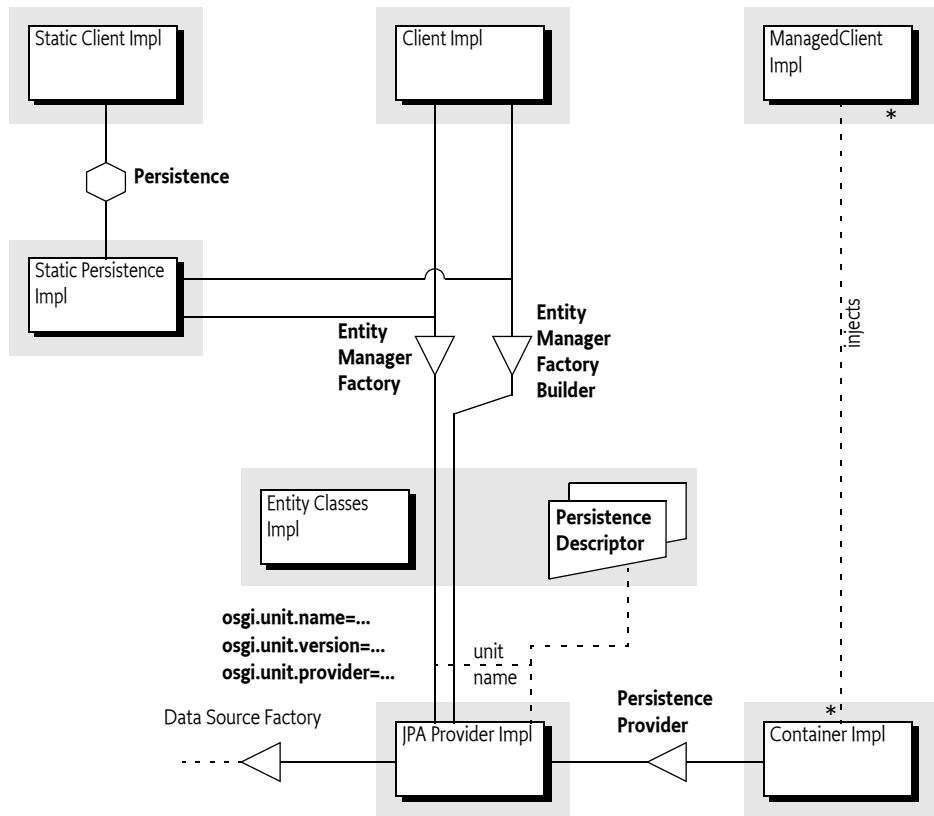

### 127.1.3

## Dependencies

This specification is based on JPA 1.0 and JPA 2.0. JPA 2.0 is backward compatible with JPA 1.0. For this reason, the versions of the packages follow the OSGi recommended version policy with the addition of a special JPA marker that annotates the specification version for JPA. All JPA Packages must also have an attribute called `jpa` that specifies the JPA version. The purpose of this attribute is to make it clear what JPA version belongs to this package.

Table 127.1

Dependency versions

JPA	Packages	Export Version	Client Import Range	Provider Imp. Range
JPA 1.0	<code>javax.persistence</code>	1.0	[1.0,2.0)	[1.0,1.1)
	<code>javax.persistence.spi</code>	1.0	[1.0,2.0)	[1.0,1.1)

JPA	Packages	Export Version	Client Import Range	Provider Imp. Range
JPA 2.0	javax.persistence	1.1	[1.1,2.0)	[1.1,1.2)
	javax.persistence.spi	1.1	[1.1,2.0)	[1.1,1.2)

For example, JPA should have an export declaration like:

```
Export-Package: javax.persistence; version=1.1; jpa=2.0, ...
```

### 127.1.4

## Synopsis

A JPA Provider tracks Persistence Bundles; a Persistence Bundle contains a Meta-Persistence manifest header. This manifest header enumerates the Persistence Descriptor resources in the Persistence Bundle. Each resource's XML schema is defined by the JPA 1.0 or JPA 2.0 specification. The JPA Provider reads the resource accordingly and extracts the information for one or more Persistence Units. For each found Persistence Unit, the JPA Provider registers an Entity Manager Factory Builder service. If the database is defined in the Persistence Unit, then the JPA Provider registers an Entity Manager Factory service during the availability of the corresponding Data Source Factory.

The identification of these services is handled through a number of service properties. The Entity Manager Factory service is named by the standard JPA interface, the Builder version is OSGi specific; it is used when the Client Bundle needs to create an Entity Manager Factory based on configuration properties.

A Client Bundle that wants to persist or retrieve its entity classes depends on an Entity Manager Factory (Builder) service that corresponds to a Persistence Unit that lists the entity classes. If such a service is available, the client can use this service to get an Entity Manager, allowing the client to retrieve and persist objects as long as the originating Entity Manager Factory (Builder) service is registered.

In a non-OSGi environment, it is customary to get an Entity Manager Factory through the Persistence class. This Persistence class provides a number of static methods that give access to any locally available JPA providers. This approach is not recommended in an OSGi environment due to class loading and start ordering issues. However, OSGi environments can support access through this static factory with a Static Persistence bundle.

## 127.2 JPA Overview

Java Persistence API (JPA) is a specification that is part of [3] *Java EE 5*. This OSGi Specification is based on [1] *JPA 1.0* and [2] *JPA 2.0*. This section provides an overview of JPA as specified in the JCP. The purpose of this section is to introduce the concepts behind JPA and define the terminology that will be used in the remainder of the chapter.

The purpose of JPA is to simplify access to relational databases for applications on the object-oriented Java platform. JPA provides support for storing and retrieving objects in a relational database. The JPA specification defines in detail how objects are mapped to tables and columns under the full control of the application. The core classes involved are depicted in Figure 127.2.

Figure 127.2 JPA Client View

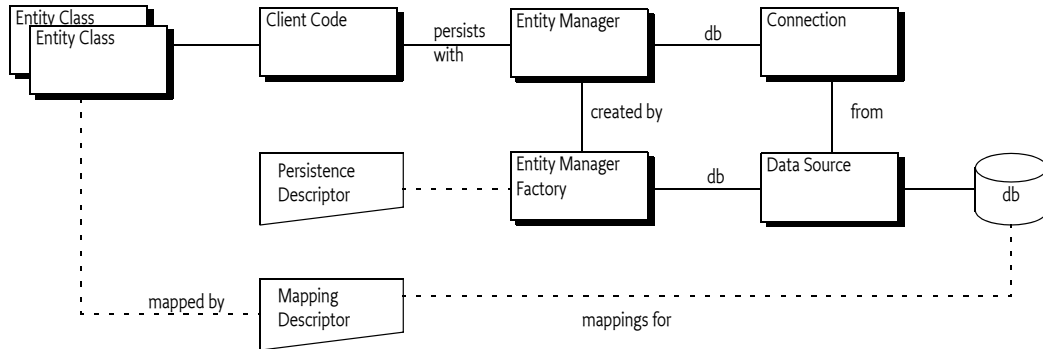

The JPA specifications define a number of concepts that are defined in this section for the purpose of this OSGi specification. However, the full syntax and semantics are defined in the JPA specifications.

### 127.2.1 Persistence

Classes that are stored and retrieved through JPA are called the *entity classes*. In this specification, the concept of entity classes includes the *embeddable* classes, which are classes that do not have any persistent identity, and mapped super classes that allow mappings, but are not themselves persistent. Entity classes are not required to implement any interface or extend a specific superclass, they are Plain Old Java Objects (POJOs). It is the responsibility of the *JPA Provider* to connect to a database and map the store and retrieve operations of the entity classes to their tables and columns. For performance reasons, the entity classes are sometimes *enhanced*. This enhancement can take place during build time, deploy time, or during class loading time. Some enhancements use byte code weaving, some enhancements are based on sub-classing.

The JPA Provider cannot automatically perform its persistence tasks; it requires configuration information. This configuration information is stored in the *Persistence Descriptor*. A Persistence Descriptor is an XML file according of one of the two following namespaces:

```

http://java.sun.com/xml/ns/persistence/persistence_1_0.xsd
http://java.sun.com/xml/ns/persistence/persistence_2_0.xsd

```

The JPA standard Persistence Descriptor must be stored in META-INF/persistence.xml. It is usually in the same class path entry (like a JAR or directory) as the entity classes.

The JPA Provider parses the Persistence Descriptor and extracts one or more *Persistence Units*. A Persistence Unit includes the following aspects:

- *Name* - Every Persistence Unit must have a name to identify it to clients. For example: Accounting.
- *Provider Selection* - Restriction to a specific JPA Provider, usually because there are dependencies in the application code on provider specific functionality.
- *JDBC Driver Selection* - Selects the JDBC driver, the principal and the credentials for selecting and accessing a relational database. See *JDBC Access in JPA* on page 834.
- *Properties* - Standard and JPA Provider specific properties.

The object-relational mappings are stored in special mapping resources or are specified in annotations.

A Persistence Unit can be *complete* or *incomplete*. A complete Persistence Unit identifies the database driver that is needed for the Persistence Unit, though it does not have to contain the credentials. An incomplete Persistence Unit lacks this information.

The relations between the class path, its entries, the entity classes, the Persistence Descriptor and the Persistence Unit is depicted in Figure 127.3 on page 833.

Figure 127.3 JPA Configuration

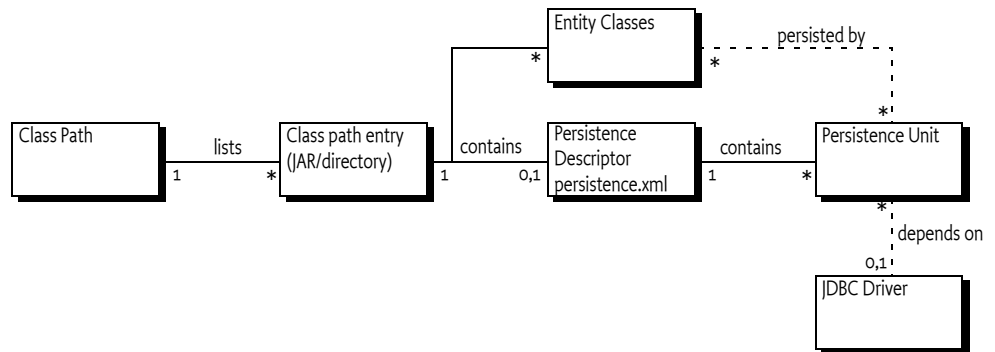

JPA recognizes the concept of a *persistence root*. The persistence root is the root of the JAR (or directory) on the class path that contains the META-INF/persistence.xml resource.

## 127.2.2

### JPA Provider

The JPA specifications provide support for multiple JPA Providers in the same application. An Application selects a JPA Provider through the Persistence class, using static factory methods. One of these methods accepts a map with *configuration properties*. Configuration properties can override information specified in a Persistence Unit or these properties add new information to the Persistence Unit.

The default implementation of the Persistence class discovers providers through the Java EE services model, this model requires a text resource in the class path entry called:

```
META-INF/services/javax.persistence.PersistenceProvider
```

This text resource contains the name of the JPA Provider implementation class.

The Persistence class createEntityManagerFactory method provides the JPA Provider with the name of a Persistence Unit. The JPA Provider must then scan the class path for any META-INF/persistence.xml entries, these are the available Persistence Descriptors. It then extracts the Persistence Units to find the requested Persistence Unit. If no such Persistence Unit can be found, or the JPA Provider is restricted from servicing this Persistence Unit, then null is returned. The Persistence class will then continue to try the next found or registered JPA Provider.

A Persistence Unit can restrict JPA Providers by specifying a *JPA Provider class*, this introduces a *provider dependency*. The specified JPA Provider class must implement the PersistenceProvider interface. This *implementation class name* must be available from the JPA Provider's documentation. JPA Providers that do not own the specified JPA Provider class must ignore such a Persistence Unit.

Otherwise, if the Persistence Unit is not restricted, the JPA Provider is *assigned* to this Persistence Unit; it must be ready to provide an EntityManagerFactory object when the application requests one.

The JPA Provider uses the Persistence Unit, together with any additional configuration properties, to construct an *Entity Manager Factory*. The application then uses this Entity Manager Factory to construct an *Entity Manager*, optionally providing additional configuration properties. The Entity Manager then provides the operations for the application to store and retrieve entity classes from the database.

The additional configuration properties provided with the creation of the Entity Manager Factory or the Entity Manager are often used to specify the database driver and the credentials. This allows the

Persistence Unit to be specified without committing to a specific database, leaving the choice to the application at runtime.

The relations between the application, Entity Manager, Entity Manager Factory and the JPA Provider are depicted in Figure 127.4 on page 834.

Figure 127.4

JPA Dynamic Model

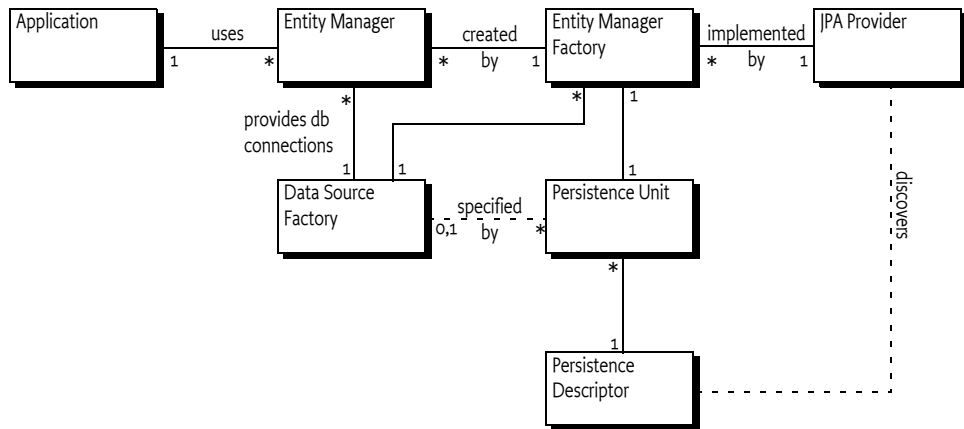

### 127.2.3 Managed and Unmanaged

The JPA specifications make a distinction between a *managed* and an *unmanaged* mode. In the managed mode the presence of a Java EE Container is assumed. Such a container provides many services for its contained applications like transaction handling, dependency injection, etc. One of these aspects can be the interface to the relational database. The JPA specifications therefore have defined a special method for Java EE Containers to manage the persistence aspects of their Managed Clients. This method is the `createContainerEntityManagerFactory` method on the `PersistenceProvider` interface. This method is purely intended for Java EE Containers and should not be used in other environments.

The other method on the `PersistenceProvider` interface is intended to be used by the `Persistence` class static factory methods. The `Persistence` class searches for an appropriate JPA Provider by asking all available JPA Providers to create an `EntityManagerFactory` based on configuration properties. The first JPA Provider that is capable of providing an `EntityManagerFactory` wins. The use of these static factory methods is called the *unmanaged mode*. It requires a JPA Provider to scan the class path to find the assigned Persistence Units.

### 127.2.4 JDBC Access in JPA

A Persistence Unit is configured to work with a relational database. JPA Providers communicate with a relational database through compliant JDBC database drivers. The database and driver parameters are specified in the Persistence Unit or configured during Entity Manager Factory or Entity Manager creation with the configuration properties. The configuration properties for selecting a database in non-managed mode were proprietary in JPA 1.0 but have been standardized in version 2.0 of JPA:

- `javax.persistence.jdbc.driver` - Fully-qualified name of the driver class
- `javax.persistence.jdbc.url` - Driver-specific URL to indicate database information
- `javax.persistence.jdbc.user` - User name to use when obtaining connections
- `javax.persistence.jdbc.password` - Password to use when obtaining connections

## 127.3 Bundles with Persistence

The primary goal of this specification is to simplify the programming model for bundles that need persistence. In this specification there are two application roles:

- *Persistence Bundle* - A Persistence Bundle contains the entity classes and one or more Persistence Descriptors, each providing one or more Persistence Units.
- *Client Bundle* - A Client Bundle contains the code that manipulates the entity classes and uses an Entity Manager to store and retrieve these entity classes with a relational database. The Client Bundle obtains the required Entity Manager(s) via a service based model.

These roles can be combined in a single bundle.

### 127.3.1 Services

A JPA Provider uses Persistence Units to provide Client Bundles with a configured *Entity Manager Factory* service and/or an *Entity Manager Factory Builder* service for each assigned Persistence Unit:

- *Entity Manager Factory service* - Provides an EntityManagerFactory object that depends on a complete Persistence Unit. That is, it is associated with a registered Data Source Factory service.
- *Entity Manager Factory Builder service* - The Entity Manager Factory Builder service provides the capability of creating an EntityManagerFactory object with additional configuration properties.

These services are collectively called the *JPA Services*. Entity Managers obtained from such JPA Services can only be used to operate on entity classes associated with their corresponding Persistence Unit.

### 127.3.2 Persistence Bundle

A *Persistence Bundle* is a bundle that specifies the Meta-Persistence header, see *Meta Persistence Header* on page 838. This header refers to one or more Persistence Descriptors in the Persistence Bundle. Commonly, this is the META-INF/persistence.xml resource. This location is the standard for non-OSGi environments, however an OSGi bundle can also use other locations as well as multiple resources.

For example, the contents of a simple Persistence Bundle with a single Person entity class could look like:

```
META-INF /
META-INF/MANIFEST.MF
OSGI-INF/address.xml
com/acme/Person.class
```

The corresponding manifest would then look like:

```
Manifest-Version: 1.0
Bundle-ManifestVersion: 2
Meta-Persistence: OSGI-INF/address.xml
Bundle-SymbolicName: com.acme.simple.persistence
Bundle-Version: 3.2.4.200912231004
```

A Persistence Bundle is a normal bundle; it must follow all the rules of OSGi and can use all OSGi constructs like Bundle-Classpath, fragment bundles, import packages, export packages, etc. However, there is one limitation: any entity classes must originate in the bundle's JAR, it cannot come from a fragment. This requirement is necessary to simplify enhancing entity classes.

### 127.3.3 Client Bundles

A Client Bundle uses the entity classes from a Persistence Bundle to provide its required functionality. To store and retrieve these entity classes a Client Bundle requires an Entity Manager that is configured for the corresponding Persistence Unit.

An Entity Manager is intended to be used by a single session, it is not thread safe. Therefore, a client needs an Entity Manager Factory to create an Entity Manager. In an OSGi environment, there are multiple routes to obtain an Entity Manager Factory.

A JPA Provider must register an Entity Manager Factory service for each assigned Persistence Unit that is *complete*. Complete means that it is a configured Persistence Unit, including the reference to the relational database. The Entity Manager Factory service is therefore bound to a Data Source Factory service and Client Bundles should not attempt to rebind the Data Source Factory with the configuration properties of the `createEntityManager(Map)` method. See *Rebinding* on page 842 for the consequences. If the Data Source Factory must be bound by the Client Bundle then the Client Bundle should use the *Custom Configured Entity Manager* on page 836.

The Entity Manager Factory service must be registered with the service properties as defined in *Service Registrations* on page 839. These are:

- `osgi.unit.name` - (String) The name of the Persistence Unit
- `osgi.unit.version` - (String) The version of the associated Persistence Bundle
- `osgi.unit.provider` - (String) The implementation class name of the JPA Provider

The life cycle of the Entity Manager Factory service is bound to the Persistence Bundle, the JPA Provider, and the selected Data Source Factory service.

A Client Bundle that wants to use an Entity Manager Factory service should therefore use an appropriate filter to select the Entity Manager Factory service that corresponds to its required Persistence Unit. For example, the following snippet uses Declarative Services, see *Declarative Services Specification* on page 289, to statically depend on such a service:

```
<reference name="accounting"
  target="( &amp; (osgi.unit.name=Accounting) (osgi.unit.version=3.2.*)) "
  interface="javax.persistence.EntityManagerFactory" />
```

### 127.3.4 Custom Configured Entity Manager

If a Client Bundle needs to provide configuration properties for the creation of an Entity Manager Factory it should use the *Entity Manager Factory Builder* service. This can for example be used to provide the database selection properties when the Persistence Unit is incomplete or if the database selection needs to be overridden.

The Entity Manager Factory Builder service's life cycle must not depend on the availability of any Data Source Factory, even if a JDBC driver class name is specified in the Persistence Descriptor. The Entity Manager Factory Builder service is registered with the same service properties as the corresponding Entity Factory service, see *Service Registrations* on page 839.

The following method is defined on the `EntityManagerFactoryBuilder` interface:

- `createEntityManagerFactory(Map)` - Returns a custom configured `EntityManagerFactory` instance for the Persistence Unit associated with the service. Accepts a map with the configuration properties to be applied during Entity Manager Factory creation. The method must return a proper Entity Manager Factory or throw an Exception.

The `createEntityManagerFactory` method allows standard and vendor-specific properties to be passed in and applied to the Entity Manager Factory being created. However, some properties cannot be honored by the aforementioned method. For example, the `javax.persistence.provider` JPA prop-



erty, as a means to specify a specific JPA Provider at runtime, cannot be supported because the JPA Provider has already been decided; it is the JPA Provider that registered the Entity Manager Factory Builder service. A JPA Provider should throw an Exception if it recognizes the property but it cannot use the property when specified through the builder. Unrecognized properties must be ignored.

Once an Entity Manager Factory is created the specified Data Source becomes associated with the Entity Manager Factory. It is therefore not possible to re-associate an Entity Manager Factory with another Data Source by providing different properties. A JPA Provider must throw an Exception when an attempt is made to re-specify the database properties. See *Rebinding* on page 842 for further information.

As an example, a sample snippet of a client that wants to operate on a persistence unit named Accounting and pass in the JDBC user name and password properties is:

```
ServiceReference[] refs = context.getServiceReferences(
    EntityManagerFactoryBuilder.class.getName(),
    "(osgi.unit.name=Accounting)");
if ( refs != null ) {
    EntityManagerFactoryBuilder emfBuilder =
        (EntityManagerFactoryBuilder) context.getService(refs[0]);
    if ( emfBuilder != null ) {
        Map<String, Object> props = new HashMap<String, Object>();
        props.put("javax.persistence.jdbc.user", userString);
        props.put("javax.persistence.jdbc.password", passwordString);
        EntityManagerFactory emf = emfBuilder.createEntityManagerFactory(props);
        EntityManager em = emf.createEntityManager();
        ...
    }
}
```

The example does not handle the dynamic dependencies on the associated Data Source Factory service.

## 127.4 Extending a Persistence Bundle

A Persistence Bundle is identified by its Meta-Persistence manifest header that references a number of Persistence Descriptor resources. Persistence bundles must be detected by a JPA Provider. The JPA Provider must parse any Persistence Descriptors in these bundles and detect the assigned Persistence Units. For each assigned Persistence Unit, the JPA Provider must register an Entity Manager Factory Builder service when the Persistence Bundle is ready, see *Ready Phase* on page 839.

For complete and assigned Persistence Units, the JPA Provider must find the required Data Source Factory service based on the driver name. When the Persistence Bundle is ready and the selected Data Source Factory is available, the JPA Provider must have an Entity Manager Factory service registered that is linked to that Data Source Factory.

When the Persistence Bundle is stopped (or the JPA Provider stops), the JPA Provider must close all connections and cleanup any resources associated with the Persistence Bundle.

This process is outlined in detail in the following sections.

### 127.4.1 Class Space Consistency

A JPA Provider must ignore Persistence Bundles that are in another class space for the `javax.persistence.*` packages. Such a JPA Provider cannot create JPA Services that would be visible and usable by the Client Bundles.

## 127.4.2 Meta Persistence Header

A *Persistence Bundle* is a bundle that contains the Meta-Persistence header. If this header is not present, then this specification does not apply and a JPA Provider should ignore the corresponding bundle.

The persistence root of a Persistence Unit is the root of the Persistence Bundle's JAR

The Meta-Persistence header has a syntax of:

```
Meta-Persistence ::= ( jar-path ( ',' jar-path)* )?
jar-path         ::= path ( '!'/' spath )?
spath           ::= path // must not start with solidus ('/' \u002F)
```

The header may include zero or more comma-separated jar-paths, each a path to a Persistence Descriptor resource in the bundle. Paths may optionally be prefixed with the solidus ('/' \u002F) character. The JPA Provider must always include the META-INF/persistence.xml first if it is not one of the listed paths. Wildcards in directories are not supported. The META-INF/persistence.xml is therefore the default location for an empty header.

For example:

```
Meta-Persistence: META-INF/jpa.xml, persistence/jpa.xml
```

The previous example will instruct the JPA Provider to process the META-INF/persistence.xml resource first, even though it is not explicitly listed. The JPA Provider must then subsequently process META-INF/jpa.xml and the persistence/jpa.xml resources.

The paths in the Meta-Persistence header must be used with the Bundle.getEntry() method, or a mechanism with similar semantics, to obtain the corresponding resource. The getEntry method does not force the bundle to resolve when still unresolved; resolving might interfere with the efficiency of any required entity class enhancements. However, the use of the getEntry method implies that fragment bundles cannot be used to contain Persistence Descriptors nor entity classes.

Paths in the Meta-Persistence header can reference JAR files that are nested in the bundle by using the !/ jar: URL syntax to separate the JAR file from the path within the JAR, for example:

```
Meta-Persistence: embedded.jar!/META-INF/persistence.xml
```

This example refers to a resource in the embedded.jar resource, located in the META-INF directory of embedded.jar.

The !/ splits the jar-path in a prefix and a suffix:

- *Prefix* - The prefix is a path to a JAR resource in the bundle.
- *Suffix* - The suffix is a path to a resource in the JAR identified by the prefix.

For example:

```
embedded.jar!/META-INF/persistence.xml
prefix:      embedded.jar
suffix:     META-INF/persistence.xml
```

It is not required that all listed or implied resources are present in the bundle's JAR. For example, it is valid that the default META-INF/persistence.xml resource is absent. However, if no Persistence Units are found at all then the absence of any Persistence Unit is regarded as an error that should be logged. In this case, the Persistence Bundle is further ignored.

## 127.4.3 Processing

A JPA Provider can detect a Persistence Bundle as early as its installation time. This early detection allows the JPA Provider to validate the Persistence Bundle as well as prepare any mechanisms to en-

hance the classes for better performance. However, this process can also be delayed until the bundle is started.

The JPA Provider must validate the Persistence Bundle. A valid Persistence Bundle must:

- Have no parsing errors of the Persistence Descriptors
- Validate all Persistence Descriptors against their schemas
- Have at least one assigned Persistence Unit
- Have all entity classes mentioned in the assigned Persistence Units on the Persistence Bundle's JAR.

A Persistence Bundle that uses multiple providers for its Persistence Units could become incompatible with future versions of this specification.

If any validation fails, then this is an error and should be logged. Such a bundle is ignored completely even if it also contains valid assigned Persistence Units. Only a bundle update can recover from this state.

Persistence Units can restrict JPA Providers by specifying a provider dependency. JPA Providers that do not own this JPA Provider implementation class must ignore such a Persistence Unit completely. Otherwise, if the JPA Provider can service a Persistence Unit, it assigns itself to this Persistence Unit.

If after the processing of all Persistence Descriptors, the JPA Provider has no assigned Persistence Units, then the JPA Provider must further ignore the Persistence Bundle.

#### 127.4.4 Ready Phase

A Persistence Bundle is *ready* when its state is ACTIVE or, when a lazy activation policy is used, STARTING. A JPA Provider must track the ready state of Persistence Bundles that contain assigned Persistence Units.

While a Persistence Bundle is ready, the JPA Provider must have, for each assigned Persistence Unit, an Entity Manager Factory Builder service registered to allow Client Bundles to create new EntityManagerFactory objects. The JPA Provider must also register an Entity Manager Factory for each assigned and complete Persistence Unit that has its corresponding Data Source available in the service registry.

The service registration process is asynchronous with the Persistence Bundle start because a JPA Provider could start after a Persistence Bundle became ready.

#### 127.4.5 Service Registrations

The JPA Services must be registered through the Bundle Context of the corresponding Persistence Bundle to ensure proper class space consistency checks by the OSGi Framework.

JPA Services are always related to an assigned Persistence Unit. To identify this Persistence Unit and the assigned JPA Provider, each JPA Service must have the following service properties:

- `osgi.unit.name` - (String) The name of the Persistence Unit. This property corresponds to the name attribute of the persistence-unit element in the Persistence Descriptor. It is used by Client Bundles as the primary filter criterion to obtain a JPA Service for a required Persistence Unit. There can be multiple JPA Services registered under the same `osgi.unit.name`, each representing a different version of the Persistence Unit.
- `osgi.unit.version` - (String) The version of the Persistence Bundle, as specified in Bundle-Version header, that provides the corresponding Persistence Unit. Client Bundles can filter their required JPA Services based on a particular Persistence Unit version.
- `osgi.unit.provider` - (String) The JPA Provider implementation class name that registered the service. The `osgi.unit.provider` property allows Client Bundles to know the JPA Provider that is servicing the Persistence Unit. Client Bundles should be careful when filtering on this proper-

ty, however, since the JPA Provider that is assigned a Persistence Unit may not be known by the Client Bundle ahead of time. If there is a JPA Provider dependency, it is better to specify this dependency in the Persistence Unit because other JPA Providers are then not allowed to assign such a Persistence Unit and will therefore not register a service.

### 127.4.6 Registering the Entity Manager Factory Builder Service

Once the Persistence Bundle is ready, a JPA Provider must register an Entity Manager Factory Builder service for each assigned Persistence Unit from that Persistence Bundle.

The Entity Manager Factory Builder service must be registered with the service properties listed in *Service Registrations* on page 839. The Entity Manager Factory Builder service is registered under the `org.osgi.service.jpa.EntityManagerFactoryBuilder` name. This interface is using the JPA packages and is therefore bound to one of the two supported versions, see *Dependencies* on page 830.

The Entity Manager Factory Builder service enables the creation of a parameterized version of an Entity Factory Manager by allowing the caller to specify configuration properties. This approach is necessary if, for example, the Persistence Unit is not complete.

### 127.4.7 Registering the Entity Manager Factory

A complete Persistence Unit is configured with a specific relational database driver, see *JDBC Access in JPA* on page 834. A JPA Provider must have an Entity Manager Factory service registered for each assigned and complete Persistence Unit when:

- The originating Persistence Bundle is ready, and
- A *matching* Data Source Factory service is available. Matching a Data Source Factory service to a Persistence Unit is discussed in *Database Access* on page 841.

A JPA Provider must track the life cycle of the matching Data Source Factory service; while this service is unavailable the Entity Manager Factory service must also be unavailable. Any active Entity Managers created by the Entity Manager Factory service become invalid to use at that time.

The Entity Manager Factory service must be registered with the same service properties as described for the Entity Manager Factory Builder service, see *Service Registrations* on page 839. It should be registered under the following name:

```
javax.persistence.EntityManagerFactory
```

The `EntityManagerFactory` interface is from the JPA packages and is therefore bound to one of the two supported versions, see *Dependencies* on page 830.

An Entity Manager Factory is bound to a Data Source Factory service because its assigned Persistence Unit was complete. However, a Client Bundle could still provide JDBC configuration properties for the `createEntityManager(Map)` method. This not always possible, see *Rebinding* on page 842.

### 127.4.8 Stopping

If a Persistence Bundle is being stopped, then the JPA Provider must ensure that any resources allocated on behalf of the Persistence Bundle are cleaned up and all open connections are closed. This cleanup must happen synchronously with the STOPPING event. Any Exceptions being thrown while cleaning up should be logged but must not stop any further clean up.

If the JPA Provider is being stopped, the JPA Provider must unregister all JPA Services that it registered through the Persistence Bundles and clean up as if those bundles were stopped.

## 127.5 JPA Provider

JPA Providers supply the implementation of the JPA Services and the Persistence Provider service. It is the responsibility of a JPA Provider to store and retrieve the entity classes from a relational database. It is the responsibility of the JPA Provider to register a Persistence Provider and start tracking Persistence Bundles, see *Extending a Persistence Bundle* on page 837.

### 127.5.1 Managed Model

A JPA Provider that supports running in managed mode should register a specific service for the Java EE Containers: the Persistence Provider service. The interface is the standard JPA Persistence-Provider interface. See *Dependencies* on page 830 for the issues around the multiple versions that this specification supports.

The service must be registered with the following service property:

- `javax.persistence.provider` - The JPA Provider implementation class name, a documented name for all JPA Providers.

The Persistence Provider service enables a Java EE Container to find a particular JPA Provider. This service is intended for containers only, not for Client Bundles because there are implicit assumptions in the JPA Providers about the Java EE environment. A Java EE Container must obey the life cycle of the Persistence Provider service. If this service is unregistered then it must close all connections and clean up the corresponding resources.

### 127.5.2 Database Access

A Persistence Unit is configured to work with a relational database. JPA Providers must communicate with a relational database through a compliant JDBC database driver. The database and driver parameters are specified with properties in the Persistence Unit or the configuration properties when a Entity Manager Factory Builder is used to build an Entity Manager Factory. All JPA Providers, regardless of version, in an OSGi environment must support the following properties for database access:

- `javax.persistence.jdbc.driver` - Fully-qualified name of the driver class.
- `javax.persistence.jdbc.url` - Driver-specific URL to indicate database information
- `javax.persistence.jdbc.user` - User name to use when obtaining connections
- `javax.persistence.jdbc.password` - Password to use when obtaining connections

There are severe limitations in specifying these properties after the Entity Manager Factory is created for the first time, see *Rebinding* on page 842.

### 127.5.3 Data Source Factory Service Matching

Providers must use the `javax.persistence.jdbc.driver` property, as defined in *JDBC Access in JPA* on page 834, to obtain a Data Source Factory service. The Data Source Factory is specified in *JDBC™ Service Specification* on page 801. The `javax.persistence.jdbc.driver` property must be matched with the value of the Data Source Factory service property named `osgi.jdbc.driver.class`.

The Data Source Factory service is registered with the `osgi.jdbc.driver.class` service property that holds the class name of the driver. This property must match the `javax.persistence.jdbc.driver` service property of the Persistence Unit.

For example, if the Persistence Unit specifies the `com.acme.db.Driver` database driver in the `javax.persistence.jdbc.driver` property (or in the Persistence Descriptor property element), then the following filter would select an appropriate Data Source Factory:

```
(&(objectClass=org.osgi.service.jdbc.DataSourceFactory)
 (osgi.jdbc.driver.class=com.acme.db.Driver))
```

Once the Data Source Factory is obtained, the JPA Provider must obtain a `DataSource` object. This Data Source object must then be used for all relational database access.

In [1] *JPA 1.0* the JPA JDBC properties were not standardized. JPA Providers typically defined a set of JDBC properties, similar to those defined in JPA 2.0, to configure JDBC driver access. JPA 1.0 JPA Providers must look up the Data Source Factory service first using the JPA 2.0 JDBC properties. If these properties are not defined then they should fall back to their proprietary driver properties.

#### 127.5.4 Rebinding

In this specification, the Entity Manager Factory service is only registered when the Persistence Unit is complete and a matching Data Source Factory service is available. However, the API of the Entity Manager Factory Builder allows the creation of an Entity Manager Factory with configuration properties. Those configuration properties could contain the JDBC properties to bind to another Data Source Factory service than it had already selected.

This case must not be supported by a JPA Provider, an `IllegalArgumentException` must be thrown. If such a case would be supported then the life cycle of the Entity Manager Factory service would still be bound to the first Data Source Factory. There would be no way for the JPA Provider to signal to the Client Bundle that the returned Entity Manager Factory is no longer valid because the rebound Data Source Factory was unregistered.

Therefore, when an Entity Manager Factory is being created using the Entity Manager Factory Builder, a JPA Provider must verify that the new properties are compatible with the properties of the already created Entity Manager Factory. If no, then an `Exception` must be thrown. If they are compatible, then an instance of the previous Entity Manager Factory should be returned.

#### 127.5.5 Enhancing Entity Classes

JPA Providers may choose to implement the JPA specifications using various implementation approaches and techniques. This promotes innovation in the area, but also opens the door to limitations and constraints arising due to implementation choices. For example, there are JPA Providers that perform byte code weaving during the entity class loading. Dynamic byte code weaving requires that the entity classes are not loaded until the JPA Provider is first able to intercept the loading of the entity class and be given an opportunity to do its weaving. It also implies that the Persistence Bundle and any other bundles that import packages from that bundle must be refreshed if the JPA Provider needs to be changed.

This is necessary because the JPA Services are registered against the Bundle Contexts of the Persistence Bundles and not the Bundle Context of the JPA Providers. Client Bundles must then unget the service to unbind themselves from the uninstalled JPA Provider. However, since most JPA Providers perform some kind of weaving or class transformation on the entity classes, the Persistence Bundle will likely need to be refreshed. This will cause the Client Bundles to be refreshed also because they depend on the packages of the entity classes.

#### 127.5.6 Class Loading

JPA Providers cannot have package dependencies on entity classes in Persistence Bundles because they cannot know at install time what Persistence Bundles they will be servicing. However, when a JPA Provider is servicing a Persistence Bundle, it must be able to load classes and resources from that Persistence Bundle according to the OSGi bundle rules. To do this class loading it must obtain a class loader that has the same visibility as the Persistence Bundle's bundle class loader. This will also allow it to load and manage metadata for the entity classes and resources for that Persistence Bundle's assigned Persistence Units. These resources and entity classes must reside directly in the Persistence Bundle, they must be accessed using the `getEntry` method. Entity classes and resources must not reside in fragments.

### 127.5.7 Validation

There is not yet an OSGi service specification defined for validation providers. If validation is required, the validation implementation will need to be included with the JPA Provider bundle.

## 127.6 Static Access

Non-managed client usage of JPA has traditionally been achieved through the Persistence class. Invoking a static method on the Persistence class is a dependency on the returned JPA Provider that cannot be managed by the OSGi framework.

However, such an unmanaged dependency is supported in this specification by the Static Persistence bundle. This bundle provides backwards compatibility for programs that use existing JPA access patterns. However, usage of this static model requires that the deployer ensures that the actors needed are in place at the appropriate times by controlling the life cycles of all participating bundles. The normal OSGi safe-guards and dependency handling do not work in the case of static access.

A Static Persistence Bundle must provide static access from the Persistence class to the JPA Services.

### 127.6.1 Access

There are two methods on the Persistence class:

- `createEntityManagerFactory(String)`
- `createEntityManagerFactory(String,Map)`

Both methods take the name of a Persistence Unit. The last method also takes a map that contains extra configuration properties. To support the usage of the static methods on the Persistence class, the implementation of the Persistence.createEntityManagerFactory method family must do a lookup of one of the JPA Services associated with the selected Persistence Unit.

If no configuration properties are specified, the Static Persistence Bundle must look for an Entity Manager Factory service with the `osgi.unit.name` property set to the given name. The default service should be used because no selector for a version is provided. If no such service is available, null must be returned. Provisioning of multiple versioned Persistence Units is not supported. Deployers should ensure only a single version of a Persistence Unit with the same name is present in an OSGi framework at any moment in time.

Otherwise, if configuration properties are provided, the Static Access implementation must look for an Entity Manager Factory Builder service with the `osgi.unit.name` property set to the given Persistence Unit name. If no such service exists, null must be returned. Otherwise, the default service must be used to create an Entity Manager Factory with the given configuration properties. The result must be returned to the caller.

For service lookups, the Static Persistence Bundle must use its own Bundle Context, it must not attempt to use the Bundle Context of the caller. All exceptions should be passed to the caller.

The class space of the Entity Manager Factory and the class space of the client cannot be enforced to be consistent by the framework because it is the Persistence class that is doing the lookup of the service, and not the actual calling Client Bundle that will be using the Entity Manager Factory. The framework cannot make the connection and therefore cannot enforce that the class spaces correspond. Deployers should therefore ensure that the involved class spaces are correctly wired.

## 127.7 Security

The security for this specification is based on the JPA specification.

## 127.8 org.osgi.service.jpa

JPA Package Version 1.0.

Bundles wishing to use this package must list the package in the Import-Package header of the bundle's manifest. This package has two types of users: the consumers that use the API in this package and the providers that implement the API in this package.

Example import for consumers using the API in this package:

```
Import-Package: org.osgi.service.jpa; version="[1.0,2.0]"
```

Example import for providers implementing the API in this package:

```
Import-Package: org.osgi.service.jpa; version="[1.0,1.1]"
```

### 127.8.1 Summary

- `EntityManagerFactoryBuilder` - This service interface offers JPA clients the ability to create instances of `EntityManagerFactory` for a given named persistence unit.

### 127.8.2 public interface EntityManagerFactoryBuilder

This service interface offers JPA clients the ability to create instances of `EntityManagerFactory` for a given named persistence unit. A service instance will be created for each named persistence unit and can be filtered by comparing the value of the `osgi.unit.name` property containing the persistence unit name. This service is used specifically when the caller wants to pass in factory-scoped properties as arguments. If no properties are being used in the creation of the `EntityManagerFactory` then the basic `EntityManagerFactory` service should be used.

#### 127.8.2.1 public static final String JPA\_UNIT\_NAME = "osgi.unit.name"

The name of the persistence unit.

#### 127.8.2.2 public static final String JPA\_UNIT\_PROVIDER = "osgi.unit.provider"

The class name of the provider that registered the service and implements the `JPA javax.persistence.PersistenceProvider` interface.

#### 127.8.2.3 public static final String JPA\_UNIT\_VERSION = "osgi.unit.version"

The version of the persistence unit bundle.

#### 127.8.2.4 public EntityManagerFactory createEntityManagerFactory(Map<String, Object> props)

*props* Properties to be used, in addition to those in the persistence descriptor, for configuring the `EntityManagerFactory` for the persistence unit.

- Return an `EntityManagerFactory` instance configured according to the properties defined in the corresponding persistence descriptor, as well as the properties passed into the method.

*Returns* An `EntityManagerFactory` for the persistence unit associated with this service. Must not be null.

## 127.9 References

- [1] *JPA 1.0*  
<http://jcp.org/en/jsr/summary?id=220>
- [2] *JPA 2.0*  
<http://jcp.org/en/jsr/summary?id=317>



- [3] *Java EE 5*  
<http://www.oracle.com/technetwork/java/javaee/tech/index.html>



# 128 Web Applications Specification

## Version 1.0

### 128.1 Introduction

The Java EE Servlet model has provided the backbone of web based applications written in Java. Given the popularity of the Servlet model, it is desirable to provide a seamless experience for deploying existing and new web applications to Servlet containers operating on the OSGi framework. Previously, the Http Service in the catalogue of OSGi compendium services was the only model specified in OSGi to support the Servlet programming model. However, the Http Service, as defined in that specification, is focused on the run time, as well as manual construction of the servlet context, and thus does not actually support the standard Servlet packaging and deployment model based on the Web Application Archive, or WAR format.

This specification defines the Web Application Bundle, which is a bundle that performs the same role as the WAR in Java EE. A WAB uses the OSGi life cycle and class/resource loading rules instead of the standard Java EE environment. WABs are normal bundles and can leverage the full set of features of the OSGi framework.

Web applications can also be installed as traditional WARs through a manifest rewriting process. During the install, a WAR is transformed into a WAB. This specification was based on ideas developed in [5] *PAX Web Extender*.

This Web Application Specification provides support for web applications written to the Servlet 2.5 specification, or later. Given that Java Server Pages, or JSPs, are an integral part of the Java EE web application framework, this specification also supports the JSP 2.1 specification or greater if present. This specification details how a web application packaged as a WAR may be installed into an OSGi framework, as well as how this application may interact with, and obtain, OSGi services.

#### 128.1.1 Essentials

- *Extender* - Enable the configuration of components inside a bundle based on configuration data provided by the bundle developer.
- *Services* - Enable the use of OSGi services within a Web Application.
- *Deployment* - Define a mechanism to deploy Web Applications, both OSGi aware and non OSGi aware, in the OSGi environment.
- *WAR File Support* - Transparently enhance the contents of a WAR's manifest during installation to add any headers necessary to deploy a WAR as an OSGi bundle.

#### 128.1.2 Entities

- *Web Container* - The implementation of this specification. Consists of a Web Extender, a Web URL Handler and a Servlet and Java Server Pages Web Runtime environment.
- *Web Application* - A program that has web accessible content. A Web Application is defined by [2] *Java EE Web Applications*.
- *Web Application Archive (WAR)* - The Java EE standard resource format layout of a JAR file that contains a deployable Web Application.
- *Web Application Bundle* - A Web Application deployed as an OSGi bundle, also called a WAB.
- *WAB* - The acronym for a Web Application Bundle.

- *Web Extender* - An extender bundle that deploys the Web Application Bundle to the Web Runtime based on the Web Application Bundle's state.
- *Web URL Handler* - A URL handler which transforms a Web Application Archive (WAR) to conform to the OSGi specifications during installation by installing the WAR through a special URL so that it becomes a Web Application Bundle.
- *Web Runtime* - A Java Server Pages and Servlet environment, receiving the web requests and translating them to servlet calls, either from Web Application servlets or other classes.
- *Web Component* - A Servlet or Java Server Page (JSP).
- *Servlet* - An object implementing the Servlet interface; this is for the request handler model in the Servlet Specification.
- *Servlet Context* - The model representing the Web Application in the Servlet Specification.
- *Java Server Page (JSP)* - A declarative, template based model for generating content through Servlets that is optionally supported by the Web Runtime.
- *Context Path* - The URI path prefix of any content accessible in a Web Application.

Figure 128.1

Web Container Entities

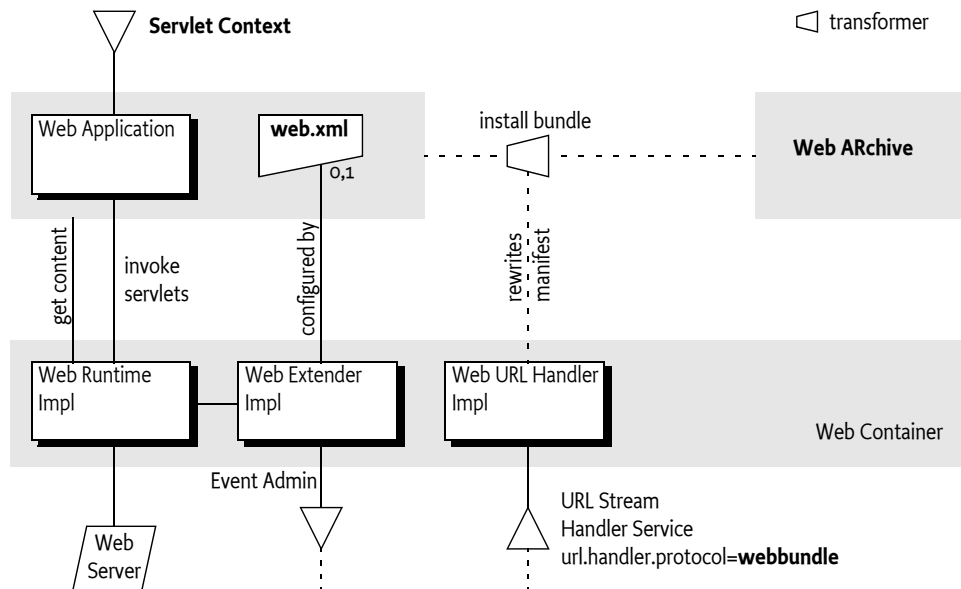

### 128.1.3 Dependencies

The package dependencies for the clients of this specification are listed in the following table.

Table 128.1

Dependency versions

Packages	Export Version	Client Import Range
javax.servlet	2.5	[2.5,3.0)
javax.servlet.http	2.5	[2.5,3.0)
javax.servlet.jsp.el	2.1	[2.1,3.0)
javax.servlet.jsp.jstl.core	1.2	[1.2,2.0)
javax.servlet.jsp.jstl.fmt	1.2	[1.2,2.0)
javax.servlet.jsp.jstl.sql	1.2	[1.2,2.0)
javax.servlet.jsp.jstl.tlv	1.2	[1.2,2.0)
javax.servlet.jsp.resources	2.1	[2.1,3.0)

Packages	Export Version	Client Import Range
javax.servlet.jsp.tagext	2.1	[2.1,3.0)
javax.servlet.jsp	2.1	[2.1,3.0)

JSP is optional for the Web Runtime.

### 128.1.4 Synopsis

The Web Application Specification is composed of a number of cooperating parts, which are implemented by a *Web Container*. A Web Container consists of:

- *Web Extender* - Responsible for deploying Web Application Bundles (WAB) to a Web Runtime,
- *Web Runtime* - Provides support for Servlet and optionally for JSPs, and
- *Web URL Handler* - Provides on-the-fly enhancements of non-OSGi aware Web ARchives (WAR) so that they can be installed as a WAB.

WABs are standard OSGi bundles with additional headers in the manifest that serve as deployment instructions to the Web Extender. WABs can also contain the Java EE defined `web.xml` descriptor in the `WEB-INF/` directory. When the Web Extender detects that a WAB is ready the Web Extender deploys the WAB to the Web Runtime using information contained in the `web.xml` descriptor and the appropriate manifest headers. The Bundle Context of the WAB is made available as a Servlet Context attribute. From that point, the Web Runtime will use the information in the WAB to serve content to any requests. Both dynamic as well as static content can be provided.

The Web URL Handler allows the deployment of an unmodified WAR as a WAB into the OSGi framework. This Web URL Handler provides a URL stream handler with the `webbundle:` scheme. Installing a WAR with this scheme allows the Web URL Handler to interpose itself as a filter on the input stream of the contents of the WAR, transforming the contents of the WAR into a WAB. The Web URL Handler rewrites the manifest by adding necessary headers to turn the WAR into a valid WAB. Additional headers can be added to the manifest that serve as instructions to the Web Extender.

After a WAB has been deployed to the Web Runtime, the Web Application can interact with the OSGi framework via the provided Bundle Context. The Servlet Context associated with this WAB follows the same life cycle as the WAB. That is, when the underlying Web Application Bundle is started, the Web Application is deployed to the Web Runtime. When the underlying Web Application Bundle is stopped because of a failure or other reason, the Web Application is undeployed from the Web Runtime.

## 128.2 Web Container

A Web Container is the implementation of this specification. It consists of the following parts:

- *Web Extender* - Detects Web Application Bundles (WAB) and tracks their life cycle. Ready WABs are deployed to the Web Runtime.
- *Web Runtime* - A runtime environment for a Web Application that supports the [3] *Servlet 2.5 specification* and [4] *JSP 2.1 specification* or later. The Web Runtime receives web requests and calls the appropriate methods on servlets. Servlets can be implemented by classes or Java Server Pages.
- *Web URL Handler* - A URL stream handler providing the `webbundle:` scheme. This scheme can be used to install WARs in an OSGi framework. The Web URL Handler will then automatically add the required OSGi manifest headers.

The extender, runtime, and handler can all be implemented in the same or different bundles and use unspecified mechanisms to communicate. This specification uses the defined names of the subparts as the actor; the term Web Container is the general name for this collection of actors.

## 128.3 Web Application Bundle

Bundles are the deployment and management entities under OSGi. A *Web Application Bundle* (WAB) is deployed as an OSGi bundle in an OSGi framework, where each WAB provides a single *Web Application*. A Web Application can make use of the [3] *Servlet 2.5 specification* and [4] *JSP 2.1 specification* programming models, or later, to provide content for the web.

A WAB is defined as a normal OSGi bundle that contains web accessible content, both static and dynamic. There are no restrictions on bundles. A Web Application can be packaged as a WAB during application development, or it can be transparently created at bundle install time from a standard Web Application aRchive (WAR) via transformation by the Web URL Handler, see *Web URL Handler* on page 854.

A WAB is a valid OSGi bundle and as such must fully describe its dependencies and exports (if any). As Web Applications are modularized further into multiple bundles (and not deployed as WAR files only) it is possible that a WAB can have dependencies on other bundles.

A WAB may be installed into the framework using the `BundleContext.installBundle` methods. Once installed, a WAB's life cycle is managed just like any other bundle in the framework. This life cycle is tracked by the Web Extender who will then deploy the Web Application to the Web Runtime when the WAB is ready and will undeploy it when the WAB is no longer ready. This state is depicted in Figure 128.2.

Figure 128.2 State diagram Web Application

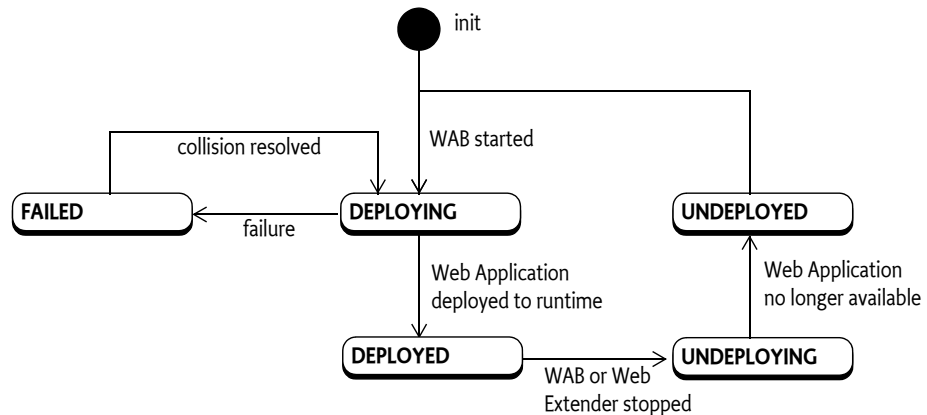

### 128.3.1 WAB Definition

A WAB is differentiated from non Web Application bundles through the specification of the additional manifest header:

```
Web-ContextPath ::= path
```

The `Web-ContextPath` header specifies the value of the *Context Path* of the Web Application. All web accessible content of the Web Application is available on the web server relative to this Context Path. For example, if the context path is `/sales`, then the URL would be something like: `http://www.acme.com/sales`. The Context Path must always begin with a solidus (`'/' \u002F`).

The Web Extender must not recognize a bundle as a Web Application unless the `Web-ContextPath` header is present in its manifest and the header value is a valid path for the bundle.

A WAB can optionally contain a `web.xml` resource to specify additional configuration. This `web.xml` must be found with the `Bundle.findEntries` method at the path:

WEB-INF/web.xml

The `findEntries` method includes fragments, allowing the `web.xml` to be provided by a fragment. The Web Extender must fully support a `web.xml` descriptor that specifies Servlets, Filters, or Listeners whose classes are required by the WAB.

### 128.3.2 Starting the Web Application Bundle

A WAB's Web Application must be *deployed* while the WAB is *ready*. Deployed means that the Web Application is available for web requests. Once deployed, a WAB can serve its web content on the given Context Path. Ready is when the WAB:

- Is in the ACTIVE state, or
- Has a lazy activation policy and is in the STARTING state.

The Web Extender should ensure that serving static content from the WAB does not activate the WAB when it has a lazy activation policy.

To deploy the WAB, the Web Extender must initiate the deploying of the Web Application into a Web Runtime. This is outlined in the following steps:

1. Wait for the WAB to become ready. The following steps can take place asynchronously with the starting of the WAB.
2. Post an `org/osgi/service/web/DEPLOYING` event. See *Events* on page 857.
3. Validate that the `Web-ContextPath` manifest header does not match the Context Path of any other currently deployed web application. If the Context Path value is already in use by another Web Application, then the Web Application must not be deployed, and the deployment fails, see *Failure* on page 852. The Web Extender should log the collision. If the prior Web Application with the same Context Path is undeployed later, this Web Application should be considered as a candidate, see *Stopping the Web Application Bundle* on page 853.
4. The Web Runtime processes deployment information by processing the `web.xml` descriptor, if present. The Web Container must perform the necessary initialization of Web Components in the WAB as described in the [3] *Servlet 2.5 specification*. This involves the following sub-steps in the given order:
  - Create a Servlet Context for the Web Application.
  - Instantiate configured Servlet event listeners.
  - Instantiate configured application filter instances etc.

The Web Runtime is required to complete instantiation of listeners prior to the start of execution of the first request into the Web Application by the Web Runtime. Attribute changes to the Servlet Context and Http Session objects can occur concurrently. The Servlet Container is not required to synchronize the resulting notifications to attribute listener classes. Listener classes that maintain state are responsible for the integrity of the data and should handle this case explicitly.

If event listeners or filters are used in the `web.xml`, then the Web Runtime will load the corresponding classes from the bundle activating the bundle if it was lazily started. Such a configuration will therefore not act lazily.

5. Publish the Servlet Context as a service with identifying service properties, see *Publishing the Servlet Context* on page 852.
6. Post an `org/osgi/service/web/DEPLOYED` event to indicate that the web application is now available. See *Events* on page 857.

If at any moment before the `org/osgi/service/web/DEPLOYED` event is published the deployment of the WAB fails, then the WAB deployment fails, see *Failure* on page 852.

### 128.3.3 Failure

Any validation failures must prevent the Web Application from being accessible via HTTP, and must result in a `org.osgi/service/web/FAILED` event being posted. See *Events* on page 857. The situation after the failure must be as if the WAB was never deployed.

### 128.3.4 Publishing the Servlet Context

To help management agents with tracking the state of Web Applications, the Web Extender must register the Servlet Context of the WAB as a service, using the Bundle Context of the WAB. The Servlet Context service must be registered with the service properties listed in the following table.

Table 128.2 *Servlet Context Service Properties*

Property Name	Type	Description
<code>osgi.web.symbolicname</code>	String	The symbolic name for the Web Application Bundle
<code>osgi.web.version</code>	String	The version of the Web Application Bundle. If no <code>Bundle-Version</code> is specified in the manifest then this property must not be set.
<code>osgi.web.contextpath</code>	String	The Context Path from which the WAB's content will be served.

### 128.3.5 Static Content

A deployed WAB provides content on requests from the web. For certain access paths, this can serve content from the resources of the web application: this is called *static content*. A Web Runtime must use the Servlet Context resource access methods to service static content, the resource loading strategy for these methods is based on the `findEntries` method, see *Resource Lookup* on page 858. For confidentiality reasons, a Web Runtime must not return any static content for paths that start with one of the following prefixes:

WEB-INF/  
OSGI-INF/  
META-INF/  
OSGI-OPT/

These *protected directories* are intended to shield code content used for dynamic content generation from accidentally being served over the web, which is a potential attack route. In the servlet specification, the WEB-INF/ directory in the WAR is protected in such a way. However, this protection is not complete. A dependent JAR can actually be placed outside the WEB-INF directory that can then be served as static content. The same is true for a WAB. Though the protected directories must never be served over the web, there are no other checks required to verify that no content can be served that is also available from the Bundle class path.

It is the responsibility of the author of the WAB to ensure that confidential information remains confidential by placing it in one of the protected directories. WAB bundles should be constructed in such a way that they do not accidentally expose code or confidential information. The simplest way to achieve this is to follow the WAR model where code is placed in the WEB-INF/classes directory and this directory is placed on the Bundle's class path as the first entry. For example:

Bundle-ClassPath: WEB-INF/classes, WEB-INF/lib/acme.jar

### 128.3.6 Dynamic Content

Dynamic content is content that uses code to generate the content, for example a servlet. This code must be loaded from the bundle with the `Bundle loadClass` method, following all the Bundle class path rules.



Unlike a WAR, a WAB is not constrained to package classes and code resources in the WEB-INF/classes directory or dependent JARs in WEB-INF/lib/ only. These entries can be packaged in any way that's valid for an OSGi bundle as long as such directories and JARs are part of bundle class path as set with the Bundle-ClassPath header and any attached fragments. JARs that are specified in the Bundle-ClassPath header are treated like JARs in the WEB-INF/lib/ directory of the Servlet specification. Similarly, any directory that is part of the Bundle-ClassPath header is treated like WEB-INF/classes directory of the Servlet specification.

Like WARs, code content that is placed outside the protected directories can be served up to clients as static content.

### 128.3.7 Content Serving Example

This example consists of a WAB with the following contents:

```
acme.jar:
  Bundle-ClassPath: WEB-INF/classes, LIB/bar.jar
  Web-ContextPath: /acme

  WEB-INF/lib/foo.jar
  LIB/bar.jar
  index.html
  favicon.ico
```

The content of the embedded JARs foo.jar and bar.jar is:

```
foo.jar:          bar.jar:
  META-INF/foo.tld  META-INF/bar.tld
  foo/FooTag.class  bar/BarTag.class
```

Assuming there are no special rules in place then the following lists specifies the result of a number of web requests for static content:

```
/acme/index.html      acme.wab: index.html
/acme/favicon.ico     acme.wab: favicon.ico
/acme/WEB-INF/lib/foo.jar  not found because protecteddirectory
/acme/LIB/bar.jar       acme.wab: LIB/bar.jar (code, but not protected)
```

In this example, the tag classes in bar.jar must be found (if JSP is supported) but the tag classes in foo.jar must not because foo.jar is not part of the bundle class path.

### 128.3.8 Stopping the Web Application Bundle

A web application is stopped by stopping the corresponding WAB. In response to a WAB STOPPING event, the Web Extender must *undeploy* the corresponding Web Application from the Servlet Container and clean up any resources. This undeploying must occur synchronously with the WAB's stopping event. This will involve the following steps:

1. An `org.osgi/service/web/UNDEPLOYING` event is posted to signal that a Web Application will be removed. See *Events* on page 857.
2. Unregister the corresponding Servlet Context service
3. The Web Runtime must stop serving content from the Web Application.
4. The Web Runtime must clean up any Web Application specific resources as per servlet 2.5 specification.
5. Emit an `org.osgi/service/web/UNDEPLOYED` event. See *Events* on page 857.
6. It is possible that there are one or more *colliding* WABs because they had the same Context Path as this stopped WAB. If such colliding WABs exists then the Web Extender must attempt to deploy the colliding WAB with the lowest bundle id.

Any failure during undeploying should be logged but must not stop the cleaning up of resources and notification of (other) listeners as well as handling any collisions.

### 128.3.9 Uninstalling the Web Application Bundle

A web application can be uninstalled by uninstalling the corresponding WAB. The WAB will be uninstalled from the OSGi framework.

### 128.3.10 Stopping of the Web Extender

When the Web Extender is stopped all deployed WABs are undeployed as described in *Stopping the Web Application Bundle* on page 853. Although the WAB is undeployed it remains in the ACTIVE state. When the Web Extender leaves the STOPPING state all WABs will have been undeployed.

## 128.4 Web URL Handler

The Web URL Handler acts as a filter on the Input Stream of an install operation. It receives the WAB or WAR and it then generates a JAR that conforms to the WAB specification by rewriting the manifest resource. This process is depicted in Figure 128.3.

Figure 128.3

Web URL Handler

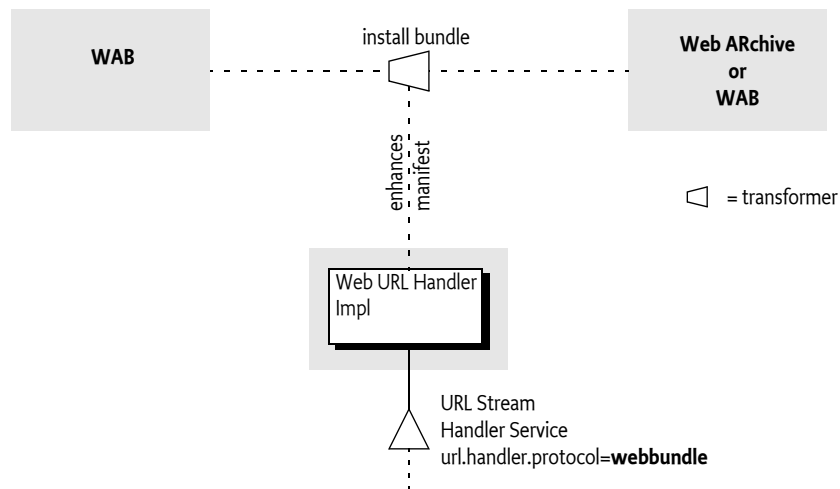

When the Web Container bundle is installed it must provide the `webbundle:` scheme to the URL class. The Web URL Handler has two primary responsibilities:

- *WAB* - If the source is already a bundle then only the `Web-ContextPath` can be set or overwritten.
- *WAR* - If the source is a WAR (that is, it must not contain any OSGi defined headers) then convert the WAR into a WAB.

The Web URL Handler can take parameters from the query arguments of the install URL, see *URL Parameters* on page 855.

The URL handler must validate query parameters, and ensure that the manifest rewriting results in valid OSGi headers. Any validation failures must result in `Bundle Exception` being thrown and the bundle install must fail.

Once a WAB is generated and installed, its life cycle is managed just like any other bundle in the framework.

### 128.4.1 URL Scheme

The Web URL Handler's scheme is defined to be:

```
scheme      ::= 'webbundle:' embedded '?' web-params
embedded    ::= <embedded URL according to RFC 1738>
web-params  ::= ( web-param ( '&' web-param )* )?
web-param   ::= <key> '=' <value>
```

The web-param <key> and <value> as well as the <embedded url> must follow [6] *Uniform Resource Locators, RFC 1738* for their escaping and character set rules. A Web URL must further follow all the rules of a URL. Whitespaces are not allowed between terms.

An example for a webbundle: URL:

```
webbundle:http://www.acme.com:8021/sales.war?Web-ContextPath=/sales
```

Any URL scheme understood by the framework can be embedded, such as an http:, or file: URL. Some forms of embedded URL also contain URL query parameters and this must be supported. The embedded URL must be encoded as a standard URL. That is, the control characters like colon (':' \u003A), solidus ('/' \u002F), percent ('%' \u0025), and ampersand ('&' \u0026) must not be encoded. Thus the value returned from the `getPath` method may contain a query part. Any implementation must take care to preserve both the query parameters for the embedded URL, and for the complete webbundle: URL. A question mark must always follow the embedded URL to simplify this processing. The following example shows an HTTP URL with some query parameters:

```
webbundle:http://www.acme.com/sales?id=123?Bundle-SymbolicName=com.example&
Web-ContextPath=/
```

### 128.4.2 URL Parsing

The URL object for a webbundle: URL must return the following values for the given methods:

- `getProtocol` - webbundle
- `getPath` - The complete embedded URL
- `getQuery` - The parameters for processing of the manifest.

For the following example:

```
webbundle:http://acme.com/repo?war=example.war?Web-ContextPath=/sales
```

The aforementioned methods must return:

- `getProtocol` - webbundle
- `getPath` - http://acme.com/repo?war=example.war
- `getQuery` - Web-ContextPath=/sales

### 128.4.3 URL Parameters

All the parameters in the webbundle: URL are optional except for the Web-ContextPath parameter. The parameter names are case insensitive, but their values must be treated as case sensitive. Table 128.3 describes the parameters that must be supported by any webbundle: URL Stream handler. A Web URL Handler is allowed to support additional parameters.

Table 128.3 *Web bundle URL Parameters*

Parameter Name	Description
Bundle-SymbolicName	The desired symbolic name for the resulting WAB.

Parameter Name	Description
Bundle-Version	The version of the resulting WAB. The value of this parameter must follow the OSGi versioning syntax.
Bundle-ManifestVersion	The desired bundle manifest version. Currently, the only valid value for this parameter is 2.
Import-Package	A list of packages that the war file depends on.
Web-ContextPath	The Context Path from which the Servlet Container should serve content from the resulting WAB. This is the only valid parameter when the input JAR is already a bundle. This parameter must be specified.

#### 128.4.4 WAB Modification

The Web URL Handler can set or modify the Web-ContextPath of a WAB if the input source is already a bundle. It must be considered as a bundle when any of the OSGi defined headers listed in Table 128.3 is present in the bundle.

For WAB Modification, the Web URL Handler must only support the Web-ContextPath parameter and it must not modify any existing headers other than the Web-ContextPath. Any other parameter given must result in a Bundle Exception.

#### 128.4.5 WAR Manifest Processing

The Web URL Handler is designed to support the transparent deployment of Java EE Web ARchives (WAR). Such WARs are ignorant of the requirements of the underlying OSGi framework that hosts the Web Runtime. These WARs are not proper OSGi bundles because they do not contain the necessary metadata in the manifest. For example, a WAR without a Bundle-ManifestVersion, Import-Package, and other headers cannot operate in an OSGi framework.

The Web URL Handler implementation copies the contents of the embedded URL to the output and rewrites the manifest headers based on the given parameters. The result must be a WAB.

Any parameters specified must be treated as manifest headers for the web. The following manifest headers must be set to the following values if not specified:

- Bundle-ManifestVersion - Must be set to 2.
- Bundle-SymbolicName - Generated in an implementation specific way.
- Bundle-ClassPath - Must consist of:
  - WEB-INF/classes
  - All JARs from the WEB-INF/lib directory in the WAR. The order of these embedded JARs is unspecified.
  - If these JARs declare dependencies in their manifest on other JARs in the bundle, then these jars must also be appended to the Bundle-ClassPath header. The process of detecting JAR dependencies must be performed recursively as indicated in the Servlet Specification.
- Web-ContextPath - The Web-ContextPath must be specified as a parameter. This Context Path should start with a leading solidus ('/' \u002F). The Web URL handler must add the preceding solidus if it is not present.

The Web URL Handler is responsible for managing the import dependencies of the WAR. Implementations are free to handle the import dependencies in an implementation defined way. They can augment the Import-Package header with byte-code analysis information, add a fixed set of clauses, and/or use the DynamicImport-Package header as last resort.

Any other manifest headers defined as a parameter or WAR manifest header not described in this section must be copied to the WAB manifest by the Web URL Handler. Such an header must not be modified.

### 128.4.6 Signed WAR files

When a signed WAR file is installed using the Web URL Handler, then the manifest rewriting process invalidates the signatures in the bundle. The OSGi specification requires fully signed bundles for security reasons, security resources in partially signed bundles are ignored.

If the use of the signing metadata is required, the WAR must be converted to a WAB during development and then signed. In this case, the Web URL Handler cannot be used. If the Web URL Handler is presented with a signed WAR, the manifest name sections that contain the resource's checksums must be stripped out by the URL stream handler. Any signer files (\*.SF and their corresponding DSA/RSA signature files) must also be removed.

## 128.5 Events

The Web Extender must track all WABs in the OSGi framework in which the Web Extender is installed. The Web Extender must post Event Admin events, which is asynchronous, at crucial points in its processing. The topic of the event must be one of the following values:

- `org/osgi/service/web/DEPLOYING` - The Web Extender has accepted a WAB and started the process of deploying a Web Application.
- `org/osgi/service/web/DEPLOYED` - The Web Extender has finished deploying a Web Application, and the Web Application is now available for web requests on its Context Path.
- `org/osgi/service/web/UNDEPLOYING` - The web extender started undeploying the Web Application in response to its corresponding WAB being stopped or the Web Extender is stopped.
- `org/osgi/service/web/UNDEPLOYED` - The Web Extender has undeployed the Web Application. The application is no longer available for web requests.
- `org/osgi/service/web/FAILED` - The Web Extender has failed to deploy the Web Application, this event can be fired after the DEPLOYING event has fired and indicates that no DEPLOYED event will be fired.

For each event topic above, the following properties must be published:

- `bundle.symbolicName` - (String) The bundle symbolic name of the WAB.
- `bundle.id` - (Long) The bundle id of the WAB.
- `bundle` - (Bundle) The Bundle object of the WAB.
- `bundle.version` - (Version) The version of the WAB.
- `context.path` - (String) The Context Path of the Web Application.
- `timestamp` - (Long) The time when the event occurred
- `extender.bundle` - (Bundle) The Bundle object of the Web Extender Bundle
- `extender.bundle.id` - (Long) The id of the Web Extender Bundle.
- `extender.bundle.symbolicName` - (String) The symbolic name of the Web Extender Bundle.
- `extender.bundle.version` - (Version) The version of the Web Extender Bundle.

In addition, the `org/osgi/service/web/FAILED` event must also have the following property:

- `exception` - (Throwable) If an exception caused the failure, an exception detailing the error that occurred during the deployment of the WAB.
- `collision` - (String) If a name collision occurred, the Web-ContextPath that had a collision
- `collision.bundles` - (Collection<Long>) If a name collision occurred, a collection of bundle ids that all have the same value for the Web-ContextPath manifest header.

## 128.6 Interacting with the OSGi Environment

### 128.6.1 Bundle Context Access

In order to properly integrate in an OSGi environment, a Web Application can access the OSGi service registry for publishing its services, accessing services provided by other bundles, and listening to bundle and service events to track the life cycle of these artifacts. This requires access to the Bundle Context of the WAB.

The Web Extender must make the Bundle Context of the corresponding WAB available to the Web Application via the Servlet Context `osgi-bundlecontext` attribute. A Servlet can obtain a Bundle Context as follows:

```
BundleContext ctxt = (BundleContext)
    servletContext.getAttribute("osgi-bundlecontext");
```

### 128.6.2 Other Component Models

Web Applications sometimes need to inter-operate with services provided by other component models, such as a Declarative Services or Blueprint. Per the Servlet specification, the Servlet Container owns the life cycle of a Servlet; the life cycle of the Servlet must be subordinate to the life cycle of the Servlet Context, which is only dependent on the life cycle of the WAB. Interactions between different bundles are facilitated by the OSGi service registry. This interaction can be managed in several ways:

- A Servlet can obtain a Bundle Context from the Servlet Context for performing service registry operations.
- Via the JNDI Specification and the `osgi:service` JNDI namespace. The OSGi JNDI specification describes how OSGi services can be made available via the JNDI URL Context. It defines an `osgi:service` namespace and leverages URL Context factories to facilitate JNDI integration with the OSGi service registry.

Per this specification, it is not possible to make the Servlet life cycle dependent on the availability of specific services. Any synchronization and service dependency management must therefore be done by the Web Application itself.

### 128.6.3 Resource Lookup

The `getResource` and `getResourceAsStream` methods of the ServletContext interface are used to access resources in the web application. For a WAB, these resources must be found according to the `findEntries` method, this method includes fragments. For the `getResource` and `getResourceAsStream` method, if multiple resources are found, then the first one must be used.

Since the `getResource` and `getResourceAsStream` methods do not support wildcards while the `findEntries` method does it is necessary to escape the wildcard asterisk (`'*' \u002A`) with prefixing it with a reverse solidus (`'\' \u005C`). This implies that a reverse solidus must be escaped with an extra reverse solidus. For example, the path `foo\bar*` must be escaped to `foo\\bar\*`.

The `getResourcePaths` method must map to the Bundle `getEntryPaths` method, its return type is a Set and can not handle multiples. However, the paths from the `getEntryPaths` method are relative while the methods of the `getResourcePaths` must be absolute.

For example, assume the following manifest for a bundle:

```
Bundle-ClassPath: localized, WEB-INF
...
```

This WAB has an attached fragment `acme-de.jar` with the following content:

META-INF/MANIFEST.MF  
localized/logo.png

The `getResource` method for `localized/logo.png` uses the `findEntries` method to find a resource in the directory `/localized` and the resource `logo.png`. Assuming the host bundle has no `localized/` directory, the Web Runtime must serve the `logo.png` resource from the `acme-de.jar`.

### 128.6.4 Resource Injection and Annotations

The Web Application `web.xml` descriptor can specify the `metadata-complete` attribute on the `web-app` element. This attribute defines whether the `web.xml` descriptor is *complete*, or whether the classes in the bundle should be examined for deployment annotations. If the `metadata-complete` attribute is set to `true`, the Web Runtime must ignore any servlet annotations present in the class files of the Web Application. Otherwise, if the `metadata-complete` attribute is not specified, or is set to `false`, the container should process the class files of the Web Application for annotations, if supported.

A WAB can make use of the annotations defined by [7] *JSR 250 Common Annotations for the Java Platform* if supported by the Web Extender. Such a WAB must import the packages the annotations are contained in. A Web Extender that does not support the use of JSR 250 annotations must not process a WAB that imports the annotations package.

### 128.6.5 Java Server Pages Support

Java Server Pages (JSP) is a rendering technology for template based web page construction. This specification supports [4] *JSP 2.1 specification* if available with the Web Runtime. The `servlet` element in a `web.xml` descriptor is used to describe both types of Web Components. JSP components are defined implicitly in the `web.xml` descriptor through the use of an implicit `.jsp` extension mapping, or explicitly through the use of a `jsp-group` element.

### 128.6.6 Compilation

A Web Runtime compiles a JSP page into a Servlet, either during the deployment phase, or at the time of request processing, and dispatches the request to an instance of such a dynamically created class. Often times, the compilation task is delegated to a separate JSP compiler that will be responsible for identifying the necessary tag libraries, and generating the corresponding Servlet. The container then proceeds to load the dynamically generated class, creates an instance and dispatches the servlet request to that instance.

Supporting in-line compilation of a JSP inside a bundle will require that the Web Runtime maintains a private area where it can store such compiled classes. The Web Runtime can leverage its private bundle storage area. The Web Runtime can construct a special class loader to load generated JSP classes such that classes from the bundle class path are visible to newly compiled JSP classes.

The JSP specification does not describe how JSP pages are dynamically compiled or reloaded. Various Web Runtime implementations handle the aspects in proprietary ways. This specification does not bring forward any explicit requirements for supporting dynamic aspects of JSP pages.

## 128.7 Security

The security aspects of this specification are defined by the [3] *Servlet 2.5 specification*.

## 128.8 References

[1] *Java Enterprise Edition Release 5*

- Java 1.5.0 Packages. <http://www.oracle.com/technetwork/java/javaee/tech/javaee5-jsp-135162.html>
- [2] *Java EE Web Applications*  
<http://www.oracle.com/technetwork/java/javaee/tech/webapps-138511.html>
- [3] *Servlet 2.5 specification*  
<http://jcp.org/aboutJava/communityprocess/mrel/jsr154/index.html>
- [4] *JSP 2.1 specification*  
<http://jcp.org/aboutJava/communityprocess/final/jsr245/index.html>
- [5] *PAX Web Extender*  
<http://team.ops4j.org/wiki/display/paxweb/Pax+Web>
- [6] *Uniform Resource Locators, RFC 1738*  
<http://www.ietf.org/rfc/rfc1738.txt>
- [7] *JSR 250 Common Annotations for the Java Platform*  
<http://jcp.org/aboutJava/communityprocess/pfd/jsr250/index.html>



# 130 Coordinator Service Specification

## Version 1.0

### 130.1 Introduction

The OSGi programming model is based on the collaboration of standard and custom components. In such a model there is no central authority that has global knowledge of the complete application. Though this lack of authority can significantly increase reusability (and robustness) there are times when the activities of the collaborators must be coordinated. For example, a service that is repeatedly called in a task could optimize performance by caching intermediate results until it *knew* the task was ended.

To know when a task involving multiple collaborators has ended is the primary purpose of the Coordinator service specification. The Coordinator service provides a rendezvous for an initiator to create a Coordination where collaborators can decide to participate. When the Coordination has ended, all participants are informed.

This Coordinator service provides an explicit Coordination model, the Coordination is explicitly passed as a parameter, and an implicit model where the Coordination is associated with the current thread. Implicit Coordinations can be nested.

Coordinators share the coordination aspects of the resource model of transactions. However, the model is much lighter-weight because it does not support any of the ACID properties.

#### 130.1.1 Essentials

- *Coordination* - Provide a solution to allow multiple collaborators to coordinate the outcome of a task initiated by an initiator.
- *Initiator* - An initiator must be able to initiate a coordination and control the final outcome.
- *Participants* - Participants in the task must be informed when the coordination has ended or failed as well as being able to terminate the Coordination.
- *Time-out* - A Coordination should fail after a given time-out.
- *Blocking* - Provide support for blocking and serializing access to Participants.
- *Nesting* - It must be possible to nest Coordinations.
- *Per Thread Model* - Provide a per-thread current Coordination model.
- *Variables* - Provide a variable space per Coordination

#### 130.1.2 Entities

- *Coordinator* - A service that can create and enumerate Coordinations.
- *Coordination* - Represents the ongoing Coordination.
- *Initiator* - The party that initiates a Coordination.
- *Participant* - A party that wants to be informed of the outcome of a Coordination.
- *Collaborator* - Either a participant or initiator.

Figure 130.1

Class and Service overview

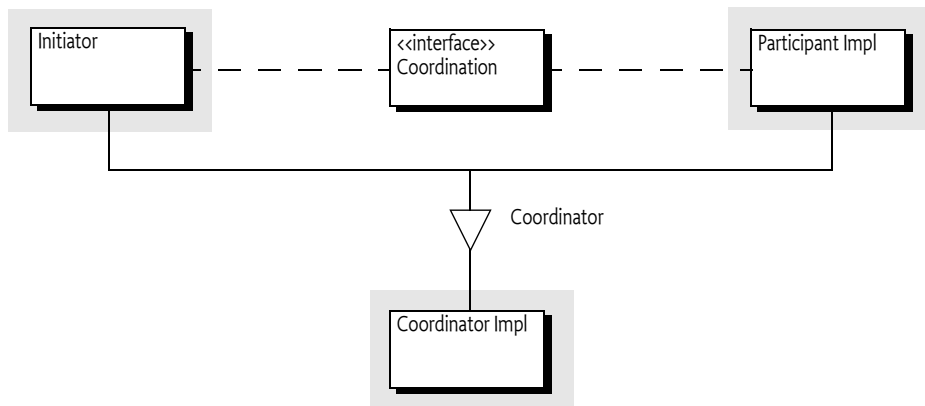

## 130.2 Usage

This section is an introduction in the usage of the Coordinator service. It is not the formal specification, the normative part starts at *Coordinator Service* on page 871. This section leaves out some of the details for clarity.

### 130.2.1 Synopsis

The Coordinator service provides a mechanism for multiple parties to *collaborate* on a common task without a priori knowledge of who will collaborate in that task. A collaborator can participate by adding a *Participant* to the *Coordination*. The *Coordination* will notify the *Participants* when the coordination is *ended* or when it is *failed*.

Each *Coordination* has an *initiator* that creates the *Coordination* object through the *Coordinator* service. The initiator can then push this object on a thread-local stack to make it an implicit *Coordination* or it can pass this object around as a parameter for *explicit* *Coordinations*. Collaborators can then use the *current* *Coordination* on the stack or get it from a parameter. Whenever a bundle wants to participate in the *Coordination* it adds itself to the *Coordination* as a participant. If necessary, a collaborator can initiate a new *Coordination*, which could be a nested *Coordination* for implicit *Coordinations*.

A *Coordination* must be *terminated*. Termination is either a normal end when the initiator calls the end method or it is failed when the fail method is called. A *Coordination* can be failed by any of the collaborators. A *Coordination* can also fail independently due to a *time-out* or when the initiator releases its *Coordinator* service. All participants in the *Coordination* are informed in reverse participation order about the outcome in a callback for ended or failed *Coordinations*.

A typical action diagram with a successful outcome is depicted in Figure 130.2.

Figure 130.2 Action Diagram Implicit Coordination

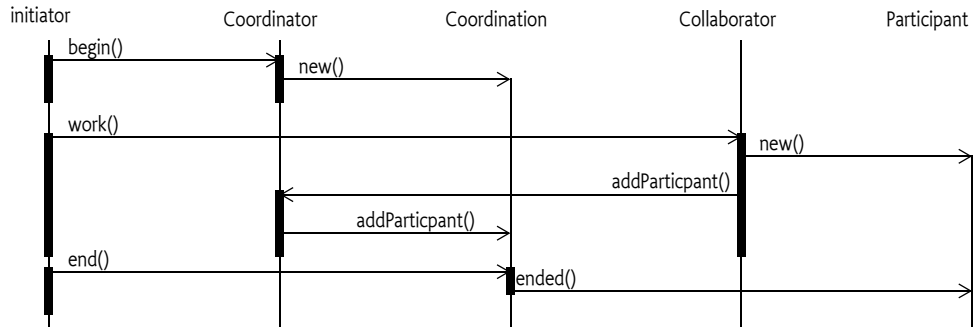

### 130.2.2 Explicit Coordination

The general pattern for an initiator is to create a Coordination through the Coordinator service, perform the work in a try block, catch any exceptions and fail the Coordination in the catch block, and then ensure ending the Coordination in the finally block. The finally block can cause an exception. This is demonstrated in the following example:

```

Coordination c = coordinator.create("com.example.work", 0);
try {
    doWork(c);
} catch( Exception e ) {
    c.fail(e);
} finally {
    c.end();
}
  
```

This deceptively small template is quite robust:

- If the `doWork` method throws an Exception then the template fails with a Coordination Exception because it is failed in the try block.
- Any exceptions thrown in the try block are automatically causing the Coordination to fail.
- The Coordination is always terminated and removed from the stack due to the finally block.
- All failure paths, Coordinations that are failed by any of the collaborators, time-outs, or other problems are handled by the `end` method in the finally block. It will throw a **FAILED** or **PARTIALLY\_ENDED** Coordination Exception for any of the failures.

The different failure paths and their handling is pictured in Figure 130.3.

Figure 130.3

Flow through the Coordination template

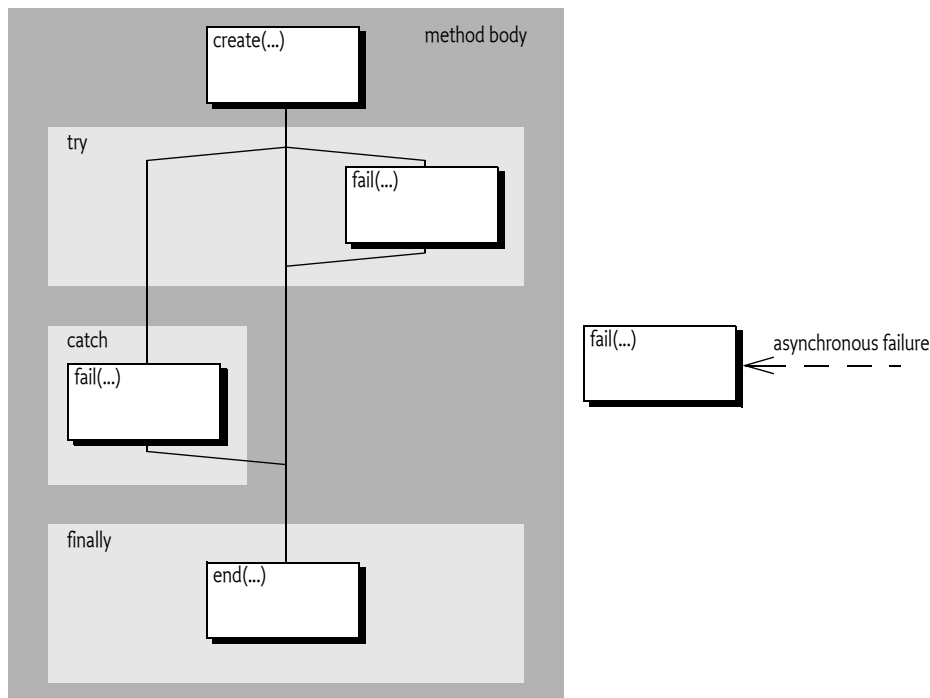

The example shows an explicit Coordination because the create method is used, implicit Coordinations are used in *Implicit Coordinations* on page 865. The parameters of the create method are the name of the Coordination and its time-out. The name is used for informational purposes as well as security. For security reasons, the name must follow the same syntax as the Bundle Symbolic Name. In a secure environment the name can be used to limit Coordinations to a limited set of bundles. For example, a set of bundles signed by a specific signer can use names like `com.acme.*` that are denied to all other bundles.

The zero time-out specifies that the Coordination will not have a time-out. Otherwise it must be a positive long, indicating the number of milliseconds the Coordination may take. However, implementations should have a configurable time-out to ensure that the system remains alive.

In the `doWork` method the real work is done in conjunction with the collaborators. Explicit Coordinations can be passed to other threads if needed. Collaborators can decide to add participants whenever they require a notification when the Coordination has been terminated. For example, the following code could be called from the `doWork` method:

```

void foo(Coordination c) {
    doPrepare();
    c.addParticipant(this);
}
  
```

This method does the preparation work but does not finalize it so that next time it can use some intermediate results. For example, the prepare method could cache a connection to a database that should be reused during the Coordination. The collaborator can assume that it will be called back on either the failed or ended method. These methods could look like:

```

public void ended(Coordination c) { doFinish(); }
public void failed(Coordination c) { doFailed(); }
  
```

The Coordinator provides the guarantee that this code will always call the `doFinish` method when the Coordination succeeds and `doFailed` method when it failed.

The Participant must be aware that the `ended(Coordination)` and `failed(Coordination)` methods can be called on any thread.

If the `doWork` method throws an exception it will end up in the catch block of the initiator. The catch block will then fail the Coordination by calling the `fail` method with the given exception. If the Coordination was already terminated because something else already had failed it then the method call is ignored, only the first fail is used, later fails are ignored.

In all cases, the finally block is executed last. The finally block ends the Coordination. If this coordination was failed then it will throw a Coordination Exception detailing the reason of the failure. Otherwise it will terminate it and notify all the participants.

The Coordination Exception is a Runtime Exception making it unnecessary to declare it.

### 130.2.3 Multi Threading

Explicit Coordinations allow the Coordination objects to be passed to many different collaborators who can perform the work on different threads. Each collaborator can fail the Coordination at any moment in time or the time-out can occur on yet another thread. Participants must therefore be aware that the callbacks `ended` and `failed` can happen on any thread. The following example shows a typical case where a task is parallelized. If any thread fails the Coordination, all other threads could be notified before they're finished.

```
Executor executor = ...
final CountdownLatch latch = new CountdownLatch(10);
final Coordination c = coordinator.create("parallel", 0);
for ( int i=0; i<10; i++) {
    executor.execute(
        new Runnable() {
            public void run() { baz(c); latch.countDown(); }
        });
}
latch.await();
c.end();
```

The Coordination object is thread safe so it can be freely passed around.

### 130.2.4 Implicit Coordinations

An explicit Coordination requires that the Coordination is passed as a parameter to the `doWork` method. The Coordinator also supports *implicit* Coordinations. With implicit Coordinations the Coordinator maintains a thread local stack of Coordinations where the top of this stack is the *current* Coordination for that thread. The usage of the implicit Coordination is almost identical to the explicit Coordinations except that all the work occurs on a single thread. The control flow is almost identical to explicit Coordinations:

```
Coordination c = coordinator.begin("com.example.work", 0);
try {
    doWork();
} catch( Exception e ) {
    c.fail(e);
} finally {
    c.end();
}
```

See also Figure 130.3. However, in this case the finally block with the call to the end method is even more important. With an implicit Coordination the Coordination is put on a thread local stack in the begin method and must therefore be popped when the Coordination is finished. The finally block ensures therefore the proper cleanup of this thread local stack.

The difference between implicit and explicit Coordinations is that the implicit Coordination is not passed as a parameter, instead, collaborators use the current Coordination. With implicit Coordinations all method invocations in a thread can always access the current Coordination, even if they have many intermediates on the stack. The implicit model allows a collaborator many levels down the stack to detect a current Coordination and register itself without the need to modify all intermediate methods to contain a Coordination parameter. The explicit model has the advantage of explicitness but requires all APIs to be modified to hold the parameter. This model does not support passing the parameter through layers that are not aware of the Coordination. For example, OSGi services in general do not have a Coordination parameter in their methods making the use of explicit Coordinations impossible.

Collaborators can act differently in the presence of a current Coordination. For example, a collaborator can optimize its work flow depending on the presence of a current Coordination.

```
Coordinator coordinator = ...
void foo() {
    doPrepare();
    if ( !coordinator.addParticipant(this))
        doFinish();
}
```

The Coordinator service has an addParticipant method that makes working with the current Coordination simple. If there is a current Coordination then the Coordinator service will add the participant and return true, otherwise it returns false. It is therefore easy to react differently in the presence of a current Coordination. In the previous example, the doFinish method will be called immediately if there was no current Coordination, otherwise it is delayed until the Coordination fails or succeeds. The participant callbacks look the same as in the previous section:

```
public void ended(Coordination c) { doFinish(); }
public void failed(Coordination c) { doFailed(); }
```

Though the code looks very similar for the implicit and explicit Coordinations there are some additional rules for implicit Coordinations.

The end method must be called on the same thread as the begin method, trying to end it on another thread results in a [WRONG\\_THREAD](#) Coordination Exception being thrown.

Even though the end method must be called on the initiating thread, the callbacks to the Participants can be done on any thread as the specification allows the Coordinator to use multiple threads for all callbacks.

## 130.2.5 Partial Ending

The Coordination is a best effort mechanism to coordinate, not a transaction model with integrity guarantees. This means that users of the Coordinator service must understand that there are cases where a Coordination ends in limbo. This happens when one of the Participants throws an Exception in the ended callback. This is similar to a transactional resource manager failing to commit in a 2-phase commit after it has voted yes in the prepare phase; a problem that is the cause of much of the complexity of a transaction manager. The Coordinator is limited to use cases that do not require full ACID properties and can therefore be much simpler. However, users of the Coordinator service must be aware of this limitation.

If a Participant throws an exception in the ended method, the end method that terminated the Coordination must throw a [PARTIALLY\\_ENDED](#) Coordination Exception. It is then up to the initiator to

correct the situations. In most cases, this means allowing the exception to be re-thrown and handle the failure at the top level. Handling in those cases usually implies logging and continuing.

The following code shows how the `PARTIALLY_ENDED` case can be handled more explicitly.

```
Coordination c = coordinator.begin("work",0);
try {
    doWork();
} catch( Exception e ) {
    c.fail(e);
} finally {
    try {
        c.end();
    } catch( CoordinationException e ) {
        if ( e.getType() == CoordinationException.PARTIALLY_ENDED ) {
            // limbo!
            ...
        }
    }
}
```

### 130.2.6

#### Locking

To participate in a Coordination and receive callbacks a collaborator must add a Participant object to the Coordination. The `addParticipant(Participant)` method blocks if the given Participant object is already used in another Coordination. This blocking facility can be used to implement a number of simple locking schemes that can simplify maintaining state in a concurrent environment.

Using the Participant object as the key for the lock makes it simple to do course grained locking. For example, a service implementation could use the service object as a lock, effectively serializing access to this service when it is used in a Coordination. Coarse grained locking allows all the state to be maintained in the coarse object and not having to worry about multiplexing simultaneous requests. The following code uses the coarse locking pattern because the collaborator implements the Participant interface itself:

```
public class Collaborator implements Participant{
    public void doWork(Coordination coordination ) {
        ...
        coordination.addParticipant(this);
    }

    public void ended(Coordination c) { ... }
    public void failed(Coordination c) { ... }
}
```

The simplicity of the coarse grained locking is at the expense of lower performance because tasks are serialized even if it would have no contention. Locks can therefore also be made more fine grained, allowing more concurrency. In the extreme case, creating a new object for each participation makes it possible to never lock. For example, the following code never locks because it always creates a new object for the Participant:

```
public void doWork(Coordination coordination){
    final State state = ...
    coordination.addParticipant(
        new Participant() {
            public void ended(Coordination c) { state ... }
            public void failed(Coordination c) { state ... }
        }
    );
}
```

```
    } ); }
```

### 130.2.7 Failing

Any collaborator can fail an ongoing Coordination by calling the `fail(Throwable)` method, the Throwable parameter must not be null. When the Coordination has already terminated then this is a no-op. The Coordinator service has a convenience method that fails the current Coordination if present. The fail methods return a boolean that is true when the method call causes the termination of the Coordination, in all other cases it is false.

Failing a Coordination will immediately perform the callbacks and reject any additional Participants by throwing an `ALREADY_ENDED` Coordination Exception. The asynchronous nature of the fail method implies that it is possible to have been called even before the `addParticipant(Participant)` method has returned. Anybody that has the Coordination object can check the failed state with the `getFailure()` method.

In general, the best and most robust strategy to handle failures is to throw an Exception from the collaborator, allowing the initiator to catch the exception and properly fail the Coordination.

### 130.2.8 Time-out

The time-out is specified in the Coordinator `create(String,long)` or `begin(String,long)` methods. A time-out of zero is indefinite, otherwise the time-out specifies the number of milliseconds the Coordination can take to terminate. A given time-out can be extended with the `extendTimeout(long)` method. This method will add an additional time-out to the existing deadline if a prior deadline was set. For example, the following code extends the time-out with 5 seconds whenever a message must be sent to a remote address:

```
Object sendMessage(Message m) {
    Coordination c = coordinator.peek();
    Address a = m.getDestination();
    if ( c != null && a.isRemote() ) {
        c.extendTimeout(5000);
    }
    return sendMessage0(m);
}
```

Applications should not rely on the exact time-out of the Coordination and only use it as a safety function against deadlocks and hanging collaborators.

### 130.2.9 Joining

When a Coordination is terminated it is not yet completely finished, the callback to the Participants happens after the atomic termination. In certain cases it is necessary to ensure that a method does not progress until all the participants have been notified. It is therefore possible to wait for the Coordination to completely finish with the `join(long)` method. This method can have a time-out. For example:

```
void collaborate( final Coordination c ) {
    doWork();
    Thread t = new Thread() {
        public void run(){
            try {
                c.join(0);
                ... // really terminated here, all participants called back
            } catch( Exception e) { ... }
        }
    };
};
```



```

    t.start();
}

```

### 130.2.10 Variables

A Participant is likely to have to maintain state that is particular for the collaboration. This state is usually needed in the ended method to properly finalize the work. In general, the best place to store this state is in the Participant object itself, inner classes and final variables are a good technique for storing the state. However, the state can also be stored in a *Coordination variable*. Each Coordination has a private set of variables that can be obtained with the `getVariables()` method. The resulting map takes a class as the key and returns an Object. The map is not synchronized, any changes to the map must be synchronized on the returned Map object to ensure the visibility of the changes to other threads. The class used for the key is not related to the returned type, it is a Class object to provide a convenient namespace.

The following example shows how the state can be stored with variables.

```

public void doWork(Coordination coordination){
    Map<Class<?>,Object> map = coordination.getVariables();
    synchronized(map) {
        State state = (State) map.get( SharedWorker.class );
        if ( state == null ) {
            state = new State(this);
            map.put( state );
            ... do initial work
        }
    }
    ... do other work
    coordination.addParticipant( this );
}
public void ended(Coordination c) {
    Map<Class<?>,Object> map = coordination.getVariables();
    synchronized(map) {
        State state = (State) map.get( SharedWorker.class );
        .. finalize
    }
}
public void failed(Coordination c) {
    Map<Class<?>,Object> map = coordination.getVariables();
    synchronized(map) {
        State state = (State) map.get( SharedWorker.class );
        .. finalize
    }
}
}

```

### 130.2.11 Optimizing Example

For example, a web based system has a charge service:

```

public interface Charge {
    void charge( String reason, int amount );
}

```

This service is used throughout the system for charging the tasks the system performs. Each servlet request can actually create multiple Charge Data Records (CDR). For this reason, a Coordination is started before the page is constructed. Each part of the page that has an associated cost must create a CDR. There are the following issues at stake:

- Charging should not take place when failing, and
- Performance can be optimized to only persist the CDRs once, and
- The user must be passed to the Charge service.

To begin with the request code:

```
public void doGet(HttpServletRequest rq, HttpServletResponse rsp) {
    Coordination c = coordinator.begin("com.acme.request", 30000);
    try {
        Principal p = rq.getUserPrincipal();
        Map<Class<?>,Object> map = c.getVariables();
        map.put( Principal.class, p );
        buildPage(rq,rsp);
    } catch( Exception e ) { c.fail(e); }
    finally { c.end(); }
}
```

Each method that has a charge will call the Charge service. The following code shows an implementation of this Charge service.

```
public class ChargeImpl implements Charge,Participant {
    final List<CDR> records = new ArrayList<CDR>();

    public void charge( String reason, int amount ) {
        Coordination c = coordinator.peek();
        if ( c == null ) {
            save( Arrays.asList( new CDR(null, reason, amount)));
        } else {
            Principal p = getPrincipal(c);
            records.add( new CDR(p, reason, amount ) );
            c.addParticipant( this );
        }
    }

    Principal getPrincipal(Coordination c) {
        if ( c == null )
            return null;

        Map<Class<?>,Object> map = c.getVariables();
        synchronized(map) {
            Principal p = (Principal) map.get( Principal.class );
            return p != null ? p : getPrincipal(c.getEnclosingCoordination());
        }
    }

    public void ended(Coordination c) {
        save(records);
        records.clear();
    }
    public void failed(Coordination c) {
        records.clear();
    }

    void save(List<CDR> records) { ... }
}
```

### 130.2.12 Security Example

The Coordination Permission is a filter based permission that is asserted for many of the methods in the API, the bundle that is checked is always the bundle that created the corresponding Coordination. For example:

```
ALLOW {
    [ BundleSignerCondition "cn=ACME" ]
    ( CoordinationPermission "(signer=cn=ACME)" "*" )
}
```

This example allows bundles signed by ACME to perform all Coordination actions on Coordinations created by bundles signed by ACME.

The filter can also assert the name of the Coordination:

```
coordination.name
```

It is therefore possible to create a name based protection scheme. By denying all bundles except a select group through the use of a name prefix, the use of Coordinations can be restricted to this select group:

```
DENY {
    [ BundleSignerCondition "cn=ACME" "!" ]
    ( CoordinationPermission "(coordination.name=com.acme.*) "*" )
}
ALLOW {
    ( CoordinationPermission "(coordination.name=*)" "*" )
}
```

If a bundle is not signed by ACME it will be denied the use of Coordination names starting with `com.acme.` though it will be allowed to use any other name. This effectively enables only bundles signed by ACME to create Coordinations with this name prefix.

## 130.3 Coordinator Service

The Coordinator service is the entry point for the Coordination. It provides the following functions:

- Coordination creation
- Life cycle management of a Coordination
- Thread based Coordinations
- Introspection

### 130.3.1 Coordination Creation

A Coordination object is created by an *initiator*. An initiator can create a Coordination object with the Coordinator `create(String,long)` or `begin(String,long)` method. Each Coordination when created gets a positive long identity that is available with `getId()`. Ids are a unique identifier for a specific Coordinator service. The id is always increasing, that is, a Coordination with a higher id is created later.

The create methods specify the name of the Coordination. This name is a security concept, see *Security* on page 876, as well as used for debugging. The coordination name must therefore conform to the same syntax as a bundle symbolic name:

```
coordination-name ::= symbolic-name // see OSGi Core Release 6
```

Passing a name that does not conform to this syntax must throw an `Illegal Argument Exception`. There are no constraints on duplicates, multiple different Coordinations can use the same name. The name of the Coordination is available with the `getName()` method.

### 130.3.2 Adding Participants

The Coordination object can be passed to *collaborators* as a parameter in a method call. Some of these collaborators might be interested in *participating* in the given Coordination, they can achieve this by adding a Participant object to the Coordination.

A Participant is a collaborator that requires a callback after the Coordination has been terminated, either when it ended or when it failed. To participate, it must add a Participant object to a Coordination with the `addParticipant(Participant)` method on Coordination. This method throws an `ALREADY_ENDED` or `FAILED` Coordination Exception when the Coordination has been terminated.

When a Participant is:

- *Not in any Coordination* - Add it to the given Coordination and return.
- *In target Coordination* - Ignore, participant is already present. A Participant can participate in the same Coordination multiple times by calling `addParticipant(Participant)` but will only be called back once when the Coordination is terminated. Its order must be defined by the first addition.
- *In another Coordination* - Lock until after the other Coordination has notified all the Participants. Implementations can detect deadlocks in certain cases and throw a Coordination Exception if a dead lock exist, otherwise the deadlock is solved when the Coordination times out.

Verifying if a Participant object is already in another Coordination must use identity and not equality.

### 130.3.3 Active

A Coordination is active until it is *terminated*. A Coordination can terminate because it is *ended*, or it is *failed*. The following methods cause a termination:

- `end()` - A normal end. All participants that were added before the end call are called back on their `ended(Coordination)` method.
- `fail(Throwable)` - The Coordination has failed, this will call back the `failed(Coordination)` method on the participants. This method can be called by the Coordinator, the initiator, or any of the collaborators. There are a number of failures that are built in to the Coordinator. These failures use singleton Exception instances defined in the Coordination interface:
  - `TIMEOUT` - If the Coordination times out the Coordination is failed with the `TIMEOUT` exception instance in Coordination.
  - `RELEASED` - If the Coordinator that created the Coordination was unget, all Coordinations created by it will fail with the `RELEASED` exception.

The state diagram for the Coordination is pictured in Figure 130.4.

Figure 130.4

Coordination state diagram

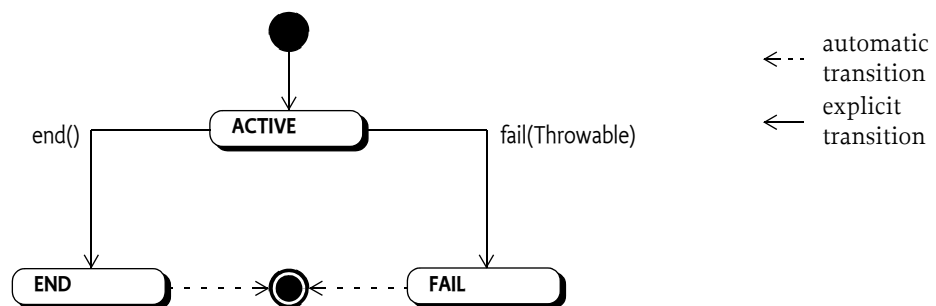

### 130.3.4 Explicit and Implicit Models

The Coordinator supports two very different models of usage: *explicit* and *implicit*. The explicit model is when a Coordination is created and passed around as a parameter. The second model is the implicit model where the Coordinator maintains a thread local stack of Coordinations. Any collaborator can then decide to use the top of the stack as the *current* Coordination. The `peek()` method provides access to the current Coordination.

The `begin(String,long)` method creates a new Coordination and pushes this on the stack, beginning an implicit Coordination. This is identical to:

```
coordinator.create("work",0).push();
```

Once a Coordination is pushed on a stack it is from that moment on associated with the current thread. A Coordination can only be pushed once, the `ALREADY_PUSHED` Coordination Exception must be thrown when the Coordination is already associated with one of the thread local stacks maintained by the Coordinator service.

The Coordination is removed from the stack in the `end()` method. The `end()` method must not only terminate itself but it must also terminate all nested Coordinations.

The current Coordination can also be explicitly removed with the Coordinator `pop()` method.

A Coordination that is pushed on a thread local stack returns the associated thread on the `get-Thread()` method. This method returns null for Coordinations not on any stack, that is, explicit Coordinations.

### 130.3.5 Termination

Both the `end()` and `fail(Throwable)` methods terminate the Coordination if it was not already terminated. Termination is atomic, only the end or the fail method can terminate the Coordination. Though this happens on different threads, a Coordination can never both end and fail from any perspective. That is, if a fail races with end then only one of them can win and the other provides the feedback that the Coordination was already terminated.

Terminating a Coordination has the following effects:

- It is atomic, it can only happen once in a Coordination
- It freezes the set of participants, no more participants can be added

### 130.3.6 Ending

The `end()` method should always be called at the end of a Coordination to ensure proper termination, notification, and cleanup. The end method throws a `FAILED` or `PARTIALLY_ENDED` Coordination Exception if the Coordination was failed before.

If the Coordination had already been ended before then this is a programming error and an `ALREADY_ENDED` Configuration Exception is thrown. The `end()` method should never be called twice on the same Coordination.

If the termination succeeds then the participants must be notified by calling the `ended(Coordination)` method on each Participant that had been successfully added to the Coordination. This callback can take place on any thread but must be in reverse order of adding. That is, the last added Participant is called back first.

Participants must never make any assumptions about the current Coordination in the callback. The Coordination it was added to is therefore given as an explicit parameter in the `ended(Coordination)` method.

If a Participant throws an Exception then this must not prevent the calling of the remaining participants. The Exception should be logged. If a Participant has thrown an Exception then the `end()`

method must throw a `PARTIALLY_ENDED` Coordination Exception after the last Participant has returned from its callback, otherwise the method returns normally. Participants should normally not throw Exceptions in their callbacks.

If the Coordination is implicit (it is pushed on a stack) then the Coordination must be removed from its stack after the participants have been called back. This requires that the ending thread is the same as the thread of the Coordination. The end thread is the thread of the `end()` method call. If the Coordination's thread is not the same as the ending thread then a `WRONG_THREAD` Coordination Exception is thrown.

If the ending Coordination is on the stack but it is not the current Coordination then each nested Coordination must be ended before the current Coordination, see *Nesting Implicit Coordinations* on page 874 for more information.

The `fail(Throwable)` method must not remove the current Coordination, it must remain on the stack. The initiator must always call the `end()` method. Always calling `end()` in a finally block is therefore paramount.

### 130.3.7 Failing, TIMEOUT, ORPHANED, and RELEASED

*Failing* can happen asynchronously during the time a Coordination is active. A Coordination is failed by calling `fail(Throwable)`. The `Throwable` argument must not be null, it is the cause of the failure.

Failing a Coordination must first terminate it. If the Coordination was already terminated the `fail(Throwable)` method has no effect. Otherwise, it must callback all its added Participants on the `failed(Coordination)` callback method. Exceptions thrown from this method should be logged and further ignored. The callback can occur on any thread, including the caller's.

Implicit Coordinations must not be popped from its stack in a fail nor is it necessary to call the fail method from any particular thread. The removal of the Coordination from the stack must happen in the end method.

There are two asynchronous events that can also fail the Coordination. If the Coordination times out, it will be treated as a `fail(TIMEOUT)` and if the Coordinator is ungoten with active Coordinations then each of those Coordinations must fail as if `fail(RELEASED)` is called.

A Coordination can also be *orphaned*. An orphaned Coordination has no longer any outside references. This means that the Coordination can no longer be ended or failed. Such Coordinations must fail with an `ORPHANED` Exception.

### 130.3.8 Nesting Implicit Coordinations

Implicit Coordinations can be nested. For this reason, the Coordinator maintains a thread local stack of Coordinations where the top, accessible with the `peek()` method, is the current Coordination. Each time a new Coordination is begun with the `begin(String,long)` method, the current Coordination is replaced with the newly created Coordination. When that Coordination is ended, the previous current Coordination is restored. Nesting is always on the same thread, implicit Coordinations are always associated with a single thread, available through its `getThread()` method. The end method must be called on the same thread as the `begin(String,long)` or last `push()` method.

Using the standard model for implicit Coordinations, where the initiator always ends the Coordination on the same thread as it begun, ensures that nesting is properly handled. However, in certain cases it is necessary to manipulate the stack or make implicit Coordinations explicit or vice versa. For this reason, it is possible to pop Coordinations from the stack with the `pop()` method. This method disassociates the Coordination from the current thread and restores the previous (if any) Coordination as the current Thread. A Coordination can then be made the current Coordination for a thread by calling the `push()` method. However, a Coordination can be pushed on the stack at most once. If a Coordination is pushed a second time, in any thread, the `ALREADY_PUSHED` Coordination Exception must be thrown.

The Coordination is removed from its stack when the `end()` method is called. It is therefore highly recommended to always end a Coordination in the nesting order. However, it is possible that a Coordination is ended that is not the current Coordination, it has nested Coordinations that were not properly ended. In that case all nested Coordinations must be ended in reverse creation order, that is, the current Coordination first, by calling the end method on it.

If any Coordination fails to end properly (including `PARTIALLY_ENDED`) then the remaining Coordinations on the stack must fail and chain the exceptions. In pseudo code:

```
while (coordinator.peek() != this) {
  try {
    coordinator.peek().end();
  } catch (CoordinationException e) {
    coordinator.peek().fail(e);
  }
}
```

### 130.3.9 Time-outs

When a Coordination is created it will receive a time-out. A time-out is a positive value or zero. A zero value indicates that the Coordination should have no time-out. This does not imply that a Coordination will never time-out, implementations are allowed to be configured with a limit to the maximum active time for a Coordination.

Collaborators can extend the time out with the `extendTimeout(long)` method. If no time-out was set (0), this method will be ignored. Otherwise the given amount (which must be positive) is added to the existing deadline. A Coordinator implementation can fail the Coordination earlier, however, when configured to do so.

If a Coordination is timed out, the Coordination is failed with a `fail(TIMEOUT)` method call from an unspecified thread, see *Failing, TIMEOUT, ORPHANED, and RELEASED* on page 874.

### 130.3.10 Released

The Coordination's life cycle is bound to the Coordinator service that created it. If the initiator's bundle ungets this service then the Coordinator must fail all the Coordinations created by this Coordinator by calling the `fail(RELEASED)` method.

Participants from bundles that are stopped are not taken into account. This means that it is possible that a participant is called while its bundle is stopped. Stopped Participants should fail any Coordinations that they participate in.

### 130.3.11 Coordinator Convenience Methods

The Coordinator contains a number of convenience methods that can be used by collaborators to interact with the current Coordination.

- `begin(String,long)` - Is logically the same as `create(String,long).push()`.
- `addParticipant(Participant)` - This method makes it easy to react differently to the presence of a current implicit Coordination. If a current Coordination exists, the participant is added and `true` is returned (or an exception thrown if the Coordination is already terminated), otherwise `false` is returned.
- `fail(Throwable)` - If there is no current Coordination, this method returns `false`. Otherwise it returns the result of calling `fail(Throwable)` on the current Coordination. This method therefore only returns `true` when a current Coordination was actually terminated due to this call.

### 130.3.12 Administrative Access

The Coordination objects provide a number of methods that are used for administrating the Coordinations and the Coordinator.

- [getBundle\(\)](#) - Provide the bundle that created the Coordination. This bundle is the bundle belonging to the Bundle Context used to get the Coordinator service.
- [getFailure\(\)](#) - The Exception that caused this Coordination to fail or null. There are two fixed exception instances for a time out ( [TIMEOUT](#) ), when the Coordination is orphaned ( [ORPHANED](#) ), and when the Coordinator service is released ( [RELEASED](#) ).
- [getId\(\)](#) - The Coordination's id.
- [getName\(\)](#) - The name of the Coordination.
- [getParticipants\(\)](#) - The current list of participants. This is a mutable snapshot of the added participants. Changing the snapshot has no effect on the Coordination.
- [getThread\(\)](#) - Answer the thread associated with an implicit Coordination. If the Coordination is not implicit then the answer is null.
- [getEnclosingCoordination\(\)](#) - Return the enclosing Coordination.

And for the Coordinator:

- [getCoordination\(long\)](#) - Retrieve a Coordination by its id.
- [getCoordinations\(\)](#) - Get a list of active Coordinations

### 130.3.13 Summary

A Coordination can exist in three different states *ACTIVE*, *END*, and *FAIL*. During its life it will transition from *ACTIVE* to either *END* or *FAIL*. The entry (when the state is entered) and exit (when the state is left) actions when this transition takes place and the effect on the different methods are summarized in the following table.

Table 130.1

States and transitions

State/Method entry action	ACTIVE	END	FAIL
		Notify all the participants by calling the <a href="#">ended(Coordination)</a> method.	Notify all the participants by calling the <a href="#">failed(Coordination)</a> method.
exit action <a href="#">end()</a>	Terminate -> END.	throws <a href="#">ALREADY_ENDED</a>	throws <a href="#">FAILED</a>
<a href="#">fail(Throwable)</a>	Can throw <a href="#">PARTIALLY_ENDED</a> -> FAIL, return true.	return false.	return false.

## 130.4 Security

This specification provides a Coordination Permission. This permission can enforce the name of the coordination as well as assert the properties of the initiating bundle, like for example the signer or bundle symbolic name. The permission therefore uses a filter as name, as defined in the filter based permissions section in *OSGi Core Release 6*, see *OSGi Core Release 6*. There is one additional parameter for the filter:

coordination.name

The value is the given name of the Coordination. Restricting the name of a Coordination allows the deployer to limit the use of this name to a restricted set of bundles.

The following actions are defined:

- [INITIATE](#) - Required to initiate and control a Coordination.
- [PARTICIPATE](#) - Required to participate in a Coordination.



- **ADMIN** - Required to administrate a Coordinator.

The target bundle of the Coordination Permission is the initiator's bundle. This is the bundle that got the Coordinator service to create the Coordination. An initiator must therefore have permission to create Coordinations for itself.

There are two constructors available:

- `CoordinationPermission(String,String)` - The constructor for the granted permission. It is given a filter expression and the actions that the permission applies to.
- `CoordinationPermission(String,Bundle,String)` - The constructor for the requested permission. It is given the name of the permission, the bundle that created the corresponding coordination, and the requested actions.

## 130.5 org.osgi.service.coordinator

Coordinator Package Version 1.0.

Bundles wishing to use this package must list the package in the Import-Package header of the bundle's manifest. This package has two types of users: the consumers that use the API in this package and the providers that implement the API in this package.

Example import for consumers using the API in this package:

```
Import-Package: org.osgi.service.coordinator; version="[1.0,2.0)"
```

Example import for providers implementing the API in this package:

```
Import-Package: org.osgi.service.coordinator; version="[1.0,1.1)"
```

### 130.5.1 Summary

- **Coordination** - A Coordination object is used to coordinate a number of independent Participants.
- **CoordinationException** - Unchecked exception which may be thrown by a Coordinator implementation.
- **CoordinationPermission** - A bundle's authority to create or use a Coordination.
- **Coordinator** - A Coordinator service coordinates activities between different parties.
- **Participant** - A Participant participates in a Coordination.

### 130.5.2 public interface Coordination

A Coordination object is used to coordinate a number of independent Participants.

Once a Coordination is created, it can be used to add Participant objects. When the Coordination is ended, the participants are notified. A Coordination can also fail for various reasons. When this occurs, the participants are notified of the failure.

A Coordination must be in one of two states, either **ACTIVE** or **TERMINATED**. The transition between **ACTIVE** and **TERMINATED** must be atomic, ensuring that a Participant can be guaranteed of either receiving an exception when adding itself to a Coordination or of receiving notification the Coordination has terminated.

A Coordination object is thread safe and can be passed as a parameter to other parties regardless of the threads these parties use.

The following example code shows how a Coordination should be used.

```
void foo() {
```

```

    Coordination c = coordinator.create("work", 0);
    try {
        doWork(c);
    }
    catch (Exception e) {
        c.fail(e);
    }
    finally {
        c.end();
    }
}

```

*Concurrency* Thread-safe

*Provider Type* Consumers of this API must not implement this type

**130.5.2.1**      **public static final Exception ORPHANED**

A singleton exception that will be the failure cause when a Coordination has been orphaned.

**130.5.2.2**      **public static final Exception RELEASED**

A singleton exception that will be the failure cause when the Coordinations created by a bundle are terminated because the bundle released the Coordinator service.

**130.5.2.3**      **public static final Exception TIMEOUT**

A singleton exception that will be the failure cause when a Coordination times out.

**130.5.2.4**      **public void addParticipant(Participant participant)**

*participant* The Participant to register with this Coordination. The participant must not be null.

- Register a Participant with this Coordination.

Once a Participant is registered with this Coordination, it is guaranteed to receive a notification for either normal or failure termination when this Coordination is terminated.

Participants are registered using their object identity. Once a Participant is registered with this Coordination, subsequent attempts to register the Participant again with this Coordination are ignored and the Participant is only notified once when this Coordination is terminated.

A Participant can only be registered with a single active Coordination at a time. If a Participant is already registered with an active Coordination, attempts to register the Participation with another active Coordination will block until the Coordination the Participant is registered with terminates. Notice that in edge cases the notification to the Participant that this Coordination has terminated can happen before this method returns.

Attempting to register a Participant with a terminated Coordination will result in a CoordinationException being thrown.

The ordering of notifying Participants must follow the reverse order in which the Participants were registered.

*Throws* CoordinationException– If the Participant could not be registered with this Coordination. This exception should normally not be caught by the caller but allowed to be caught by the initiator of this Coordination.

SecurityException– If the caller does not have CoordinationPermission[PARTICIPATE] for this Coordination.

**130.5.2.5**      **public void end()**

- Terminate this Coordination normally.

If this Coordination has been pushed on the thread local Coordination stack of another thread, this method does nothing except throw a CoordinationException of type CoordinationException.WRONG\_THREAD.

If this Coordination has been pushed on the thread local Coordination stack of this thread but is not the current Coordination, then the Coordinations on the thread local Coordination stack above this Coordination must be terminated and removed from the thread local Coordination stack before this Coordination is terminated. Each of these Coordinations, starting with the current Coordination, will be terminated normally. If the termination throws a CoordinationException, then the next Coordination on the thread local Coordination stack will be terminated as a failure with a failure cause of the thrown CoordinationException. At the end of this process, this Coordination will be the current Coordination and will have been terminated as a failure if any of the terminated Coordinations threw a CoordinationException.

If this Coordination is the current Coordination, then it will be removed from the thread local Coordination stack.

If this Coordination is already terminated, a CoordinationException is thrown. If this Coordination was terminated as a failure, the failure cause will be the cause of the thrown CoordinationException.

Otherwise, this Coordination is terminated normally and then all registered Participants are notified. Participants should finalize any work associated with this Coordination. The successful return of this method indicates that the Coordination has terminated normally and all registered Participants have been notified of the normal termination.

It is possible that one of the Participants throws an exception during notification. If this happens, this Coordination is considered to have partially failed and this method must throw a CoordinationException of type CoordinationException.PARTIALLY\_ENDED after all the registered Participants have been notified.

*Throws* CoordinationException– If this Coordination has failed, including timed out, or partially failed or this Coordination is on the thread local Coordination stack of another thread.

SecurityException– If the caller does not have CoordinationPermission[INITIATE] for this Coordination.

### 130.5.2.6 **public long extendTimeout(long timeMillis)**

*timeMillis* The time in milliseconds to extend the current timeout. If the initial timeout was specified as 0, no extension must take place. A zero must have no effect.

- Extend the time out of this Coordination.

Participants can call this method to extend the timeout of this Coordination with at least the specified time. This can be done by Participants when they know a task will take more than normal time.

This method will return the new deadline if an extension took place or the current deadline if, for whatever reason, no extension takes place. Note that if a maximum timeout is in effect, the deadline may not be extended by as much as was requested, if at all. If there is no deadline, zero is returned. Specifying a timeout extension of 0 will return the existing deadline.

*Returns* The new deadline in milliseconds. If the specified time is 0, the existing deadline is returned. If this Coordination was created with an initial timeout of 0, no timeout is set and 0 is returned.

*Throws* CoordinationException– If this Coordination is terminated.

IllegalArgumentException– If the specified time is negative.

SecurityException– If the caller does not have CoordinationPermission[PARTICIPATE] for this Coordination.

**130.5.2.7 public boolean fail(Throwable cause)**

*cause* The failure cause. The failure cause must not be null.

- Terminate this Coordination as a failure with the specified failure cause.

If this Coordination is already terminated, this method does nothing and returns false.

Otherwise, this Coordination is terminated as a failure with the specified failure cause and then all registered Participants are notified. Participants should discard any work associated with this Coordination. This method will return true.

If this Coordination has been pushed onto a thread local Coordination stack, this Coordination is not removed from the stack. The creator of this Coordination must still call end() on this Coordination to cause it to be removed from the thread local Coordination stack.

*Returns* true if this Coordination was active and was terminated by this method, otherwise false.

*Throws* SecurityException– If the caller does not have CoordinationPermission[PARTICIPATE] for this Coordination.

**130.5.2.8 public Bundle getBundle()**

- Returns the bundle that created this Coordination. This is the bundle that obtained the Coordinator service that was used to create this Coordination.

*Returns* The bundle that created this Coordination.

*Throws* SecurityException– If the caller does not have CoordinationPermission[ADMIN] for this Coordination.

**130.5.2.9 public Coordination getEnclosingCoordination()**

- Returns the Coordination enclosing this Coordination if this Coordination is on the thread local Coordination stack.

When a Coordination is pushed onto the thread local Coordination stack, the former current Coordination, if any, is the enclosing Coordination of this Coordination. When this Coordination is removed from the thread local Coordination stack, this Coordination no longer has an enclosing Coordination.

*Returns* The Coordination enclosing this Coordination if this Coordination is on the thread local Coordination stack or null if this Coordination is not on the thread local Coordination stack or has no enclosing Coordination.

*Throws* SecurityException– If the caller does not have CoordinationPermission[ADMIN] for this Coordination.

**130.5.2.10 public Throwable getFailure()**

- Returns the failure cause of this Coordination.

If this Coordination has failed, then this method will return the failure cause.

If this Coordination timed out, this method will return TIMEOUT as the failure cause. If this Coordination was active when the bundle that created it released the Coordinator service, this method will return RELEASED as the failure cause. If the Coordination was orphaned, this method will return ORPHANED as the failure cause.

*Returns* The failure cause of this Coordination or null if this Coordination has not terminated as a failure.

*Throws* SecurityException– If the caller does not have CoordinationPermission[INITIATE] for this Coordination.

**130.5.2.11 public long getId()**

- Returns the id assigned to this Coordination. The id is assigned by the Coordinator service which created this Coordination and is unique among all the Coordinations created by the Coordinator service and must not be reused as long as the Coordinator service remains registered. The id must be positive and monotonically increases for each Coordination created by the Coordinator service.

*Returns* The id assigned to this Coordination.

**130.5.2.12 public String getName()**

- Returns the name of this Coordination. The name is specified when this Coordination was created.

*Returns* The name of this Coordination.

**130.5.2.13 public List<Participant> getParticipants()**

- Returns a snapshot of the Participants registered with this Coordination.

*Returns* A snapshot of the Participants registered with this Coordination. If no Participants are registered with this Coordination, the returned list will be empty. The list is ordered in the order the Participants were registered. The returned list is the property of the caller and can be modified by the caller.

*Throws* `SecurityException`– If the caller does not have `CoordinationPermission[INITIATE]` for this Coordination.

**130.5.2.14 public Thread getThread()**

- Returns the thread in whose thread local Coordination stack this Coordination has been pushed.

*Returns* The thread in whose thread local Coordination stack this Coordination has been pushed or null if this Coordination is not in any thread local Coordination stack.

*Throws* `SecurityException`– If the caller does not have `CoordinationPermission[ADMIN]` for this Coordination.

**130.5.2.15 public Map<Class<?>,Object> getVariables()**

- Returns the variable map associated with this Coordination. Each Coordination has a map that can be used for communicating between different Participants. The key of the map is a class, allowing for private data to be stored in the map by using implementation classes or shared data by using shared interfaces. The returned map is not synchronized. Users of the map must synchronize on the Map object while making changes.

*Returns* The variable map associated with this Coordination.

*Throws* `SecurityException`– If the caller does not have `CoordinationPermission[PARTICIPANT]` for this Coordination.

**130.5.2.16 public boolean isTerminated()**

- Returns whether this Coordination is terminated.

*Returns* true if this Coordination is terminated, otherwise false if this Coordination is active.

**130.5.2.17 public void join(long timeMillis) throws InterruptedException**

*timeMillis* Maximum time in milliseconds to wait. Specifying a time of 0 will wait until this Coordination is terminated.

- Wait until this Coordination is terminated and all registered Participants have been notified.

*Throws* `InterruptedException`– If the wait is interrupted.

`IllegalArgumentException`– If the specified time is negative.

SecurityException– If the caller does not have CoordinationPermission[PARTICIPATE] for this Coordination.

### 130.5.2.18 **public Coordination push()**

- Push this Coordination object onto the thread local Coordination stack to make it the current Coordination.

*Returns* This Coordination.

*Throws* CoordinationException– If this Coordination is already on the any thread's thread local Coordination stack or this Coordination is terminated.

SecurityException– If the caller does not have CoordinationPermission[INITIATE] for this Coordination.

## 130.5.3 **public class CoordinationException extends RuntimeException**

Unchecked exception which may be thrown by a Coordinator implementation.

### 130.5.3.1 **public static final int ALREADY\_ENDED = 4**

The Coordination has already terminated normally.

### 130.5.3.2 **public static final int ALREADY\_PUSHED = 5**

The Coordination was already on a thread's thread local Coordination stack.

### 130.5.3.3 **public static final int DEADLOCK\_DETECTED = 1**

Registering a Participant with a Coordination would have resulted in a deadlock.

### 130.5.3.4 **public static final int FAILED = 2**

The Coordination has terminated as a failure with Coordination.fail(Throwable). When this exception type is used, the getCause() method must return a non-null value.

### 130.5.3.5 **public static final int LOCK\_INTERRUPTED = 6**

The current thread was interrupted while waiting to register a Participant with a Coordination.

### 130.5.3.6 **public static final int PARTIALLY\_ENDED = 3**

The Coordination has partially ended.

### 130.5.3.7 **public static final int UNKNOWN = 0**

Unknown reason for this exception.

### 130.5.3.8 **public static final int WRONG\_THREAD = 7**

The Coordination cannot be ended by the calling thread since the Coordination is on the thread local Coordination stack of another thread.

### 130.5.3.9 **public CoordinationException(String message,Coordination coordination,int type,Throwable cause)**

*message* The detail message for this exception.

*coordination* The Coordination associated with this exception.

*cause* The cause associated with this exception.

*type* The type of this exception.

- Create a new Coordination Exception with a cause.

*Throws* IllegalArgumentException– If the specified type is FAILED and the specified cause is null.

**130.5.3.10 public CoordinationException(String message,Coordination coordination,int type)**

*message* The detail message for this exception.

*coordination* The Coordination associated with this exception.

*type* The type of this exception.

- Create a new Coordination Exception.

*Throws* IllegalArgumentException– If the specified type is FAILED .

**130.5.3.11 public long getId()**

- Returns the id of the Coordination associated with this exception.

*Returns* The id of the Coordination associated with this exception or -1 if no Coordination is associated with this exception.

**130.5.3.12 public String getName()**

- Returns the name of the Coordination associated with this exception.

*Returns* The name of the Coordination associated with this exception or "<" if no Coordination is associated with this exception.

**130.5.3.13 public int getType()**

- Returns the type for this exception.

*Returns* The type of this exception.

**130.5.4 public final class CoordinationPermission extends BasicPermission**

A bundle's authority to create or use a Coordination.

CoordinationPermission has three actions: initiate, participate and admin.

*Concurrency* Thread-safe

**130.5.4.1 public static final String ADMIN = "admin"**

The action string admin.

**130.5.4.2 public static final String INITIATE = "initiate"**

The action string initiate.

**130.5.4.3 public static final String PARTICIPATE = "participate"**

The action string participate.

**130.5.4.4 public CoordinationPermission(String filter,String actions)**

*filter* A filter expression. Filter attribute names are processed in a case sensitive manner. A special value of "\*" can be used to match all coordinations.

*actions* admin, initiate or participate (canonical order).

- Creates a new granted CoordinationPermission object. This constructor must only be used to create a permission that is going to be checked.

Examples:

```
(coordination.name=com.acme.*)
(&(signer=\*,o=ACME,c=US)(coordination.name=com.acme.*))
(signer=\*,o=ACME,c=US)
```

When a signer key is used within the filter expression the signer value must escape the special filter chars (\*, (, ')).

The name is specified as a filter expression. The filter gives access to the following attributes:

- `signer` - A Distinguished Name chain used to sign the exporting bundle. Wildcards in a DN are not matched according to the filter string rules, but according to the rules defined for a DN chain.
- `location` - The location of the exporting bundle.
- `id` - The bundle ID of the exporting bundle.
- `name` - The symbolic name of the exporting bundle.
- `coordination.name` - The name of the requested coordination.

Filter attribute names are processed in a case sensitive manner.

*Throws* `IllegalArgumentException`– If the filter has an invalid syntax.

#### **130.5.4.5      `public CoordinationPermission(String coordinationName, Bundle coordinationBundle, String actions)`**

*coordinationName* The name of the requested Coordination.

*coordinationBundle* The bundle which created the requested Coordination.

*actions* admin, initiate or participate (canonical order).

- Creates a new requested `CoordinationPermission` object to be used by the code that must perform `checkPermission`. `CoordinationPermission` objects created with this constructor cannot be added to an `CoordinationPermission` permission collection.

#### **130.5.4.6      `public boolean equals(Object obj)`**

*obj* The object to test for equality with this `CoordinationPermission` object.

- Determines the equality of two `CoordinationPermission` objects. This method checks that specified permission has the same name and `CoordinationPermission` actions as this `CoordinationPermission` object.

*Returns* true if *obj* is a `CoordinationPermission`, and has the same name and actions as this `CoordinationPermission` object; false otherwise.

#### **130.5.4.7      `public String getActions()`**

- Returns the canonical string representation of the `CoordinationPermission` actions.

Always returns present `CoordinationPermission` actions in the following order: admin, initiate, participate.

*Returns* Canonical string representation of the `CoordinationPermission` actions.

#### **130.5.4.8      `public int hashCode()`**

- Returns the hash code value for this object.

*Returns* A hash code value for this object.

#### **130.5.4.9      `public boolean implies(Permission p)`**

*p* The requested permission.

- Determines if the specified permission is implied by this object.

This method checks that the filter of the target is implied by the coordination name of this object. The list of `CoordinationPermission` actions must either match or allow for the list of the target object to imply the target `CoordinationPermission` action.



*Returns* true if the specified permission is implied by this object; false otherwise.

#### 130.5.4.10 **public PermissionCollection newPermissionCollection()**

- Returns a new PermissionCollection object suitable for storing CoordinationPermission objects.

*Returns* A new PermissionCollection object.

### 130.5.5 **public interface Coordinator**

A Coordinator service coordinates activities between different parties.

A bundle can use the Coordinator service to create Coordination objects. Once a Coordination object is created, it can be pushed on the thread local Coordination stack to be an implicit parameter as the current Coordination for calls to other parties, or it can be passed directly to other parties as an argument. The current Coordination, which is on the top of the current thread's thread local Coordination stack, can be obtained with peek().

Any active Coordinations created by a bundle must be terminated when the bundle releases the Coordinator service. The Coordinator service must fail these Coordinations with the RELEASED exception.

A Participant can register to participate in a Coordination and receive notification of the termination of the Coordination.

The following example code shows a example usage of the Coordinator service.

```
void foo() {
    Coordination c = coordinator.begin("work", 0);
    try {
        doWork();
    } catch (Exception e) {
        c.fail(e);
    } finally {
        c.end();
    }
}
```

In the doWork method, code can be called that requires notification of the termination of the Coordination. The doWork method can then register a Participant with the Coordination.

```
void doWork() {
    if (coordinator.addParticipant(this)) {
        beginWork();
    } else {
        beginWork();
        finishWork();
    }
}

void ended(Coordination c) {
    finishWork();
}

void failed(Coordination c) {
    undoWork();
}
```

*Concurrency* Thread-safe

*Provider Type* Consumers of this API must not implement this type

### 130.5.5.1 **public boolean addParticipant(Participant participant)**

*participant* The Participant to register with the current Coordination. The participant must not be null.

- Register a Participant with the current Coordination.

If there is no current Coordination, this method does nothing and returns false.

Otherwise, this method calls `Coordination.addParticipant(Participant)` with the specified Participant on the current Coordination and returns true.

*Returns* false if there was no current Coordination, otherwise returns true.

*Throws* `CoordinationException`– If the Participant could not be registered with the current Coordination. This exception should normally not be caught by the caller but allowed to be caught by the initiator of this Coordination.

`SecurityException`– If the caller does not have `CoordinationPermission[PARTICIPATE]` for the current Coordination.

*See Also* `Coordination.addParticipant(Participant)`

### 130.5.5.2 **public Coordination begin(String name,long timeMillis)**

*name* The name of this coordination. The name does not have to be unique but must follow the symbolic-name syntax from the Core specification.

*timeMillis* Timeout in milliseconds. A value of 0 means no timeout is required. If the Coordination is not terminated within the timeout, the Coordinator service will fail the Coordination with a `TIMEOUT` exception.

- Create a new Coordination and make it the current Coordination.

This method does that same thing as calling `create(name, timeMillis).push()`

*Returns* A new Coordination object

*Throws* `IllegalArgumentException`– If the specified name does not follow the symbolic-name syntax or the specified time is negative.

`SecurityException`– If the caller does not have `CoordinationPermission[INITIATE]` for the specified name and creating bundle.

### 130.5.5.3 **public Coordination create(String name,long timeMillis)**

*name* The name of this coordination. The name does not have to be unique but must follow the symbolic-name syntax from the Core specification.

*timeMillis* Timeout in milliseconds. A value of 0 means no timeout is required. If the Coordination is not terminated within the timeout, the Coordinator service will fail the Coordination with a `TIMEOUT` exception.

- Create a new Coordination.

*Returns* The new Coordination object.

*Throws* `IllegalArgumentException`– If the specified name does not follow the symbolic-name syntax or the specified time is negative.

`SecurityException`– If the caller does not have `CoordinationPermission[INITIATE]` for the specified name and creating bundle.

### 130.5.5.4 **public boolean fail(Throwable cause)**

*cause* The failure cause. The failure cause must not be null.

- Terminate the current Coordination as a failure with the specified failure cause.

If there is no current Coordination, this method does nothing and returns false.

Otherwise, this method returns the result from calling `Coordination.fail(Throwable)` with the specified failure cause on the current Coordination.

*Returns* false if there was no current Coordination, otherwise returns the result from calling `Coordination.fail(Throwable)` on the current Coordination.

*Throws* `SecurityException`– If the caller does not have `CoordinationPermission[PARTICIPATE]` for the current Coordination.

*See Also* `Coordination.fail(Throwable)`

### 130.5.5.5 **public Coordination getCoordination(long id)**

*id* The id of the requested Coordination.

- Returns the Coordination with the specified id.

*Returns* A Coordination having with specified id or null if no Coordination with the specified id exists, the Coordination with the specified id is terminated or the caller does not have `CoordinationPermission[ADMIN]` for the Coordination with the specified id.

### 130.5.5.6 **public Collection<Coordination> getCoordinations()**

- Returns a snapshot of all active Coordinations.

Since Coordinations can be terminated at any time, Coordinations in the returned collection can be terminated before the caller examines the returned collection.

The returned collection must only contain the Coordinations for which the caller has `CoordinationPermission[ADMIN]`.

*Returns* A snapshot of all active Coordinations. If there are no active Coordinations, the returned list will be empty. The returned collection is the property of the caller and can be modified by the caller.

### 130.5.5.7 **public Coordination peek()**

- Returns the current Coordination.

The current Coordination is the Coordination at the top of the thread local Coordination stack. If the thread local Coordination stack is empty, there is no current Coordination. Each Coordinator service maintains thread local Coordination stacks.

This method does not alter the thread local Coordination stack.

*Returns* The current Coordination or null if the thread local Coordination stack is empty.

### 130.5.5.8 **public Coordination pop()**

- Remove the current Coordination from the thread local Coordination stack.

The current Coordination is the Coordination at the top of the thread local Coordination stack. If the thread local Coordination stack is empty, there is no current Coordination. Each Coordinator service maintains its own thread local Coordination stacks.

This method alters the thread local Coordination stack, if it is not empty, by removing the Coordination at the top of the thread local Coordination stack.

*Returns* The Coordination that was the current Coordination or null if the thread local Coordination stack is empty.

*Throws* `SecurityException`– If the caller does not have `CoordinationPermission[INITIATE]` for the current Coordination.

## 130.5.6 **public interface Participant**

A Participant participates in a Coordination.

A Participant can participate in a Coordination by registering itself with the Coordination. After successfully registering itself, the Participant is notified when the Coordination is terminated.

If a Coordination terminates normally, then all registered Participants are notified on their `ended(Coordination)` method. If the Coordination terminates as a failure, then all registered Participants are notified on their `failed(Coordination)` method.

Participants are required to be thread safe as notification can be made on any thread.

A Participant can only be registered with a single active Coordination at a time. If a Participant is already registered with an active Coordination, attempts to register the Participation with another active Coordination will block until the Coordination the Participant is registered with terminates. Notice that in edge cases the notification to the Participant that the Coordination has terminated can happen before the registration method returns.

*Concurrency* Thread-safe

#### 130.5.6.1 **public void ended(Coordination coordination) throws Exception**

*coordination* The Coordination that has terminated normally.

- Notification that a Coordination has terminated normally.

This Participant should finalize any work associated with the specified Coordination.

*Throws* Exception– If this Participant throws an exception, the Coordinator service should log the exception. The `Coordination.end()` method which is notifying this Participant must continue notification of other registered Participants. When this is completed, the `Coordination.end()` method must throw a `CoordinationException` of type `CoordinationException.PARTIALLY_ENDED`.

#### 130.5.6.2 **public void failed(Coordination coordination) throws Exception**

*coordination* The Coordination that has terminated as a failure.

- Notification that a Coordination has terminated as a failure.

This Participant should discard any work associated with the specified Coordination.

*Throws* Exception– If this Participant throws an exception, the Coordinator service should log the exception. The `Coordination.fail(Throwable)` method which is notifying this Participant must continue notification of other registered Participants.

## 130.6 References

- [1] *OSGi Core Release 6*  
<http://www.osgi.org/Specifications/HomePage>

# 132 Repository Service Specification

## Version 1.1

### 132.1 Introduction

The guiding force behind the OSGi Specifications is a reusable component model. The *OSGi Core Release 6* provides a solid foundation for such a component model by providing a component collaboration framework with a comprehensive management model. The service specifications provide the abstract APIs to allow many different collaborations between components. This Repository Service Specification provides the capability to manage the external access to components and other resources.

Though the Repository service can be used as a standalone service to search and retrieve general binary artifacts, called resources, it is intended to be used in conjunction with the *Resolver Service Specification* on page 1003.

The model of the Repository is based on the generic Requirement-Capability model defined in [3] *Resource API Specification*, this chapter relies on the definitions of the generic model.

#### 132.1.1 Essentials

- *External* - Provide access to external components and resources.
- *Resolve* - The Repository API must be closely aligned with the Resolver API since they are intended to be used in conjunction.
- *Searching* - Support general queries.
- *Metadata* - Allow resources to provide content information.
- *Retrieval* - Allow the retrieval of Resources from remote locations.
- *Batching* - Repositories must be able to batch queries.
- *Distribution* - Allow Repositories to be defined with a simple storage scheme such that Repositories can be distributed on a removable media like a CD/DVD.
- *Mirroring* - Repositories must be able to support selecting a remote site based on the local situation.

#### 132.1.2 Entities

- *Repository* - A facade to a (remote) set of resources described by capabilities.
- *Resource* - An artifact that has requirements that must be satisfied before it is available but provides capabilities when it becomes available.
- *Requirement* - An expression that asserts a capability.
- *Capability* - Describes a feature of the resource so that it can be required by a requirement.
- *Resource Content* - Provides access to the underlying bytes of the resource in the default format.

Figure 132.1 Class and Service overview

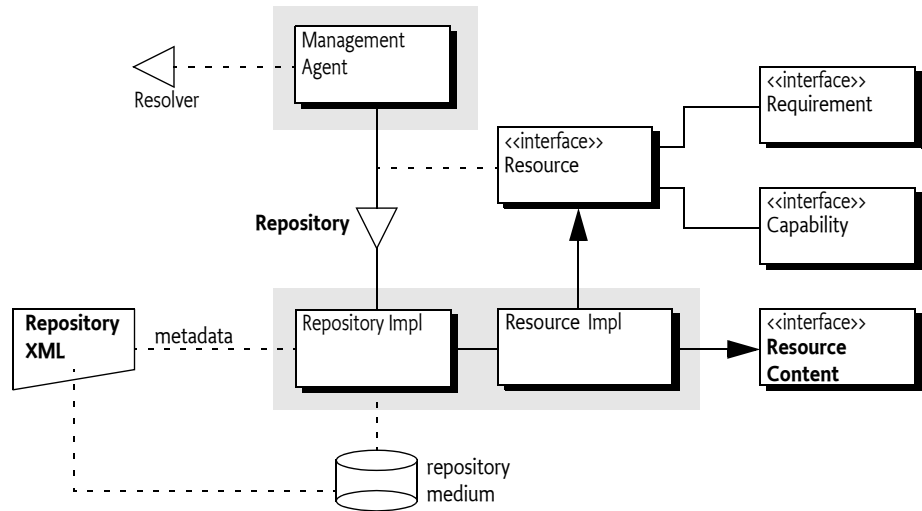

### 132.1.3

## Synopsis

There are many different repositories available on the Internet or on fixed media. A repository can be made available to bundles by providing a Repository service. If such a bundle, for example a Management Agent performing a provisioning operation, finds that it has an unmatched requirement then it can query the repository services to find matching capabilities. The Repository service can implement the query in many different ways. It can ship the requirement to a remote side to be processed or it can process the query locally.

This specification also provides an XML schema that can be used to describe a Repository. Instances of this schema can be downloaded from a remote repository for local indexing or they can be stored for example on a DVD together with the resources.

## 132.2 Using a Repository

The Repository service provides an abstraction to a, potentially remote, set of resources. In the generic Capability-Requirement model, resources are modeled to declare capabilities and requirements. The primary purpose of a Repository is to enable a management agent that uses the Resolver API to leverage a wide array of repositories. This Repository service specification allows different Repository providers to be installed as bundles, and each bundle can register multiple Repository services. The Repository is sufficiently abstract to allow many different implementations.

Repository services are identified by a number of service properties:

- `service.pid` - A mandatory unique identity for this Repository service.
- `service.description` - An optional human readable name for this Repository.
- `repository.url` - Optional URLs to landing pages of the repository, if they exist.

In general, the users of the Repository service should aggregate all services in the service registry. This strategy allows the deployer to control the available Repositories. The following example, using Declarative Service annotations to show the dependencies on the service registry, shows how to aggregate the different Repository services.

```
List<Repository> repos = new CopyOnWriteArrayList<Repository>();
```

```

@Reference(
cardinality = ReferenceCardinality.MULTIPLE,
policy = ReferencePolicy.DYNAMIC)
void addRepository( Repository repo ) { repos.add(repo); }
void removeRepository( Repository repo ) { repos.remove(repo); }

```

To access a resource in a Repository service it is necessary to construct a requirement, pass this to the Repository service, and then use the returned capabilities to satisfy the resolver or to get the resource from the capability. The Repository then returns all matching capabilities. The requirement matches the capability if their namespaces match and the requirement's filter is absent or matches the attributes.

The [findProviders\(Collection\)](#) method takes a Collection of requirements. The reason for this collection is that it allows the caller to specify multiple requirements simultaneously so that Repositories can batch requests, the requirements in this collection are further unrelated. That is, they do not form an expression in any way. Multiple requirements as the parameter means that the result must be a map so that the caller can find out what requirement matched what capabilities. For example:

```

List<Capability> find( Requirement r ){
    List<Capability> result = new ArrayList<Capability>();

    for ( Repository repo : repos ) {
        Map<Requirement,Collection<Capability>> answer =
            repo.findProviders( Collections.singleton( r ) );
        result.addAll( answer.get( r ) );
    }
    return result;
}

```

Access to resources is indirect since the Repository returns capabilities. Each capability is declared in a resource and the `getResource()` method provides access to the underlying resource. Since each resource declares an `osgi.identity` capability it is possible to retrieve a resource from a repository if the identity name, type, and version are known. For example, to get a bundle resource:

```

Resource getResource( String type, String name, Version version ) {
    String filter = String.format(
        "(&(type=%s)(osgi.identity=%s)(version=%s))",
        type,
        name,
        version );

    RequirementBuilder builder = repo.newRequirementBuilder("osgi.identity");
    builder.addDirective("filter", filter);
    Requirement r = builder.build();

    List<Capability> capabilities = find( r );
    if ( capabilities.isEmpty() )
        return null;
    return capabilities.get( 0 ).getResource();
}

```

Resources that originate from Repository services must implement the [RepositoryContent](#) interface, this interface provides stream access to the default storage format. It is therefore possible to get the content with the following code.

```

InputStream getContent( String type, Stringname, Version version ) {

```

```

Resource r = getResource( type, name, version );
if ( r == null )
    return null;
return ((RepositoryContent)r).getContent();
}

```

The `getContent()` method returns an Input Stream in the default format for that resource type. Resources from a Repository should also have one or more `osgi.content` capabilities that advertise the same resource in the same or different formats. The `osgi.content` capability has a number of attributes that provide information about the resource's download format:

- `osgi.content` - A unique SHA-256 for the content as read from the URL.
- `url` - A URL to the content.
- `mime` - An IANA MIME type for the content.
- `size` - Size in bytes of the content.

It is therefore possible to search for a specific MIME type and download that format. For example:

```

String getURL( String type, String name, Version version, String mime )
    throws Exception {
    Resource r = getResource( type, name, version );
    for ( Capability cap : r.getCapabilities( "osgi.content" ) ) {
        Map<String, Object> attrs = cap.getAttributes();
        String actual = (String) attrs.get( "mime" );
        if ( actual != null && mime.equalsIgnoreCase( actual ) ) {
            String url = (String) attrs.get( "url" );
            if ( url != null )
                return url;
        }
    }
    return null;
}

```

Since the `osgi.content` capability contains the SHA-256 digest as the `osgi.content` attribute it is possible to verify the download that it was correct.

Every resource has an `osgi.identity` capability. This namespace defines, in [2] *Framework Namespaces*, the possibility to add related resources, for example *javadoc* or *sources*. A resource then has informational requirements to `osgi.identity` capabilities; these requirements are marked with a classifier directive that holds the type of *relation*. The following example shows how it would be possible to find such a related resource:

```

InputStream getRelated( Resource resource, String classifier )
    throws Exception {
    for ( Requirement r : resource.getRequirements( "osgi.identity" ) ) {
        if ( classifier.equals( r.getDirectives().get( "classifier" ) ) ) {
            Collection<Capability> capabilities =
                repository.findProviders( Collections.singleton( r ) ).get( r );

            if ( capabilities.isEmpty() )
                continue;

            Capability c = capabilities.iterator().next();
            Resource related = c.getResource();
            return ((RepositoryContent)related).getContent();
        }
    }
}

```



```

    }
    return null;
}

```

### 132.2.1 Combining Requirements

In some cases it may be useful to find resources in the repository that satisfy criteria across multiple namespaces.

A simple Requirement object can contain a filter that makes assertions about capability attributes within a single namespace. So for example, a single requirement can state that a package `org.example.mypkg` must be exported in a version between 3.1 inclusive and 4.0 exclusive:

```

RequirementBuilder rb = repo.newRequirementBuilder("osgi.wiring.package");
String rf = "(&(osgi.wiring.package=org.example.mypkg)"
    + "(version>=3.1)!(version>=4.0))";
rb.addDirective("filter", rf);
Requirement r = rb.build();

```

This requirement contains three conditions on the `osgi.wiring.package` capability.

In some situations it may be needed to specify requirements that cover multiple namespaces. For example a bundle might be needed that exports the above package, but the bundle must also have the Apache License, Version 2.0 license. A resource's license is available as an attribute on the `osgi.identity` namespace. Constructing a constraint that combines requirements from multiple namespaces can be done by using an Expression Combiner, which can be obtained from the Repository service. The Repository service provides a [findProviders\(RequirementExpression\)](#) overload that can take a requirement expression and returns a Promise to a collection of matching resources.

```

RequirementBuilder lb = repo.newRequirementBuilder("osgi.identity");
String lf = "(license=http://opensource.org/licenses/Apache-2.0)";
lb.addDirective("filter", lf);

RequirementExpression expr = repo.getExpressionCombiner().and(
    lb.buildExpression(), rb.buildExpression());

Promise<Collection<Resource>> p = repo.findProviders(expr);

// Let findProviders() do its work async and update a ui component
// once the result is available
p.then(new Success<Collection<Resource>, Void>() {
    public Promise<Void> call(Promise<Collection<Resource>> resolved)
        throws Exception {
        ui.update(resolved.getValue());
        return null;
    }
});

// Instead of the async chain above its also possible to
// wait for the promise value synchronously:
// Collection<Resource> resources = p.getValue();

```

For more details on OSGi Promises, see the *Promises Specification* on page 1137.

## 132.3 Repository

A Repository service provides access to capabilities that satisfy a given requirement. A Repository can be the facade of a remote server containing a large amount of resources, a repository on removable media, or even a collection of bundles inside a ZIP file. A Repository communicates in terms of requirements and capabilities as defined in [3] *Resource API Specification*. This model is closely aligned with the *Resolver Service Specification* on page 1003.

A Repository service must be registered with the service properties given in the following table.

Table 132.1

*Repository Service Properties*

Attribute	Opt	Type	Description
service.pid	mandatory	String	A globally unique identifier for this Repository.
service.description	optional	String	The Repository Name
repository.url	optional	String+	URLs related to this Repository.

The Repository implements the following methods:

- [findProviders\(Collection\)](#) - For each requirement find all the capabilities that match that requirement and return them as a `Map<Requirement,Collection<Capability>>`.
- [findProviders\(RequirementExpression\)](#) - Find all resources that match the requirement expression. The requirement expression is used to combine multiple requirements using the and, or and not operators.
- [getExpressionCombiner\(\)](#) - Obtain an expression combiner. This expression combiner is used to produce requirement expressions from simple requirements or other requirement expressions.
- [newRequirementBuilder\(String\)](#) - Obtain a convenience builder for Requirement objects.

A Repository must not perform any namespace specific actions or matching. The Repository must therefore match a requirement to a capability with the following rules:

- The namespace must be identical, and
- The requirement's filter is absent or it must match the capability's attributes.

Resources originating from a Repository service must additionally:

- Implement the [RepositoryContent](#) interfaces, see *Repository Content* on page 894.
- Provide at least one `osgi.content` Capability, see *osgi.content Namespace* on page 894.

### 132.3.1 Repository Content

Resources originating from a Repository must implement the [RepositoryContent](#) interface. The purpose of this interface is to allow users of the Repositories access to an Input Stream that provides access to the resource.

The [RepositoryContent](#) interface provides a single method:

- [getContent\(\)](#) - Return an Input Stream for the resource, if more than one `osgi.content` capability is present the content associated with the first capability is returned.

## 132.4 osgi.content Namespace

A resource is a logical concept, to install a resource in an environment it is necessary to get access to its *contents*. A resource can be formatted in different ways. It is possible to deliver a bundle as a JAR file, a Pack200 file, or some other format. In general, the [RepositoryContent](#) interface provides access to the default format.

The Repository can advertise the different formats with `osgi.content` capabilities. Each of those capabilities is identified with a unique SHA-256 checksum and has a URL for the resource in the specified format. The size and mime attributes provide information the download format, this can be used for selection. If more than one `osgi.content` capability is associated with a resource, the first capability must represent the default format. If the resource has a standard or widely used format (e.g., JAR for bundles and ESA for subsystems), and that format is provided as part of the repository, then that format should be the default format.

The `osgi.content` Namespace supports the attributes defined in the following table and [Content-Namespace](#).

Table 132.2 *osgi.content* definition

Name	Kind	M/O	Type	Syntax	Description
<code>osgi.content</code>	CA	M	String	<code>[0-9a-fA-F]{64}</code>	The SHA-256 hex encoded digest for this resource
<code>url</code>	CA	M	String	<code>&lt;url&gt;</code>	The URL to the bytes. This must be an absolute URL.
<code>size</code>	CA	M	Long	<code>[0-9]+</code>	The size of the resource in bytes as it will be read from the URL.
<code>mime</code>	CA	M	String	<code>&lt;mime type&gt;</code>	An IANA defined MIME type for the format of this content.

## 132.5 XML Repository Format

This is an optional part of the specification since the Repository interface does not provide access how the Repository obtains its information. However, the purpose of this part of the specification is to provide a commonly recognized format for interchanging Repository metadata.

This section therefore describes an XML schema to represent Repository content. It is expected that Internet based Repositories can provide such an XML file to clients. A Repository XML file can be used as a common interchange format between multiple Repository implementations.

The Repository XML describes a number of resources with their capabilities and requirements. Additionally the XML can refer to other Repository XML files. The XML Schema can be found at its XML namespace, see *XML Repository Schema* on page 898. The XML structure, which closely follows the Requirement-Capability model, is depicted in Figure 132.2.

Figure 132.2 *XML Structure*

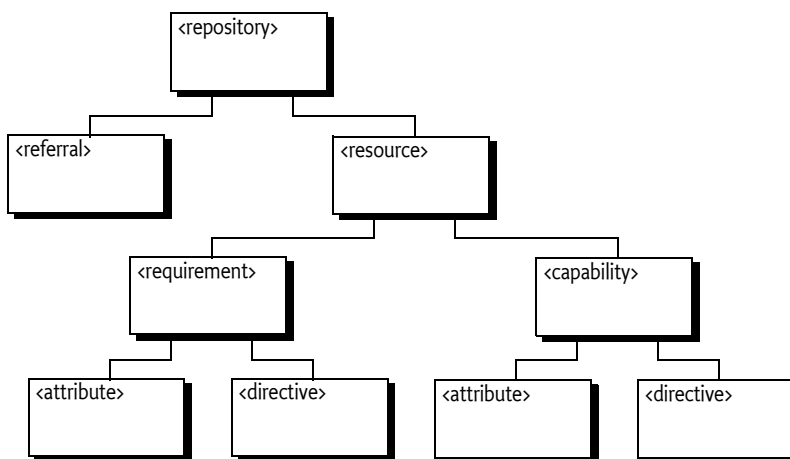

The different elements are discussed in the following sections. All types are derived from the XML Schema types, see [4] *XML Schema Part 2: Data types Second Edition*.

### 132.5.1 Repository Element

The repository element is the root of the document. The repository element has the following child elements:

- `referral*` - Referrals to other repositories for a federated model, see *Referral Element* on page 896.
- `resource*` - Resource definitions, see *Resource Element* on page 896.

The repository element has the attributes defined in the following table.

Table 132.3

*repository element attributes*

Attribute	Type	Description
name	NCName	The name of this Repository. For informational purposes.
increment	long	Counter which increments every time the repository is changed. Can be used by clients to check for changes. The counter is not required to increase monotonically.

### 132.5.2 Referral Element

The purpose of the referral element is to allow a Repository to refer to other Repositories, allowing for federated Repositories. Referrals are applied recursively. However, this is not always desired. It is therefore possible to limit the depth of referrals. If the depth attribute is  $\geq 1$ , the referred repository must be included but it must not follow any referrals from the referred repository. If the depth attribute is more than one, referrals must be included up to the given depth. Depths of referred repositories must also be obeyed, where referred repositories may reduce the effective depth but not increase it. For example if a top repository specifies a depth of 5 and a level 3 repository has a depth of 1 then the repository on level 5 must not be used. If not specified then there is no limit to the depth. Referrals that have cycles must be ignored, a resource of a given Repository must only occur once in a Repository.

The referral element has the attributes defined in the following table.

Table 132.4

*referral element attributes*

Attribute	Type	Description
depth	int	The max depth of referrals
url	anyURI	A URL to where the referred repository XML can be found. The URL can be absolute or relative to the URI of the current XML resource.

### 132.5.3 Resource Element

The resource element defines a Resource. The resource element has the following child elements:

- `requirement*` - The requirements of this resource, see *Requirement Element* on page 897.
- `capability*` - The capabilities of this resource, see *Capability Element* on page 896.

The Resource element has no attributes.

### 132.5.4 Capability Element

The capability element maps to a capability, it holds the attributes and directives. The capability element has the following child elements:

- `directive*` - The directives for the capability, see *Directive Element* on page 898.

- `attribute*` - The attributes for the capability, see *Attribute Element* on page 897.

The capability element has the attributes defined in the following table.

Table 132.5 *capability element attributes*

Attribute	Type	Description
namespace	token	The namespace of this capability

### 132.5.5 Requirement Element

The requirement element maps to a requirement, it holds the attributes and directives. The requirement element has the following child elements:

- `directive*` - The directives for the requirement, see *Directive Element* on page 898.
- `attribute*` - The attributes for the requirement, see *Attribute Element* on page 897.

The requirement element has the attributes defined in the following table.

Table 132.6 *requirement element attributes*

Attribute	Type	Description
namespace	token	The namespace of this requirement

### 132.5.6 Attribute Element

An attribute element describes an attribute of a capability or requirement. Attributes are used to convey information about the Capability-Requirement. Attributes for the capability are used for matching the requirement's filter. The meaning of attributes is described with the documentation of the namespace in which they reside.

Attributes are optionally typed according to the [1] *Framework Module Layer* specification. The default type is String, the value of the value attribute. However, if a type attribute is specified and it is not String then the value attribute must be converted according to the type attribute specifier. The syntax of the type attribute is as follows:

```
type ::= list | scalar
list ::= 'List<' scalar '>' // no spaces between terminals
scalar ::= 'String' | 'Version' | 'Long' | 'Double'
```

A list conversion requires the value to be broken in tokens separated by comma (',' \u002C). White space around the list and around commas must be trimmed for non-String types. Each token must then be converted to the given type according to the scalar type specifier. The exact rules for the comma separated lists are defined in [1] *Framework Module Layer*, see *Bundle Capability Attributes*.

The conversion of value *s*, when scalar, must take place with the following methods:

- String - No conversion, use *s*
- Version - `Version.parseVersion(s)`
- Long - After trimming whitespace, `Long.parseLong(s)`
- Double - After trimming whitespace, `Double.parseDouble(s)`

The attribute element has the attributes defined in the following table.

Table 132.7 *attribute element attributes*

Attribute	Type	Description
name	token	The name of the attribute
value	string	The value of the attribute.
type		The type of the attribute, the syntax is outlined in the previous paragraphs.

### 132.5.7 Directive Element

A directive element describes a directive of a capability or a requirement. Directives are used to convey information about the Capability-Requirement. The meaning of directives is described with the documentation of the namespace in which they reside.

The directive element has the attributes defined in the following table.

Table 132.8 *directive element attributes*

Attribute	Type	Description
name	token	The name of the attribute
value	string	The value of the attribute.

### 132.5.8 Sample XML File

The following example shows a very small XML file. The file contains one resource.

```
<repository name='OSGiRepository'
  increment='13582741'
  xmlns='http://www.osgi.org/xmlns/repository/v1.0.0'>
  <resource>

    <requirement namespace='osgi.wiring.package'>
      <directive name='filter' value=
        '&(osgi.wiring.package=org.apache.commons.pool)(version&gt;=1.5.6)'/>
    </requirement>

    <requirement namespace='osgi.identity'>
      <directive name='effective' value='meta' />
      <directive name='resolution' value='optional' />
      <directive name='filter' value=
        '&(version=1.5.6)(osgi.identity=org.acme.pool-src)'/>
      <directive name='classifier' value='sources' />
    </requirement>

    <capability namespace='osgi.identity'>
      <attribute name='osgi.identity' value='org.acme.pool' />
      <attribute name='version' type='Version' value='1.5.6' />
      <attribute name='type' value='osgi.bundle' />
    </capability>

    <capability namespace='osgi.content'>
      <attribute name='osgi.content' value='e3b0c44298fc1c149afb4c8996fb92427ae41e4649b934ca495991b7852b855' />
      <attribute name='url' value='http://www.acme.com/repository/org/acme/pool/org.acme.pool-1.5.6.jar' />
      <attribute name='size' type='Long' value='4405' />
      <attribute name='mime' value='application/vnd.osgi.bundle' />
    </capability>

    <capability namespace='osgi.wiring.bundle'>
      <attribute name='osgi.wiring.bundle' value='org.acme.pool' />
      <attribute name='bundle-version' type='Version' value='1.5.6' />
    </capability>

    <capability namespace='osgi.wiring.package'>
      <attribute name='osgi.wiring.package' value='org.acme.pool' />
      <attribute name='version' type='Version' value='1.1.2' />
      <attribute name='bundle-version' type='Version' value='1.5.6' />
      <attribute name='bundle-symbolic-name' value='org.acme.pool' />
      <directive name='uses' value='org.acme.pool,org.acme.util' />
    </capability>

  </resource>
</repository>
```

## 132.6 XML Repository Schema

The namespace of this schema is:

<http://www.osgi.org/xmlns/repository/v1.0.0>

The schema for this namespace can be found at the location implied in its name. The recommended prefix for this namespace is `repo`.

```
<schema xmlns="http://www.w3.org/2001/XMLSchema"
  xmlns:repo="http://www.osgi.org/xmlns/repository/v1.0.0"
  targetNamespace="http://www.osgi.org/xmlns/repository/v1.0.0"
  elementFormDefault="unqualified"
  attributeFormDefault="unqualified"
  version="1.0.1">

  <element name="repository" type="repo:Trepository" />
  <complexType name="Trepository">
    <sequence>
      <choice minOccurs="0" maxOccurs="unbounded">
        <element name="resource" type="repo:Tresource" />
        <element name="referral" type="repo:Treferral" />
      </choice>
      <!-- It is non-deterministic, per W3C XML Schema 1.0:
      http://www.w3.org/TR/xmlschema-1/#cos-nonambig
      to use name space="##any" below. -->
      <any namespace="##other" processContents="lax" minOccurs="0"
        maxOccurs="unbounded" />
    </sequence>
    <attribute name="name" type="string">
      <annotation>
        <documentation xml:lang="en">
          The name of the repository. The name may contain
          spaces and punctuation.
        </documentation>
      </annotation>
    </attribute>
    <attribute name="increment" type="long">
      <annotation>
        <documentation xml:lang="en">
          An indication of when the repository was last changed. Client's can
          check if a
          repository has been updated by checking this increment value.
        </documentation>
      </annotation>
    </attribute>
    <anyAttribute processContents="lax" />
  </complexType>

  <complexType name="Tresource">
    <annotation>
      <documentation xml:lang="en">
        Describes a general resource with
        requirements and capabilities.
      </documentation>
    </annotation>
    <sequence>
      <element name="requirement" type="repo:Trequirement" minOccurs="0" maxOccurs="unbounded"/>
      <element name="capability" type="repo:Tcapability" minOccurs="1" maxOccurs="unbounded"/>
      <!-- It is non-deterministic, per W3C XML Schema 1.0:
      http://www.w3.org/TR/xmlschema-1/#cos-nonambig
      to use name space="##any" below. -->
      <any namespace="##other" processContents="lax" minOccurs="0"
        maxOccurs="unbounded" />
    </sequence>
    <anyAttribute processContents="lax" />
  </complexType>

  <complexType name="Treferral">
    <annotation>
      <documentation xml:lang="en">
        A referral points to another repository XML file. The
        purpose of this element is to create a federation of
        repositories that can be accessed as a single
        repository.
      </documentation>
    </annotation>
    <attribute name="depth" type="int" use="optional">
      <annotation>
```

```

        <documentation xml:lang="en">
            The depth of referrals this repository acknowledges.
        </documentation>
    </annotation>
</attribute>
<attribute name="url" type="anyURI" use="required">
    <annotation>
        <documentation xml:lang="en">
            The URL to the referred repository. The URL can be
            absolute or relative from the given repository's
            URL.
        </documentation>
    </annotation>
</attribute>
<anyAttribute processContents="lax" />
</complexType>

<complexType name="Tcapability">
    <annotation>
        <documentation xml:lang="en">
            A named set of type attributes and directives. A capability can be
            used to resolve a requirement if the resource is included.
        </documentation>
    </annotation>
    <sequence>
        <choice minOccurs="0" maxOccurs="unbounded">
            <element name="directive" type="repo:Tdirective" />
            <element name="attribute" type="repo:Tattribute" />
        </choice>
        <!-- It is non-deterministic, per W3C XML Schema 1.0:
        http://www.w3.org/TR/xmlschema-1/#cos-nonambig
        to use name space="##any" below. -->
        <any namespace="##other" processContents="lax" minOccurs="0"
            maxOccurs="unbounded" />
    </sequence>
    <attribute name="namespace" type="string">
        <annotation>
            <documentation xml:lang="en">
                Name space of the capability. Only requirements with the
                same name space must be able to match this capability.
            </documentation>
        </annotation>
    </attribute>
    <anyAttribute processContents="lax" />
</complexType>

<complexType name="Trequirement">
    <annotation>
        <documentation xml:lang="en">
            A filter on a named set of capability attributes.
        </documentation>
    </annotation>
    <sequence>
        <choice minOccurs="0" maxOccurs="unbounded">
            <element name="directive" type="repo:Tdirective" />
            <element name="attribute" type="repo:Tattribute" />
        </choice>
        <!-- It is non-deterministic, per W3C XML Schema 1.0:
        http://www.w3.org/TR/xmlschema-1/#cos-nonambig
        to use name space="##any" below. -->
        <any namespace="##other" processContents="lax" minOccurs="0"
            maxOccurs="unbounded" />
    </sequence>
    <attribute name="namespace" type="string">
        <annotation>
            <documentation xml:lang="en">
                Name space of the requirement. Only capabilities within the
                same name space must be able to match this requirement.
            </documentation>
        </annotation>
    </attribute>
    <anyAttribute processContents="lax" />
</complexType>

<complexType name="Tattribute">

```



```

    <annotation>
      <documentation xml:lang="en">
        A named value with an optional type that decorates
        a requirement or capability.
      </documentation>
    </annotation>
  <sequence>
    <any namespace="##any" processContents="lax" minOccurs="0"
      maxOccurs="unbounded" />
  </sequence>
  <attribute name="name" type="string">
    <annotation>
      <documentation xml:lang="en">
        The name of the attribute.
      </documentation>
    </annotation>
  </attribute>
  <attribute name="value" type="string">
    <annotation>
      <documentation xml:lang="en">
        The value of the attribute.
      </documentation>
    </annotation>
  </attribute>
  <attribute name="type" type="repo:TpropertyType" default="String">
    <annotation>
      <documentation xml:lang="en">
        The type of the attribute.
      </documentation>
    </annotation>
  </attribute>
  <anyAttribute processContents="lax" />
</complexType>

<complexType name="Tdirective">
  <annotation>
    <documentation xml:lang="en">
      A named value of type string that instructs a resolver
      how to process a requirement or capability.
    </documentation>
  </annotation>
  <sequence>
    <any namespace="##any" processContents="lax" minOccurs="0"
      maxOccurs="unbounded" />
  </sequence>
  <attribute name="name" type="string">
    <annotation>
      <documentation xml:lang="en">
        The name of the directive.
      </documentation>
    </annotation>
  </attribute>
  <attribute name="value" type="string">
    <annotation>
      <documentation xml:lang="en">
        The value of the directive.
      </documentation>
    </annotation>
  </attribute>
  <anyAttribute processContents="lax" />
</complexType>

<simpleType name="TpropertyType">
  <restriction base="string">
    <enumeration value="String" />
    <enumeration value="Version" />
    <enumeration value="Long" />
    <enumeration value="Double" />
    <enumeration value="List<&lt;String&&gt;" />
    <enumeration value="List<&lt;Version&&gt;" />
    <enumeration value="List<&lt;Long&&gt;" />
    <enumeration value="List<&lt;Double&&gt;" />
  </restriction>
</simpleType>
<attribute name="must-understand" type="boolean" default="false">

```

```

<annotation>
  <documentation xml:lang="en">
    This attribute should be used by extensions to documents to require that
    the document consumer understand the extension. This attribute must be
    qualified when used.
  </documentation>
</annotation>
</attribute>
</schema>

```

## 132.7 Capabilities

Implementations of the Repository Service specification must provide the capabilities listed in this section.

### 132.7.1 **osgi.implementation Capability**

The Repository Service implementation bundle must provide the `osgi.implementation` capability with name `osgi.repository`. This capability can be used by provisioning tools and during resolution to ensure that a Repository Service implementation is present. The capability must also declare a `uses` constraint for the `org.osgi.service.repository` package and provide the version of this specification:

```

Provide-Capability: osgi.implementation;
                   osgi.implementation="osgi.repository";
                   uses:="org.osgi.service.repository";
                   version:Version="1.1"

```

This capability must follow the rules defined for the *osgi.implementation Namespace* on page 997.

### 132.7.2 **osgi.service Capability**

The Repository Service implementation must provide a capability in the `osgi.service` namespace representing the [Repository](#) service. This capability must also declare a `uses` constraint for the `org.osgi.service.repository` package. For example:

```

Provide-Capability: osgi.service;
                   objectClass:List<String>="org.osgi.service.repository.Repository";
                   uses:="org.osgi.service.repository"

```

This capability must follow the rules defined for the *osgi.service Namespace* on page 997.

## 132.8 Security

### 132.8.1 **External Access**

Repositories in general will get their metadata and artifacts from an external source, which makes them an attack vector for a malevolent Bundle that needs unauthorized external access. Since a Bundle using a Repository has no knowledge of what sources the Repository will access it will be necessary for the Repository to implement the external access in a `doPrivileged` block. Implementations must ensure that callers cannot influence/modify the metadata in such a way that the `getContent()` method could provide access to arbitrary Internet resources. This could for example happen if:

- The implementation relies on the `osgi.content` namespace to hold the URL
- The attributes Map from the `osgi.content` Capability is modifiable

If the malevolent Bundle could change the `osgi.content` attribute it could change it to arbitrary URLs. This example should make it clear that Repository implementations must be very careful.

### 132.8.2 Permissions

Implementations of this specification will need the following minimum permissions.

```
ServicePermission[...Repository, REGISTER ]
SocketPermission[ ... carefully restrict external access...]
```

Users of this specification will need the following minimum permissions.

```
ServicePermission[...Repository, GET ]
```

## 132.9 org.osgi.service.repository

Repository Service Package Version 1.1.

Bundles wishing to use this package must list the package in the Import-Package header of the bundle's manifest. This package has two types of users: the consumers that use the API in this package and the providers that implement the API in this package.

Example import for consumers using the API in this package:

```
Import-Package: org.osgi.service.repository; version="[1.1,2.0)"
```

Example import for providers implementing the API in this package:

```
Import-Package: org.osgi.service.repository; version="[1.1,1.2)"
```

### 132.9.1 Summary

- `AndExpression` - A `RequirementExpression` representing the and of a number of requirement expressions.
- `ContentNamespace` - Content Capability and Requirement Namespace.
- `ExpressionCombiner` - An `ExpressionCombiner` can be used to combine requirement expressions into a single complex requirement expression using the and, or and not operators.
- `IdentityExpression` - A `RequirementExpression` representing a requirement.
- `NotExpression` - A `RequirementExpression` representing the not (negation) of a requirement expression.
- `OrExpression` - A `RequirementExpression` representing the or of a number of requirement expressions.
- `Repository` - A repository service that contains resources.
- `RepositoryContent` - An accessor for the content of a resource.
- `RequirementBuilder` - A builder for requirements.
- `RequirementExpression` - The super interface for all requirement expressions.

### 132.9.2 public interface `AndExpression` extends `RequirementExpression`

A `RequirementExpression` representing the and of a number of requirement expressions.

*Since* 1.1

*Concurrency* Thread-safe

*Provider Type* Consumers of this API must not implement this type

**132.9.2.1 public List<RequirementExpression> getRequirementExpressions()**

- Return the requirement expressions that are combined by this AndExpression.

*Returns* An unmodifiable list of requirement expressions that are combined by this AndExpression. The list contains the requirement expressions in the order they were specified when this requirement expression was created.

**132.9.3 public final class ContentNamespace extends Namespace**

Content Capability and Requirement Namespace.

This class defines the names for the attributes and directives for this namespace. All unspecified capability attributes are of type String and are used as arbitrary matching attributes for the capability. The values associated with the specified directive and attribute keys are of type String, unless otherwise indicated.

*Concurrency* Immutable

**132.9.3.1 public static final String CAPABILITY\_MIME\_ATTRIBUTE = "mime"**

The capability attribute that defines the IANA MIME Type/Format for this content.

**132.9.3.2 public static final String CAPABILITY\_SIZE\_ATTRIBUTE = "size"**

The capability attribute that contains the size, in bytes, of the content. The value of this attribute must be of type Long.

**132.9.3.3 public static final String CAPABILITY\_URL\_ATTRIBUTE = "url"**

The capability attribute that contains the URL to the content.

**132.9.3.4 public static final String CONTENT\_NAMESPACE = "osgi.content"**

Namespace name for content capabilities and requirements.

Also, the capability attribute used to specify the unique identifier of the content. This identifier is the SHA-256 hash of the content.

**132.9.4 public interface ExpressionCombiner**

An ExpressionCombiner can be used to combine requirement expressions into a single complex requirement expression using the and, or and not operators.

*Since* 1.1

*Concurrency* Thread-safe

*Provider Type* Consumers of this API must not implement this type

**132.9.4.1 public AndExpression and(RequirementExpression expr1, RequirementExpression expr2)**

*expr1* The first requirement expression to combine into the returned requirement expression.

*expr2* The second requirement expression to combine into the returned requirement expression

- Combine two RequirementExpressions into a requirement expression using the and operator.

*Returns* An AndExpression representing an and of the specified requirement expressions.

**132.9.4.2 public AndExpression and(RequirementExpression expr1, RequirementExpression expr2, RequirementExpression ... moreExprs)**

*expr1* The first requirement expression to combine into the returned requirement expression.

*expr2* The second requirement expression to combine into the returned requirement expression

*moreExprs* Optional, additional requirement expressions to combine into the returned requirement expression.

- Combine multiple RequirementExpressions into a requirement expression using the and operator.

*Returns* An AndExpression representing an and of the specified requirement expressions.

#### **132.9.4.3      public IdentityExpression identity(Requirement req)**

*req* The requirement to wrap in a requirement expression.

- Wrap a Requirement in an IdentityExpression. This can be useful when working with a combination of Requirements and RequirementExpressions.

*Returns* An IdentityExpression representing the specified requirement.

#### **132.9.4.4      public NotExpression not(RequirementExpression expr)**

*expr* The requirement expression to negate.

- Return the negation of a RequirementExpression.

*Returns* A NotExpression representing the not of the specified requirement expression.

#### **132.9.4.5      public OrExpression or(RequirementExpression expr1,RequirementExpression expr2)**

*expr1* The first requirement expression to combine into the returned requirement expression.

*expr2* The second requirement expression to combine into the returned requirement expression

- Combine two RequirementExpressions into a requirement expression using the or operator.

*Returns* An OrExpression representing an or of the specified requirement expressions.

#### **132.9.4.6      public OrExpression or(RequirementExpression expr1,RequirementExpression expr2,RequirementExpression ... moreExprs)**

*expr1* The first requirement expression to combine into the returned requirement expression.

*expr2* The second requirement expression to combine into the returned requirement expression

*moreExprs* Optional, additional requirement expressions to combine into the returned requirement expression.

- Combine multiple RequirementExpressions into a requirement expression using the or operator.

*Returns* An OrExpression representing an or of the specified requirement expressions.

### **132.9.5      public interface IdentityExpression               extends RequirementExpression**

A RequirementExpression representing a requirement.

*Since* 1.1

*Concurrency* Thread-safe

*Provider Type* Consumers of this API must not implement this type

#### **132.9.5.1      public Requirement getRequirement()**

- Return the Requirement contained in this IdentityExpression.

*Returns* The requirement contained in this IdentityExpression.

### **132.9.6      public interface NotExpression               extends RequirementExpression**

A RequirementExpression representing the not (negation) of a requirement expression.

*Since* 1.1

*Concurrency* Thread-safe

*Provider Type* Consumers of this API must not implement this type

### 132.9.6.1 **public RequirementExpression getRequirementExpression()**

- Return the requirement expression that is negated by this NotExpression.

*Returns* The requirement expression that is negated by this NotExpression.

### 132.9.7 **public interface OrExpression extends RequirementExpression**

A RequirementExpression representing the or of a number of requirement expressions.

*Since* 1.1

*Concurrency* Thread-safe

*Provider Type* Consumers of this API must not implement this type

### 132.9.7.1 **public List<RequirementExpression> getRequirementExpressions()**

- Return the requirement expressions that are combined by this OrExpression.

*Returns* An unmodifiable list of requirement expressions that are combined by this OrExpression. The list contains the requirement expressions in the order they were specified when this requirement expression was created.

### 132.9.8 **public interface Repository**

A repository service that contains resources.

Repositories may be registered as services and may be used as by a resolve context during resolver operations.

Repositories registered as services may be filtered using standard service properties.

*Concurrency* Thread-safe

*Provider Type* Consumers of this API must not implement this type

### 132.9.8.1 **public static final String URL = "repository.url"**

Service property to provide URLs related to this repository.

The value of this property must be of type String, String[], or Collection<String>.

### 132.9.8.2 **public Map<Requirement,Collection<Capability>> findProviders(Collection<? extends Requirement> requirements)**

*requirements* The requirements for which matching capabilities should be returned. Must not be null.

- Find the capabilities that match the specified requirements.

*Returns* A map of matching capabilities for the specified requirements. Each specified requirement must appear as a key in the map. If there are no matching capabilities for a specified requirement, then the value in the map for the specified requirement must be an empty collection. The returned map is the property of the caller and can be modified by the caller. The returned map may be lazily populated, so calling size() may result in a long running operation.

### 132.9.8.3 **public Promise<Collection<Resource>> findProviders(RequirementExpression expression)**

*expression* The RequirementExpression for which matching capabilities should be returned. Must not be null.

- Find the resources that match the specified requirement expression.

*Returns* A promise to a collection of matching Resources. If there are no matching resources, an empty collection is returned. The returned collection is the property of the caller and can be modified by the caller. The returned collection may be lazily populated, so calling `size()` may result in a long running operation.

*Since* 1.1

#### 132.9.8.4 **public ExpressionCombiner getExpressionCombiner()**

- Return an expression combiner. An expression combiner can be used to combine multiple requirement expressions into more complex requirement expressions using `and`, `or` and `not` operators.

*Returns* An ExpressionCombiner.

*Since* 1.1

#### 132.9.8.5 **public RequirementBuilder newRequirementBuilder(String namespace)**

*namespace* The namespace for the requirement to be created.

- Return a new RequirementBuilder which provides a convenient way to create a requirement.

For example:

```
Requirement myReq = repository.newRequirementBuilder("org.foo.ns1").
    addDirective("filter", "(org.foo.ns1=val1)").
    addDirective("cardinality", "multiple").build();
```

*Returns* A new requirement builder for a requirement in the specified namespace.

*Since* 1.1

### 132.9.9 **public interface RepositoryContent**

An accessor for the content of a resource. All Resource objects which represent resources in a Repository must implement this interface. A user of the resource can then cast the Resource object to this type and then obtain an InputStream to the content of the resource.

*Concurrency* Thread-safe

*Provider Type* Consumers of this API must not implement this type

#### 132.9.9.1 **public InputStream getContent()**

- Returns a new input stream to the content of this resource. The content is represented on the resource through the `osgi.content` capability. If more than one such capability is associated with the resource, the first such capability is returned.

*Returns* A new input stream for associated content.

### 132.9.10 **public interface RequirementBuilder**

A builder for requirements.

*Since* 1.1

*Provider Type* Consumers of this API must not implement this type

#### 132.9.10.1 **public RequirementBuilder addAttribute(String name, Object value)**

*name* The attribute name.

*value* The attribute value.

- Add an attribute to the set of attributes.

*Returns* This requirement builder.

**132.9.10.2**      **public RequirementBuilder addDirective(String name,String value)**

*name* The directive name.

*value* The directive value.

- Add a directive to the set of directives.

*Returns* This requirement builder.

**132.9.10.3**      **public Requirement build()**

- Create a requirement based upon the values set in this requirement builder.

*Returns* A requirement created based upon the values set in this requirement builder.

**132.9.10.4**      **public IdentityExpression buildExpression()**

- Create a requirement expression for a requirement based upon the values set in this requirement builder.

*Returns* A requirement expression created for a requirement based upon the values set in this requirement builder.

**132.9.10.5**      **public RequirementBuilder setAttributes(Map<String,Object> attributes)**

*attributes* The map of attributes.

- Replace all attributes with the attributes in the specified map.

*Returns* This requirement builder.

**132.9.10.6**      **public RequirementBuilder setDirectives(Map<String,String> directives)**

*directives* The map of directives.

- Replace all directives with the directives in the specified map.

*Returns* This requirement builder.

**132.9.10.7**      **public RequirementBuilder setResource(Resource resource)**

*resource* The resource.

- Set the Resource.

A resource is optional. This method will replace any previously set resource.

*Returns* This requirement builder.

**132.9.11**      **public interface RequirementExpression**

The super interface for all requirement expressions. All requirement expressions must extend this interface.

*Since* 1.1

*Concurrency* Thread-safe

*Provider Type* Consumers of this API must not implement this type

## 132.10      References

- [1] *Framework Module Layer*  
OSGi Core, Chapter 3 Module Layer



- [2] *Framework Namespaces*  
OSGi Core, Chapter 8, osgi.identity Namespace
- [3] *Resource API Specification*  
OSGi Core, Chapter 6 Resource API Specification
- [4] *XML Schema Part 2: Data types Second Edition*  
<http://www.w3.org/TR/xmlschema-2/>

## 132.11 Changes

- Introduction of *Requirement Expressions* to represent combined requirements.
- Introduction of *Requirement Builder* to facilitate the creation of Requirement objects.
- Changes to default content for the *Repository Content* API and osgi.content capability.
- Introduction of osgi.implementation and osgi.service capabilities.



# 133 Service Loader Mediator Specification

*Version 1.0*

## 133.1 Introduction

Java SE 6 introduced the *Service Loader*, a simple service-provider loading facility, that attempted to unify the different ad-hoc mechanisms used by Java's many factories and builders. The design allows a JAR to advertise the name of one or more embedded classes that implement a given interface and consumers to obtain instances of these implementation classes through the Service Loader API.

Though the Service Loader is about extensibility, its own design is closed and therefore not extendable. It does not support a provider model that would allow different ways of finding interface implementations; its classes are final and its policy is fixed. Unfortunately, the Service Loader's fixed design uses a non-modular class loading policy; it defines its visibility scope with a class loader, which in general requires full visibility of the application's class path. The Service Loader can therefore in OSGi not find implementations from other bundles. Additionally, the Service Loader also does not enforce a life cycle; objects are handed out forever.

Since the Service Loader is the only standardized plugin mechanism in the JRE it is necessary that the mechanism is supported in OSGi with as few changes as possible from the consumer's authors. This specification therefore defines a *mediator* that ensures that the Service Loader is useful in an OSGi Framework, allowing programs that leverage the Service Loader to be used in OSGi frameworks almost as-is.

### 133.1.1 Essentials

- *Compatibility* - Allow JARs that run in a classic Java SE environment that leverage the Service Loader to run in OSGi with only manifest modifications.
- *Services* - Register services for Service Provider bundles that opt-in.
- *Security* - Enforce service permissions for the Service Loader objects.
- *Life Cycle* - Manage the life cycle mismatch between OSGi bundles and the Service Loader's create only model.

### 133.1.2 Entities

- *Service Loader* - An API in Java SE that allows a Consumer to find an implementation of a Service Type from a Service Provider by searching a class loader for Service Providers.
- *Service Type* - The interface or class that the Service Provider must implement/extend.
- *Provider Configuration File* - A resource in the META-INF/services directory that has the fully qualified name of the Service Type and contains one or more fully qualified names of Service Providers.
- *Service Provider* - An implementation class that implements or extends the Service Type.
- *Consumer* - A class that uses the Java SE Service Loader inside an OSGi framework.
- *Mediator* - An extender that mediates between Consumer bundles, the Service Loader API, and Service Provider bundles in an OSGi environment. It consists of a Processor and a Registrar.

- *Processor* - Modifies a bundle that uses the Service Loader API so that it works in an OSGi environment.
- *Registrar* - Registers services on behalf of a bundle that contains Service Providers.

Figure 133.1

Entities

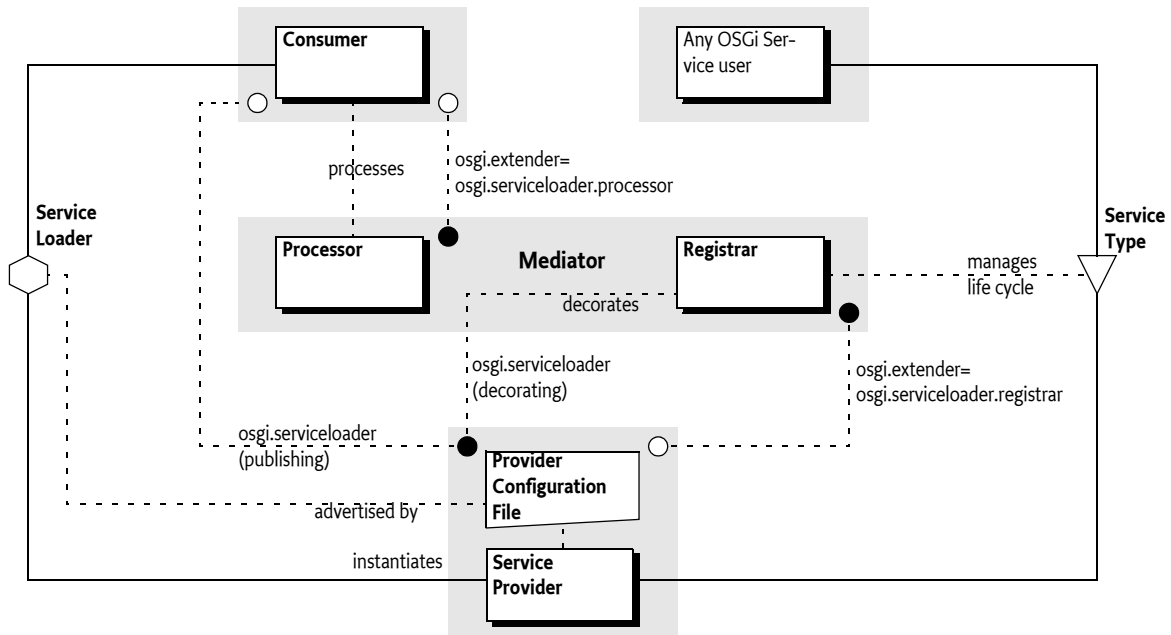

### 133.1.3

## Synopsis

This specification defines two different functions that are provided by a Mediator extender:

- Register OSGi services for each Service Provider.
- Allow Consumers that uses the Service Loader API to access Service Providers from other bundles that would normally not be visible from a bundle.

A Service Provider bundle can provide access to all its Service Providers through OSGi services by declaring a requirement on the `osgi.serviceloader.registrar` extender. This requirement activates a Mediator to inspect the `osgi.serviceloader` capabilities. If no `register` directive is used then all Service Providers for the given Service Type must be registered. Otherwise, each capability can select one Service Provider with the `register` directive. The fully qualified name selects a specific Service Provider, allowing different Service Providers to be registered with different service properties. The Mediator will then register an OSGi service factory for each selected capability. The `osgi.serviceloader` capability's attributes are used to decorate the OSGi service registration with service properties. The service factory returns a new instance for each service get.

Consumers are classes that use the Service Loader API to find Service Provider instances. Since the Service Loader API requires full visibility the Service API fails to work inside an OSGi bundle. A `osgi.serviceloader.processor` extender, which is the Mediator, processes bundles that require this capability by modifying calls to the Service Loader API to ensure that the Service Loader has visibility to published Service Providers.

A Consumer's bundle by default receives visibility to all published Service Providers. Service Providers are published when a bundle declares one or more `osgi.serviceloader` capabilities for a Service Type. If the Consumer has an `osgi.serviceloader` requirement for the given Service Type then the Mediator must only expose the bundles that are wired to those requirements and for each bundle provide all its Service Providers.

## 133.2 Java Service Loader API

Java is quite unique with its focus on separation of *specification* and *implementation*. Virtually all Java Specification Requests (JSR) provide a specification that can be implemented independently by different parties. Though this is one of the industry's best practices it raises a new problem: how to find the implementation available in a Java environment from only the *Service Type*. A Service Type is usually an interface but a base class can also be used.

Finding a Service Provider (the implementation class) from a Service Type is the so called *instance coupling* problem. The use of Service Types removed the type coupling between the Consumer of the contract and the *Service Provider* of the contract (the implementation) but to make things work there is a need of at least one place where the Service Provider is instantiated. The very large number of factories in Java reflects that this is a very common problem.

The general pattern for factories to find Service Providers was to search the class loaders for classes with constant names, varying the package names, often using System properties to extend the different areas to be sought. Though a general pattern based on class loading tricks emerged in the Java VM and application programs, all these patterns differed in details and places where they looked. This became harder and harder to maintain and often caused unexpected instances to be found.

The `java.util.ServiceLoader` class was therefore first introduced in Java SE 6 to provide a generic solution to this problem, see [1] *Java Service Loader API*. With this API Service Providers of a specification can now *advertise* their availability by creating a *Provider Configuration File* in their JAR in the `META-INF/services` directory. The name of this resource is the fully qualified name of the Service Type, the Service Provider provides when instantiated.

The Provider Configuration File contains a number of lines with comments or a class name that implements/extends the Service Type. For example:

```
org.example.Foo
```

A Service Provider must then advertise itself like:

```
META-INF/services/org.example.Foo:  
# Foo implementation  
org.acme.impl.FooImplementation
```

The Service Loader API finds all advertisers by constructing the name of the Provider Configuration File from the Service Type and then calling the `getResources` method on the provided class loader. This returns an enumeration of URLs to the advertisements. It then parses the contents of the resources; that will provide it with a list of Service Providers for the sought Service Type without duplicates. The API will return an iterator that will instantiate an object for the next available Service Provider.

To find the Configuration files for a given Service Type, the Service Loader uses a class loader. The Consumer can select the following class loaders:

- A given class loader as an argument in the call to the constructor
- The Thread Context Class Loader (TCCL)
- The system loader (when null is passed or no TCCL is set)

The class loader restricts the visibility of the Service Loader to only the resources to which the class loader has visibility. If the Service Loader has no access to the advertisement of a Service Provider then it cannot detect it and it will thus not be found.

The Service Provider is loaded from the given class loader, however, the `Class.forName` method is used, which stores it in the cache of the initiating class loader. This means that Service Providers are

not garbage collected as long as there is a resolved bundle that used the Service Loader to get that Service Provider.

In the Service Loader API, the class does not have to originate from the same JAR file as the advertisement. In OSGi this is more restricted, the advertisement must come from the same bundle or must be explicitly imported.

For example, to load a Foo instance the following code could be used:

```
ServiceLoader<Foo> sl =
    ServiceLoader.load( Foo.class );
Iterator<Foo> it = sl.iterator();
if ( it.hasNext() ) {
    Foo foo = it.next();
    ...
}
```

Though the Service Loader API is about extensibility and contract based programming it is in itself not extendable nor replaceable. The `ServiceLoader` class is final, it comes from a sealed JAR, and is in a java package. It also does not provide an API to provide alternate means to find implementations for a Service Type.

## 133.3 Consumers

*Consumers* are classes that are not OSGi aware and directly use the *Service Loader API*. The Service Loader has a non-modular design and Consumers therefore run into many issues when running in an OSGi framework. Consumers should therefore in general be converted to use the OSGi service layer since this solves the visibility issues, life cycle impedance mismatch, and other problems. The Consumer part of this specification is therefore a last resort to use when existing code uses the Service Loader API and cannot be modified to leverage the OSGi service layer.

### 133.3.1 Processing

The Service Loader Mediator can *process* the Consumer by modifying calls to the Service Loader API. This specification does not detail how the Mediator ensures that the Consumer has visibility to other Service Providers. However, a Mediator could for example set an appropriate Thread Context Class Loader during the call to the Service Loader's constructor by weaving the Consumer's byte codes.

### 133.3.2 Opting In

Processing is an opt-in process, the Consumer bundle must declare that it is willing to be processed. The opt-in is handled by a requirement to the `osgi.serviceloader.processor` extender. This requirement must have a single cardinality (the default) since the Mediator uses the wiring to select the Consumer to process when multiple Mediators are present.

For example, the following requirement in a manifest enables a bundle to be processed:

```
Require-Capability:
    osgi.extender;
        filter:="(&(osgi.extender=osgi.serviceloader.processor)
            (version>=1.0) (! (version>=2.0)))"
```

If the extender `osgi.serviceloader.processor` requirement is satisfied then the wired Mediator must process the Consumer.

The Mediator must give visibility to all bundles with *published* Service Providers unless the Consumer restricts the visibility by having `osgi.serviceloader` requirements. Bundles publish a Service

Type, meaning all their Service Providers for that type, by having at least one `osgi.serviceloader` capability for that Service Type.

### 133.3.3 Restricting Visibility

A Consumer's bundle can restrict its visibility to certain bundles by declaring an `osgi.serviceloader` requirement for each Service Type it wants to use. Only bundles wired from those requirement provide their advertised Service Providers. If no such requirements are declared then all bundles with the published Service Type become available.

The cardinality can be used to select a single Service Provider's bundle or multiple bundles if it needs to see all Service Provider bundles. The requirement can be made optional if the Consumer's bundle can work also when no Service Provider bundle is available. See *osgi.serviceloader Namespace* on page 921 for more details.

For example, a requirement that restricts visibility to the `org.example.Foo` Service Providers could look like:

```
Require-Capability:
  osgi.serviceloader;
  filter:="(osgi.serviceloader=org.example.Foo)";
  cardinality:=multiple
```

In this example, any bundle that publishes the `org.example.Foo` Service Type will contribute its Service Providers.

Visibility can also be restricted to bundles that publish with capability's attributes. Any bundle that has at least one matching capability will then be able to contribute all its Service Providers. For example, the following example selects only bundles that have the `classified` property set:

```
osgi.serviceloader; filter:="(classified=*)"
```

With Service Registrations, see *Registering Services* on page 918, the capability can discriminate between multiple Service Providers in the same bundle. The Service Loader API does not have this feature: any wired requirement has visibility to all Service Providers in the wired bundle, regardless of the registered directive.

### 133.3.4 Life Cycle Impedance Mismatch

A Consumer can only see Service Provider instances of bundles that are active during the time the next instance is created. That is, the Mediator must treat the life cycle of the Service Provider as if it was a service. However, the Service Loader implementations perform extensive class loader techniques and cache results. The exact life cycle of the Service Provider bundle with respect to the Consumer is therefore impossible to enforce.

The Service Loader API does not have a life cycle, objects are assumed to stay alive during the duration of the VM's process and due to the use of `Class.forName` in the Service Loader implementations. Therefore a Mediator should refresh a Consumer bundle when it is using a Service Provider and that Service Provider's bundle becomes stopped otherwise long running applications can run out of memory when bundles are regularly updated.

### 133.3.5 Consumer Example

A legacy JAR for which there is no more source code uses the Service Loader API to get access to `com.example.Codec` instances through the Service Loader API.

It is wrapped in a bundle that then has the following manifest:

```
Manifest-Version:      1.0
Bundle-ManifestVersion: 2
```

```

Bundle-SymbolicName:    com.example.impl
Bundle-Version:         23.98.1.v199101232310.02011
Import-Package:        com.example; version=3.45
Bundle-ClassPath:      legacy.jar

```

The manifest must then declare that the bundle must be processed, this is triggered by requiring the `osgi.serviceloader.processor` extender:

```

Require-Capability:
  osgi.extender;
    filter:="(&(osgi.extender=osgi.serviceloader.processor)
              (version>=1.0) (! (version>=2.0)))"

```

With this manifest, the Consumer bundle has full visibility to all Service Provider bundles that are published. The following lines can be added to restrict the visibility to codecs that have support for WAVE formats (although all Service Providers in that bundle will be visible to the consumer).

```

osgi.serviceloader;
  filter:="(&(format=WAVE) (osgi.serviceloader=com.example.Codec))"

```

## 133.4 Service Provider Bundles

A *Service Provider bundle* is a bundle that contains one or more Service Providers that are usable by the Service Loader API. This section shows how Service Provider bundles should be constructed and what options they have.

### 133.4.1 Advertising

*Service Providers* are implementation classes that are *advertised* under a Service Type according to the rules in the Service Loader API. A Service Provider is advertised with a *Provider Configuration File* in a JAR. In an OSGi environment the Service Provider must reside in the same bundle as the advertisement or be imported. A single Provider Configuration File can contain multiple Service Providers. See *Java Service Loader API* on page 913.

### 133.4.2 Publishing the Service Providers

Service Providers can be used in two different scenarios:

- A Service Provider can be used by a processed Consumer as a Service Type, or
- It can be registered as a service.

A Service Type must be *published* to allow its use in these scenarios. Publishing a Service Type consists of providing one or more `osgi.serviceloader` capabilities for an advertised Service Type, see *osgi.serviceloader Namespace* on page 921. These `osgi.serviceloader` capabilities must specify a fully qualified class name of the Service Type, there is no wildcarding allowed. Therefore, publishing a service implicitly makes all corresponding Service Providers available to Consumers.

If a bundle does not provide `osgi.serviceloader` capabilities then it does not publish any Service Providers and its Service Providers can therefore not be used by Consumers. They can then also not be registered as OSGi services, see *OSGi Services* on page 917. Tools can use the advertisement of the Service Provider in the JAR to automatically generate the `osgi.serviceloader` capabilities in the manifest.

For example, the following capability publishes all the Service Providers in its bundle that advertise the `com.example.Codec` interface:



```
Provide-Capability:
  osgi.serviceloader;
  osgi.serviceloader=com.example.Codec;
  uses:="com.example"
```

A Service Provider bundle must not require the `osgi.serviceloader.processor` extender unless it needs to be processed; publishing a Service Type is sufficient to allow Consumers to use the published Service Types.

### 133-4.3 OSGi Services

The Service Provider can have its `osgi.serviceloader` capabilities be registered as services that provide instances from the Service Providers. For this, the Service Provider bundle must require the `osgi.serviceloader.registrar` extender, which is the Mediator. For example:

```
Require-Capability:
  osgi.extender;
  filter:="(&(osgi.extender=osgi.serviceloader.registrar)
  (version>=1.0) (! (version>=2.0)))"
```

The registrar must then inspect each `osgi.serviceloader` capability and register an associated OSGi Service for each Service Provider *selected* by that capability. A Service Provider is selected when:

- The capability has no `register` directive, or
- The `register` directive matches the fully qualified name of the Service Provider.

A `register` directive selects a Service Provider if it contains the fully qualified name of the Service Provider, that is, the implementation class. Selection only works for services, Consumer will always see all Service Providers regardless of the `register` directive due to limitations in the Service Loader API.

For example, the following manifest selects all Service Providers of the `com.example.Foo` Service Type since no `register` directive is present:

```
Provide-Capability:
  osgi.serviceloader;
  uses:="com.example";
  osgi.serviceloader=com.example.Foo
```

Selected Service Providers must be registered as defined in *Registering Services* on page 918, with the capability's attributes as *decorating* service properties. Private service properties (attributes that start with a full stop (`!` \u002E)) and the defined capability attributes in the `osgi.serviceloader` namespace are not registered as service properties.

The following example would register the `format` service property but not the `.hint` service property for the `com.acme.impl.WaveFoo` Service Provider.

```
osgi.serviceloader;
  osgi.serviceloader=com.example.Foo;
  uses:="com.example";
  format=WAVE;
  .hint=E5437Qy7;
  register:="com.acme.impl.WaveFoo"
```

The Mediator must only register OSGi services for selected Service Providers; the Service Provider bundle can therefore decide not to register certain Service Providers and register them with another mechanism, for example Declarative Services or in a bundle activator.

Since the Mediator must use the bundle context of the Service Provider to register the OSGi service the Service Provider bundle must have the proper Service Permission REGISTER for the Service Type.

### 133.4.4 Service Provider Example

A Foo Codecs JAR needs to be ported to OSGi, it provides a Service Provider for the `org.example.Codec` Service Type. In this example the JAR is given a new manifest:

```
Manifest-Version:      1.0
Bundle-ManifestVersion: 2
Bundle-SymbolicName:  com.example.foo.codecs
Import-Package:       com.example; version=3.45
```

To ensure that the bundle opts in to registering its services it must require the `osgi.serviceloader.registrar` extender.

```
Require-Capability:
  osgi.extender;
    filter:="(&(osgi.extender=osgi.serviceloader.registrar)
            (version>=1.0) (! (version>=2.0)))"
```

To publish two Service Providers for the same type, two capabilities must be declared:

```
Provide-Capability:
  osgi.serviceloader;
    osgi.serviceloader="com.example.Codec";
    format:List<String>="WAVE,WMF";
    register:="com.acme.impl.FooWaveCodec";
    uses:="com.example,org.apache.common.codecs";
  osgi.serviceloader;
    osgi.serviceloader="com.example.Codec";
    format:List<String>="SINUS";
    register:="com.acme.impl.sinus.FooSinusCodec";
    uses:="com.example"
```

This example implicitly publishes the Service Type `com.example.Codec` multiple times with different attributes. Consumers that match any of these capabilities will however have visibility to all Service Providers since the Service Loader API cannot discriminate between different Service Providers from the same bundle.

## 133.5 Service Loader Mediator

A Mediator is the `osgi.serviceloader.processor` and `osgi.serviceloader.registrar` extender bundle that has the following responsibilities:

- It registers selected Service Providers as OSGi services.
- It processes any Consumers so that Service Loader API calls have proper visibility to published Service Provider bundles.

### 133.5.1 Registering Services

The Mediator must track bundles that are wired to its `osgi.extender=osgi.serviceloader.registrar` capability. These are called the *managed* bundles. For all managed bundles the Mediator must enumerate all `osgi.serviceloader` capabilities and register *selected* Service Providers as OSGi services. A Service Provider is selected by an `osgi.serviceloader` capability when:

- The advertised Service Type matches the corresponding `osgi.serviceloader` capability's Service Type, and
- The register directive is absent, or
  - The register directive contains the fully qualified name of the Service Provider.

An `osgi.serviceloader` capability that selects a Service Provider is said to *decorate* that Service Provider. A capability can decorate multiple Service Providers of the same Service Type and the same Service Provider can be decorated by different capabilities. Figure 133.2 depicts the resulting relations and their cardinalities since the relations are non-trivial.

Figure 133.2

Cardinality Service Type

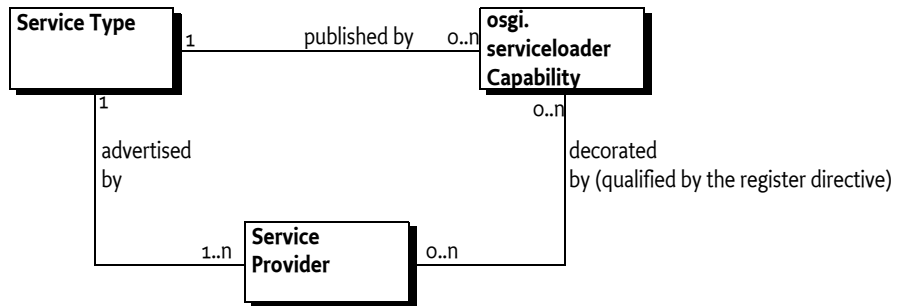

The OSGi service for each selected Service Provider must be registered under the advertised Service Type of the Service Provider, which must match the Service Type specified in the capability.

### 133.5.2

## OSGi Service Factory

The Mediator must register an OSGi service factory with the bundle context of the Service Provider's bundle. The OSGi service factory must be implemented such that it creates a new instance for each bundle that gets the service. This behavior is similar, though not quite identical, to the `ServiceLoader.load()` method that gives each consumer a separate instance of the service. The difference is that different users inside a bundle will share the same instance.

Each service registration is controlled by a decorating `osgi.serviceloader` capability. The attributes on this capability must be registered with the OSGi service as service properties, except for:

- *Private* - Private properties, property names that start with a full stop (`' \u002E`) must not be registered.

The following service property must be registered, overriding any identical named properties in the decorating capability:

- `serviceloader.mediator` - (Long) The bundle id of the mediator.

The Mediator should not verify class space consistency since the OSGi framework already enforces this as long as the publishing capability specifies the `uses` directive.

Any services registered in the OSGi Service Registry must be unregistered when the Service Provider's bundle is stopped or the Mediator is stopped.

### 133.5.3

## Service Loader and Modularity

The Service Loader API causes issues in a modular environment because it requires a class loader that has wide visibility. In a modular environment like OSGi the Consumer, the Service Type, and the Service Provider can, and should, all reside in different modules because they represent different concerns. Best practice requires that only the Service Type is shared between these actors. However,

for the Service Loader to work as it was designed the Consumer must provide a class loader that has visibility of the Service Provider. The Service Provider is an implementation class, exporting such classes is the anathema of modularity. However, since the standard JRE provides application wide visibility this was never a major concern.

The simplest solution is to make the Service Loader aware of OSGi, its API clear is mappable to the OSGi service layer. However, the Service Loader is not extensible. The result is that using the Service Loader in OSGi fails in general because the Service Loader is unable to find the Service Providers. The issues are:

- The use of the Thread Context Class Loader (TCCL) is not defined in an OSGi environment. It should be set by the caller and this cannot be enforced. The multi threaded nature of OSGi makes it hard to predict what thread a Consumer will use, making it impossible to set an appropriate TCCL outside the Consumer.
- A bundle cannot import META-INF/services since the name is not a package name. Even if it could, the OSGi framework can only bind a single exporter to an importer for a given package. The Service Loader API requires access to all these pseudo-packages via the Class Loader's `getResources` method, the technique used to find Service Providers.
- Instantiating a Service Provider requires access to internal implementation classes, by exporting these classes, an implementing bundle would break its encapsulation.
- If a Service Provider was exported then importing this class in a Consumer bundle would couple it to a specific implementation package; this also violates the principle of loose coupling.
- The Service Loader API does assume an eternal life cycle, there is no way to signal that a Service Provider is no longer available. This is at odds with the dynamic bundle life cycle.

#### 133-5.4 Processing Consumers

Consumers are not written for OSGi and require help to successfully use the Service Loader API. It is the Mediator's responsibility to ensure that bundles that are wired to published Service Types have access to these Service Provider's instances through the Service Loader API.

This specification does not define how this is done. There are a number of possibilities and it is up to the Mediator to provide the guarantee to the Consumer that it has been properly processed.

A Mediator must only process Consumer's bundles that are wired to the `osgi.extender` capability for the `osgi.serviceloader.processor` extender. Since Consumers must require this extender capability with the default cardinality of 1 there can at most be one extender wired to a Consumer.

#### 133-5.5 Visibility

The Mediator must process the Consumer bundle in such a way that when the Consumer uses the Service Loader API it receives all the Service Providers of bundles that:

- Provide one or more `osgi.serviceloader` capabilities for the requested Service Type, and
- Are not type space incompatible with the requester for the given Service Type, and
- Either the Consumer has no `osgi.serviceloader` requirements or one of its requirements is wired to one of the `osgi.serviceloader` capabilities.

The Mediator must verify that the Consumer has Service Permission GET for the given Service Type since the Consumer uses the Service Type as a service. This specification therefore reuses the Service Permission for this purpose. The check must be done with the `ServicePermission(String,String)` constructor using the bundle's Access Control Context or the bundle's `hasPermission` method.

#### 133-5.6 Life Cycle

There is a life cycle mismatch between the Service Loader API and the dynamic OSGi world. A Service Loader provides a Consumer with an object that could come from a bundle that is later stopped

and/or refreshed. Such an object becomes *stale*. Mediators should attempt to refresh bundles that have access to these stale objects.

## 133.6 osgi.serviceloader Namespace

The `osgi.serviceloader` Namespace:

- Allows the Consumer's bundle to require the presence of a Service Provider for the required Service Type.
- Provides the service properties for the service registration.
- Indicates which Service Providers should be registered as an OSGi service.

The namespace is defined in the following table and [ServiceLoaderNamespace](#), see *Common Namespaces Specification* on page 993 for the legend of this table.

Table 133.1 *osgi.serviceloader namespace definition*

Name	Kind	M/O	Type	Syntax	Description
<code>osgi.serviceloader</code>	CA	M	String	qname	The Service Type's fully qualified name.
*	CA	O	*	*	Additional matching attributes are permitted. These attributes will be registered as custom service properties unless they are private (start with a full stop).
<code>register</code>	CD	O	String	qname	Use this capability to register a different Service Factory under the Service Type for each selected Service Provider.  A Service Provider is selected if the Service Type is the advertising Service Type and the Service Provider's fully qualified name matches the given name. If no register directive is present all advertised Service Providers must be registered. To register no Service Providers, because the capability must only be used to publish, provide an empty string.

## 133.7 Use of the osgi.extender Namespace

This section specifies the extender names for Mediators. They are used by both by Consumer and Service Provider bundles to ensure that a Mediator is present. Both names are defined for the general `osgi.extender` namespace in *osgi.extender Namespace* in *OSGi Core Release 6*.

The `osgi.extender` namespace requires the use of an *extender name*, the name of the Mediator extenders is:

```
osgi.serviceloader.processor
osgi.serviceloader.registrar
```

The version is for this specification is in both cases:

```
1.0.0
```

## 133.8 Security

### 133.8.1 Mediator

The Mediator will require significant permissions to perform its tasks. First, it will require access to the Bundle Context of the Service Provider bundle, which means it must have Admin Permission:

```
AdminPermission[<Service Provider Bundles>,CONTEXT|METADATA|CLASS]
```

Since it will have to register on behalf of the Service Provider bundle it must have complete liberty to register services:

```
ServicePermission[<Service Type>,REGISTER]
```

Depending on the way the Consumers are processed additional requirements may be necessary.

The Mediator connects two parties; it must ensure that neither party will receive additional permissions.

### 133.8.2 Consumers

Consumers must have:

```
ServicePermission[<Service Type>,GET]
PackagePermission[<Service Type's package>,IMPORT]
CapabilityPermission["osgi.extender", REQUIRE]
CapabilityPermission["osgi.serviceloader", REQUIRE]
```

The Mediator must ensure that the Consumer has the ServicePermission before it provides the instance. It must use the Bundle Context hasPermission method or the bundle's Access Control Context to verify this.

### 133.8.3 Service Providers

Service Providers must have:

```
ServicePermission[<Service Type>,REGISTER]
PackagePermission[<Service Type's package>,IMPORT]
CapabilityPermission["osgi.extender", REQUIRE]
CapabilityPermission["osgi.serviceloader", PROVIDE]
```

The Mediator must ensure that the Service Provider has the ServicePermission before it provides the instance. It must use the Bundle Context hasPermission method or the bundle's Access Control Context to verify this.

## 133.9 org.osgi.service.serviceloader

Service Loader Mediator Package Version 1.0.

Bundles wishing to use this package must list the package in the Import-Package header of the bundle's manifest. This package has two types of users: the consumers that use the API in this package and the providers that implement the API in this package.

Example import for consumers using the API in this package:

```
Import-Package: org.osgi.service.serviceloader; version="[1.0,2.0)"
```

Example import for providers implementing the API in this package:

```
Import-Package: org.osgi.service.serviceloader; version="[1.0,1.1]"
```

### 133.9.1 Summary

- `ServiceLoaderNamespace` - Service Loader Capability and Requirement Namespace.

### 133.9.2 **public final class ServiceLoaderNamespace** **extends Namespace**

Service Loader Capability and Requirement Namespace.

This class defines the names for the attributes and directives for this namespace.

All unspecified capability attributes are of one of the following types:

- `String`
- `Version`
- `Long`
- `Double`
- `List<String>`
- `List<Version>`
- `List<Long>`
- `List<Double>`

and are used as arbitrary matching attributes for the capability. The values associated with the specified directive and attribute keys are of type `String`, unless otherwise indicated.

All unspecified capability attributes, unless the attribute name starts with full stop (`!\u002E`), are also used as service properties when registering a Service Provider as a service.

*Concurrency* Immutable

#### 133.9.2.1 **public static final String CAPABILITY\_REGISTER\_DIRECTIVE = "register"**

The capability directive used to specify the implementation classes of the service. The value of this attribute must be of type `List<String>`.

If this directive is not specified, then all advertised Service Providers that match the service type name must be registered. If this directive is specified, then only Service Providers that match the service type name whose implementation class is contained in the value of this attribute must be registered. To not register a service for this capability use an empty string.

#### 133.9.2.2 **public static final String SERVICELOADER\_NAMESPACE = "osgi.serviceloader"**

Namespace name for service loader capabilities and requirements.

Also, the capability attribute used to specify the fully qualified name of the service type.

## 133.10 References

- [1] *Java Service Loader API*  
<http://docs.oracle.com/javase/6/docs/api/java/util/ServiceLoader.html>





# 134 Subsystem Service Specification

## Version 1.1

### 134.1 Introduction

The *OSGi Core Release 6* specifies a life-cycle model where bundles can be installed, resolved, and started in order to provide their own classes and services as well as use those provided by other bundles in the system. In the core framework, the bundle is the coarsest deployment unit that a management agent is able to work with; however, oftentimes it is necessary to work with collections of bundles and other types of *resources*, such as subsystems and implementation specific resources. For example, a collection of bundles may correspond to a particular feature of a middleware product, such as a Web container. The applications deployed to that container may also be developed as a collection of bundles that an administrator is required to manage as a consistent whole. The Subsystems specification provides a declarative model for defining resource collections, including bundles, and an API for installing and managing those collections of resources.

Many use cases only require *unscoped* resource collections where all provided capabilities are freely exported to and all required capabilities are freely imported from the system. However, in some cases, it is important to allow the exporting of provided capabilities to be *scoped* such that they can only be used by a subset of resources in the system. It may also be necessary to restrict the importing of required capabilities from outside the collection to ensure its internal capabilities are always preferred over capabilities outside the collection. For example, applications running on a Web application server or in a cloud environment may be deployed to the same server instance. The side-effects of co-locating applications on the same server must be minimized, and scoping is used to ensure each application does not use the classes and services of the others.

The framework provides hooks for influencing resolution, and access to bundles and services. These framework hooks may be used to implement scoping for a collection of bundles. The Subsystems specification provides a higher-level declarative model for defining scoping for collections of resources, including bundles.

When deploying a collection of bundles in an OSGi framework, gaps can exist between the requirements of the bundles and the capabilities provided by the target runtime. Management agents are responsible for ensuring additional bundles are installed to plug these gaps such that the collection of bundles will resolve and run. The *Resolver Service Specification* on page 1003 and *Repository Service Specification* on page 889 help management agents address these needs but do not cover how deployment works for resource collections, especially when those collections are scoped. Scoping affects requirement and capability resolution and therefore affects the choice of resources. The Subsystems specification defines resolution and provisioning rules to help management agents consistently deploy collections of resources. The specification also defines a format for developers and testers to provide predetermined deployment resolutions to help ensure consistency between test and production environments.

#### 134.1.1 Essentials

- *Collections* - Allow the management of a collection of resources as a whole.
- *Scoping* - Provide support for isolating resources in the collection such that a subset of their capabilities (for example packages and services) are available to satisfy requirements outside the Sub-

system and a subset of their requirements are able to resolve to capabilities provided outside the Subsystem.

- *Sharing* - Allow Scoped Subsystems to share their resources with others and share resources from others.
- *Dynamic* - Provide life cycle information to users of Subsystems and be able to react to changes in the state of the environment in which a Subsystem is deployed.
- *Flexible* - Enable a flexible definition with subsequent resolution to determine the resources to be used.
- *Deterministic* - Enable the choice of resources deployed for a Subsystem to be determined ahead of deployment.
- *Life-cycle* - Define a life cycle for a Subsystem describing how it affects the Subsystem's resources and allow the life cycle to be observed.
- *Reflective* - Allow discovery of runtime structural and state information.
- *Resolution* - Allow the resolution of a flexible definition during installation to determine the resources to be used.
- *Recursive* - Allow Subsystems to be defined in terms of other Subsystems.

### 134.1.2

## Entities

- *Subsystem* - A collection of resources, such as bundles, or other Subsystems, administered as a whole through a Subsystem service.
- *Subsystem Manifest* - A manifest used to provide a Subsystem definition.
- *Deployment Manifest* - A manifest used to provide a deployment definition for a Subsystem. The definition identifies the exact resources to be deployed for the Subsystem.
- *Subsystem Archive* - A zip file with an .esa extension that describes a Subsystem definition. It may include the Subsystem Manifest, Deployment Manifest, or resource files that constitute the Subsystem.
- *Resource* - An element which may be used in the composition of a Subsystem, such as a bundle or another Subsystem.
- *Repository* - A service that is used to discover a Subsystem's content and dependencies. The repository service is described in the *Repository Service Specification* on page 889.
- *Resolver* - A service used to resolve requirements against capabilities to determine the resources required by a Subsystem. The resolver service is described in the *Resolver Service Specification* on page 1003.
- *Constituent* - A resource that belongs to one or more Subsystems.

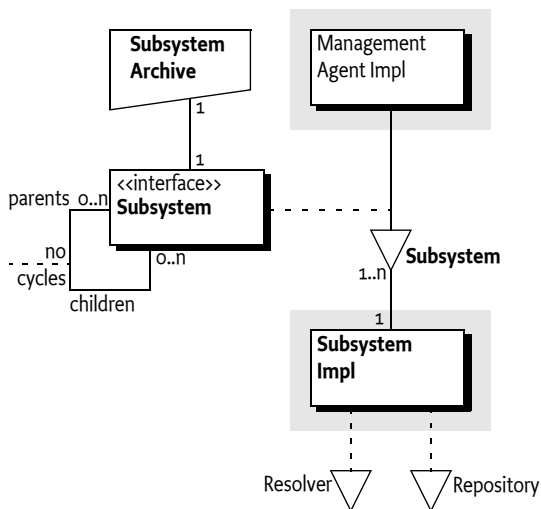
Figure 134.1 Entities *org.osgi.service.subsystem*

### 134.1.3 Synopsis

The OSGi framework does not provide any support for managing collections of resources. Management of collections of resources is enabled by a Subsystems implementation. When a Subsystems implementation is installed into the framework, it registers a Subsystem service. This service represents the framework as the *Root Subsystem*, which is a Subsystem that provides the capability to install and manage other *child Subsystems*, and is the parent of those Subsystems, but does not itself have a parent.

A Subsystem Archive provides a definition of a Subsystem that is read by the Subsystem implementation as part of installation. The Subsystem is packaged in a Subsystem Archive (.esa) file which is the Subsystem equivalent of a bundle .jar file. The Subsystem definition can be described using a Subsystem Manifest or defaulted based on the name and contents of the Subsystem Archive. Installing a new Subsystem results in another Subsystem service being registered to represent that Subsystem in the runtime. Each Subsystem service enables management and reflection of the Subsystem it represents.

A Subsystem Manifest allows flexibility in the identification of the Subsystem's content resources through version ranges and optionality. The exact versions to be deployed and any required *dependencies* (resources required to satisfy unresolved requirements of the Subsystem's content resources) can be identified in an optional Deployment Manifest. The corresponding resource binaries can be packaged in the Subsystem Archive, or found in a repository. Depending on the type of Subsystem the Subsystem Manifest may describe a *sharing policy* for the Subsystem, such as the packages or services the Subsystem exports or imports. The Deployment Manifest also describes the *sharing policy* details for the Subsystem and is defined by the type of Subsystem and the *sharing policy* described in the Subsystem Manifest.

A Subsystem that does not have a Deployment Manifest has its deployment details calculated during installation. This may be done using the *Resolver Service Specification* on page 1003, if available. The starting set of requirements to be resolved are those identifying the Subsystem content (that is, requirements for content resources). The Subsystems implementation provides a resolve context that implements the policy for the Subsystem and consults the configured Repository services to find candidates to satisfy requirements.

This resolve context can also represent the target deployment environment, which might be a live framework, or a static definition of a target runtime. The resulting resolution is used to determine the exact resources to provision, equivalent to those identified in the deployment manifest. If any

of the Repository or Resolver services are unavailable, then a Subsystem implementation can use its own means to determine the deployment, or fail the installation.

A Subsystem definition includes sharing policy configuration to scope requirements and capabilities visibility into and out of a Subsystem. The Subsystems specification defines the concept of Subsystem types to help simplify the configuration of sharing policies. Each type has its own default sharing policy, for example, to forbid the sharing of capabilities out, or to share all capabilities in. Three Subsystem types are defined in the Subsystems specification: *application*, *composite* and *feature*.

An *Application Subsystem* is a Scoped Subsystem with a sharing policy associated with what is often considered to be an application. An application does not share (export) any capabilities. Any requirements that are not satisfied by the application's contents are automatically imported from outside the application.

A *Composite Subsystem* is a Scoped Subsystem with a fully explicit sharing policy. Capabilities may be explicitly imported into, or exported out of, the Composite Subsystem.

A *Feature Subsystem* is an Unscoped Subsystem and so all its requirements and capabilities are shared.

This specification allows for other types to be defined, including ones outside this specification.

## 134.2 Subsystems

This specification defines a unit of installation called a *Subsystem*. A Subsystem is comprised of resources, including OSGi bundles and other Subsystems, which together can provide functions to end users.

A Subsystem is deployed as a Subsystem Archive (.esa) file. Subsystem Archives are used to store Subsystems and optionally their resources in a standard ZIP-based file format. This format is defined in [4] *Zip File Format*. Subsystems normally use the Subsystem Archive extension of .esa but are not required to. However there is a special MIME type reserved for OSGi Subsystems that can be used to distinguish Subsystems from normal ZIP files. This MIME type is:

```
application/vnd.osgi.subsystem
```

The type is defined in [5] *IANA application/vnd.osgi.subsystem*. A Subsystem is a ZIP file that:

- Contains zero or more resources. These resources may be OSGi bundles or other Subsystems. Subsystems may be nested or included to any depth.
- Contains an optional Subsystem Manifest named OSGI-INF/SUBSYSTEM.MF. The Subsystem Manifest describes the contents of the Subsystem Archive and provides information about the Subsystem. The Subsystem Archive uses headers to specify information that the Subsystems implementation needs to install, resolve and start the Subsystem correctly. For example, it can state the list of content resources that comprise the Subsystem and the Subsystem's type.
- Contains an optional Deployment Manifest file named OSGI-INF/DEPLOYMENT.MF. The Deployment Manifest describes the content resources, dependencies, and sharing policy that need to be provisioned to satisfy the Subsystem definition and ultimately allow it to resolve at runtime.

The Subsystem and Deployment Manifest follow the JAR manifest format (version 1.0), but with the following relaxed rules:

- No limit on the line length. Lines are allowed to exceed the JAR manifest maximum of 72 bytes.
- The last line is not required to be a carriage-return new-line combination.
- There is only one section in the manifest (the main section). A Subsystems implementation is free to ignore other sections of the manifest.

Once a Subsystem is started, its functionality is provided. Depending on the type of Subsystem it may expose capabilities, such as packages and services, to other resources installed in the OSGi framework.

### 134.2.1 Subsystem Manifest Headers

A Subsystem can carry descriptive information about itself in the Subsystem manifest file contained in its Subsystem Archive under the name `OSGI-INF/SUBSYSTEM.MF`. This specification defines Subsystem manifest headers, such as `Subsystem-SymbolicName` and `Subsystem-Version`, which Subsystem developers use to supply descriptive information about a Subsystem. A Subsystem's implementation must:

- Process the main section of the manifest. Any other sections of the manifest can be ignored.
- Ignore unknown manifest headers. The Subsystem developer can define additional manifest headers as needed.
- Ignore unknown attributes and directives.

All specified manifest headers are listed in the following sections. All headers are optional. Example values are provided to help explain each header (e.g. `Export-Package: org.acme.logging; version=1.0`).

#### 134.2.1.1 **Export-Package: org.acme.logging; version=1.0**

The `Export-Package` header declares the exported packages for a Scoped Subsystem. See *Export-Package* on page 966.

#### 134.2.1.2 **Import-Package: org.osgi.util.tracker; version="[1.4, 2.0]"**

The `Import-Package` header declares the imported packages for a Scoped Subsystem. See *Import-Package* on page 966.

#### 134.2.1.3 **Preferred-Provider: com.acme.logging**

The `Preferred-Provider` header declares a list bundles and Subsystems which are the providers of capabilities that are preferred when wiring the requirements of a Scoped Subsystem. See *Preferred-Provider Header* on page 941.

#### 134.2.1.4 **Provide-Capability: com.acme.dict; from=nl; to=de; version:Version=1.2**

The `Provide-Capability` header declares the capabilities exported for a Scoped Subsystem. See [3] *Resource and Wiring*.

#### 134.2.1.5 **Require-Bundle: com.acme.chess; version= "[1.0, 2.0]"**

The `Require-Bundle` header declares the required bundles for a Scoped Subsystem. See *Require-Bundle* on page 967.

#### 134.2.1.6 **Require-Capability: osgi.ee; filter="(osgi.ee=\*)"**

The `Require-Capability` header declares the required capabilities for a Scoped Subsystem. See [3] *Resource and Wiring*.

#### 134.2.1.7 **Subsystem-Category: osgi, test, nursery**

The `Subsystem-Category` header identifies the categories of the subsystem as a comma-delimited list.

#### 134.2.1.8 **Subsystem-ContactAddress: 2400 Oswego Road, Austin, TX 74563**

The `Subsystem-ContactAddress` header identifies the contact address where problems with the subsystem may be reported; for example, an email address.

**134.2.1.9 Subsystem-Content: com.acme.logging**

The Subsystem-Content header lists requirements for resources that are considered to be the contents of this Subsystem. See *Subsystem-Content Header* on page 939.

**134.2.1.10 Subsystem-Copyright: OSGi (c) 2014**

The Subsystem-Copyright header identifies the subsystem's copyright information.

**134.2.1.11 Subsystem-Description: The ACME Account Admin Application**

The Subsystem-Description header defines a human-readable description for this Subsystem, which can potentially be localized.

**134.2.1.12 Subsystem-DocURL: http://www.example.com/Firewall/doc**

The Subsystem-DocURL header identifies the subsystem's documentation URL, from which further information about the subsystem may be obtained.

**134.2.1.13 Subsystem-ExportService: org.acme.billing.Account; filter:="(user=bob)"**

The Subsystem-ExportService header specifies the exported services for a Scoped Subsystem. See *Subsystem-ExportService* on page 967.

**134.2.1.14 Subsystem-Icon: /icons/acme-logo.png; size=64**

The optional Subsystem-Icon header provides a list of URLs to icons representing this subsystem in different sizes. The following attribute is permitted:

- `size` - (integer) Specifies the size of the icon in pixels horizontal. It is recommended to always include a 64x64 icon.

The URLs are interpreted as relative to the subsystem archive. That is, if a URL with a scheme is provided, then this is taken as an absolute URL. Otherwise, the path points to an entry in the subsystem archive file.

**134.2.1.15 Subsystem-ImportService: org.acme.billing.Account; filter:="(type=premium)"**

The Subsystem-ImportService header specifies the imported services for a Scoped Subsystem. See *Subsystem-ImportService* on page 967.

**134.2.1.16 Subsystem-License: http://www.opensource.org/licenses/jabberpl.php**

The Subsystem-License header provides an optional machine readable form of license information. The purpose of this header is to automate some of the license processing required by many organizations like for example license acceptance before a subsystem is used. The header is structured to provide the use of unique license naming to merge acceptance requests, as well as links to human readable information about the included licenses. This header is purely informational for management agents and must not be processed by the Subsystems implementation.

The syntax for this header is as follows:

```
Subsystem-License ::= '<<EXTERNAL>>' |
                    ( license ( ',' license ) * )
license           ::= name ( ';' license-attr ) *
license-attr     ::= description | link
description      ::= 'description' '=' string
link             ::= 'link' '=' <url>
```

This header has the following attributes:

- `name` - Provides a globally unique name for this license, preferably world wide, but it should at least be unique with respect to the other clauses. The magic name <<EXTERNAL>> is used to indi-

cate that this artifact does not contain any license information but that licensing information is provided in some other way. This is also the default contents of this header.

Clients of this subsystem can assume that licenses with the same name refer to the same license. This can for example be used to minimize the click through licenses. This name should be the canonical URL of the license, it must not be localized by the translator. This URL does not have to exist but must not be used for later versions of the license. It is recommended to use URLs from [9] *Open Source initiative*. Other licenses should use the following structure, but this is not mandated:

```
http://<domain-name>/licenses/
    <license-name>-<version>.<extension>
```

- **description** - (optional) Provide the description of the license. This is a short description that is usable in a list box on a UI to select more information about the license.
- **link** - (optional) Provide a URL to a page that defines or explains the license. If this link is absent, the name field is used for this purpose. The URL is relative to the root of the bundle. That is, it is possible to refer to a file inside the bundle.

If the Subsystem-License statement is absent, then this does not mean that the subsystem is not licensed. Licensing could be handled outside the subsystem and the <<EXTERNAL>> form should be assumed. This header is informational and may not have any legal bearing. Consult a lawyer before using this header to automate licensing processing.

#### 134.2.1.17 **Subsystem-Localization: OSGI-INF/l1on/subsystem**

The Subsystem-Localization header identifies the default base name of the localization properties files contained in the subsystem archive. The default value is OSGI-INF/l1on/subsystem. Translations are therefore, by default, OSGI-INF/l1on/subsystem\_de.properties, OSGI-INF/l1on/subsystem\_nl.properties, and so on. The location is relative to the root of the subsystem archive. See *Subsystem-Localization Header* on page 934

#### 134.2.1.18 **Subsystem-ManifestVersion: 1**

The Subsystem-ManifestVersion header defines that the Subsystem follows the rules of a Subsystems Specification. It is 1 (the default) for this version of the specification. Future versions of the Subsystems Specification can define higher numbers for this header.

#### 134.2.1.19 **Subsystem-Name: Account Application**

The Subsystem-Name header defines a short, human-readable name for this Subsystem which may be localized. This should be a short, human-readable name that can contain spaces.

#### 134.2.1.20 **Subsystem-SymbolicName: com.acme.subsystem.logging**

The Subsystem-SymbolicName header specifies a non-localizable name for this Subsystem. The Subsystem symbolic name together with a version identify a Subsystem Definition though a Subsystem can be installed multiple times in a framework. The Subsystem symbolic name should be based on the reverse domain name convention. See *Subsystem-SymbolicName Header* on page 932.

#### 134.2.1.21 **Subsystem-Type: osgi.subsystem.application**

The Subsystem-Type header specifies the type for this Subsystem. Three types of Subsystems must be supported: osgi.subsystem.application, osgi.subsystem.composite and osgi.subsystem.feature. See *Subsystem Identifiers and Type* on page 932 for details about the three different types of Subsystems. See *Subsystem-Type Header* on page 932 for more information about the values for the Subsystem-Type header.

#### 134.2.1.22 **Subsystem-Vendor: OSGi Alliance**

The Subsystem-Vendor header contains a human-readable description of the subsystem vendor.

**134.2.1.23****Subsystem-Version: 1.0**

The Subsystem-Version header specifies the version of this Subsystem. See *Subsystem-Version Header* on page 932.

**134.2.2****Subsystem Identifiers and Type**

A Subsystem is identified by a number of names that vary in their Scope:

- *Subsystem identifier* - A long that is a Subsystems implementation assigned unique identifier for the full lifetime of an installed Subsystem, even if the framework or the Subsystem's implementation is restarted. Its purpose is to distinguish Subsystems installed in a framework. Subsystem identifiers are assigned in ascending order to Subsystems when they are installed. The `getSub-systemId()` method returns a Subsystem's identifier.
- *Subsystem location* - A name assigned by a management agent to a Subsystem during the installation. This string is normally interpreted as a URL to the Subsystem Archive but this is not mandatory. Within a particular framework, a Subsystem location must be unique. A location string uniquely identifies a Subsystem. The `getLocation()` method returns a Subsystem's location.
- *Subsystem Symbolic Name and Subsystem Version* - A name and version assigned by the developer. The combination of a Subsystem symbolic name and Subsystem version is intended to provide a globally unique identifier for a Subsystem Archive or Subsystem definition. The `getSymbolic-Name()` method returns the assigned Subsystem name. The `getVersion()` method returns the assigned version. Though this pair is intended to be unique, it is developer assigned and there is no verification at runtime that the pair uniquely identifies a Subsystem Archive. It is possible to install a Subsystem multiple times as long as the multiple Subsystem symbolic name and version pairs are isolated from each other by Subsystem sharing policies.

**134.2.3****Subsystem-SymbolicName Header**

The Subsystem-SymbolicName header specifies the symbolic name of the Subsystem. The Subsystem-SymbolicName header may also specify arbitrary matching attributes. Subsystem-SymbolicName is an optional header; the default value is derived as described in *Deriving the Subsystem Identity* on page 933.

The Subsystem-SymbolicName header must conform to the following syntax:

```
Subsystem-SymbolicName ::= symbolic-name(';' parameter)*
```

No directives are defined by this specification for the Subsystem-SymbolicName header. The header allows the use of arbitrary attributes that can be required by the Subsystem-Content header.

**134.2.4****Subsystem-Version Header**

The Subsystem-Version header is optional and must conform to the following syntax:

```
Subsystem-Version ::= version
```

If the Subsystem-Version header is not specified then the default value is derived as described in *Deriving the Subsystem Identity* on page 933.

**134.2.5****Subsystem-Type Header**

The Subsystem-Type header specifies the *type* of the Subsystem. Three types of Subsystems are defined by this specification:

- `osgi.subsystem.application`
- `osgi.subsystem.composite`
- `osgi.subsystem.feature`



See *Subsystem Types* on page 968 for details about the three different types of Subsystems. Subsystem-Type is an optional header; the default value is `osgi.subsystem.application`.

The following directive must be recognized for the Subsystem-Type header:

- `provision-policy` - (`rejectDependencies`|`acceptDependencies`) Directive used to declare if the Subsystem is willing to accept dependencies as *constituents*. A *constituent* is the term used to refer to a resource that belongs to one or more Subsystems. It can belong to a Subsystem as a result of being listed as content or, as described here, can have been provisioned into the Subsystem as a dependency. The default policy is `rejectDependencies`. See *Accepting Dependencies* on page 945 for installing and tracking dependencies. The value `acceptDependencies` must not be used for Feature Subsystems. If a Feature Subsystem attempts to use the `acceptDependencies` policy then the Subsystem installation must fail. If the `provision-policy` directive is declared and has any other value besides `acceptDependencies` or `rejectDependencies` then the Subsystem installation must fail.

### 134.2.6 Deriving the Subsystem Identity

If the Subsystem-SymbolicName and Subsystem-Version are not specified, then the following rules are defined for deriving the values of the Subsystem's symbolic name and version. If not otherwise specified, the default value of the version is `o.o.o`.

When installing a Subsystem, the following URI syntax must be used as the location string in order to specify default values.

```

system-uri ::= 'system:/' url? '?' params?
params     ::= param ( '&' param )*
param      ::= key '=' value
key        ::= unreserved | escaped
value      ::= unreserved | escaped
url        ::= <see [6] RFC 1738 Uniform Resource Locators>
escaped    ::= <see [7] Uniform Resource Identifiers (URI): Generic Syntax>
unreserved ::= <see [7] Uniform Resource Identifiers (URI): Generic Syntax>

```

The query parameters represent Subsystem Manifest header names and values. Implementations must support the Subsystem-SymbolicName and Subsystem-Version parameters. Implementations can support additional parameters but must fail the installation if any unsupported parameters are included.

As an example, the following Subsystem URI has an embedded URL of:

```
http://www.foo.com/sub#system.esa
```

It includes a default symbolic name of `com.acme.foo` and default version of `1.0.0`.

```

system: //http%3A%2F%2Fwww.foo.com%2Fsub%2523system.esa? «
    Subsystem-SymbolicName=com.acme.foo&Subsystem-Version=1.0.0

```

When installing a Subsystem containing other Subsystem Archives with no symbolic name or version, values will be derived from the Subsystem Archive file or resource name. The syntax is as follows:

```
system-archive ::= symbolic-name ( '@' version ) '.esa'
```

If the symbolic name is not provided in the manifest and cannot be computed by any other means then the Subsystem must fail to install.

### 134.2.7 Subsystem Identity Capability

The Subsystem's symbolic name, version, type and the arbitrary matching attributes specified on the Subsystem-SymbolicName header compose the `osgi.identity` capability for a Subsystem re-

source. The `osgi.identity` capability is provided by a Subsystem resource when contained within a Repository service, see *Repository Service Specification* on page 889. For example:

```
Subsystem-SymbolicName: org.acme.billing;category=banking
Subsystem-Version:      1.0.0
Subsystem-Type:         osgi.subsystem.composite
```

The above headers are used to declare a Subsystem of type `osgi.subsystem.composite` with the symbolic name of `org.acme.billing`, version of `1.0.0` and arbitrary matching attribute category of `banking`. This information will also be reflected in the `osgi.identity` capability of the Subsystem's Resource (`org.osgi.resource.Resource`). The following `osgi.identity` capability would be generated for a Subsystem resource from the above headers using the Provide-Capability header syntax. For example:

```
osgi.identity;
osgi.identity=org.acme.billing;
version:Version=1.0.0;
type=osgi.subsystem.composite;
category=banking
```

This allows for requirements to be used to search a repository for Subsystems. The following requirement could be used to search for all Subsystems of type `osgi.subsystem.composite` using the Require-Capability header syntax. For example:

```
osgi.identity; filter:="(type=osgi.subsystem.composite)"
```

## 134.2.8 Subsystem-Localization Header

For consistency and ease of comprehension, the design for localizing subsystem manifest headers follows the approach used by bundles.

### 134.2.8.1 Localization Properties

A localization entry contains key/value entries for localized information. All headers in a subsystem's manifest can be localized. However, the subsystems implementation must always use the non-localized versions of headers that have subsystem semantics. Note that the use of localization on certain such headers, such as `Subsystem-SymbolicName`, may cause errors as a value with a `%` sign will not be valid.

A localization key can be specified as the value of a subsystem's manifest header using the following syntax:

```
header-value ::= '%' text
text ::= < any value which is both a valid manifest header value and a valid
        property key name >
```

For example, consider the following subsystem manifest entries:

```
Subsystem-Name: %acme subsystem
Subsystem-Description: %acme description
Subsystem-SymbolicName: acme.Subsystem
Acme-Defined-Header: %acme special header
```

User-defined headers can also be localized. Spaces in the localization keys are explicitly allowed.

The previous example manifest entries could be localized by the following entries in the manifest localization entry `OSGI-INF/l1on/subsystem.properties`.

```
# subsystem.properties
acme\ subsystem=The ACME Subsystem
acme\ description=The ACME Subsystem provides all of the ACME \ services
```

```
acme\ special\ header=user-defined Acme Data
```

The above manifest entries could also have French localizations in the manifest localization entry:

```
OSGI-INF/l10n/subsystem_fr_FR.properties.
```

### 134.2.8.2 Locating Localization Entries

The Subsystems implementation must search for localization entries by appending suffixes to the localization base name according to a specified locale and finally appending the `.properties` suffix. If a translation is not found, the locale must be made more generic by first removing the variant, then the country and finally the language until an entry is found that contains a valid translation. For example, looking up a translation for the locale `en_GB_welsh` will search in the following order:

```
OSGI-INF/l10n/subsystem_en_GB_welsh.properties
OSGI-INF/l10n/subsystem_en_GB.properties
OSGI-INF/l10n/subsystem_en.properties
OSGI-INF/l10n/subsystem.properties
```

## 134.3 Subsystem Region

A *Region* provides isolation for a group of one or more Subsystems. Each Subsystem installed must be a member of one and only one Region. A Region consists of one and only one Scoped Subsystem and optionally a set of Unscoped Subsystems. Every Region has one and only one Parent Region, with the exception of the Root Region which has no Parent Region. The Region parent  $\rightarrow$  child connections form the *Region Tree*, which by definition contains no cycles.

Each Region, except the Root Region, has a *sharing policy* associated with it which is defined by a Scoped Subsystem. A *sharing policy* consists of two parts:

- *Export Policy* - Defines the set of capabilities provided by the constituents contained in the Region that are made available to the parent Region.
- *Import Policy* - Defines the set of capabilities which are available in the parent Region that are made available to the child Region.

Figure 134.2 illustrates a set of Regions that contain capabilities and requirements for a capability. For the purposes of this illustration the Subsystems and resources have been omitted.

Figure 134.2

*Regions and Import/Export*

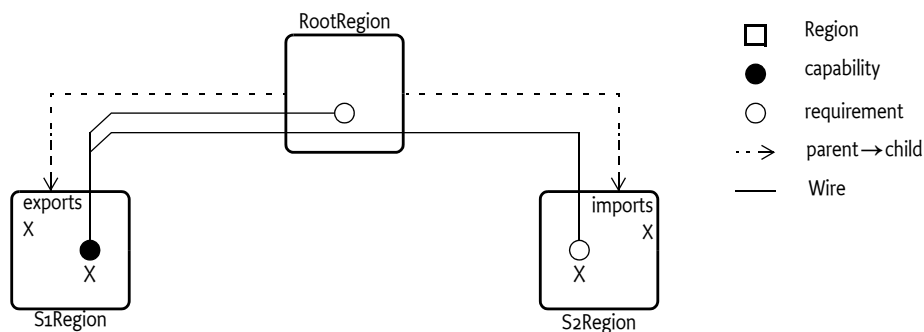

In this example some constituent of Region `S1Region` provide a capability `S1→X`. The `S1Region`'s sharing policy exports the capability `S1→X` to its parent `RootRegion`. The `RootRegion` contains a constituent which has a requirement `Root→X`. The export sharing policy of `S1Region` allows visibility to the capability `S1→X` from the `RootRegion` which allows requirement `Root→X` to be satisfied by the capability `S1→X`. The `S2Region` also contains a constituent which has a requirement on `S2→X`.

The sharing policy of `S2Region` imports the capability `X` from its parent Region `RootRegion`. Since `RootRegion` has visibility to the capability `S1→X` this allows `S2Region` to also have visibility to capability `S1→X` through its import sharing policy which allows requirement `S2→X` to be satisfied by the capability `S1→X`.

Sharing policies of the Regions allow for a capability to be shared across an arbitrary number of Regions. For those familiar with the Region digraph, see [8] *Equinox Region Digraph*, the connections between Subsystem Regions is more restrictive than what the full Region digraph specification allows. A *visibility path* is the path over the sharing policies of the Region tree from a requirement to a capability that allows a requirement to get wired to a capability. Since all (non-Root) Regions have one and only one Parent Region the *visibility paths* over the sharing policies between a requirement and a capability is limited to 0 or 1. Figure 134.3 is another figure that illustrates a capability being shared across many different Regions.

Figure 134.3 *Regions and Sharing Capabilities*

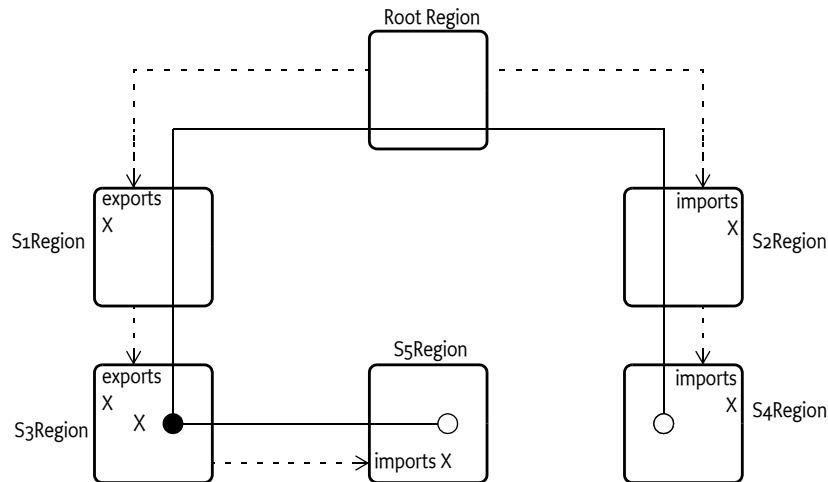

In this example the capability `S3→X` is exported by the `S3Region` sharing policy to its parent `S1Region`. `S1Region` also exports `X` to its parent `RootRegion`. Then `S2Region` imports `X` from its parent `RootRegion` and finally `S4Region` imports `X` from its parent `S2Region`. The visibility path from requirement `S4→X` to capability `S3→X` is the following: `S4→S2→Root→S1→S3`.

Notice that in this example the `S5Region` also has a sharing policy that imports `X` from its parent `S3Region`. Child Regions are allowed to import any capability to which the Parent Region has visibility. This is true even if the Parent Region does not export the capability. Regions can selectively choose what capabilities they want to expose (or export) to their Parent Region. Child Regions also can selectively choose what capabilities they want to be exposed to (or import) from their Parent Region. A Parent Region has no control over what capabilities its children have visibility. Similarly a Parent Region has no control over what capabilities a Child Region is allowed to export to the Parent Region. In other words, a Parent Region must give a Child Region everything the Child Region asks for (if the Parent Region has access to it) and a Parent Region must accept everything a Child Region offers to the Parent Region.

## 134.4 Subsystem Relationships

Subsystems installed into a framework become part of the *Subsystem graph*. The Subsystem graph may be thought of as a directed acyclic graph with one and only one source vertex, which is the Root Subsystem. The edges have the child as the head and parent as the tail (parent→child). This is depicted in Figure 134.4.

Figure 134.4 Parent Child Relationship

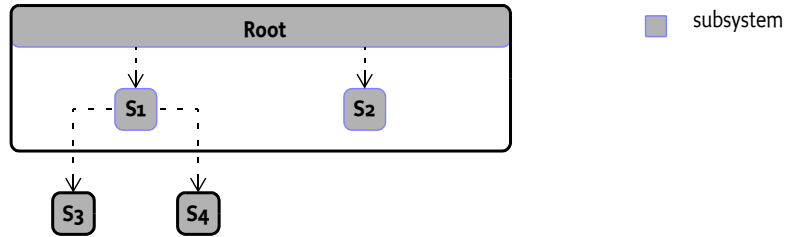

A Subsystem installed into or included within one or more Subsystems is called a *child Subsystem*. A Subsystem which has one or more child Subsystem(s) installed or included in it is called a *parent Subsystem*. Note that a Subsystem may be both a parent and child Subsystem. The Subsystem graph has the following rules:

- There is one and only one source vertex (i.e. a Subsystem with no parents), which is the *Root Subsystem*.
- The Root Subsystem is considered a Scoped Subsystem of type application with a provision-policy of acceptDependencies.
- The Root Subsystem has a symbolic name of org.osgi.service.subsystem.root, version 1.0.0, Subsystem identifier of 0, and a location of

```

system: //?Subsystem-SymbolicName=org.osgi.service.subsystem.root& «
Subsystem-Version=1.0.0

```

- The Root Subsystem always exists when a Subsystems implementation is active, even if no other Subsystems are installed and all initial bundles installed into the framework along with the Subsystems implementation are considered content resources of the Root Subsystem.
- All other (non-root) Subsystems must have one or more parent Subsystems. This implies that there are no orphan Subsystems (except the Root Subsystem) and the Subsystem graph is fully connected.
- All parents of a Subsystem belong to the same Region.
- An Unscoped Subsystem must belong to the same Region to which its parents belong.
- A Scoped Subsystem (other than the Root Subsystem) must belong to a child Region of the Region to which the Subsystem's parents belong.

When a Subsystem is installed using a Subsystem service [install\(String\)](#) or [install\(String,InputStream\)](#) method the *Subsystem resource* becomes a constituent of the Subsystem which the install method was called on. The *Subsystem resource* is the Subsystem Archive and may be retrieved by calling the Subsystem service [getConstituents\(\)](#) method. Figure 134.4 illustrates the Root Subsystem with initial bundles A, B, SI (Subsystems implementation, may be multiple bundles), and the system bundle (identifier 0).

Figure 134.5 Subsystem resources



In Figure 134.5 Bundles A, B and SI are considered constituents of the Root Subsystem. The system bundle is also considered to be a constituent of the Root Subsystem (bundle zero). A Subsystem ser-

vice R is registered that represents the Root Subsystem. When Subsystems are installed using the Root Subsystem then these Subsystem resources become constituents of the Root Subsystem and the Subsystems become child Subsystems of the Root Subsystem. For example, Figure 134.6 illustrates the Root Subsystem with Scoped Subsystem S1 with constituent bundles C and D and Scoped Subsystem S2 with constituent bundles E and F:

Figure 134.6 Subsystems

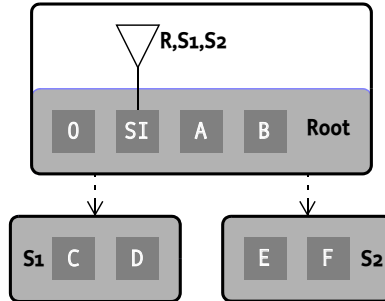

The two Subsystems S1 and S2 have the same parent and Subsystems S1 and S2 are children of the Root Subsystem. Figure 134.7 shows a more complicated tree that has both Scoped and Unscoped Subsystems installed. This figure omits the constituent resources and Subsystem services:

Figure 134.7 Parent Child Relationship with Unscoped Subsystems

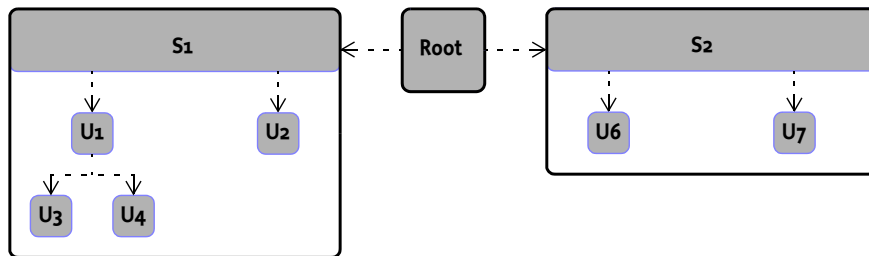

### 134.4.1 Prevent Cycles and Recursion

It is possible to end up with cycles in the parent → child relationships between Subsystems contained in the same Region. Figure 134.8 illustrates this.

Figure 134.8 Subsystems and cycles

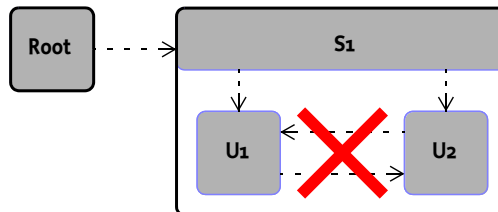

In this example Subsystem S1 has been installed. The Scoped Subsystem S1 has included in its constituents the Unscoped Subsystems U1 and U2. Furthermore U1 has included the Unscoped Subsystem U2 as a constituent and U2 has included the Unscoped Subsystem U1 as a constituent. This causes Unscoped Subsystem U1 to have parents S1 and U2 and Unscoped Subsystem U2 to have parents S1 and U1. There is now a cycle between the Subsystems U1 and U2. Subsystems implementations must detect this cycle and fail the installation of such a degenerative Subsystem. The top level Subsystem being installed must fail the install operation by throwing a Subsystem Exception. In this case the install operation of the S1 Subsystem must fail with a Subsystem Exception being thrown.

Cycles may also exist in the definition of Scoped Subsystems which includes other child Subsystems. Figure 134.9 illustrates this.

Figure 134.9 *Scoped Subsystems and cycles*

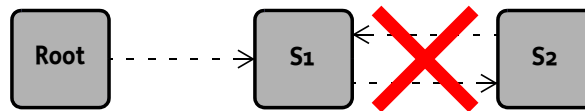

In this example the Scoped Subsystem S1 includes as a child the Scoped Subsystem S2. The S2 Subsystem also includes as a child the Scoped Subsystem S1. Subsystems implementations must detect this and fail the installation of such a degenerative Subsystem. The top level Subsystem being installed must fail the install operation by throwing a Subsystem Exception. In this case the install operation of the first S1 Subsystem must fail by throwing a Subsystem Exception.

## 134.5 Determining Content

A Subsystem definition may declare different types of *content resources*. A Subsystems implementation may support additional types, but the following types must be supported:

- `osgi.bundle`
- `osgi.fragment`
- `osgi.subsystem.application`
- `osgi.subsystem.feature`
- `osgi.subsystem.composite`

A Subsystems implementation is free to support additional content types as value-add, but an implementation is required to fail the installation of a Subsystem which declares content resource types which are not recognized by the implementation.

The individual content resources may be specified in the following ways:

- The Subsystem-Content header, or
- The entries of the Subsystem Local Repository, see *Resource Repositories* on page 942.

### 134.5.1 Subsystem-Content Header

The Subsystem-Content header contains a list of symbolic names, with optional attribute and directive assertions. Each element specifies a single resource that is to be a content resource of the Subsystem. See also *Discovering Content Resources* on page 943. The Subsystem-Content header must conform to the following syntax:

```

Subsystem-Content ::= resource ( ' , ' resource ) *
resource           ::= symbolic-name ( ' ; ' parameter ) *
  
```

The Subsystem-Content header may specify the following directives:

- `resolution` - (mandatory|optional) A mandatory content resource prevents the Subsystem from successfully installing when the constituent cannot be found (or satisfied); an optional content resource allows a Subsystem to successfully install even if the content cannot be found (or satisfied). The default value is mandatory.
- `start-order` - (Integer >= 1) Specifies the start order of the content resource in relation to other content resources of the Subsystem. See *Start Order* on page 953.

The Subsystem-Content header may specify the following architected matching attributes as well as any arbitrary matching attributes:

- `version` - (Version) A version range used to select the version of the resource to use. This follows the OSGi version range scheme, including the default value of 0.0.0.
- `type` - Indicates the type of the content. It is recommended that a reverse domain name convention is used unless those types and their processing is standardized by the OSGi Alliance, for example bundles. The default type is `osgi.bundle`. A Subsystems implementation may support additional types, but the following types must be supported:
  - `osgi.bundle`
  - `osgi.fragment`
  - `osgi.subsystem.application`
  - `osgi.subsystem.composite`
  - `osgi.subsystem.feature`

For example, the following header specifies three Subsystem constituents:

```
Subsystem-Content:
  org.acme.billing.impl;
    type=osgi.bundle;
    version=1.0,
  org.acme.billing.frag;
    type=osgi.fragment;
    version=1.0,
  org.acme.billing.credit.subsystem;
    type=osgi.subsystem.composite;
    version=1.0
```

The above header specifies three content resources of a Subsystem:

- A bundle resource with the symbolic name `org.acme.billing.impl` at version 1.0 or greater
- A fragment resource with the symbolic name `org.acme.billing.frag` at version 1.0 or greater
- A child composite Subsystem resource with the symbolic name `org.acme.billing.credit.subsystem` at version 1.0 or greater

## 134.5.2 Subsystem-Content Requirements

Each element of the Subsystem-Content header is used to locate a resource that is to be used as content of the Subsystem. One way of describing the elements of the Subsystem-Content header is in terms of a Requirement using the `osgi.identity` namespace. The Requirement is defined in [3] *Resource and Wiring*. To illustrate, a single Subsystem-Content element:

```
org.acme.billing.impl;
  type=osgi.bundle;
  version=1.0
```

This Subsystem-Content header can be converted into the following `osgi.identity` Requirement with the Require-Capability syntax for illustration:

```
osgi.identity;
  filter="(&
    (osgi.identity=org.acme.billing.impl)
    (type=osgi.bundle)
    (version>=1.0)
  )"

```

All directives specified on the Subsystem-Content header, except `start-order`, should be included in the Requirement. All attributes should be included in the filter directive of the Requirement. Notice that the version attribute is a range and must be converted into a proper filter. The



VersionRange.toFilter method can be used to do this conversion. All other matching attributes are treated as type String and use an equality operation in the filter. Here is an example of a more complex transformation to Requirement:

```
org.acme.billing.credit.subsystem;
  type=osgi.subsystem.composite;
  version="[1.0, 1.1)";
  category=banking;
  resolution:=optional;
  start-order:=1
```

The above Subsystem-Content element converts into the following osgi.identity Requirement:

```
osgi.identity;
  filter:="(&
    (osgi.identity=org.acme.billing.impl)
    (type=osgi.subsystem.composite)
    (&(version>=1.0)!(version>=1.1))
    (category=banking)
  )"
  resolution:=optional
```

### 134.5.3 Preferred-Provider Header

The Preferred-Provider header contains a list of symbolic names, with optional attributes assertions. Each element specifies a single bundle or Subsystem resource that is to be preferred when resolving the requirements of the Subsystem content resources. The Preferred-Provider header must conform to the following syntax:

```
Preferred-Provider ::= resource (',' resource)*
resource           ::= symbolic-name ( ';' attribute)*
```

The Preferred-Provider header may specify the following architected matching attributes:

- version - (Version) A version range used to select the version of the bundle or Subsystem to use. This follows the OSGi version range scheme, including the default value of 0.0.0.
- type - (String) Indicates the type of the provider. Valid types are:
  - osgi.bundle
  - osgi.subsystem.composite
  - osgi.subsystem.feature

The default type is osgi.subsystem.composite. Specifying an unsupported type results in an installation failure.

Each element of the Preferred-Provider header is used to locate a resource that is to be used as a preferred provider of the Subsystem. The Preferred-Provider header elements are converted to Requirements using the osgi.identity namespace just like the Subsystem-Content header except the default type is osgi.subsystem.composite. See *Subsystem-Content Requirements* on page 940.

Because this header influences resolution, it is only valid for it to be used on a Scoped Subsystem. If a Subsystems implementation encounters this header on an Unscoped Subsystem, it must fail the installation of the Subsystem.

The Preferred-Provider header has the effect of influencing the import policy into the Region representing the Scoped Subsystem that specified the header. If there are multiple candidate capabilities for a requirement and one or more of those capabilities is from a bundle or Subsystem identified in the Preferred-Provider header, then the Region import policy must prefer the capabilities from the preferred bundle or Subsystem.

A resource may be considered as a preferred provider only if it is a constituent of either the Scoped Subsystem's or any ancestor's Region.

## 134.5.4 Resource Repositories

When a Subsystem is installed the Subsystems implementation is responsible for provisioning resources that are associated with the Subsystem. For example, the Subsystem's content resources as well as any resources that are needed to satisfy dependencies of a Subsystem's content resources. During the Subsystem install process the Subsystems implementation uses a defined set of repositories to find the required resources needed to install a Subsystem. This set of repositories includes the following:

- *Local Repository* - Contains the resources included in the Subsystem Archive, see *Local Repository* on page 942.
- *System Repository* - Contains the resources currently installed, see *System Repository* on page 942
- *Repository Services* - The set of repositories registered as OSGi services, see *Repository Services* on page 942.
- *Content Repository* - The set of resources that comprise the Subsystem content, see *Content Repository* on page 942
- *Preferred Repository* - The set of resources that are considered preferred providers, see *Preferred Repository* on page 943.

### 134.5.4.1 Local Repository

The Root of the Subsystem Archive contains 0 or more resources. The Subsystems implementation must read all entries (except directory entries) in the Root of the Subsystem Archive and treat each entry as a potential resource. One way of describing the resource entries contained in the Root of the Subsystem Archive is in the terms of an Repository implementation. For the purpose of this specification these resources are referred to as the Subsystem's *Local Repository*. The Local Repositories must not be registered as an OSGi Repository service. Also, it is not required that the Subsystem implementation actually implement a Local Repository as a concrete implementation of the Repository service interface.

### 134.5.4.2 System Repository

The term *System Repository* is used to describe the set of resources that are constituents of one or more of the currently installed Subsystems. The System Repository must not be registered as an OSGi service. Also it is not required that System Repository be implemented as a concrete implementation of the Repository service. There is a single System Repository representing the resources installed in the OSGi framework.

### 134.5.4.3 Repository Services

The repositories which are registered as Repository services, see *Repository Service Specification* on page 889. These Repositories are used to discover Subsystem content resources and dependencies. A Subsystems implementation searches registered Repository services by service ranking order.

### 134.5.4.4 Content Repository

The set of content resources for a Subsystem is referred to as the Subsystem's Content Repository. Similar to the Local and System Repositories, the Content Repositories must not be registered as an OSGi service and it is not required that the Subsystems implementation actually implement a Content Repository as a concrete implementation of the Repository service. There are two types of resources that can exist in a Subsystem's Content Repository:

- *Installable Content* - A content resource which must be installed and result in a distinct resource at runtime. That is, a distinct bundle or Subsystem installation.

- *Shared Content* - A content resource which is already installed and is a constituent of one or more already installed Subsystems that belong to the same Region as the Subsystem that the Subsystem content repository is for. This resource must be reused, the Subsystems implementation must not install another instance of the resource.

Details on how the content resources are discovered for the Content Repository are discussed in *Discovering Content Resources* on page 943.

#### 134.5.4.5

#### Preferred Repository

The set of resources which are considered preferred providers of capabilities required by a Subsystem is referred to as the Preferred Provider Repository for the Subsystem. The Preferred Provider Repository for a Subsystem must not be registered as an OSGi service and it is not required that the Subsystems implementation actually implement the Preferred Provider Repository as a concrete implementation of the Repository service.

The following steps must be followed to discover the resources of the preferred provider repository for a Subsystem:

1. The Preferred-Provider header is parsed into a list of elements where each element specifies a single `osgi.identity` requirement, see *Preferred-Provider Header* on page 941.
2. For each `osgi.identity` requirement a Requirement object is created and used to search Repositories for preferred provider resources.
3. The System Repository is searched. For each capability found in the System Repository; if the resource providing the `osgi.identity` capability is a constituent contained in the parent Region of the Scoped Subsystem's Region then the providing Resource of the Capability is considered a preferred provider and the search stops; otherwise continue to the next step.
4. The Subsystem's Local Repository is searched. If a capability is found then the providing resource is used as a preferred provider and the search stops; otherwise continue to the next step.
5. The registered Repository services are searched. If a repository service finds a capability then the providing resource is used as a preferred provider and the search stops; otherwise the preferred provider is not found.

#### 134.5.5

#### Discovering Content Resources

When a Subsystem is installed the Subsystems implementation must determine the set of resources that compose the content of the Subsystem. The content resources of a Subsystem may be specified in the following ways:

- The values of the Subsystem-Content header must be used if it is present. See *Subsystem-Content Header* on page 939.
- The content of the Subsystem's Local Repository, if the Subsystem-Content header is not present.

When a Deployment Manifest is not present, *Pre-Calculated Deployment* on page 963, the Subsystems implementation must use this information to discover the content resources for a Subsystem as described in the following sections.

#### 134.5.5.1

#### Declared Subsystem-Content

If the Subsystem-Content manifest header is declared then the following steps must be followed to discover the Subsystem's contents:

- The Subsystem-Content header is parsed into a list of elements where each element specifies a single `osgi.identity` requirement. For each `osgi.identity` requirement element a Requirement is created and used to search Repositories for content resources.
  - If the Subsystem is a Scoped Subsystem then continue to the next step; otherwise if the Subsystem is an Unscoped Subsystem then the System Repository must be searched in order to

discover any currently installed resources that match the content Requirement. For each matching capability found it must be determined if the capability provider Resource is a constituent of a Subsystem which is in the same Region as the installing Subsystem; if so then the provider Resource must be used as an *shared content* resource. If no *shared content* resource is found then continue to the next step; otherwise the search stops.

- The Subsystem's Local Repository is searched to find a matching Capability for the content Requirement. If a Capability is found then the providing Resource of the Capability is used as an *installable content* resource of the Subsystem. If no *installable content* resource is found then continue to the next step, otherwise the search stops.
- The registered Repository services are searched to find a matching capability for the content Requirement. If a Repository finds a provider for the content requirement then the provider Resource of the capability is used as an *installable content* resource of the Subsystem. If no matching provider is found then the discovery of the content resource has failed.

#### 134.5.5.2

#### Use Subsystem Local Repository

If the Subsystem-Content header is not declared then the list of content resources is defined as all the Resources within the Subsystem's Local Repository which provide an `osgi.identity` capability with the type attribute of:

- `osgi.bundle`
- `osgi.fragment`
- `osgi.subsystem.application`
- `osgi.subsystem.composite`
- `osgi.subsystem.feature`
- Any other type that is supported by the implementation.

If a resource is found to be an unsupported type then installation of the Subsystem must fail.

For Scoped Subsystems this list is used as is and each Resource is considered an installable content resource. For Unscoped Subsystems the System Repository must be searched in order to determine if there are any already installed contents resources which may be used as a *shared content* resources. If no shared content resource can be found then the resource is considered an *installable content* resource.

## 134.6 Determining Dependencies

When a Subsystem is installed the Subsystems implementation determines the set of resources that compose the content of the Subsystem. Content resources may have requirements on capabilities that are not provided by any of the content resources for the Subsystem. When a Subsystem is installed the Subsystems implementation must determine the set of additional resources that are required in order to allow the Subsystem's content resources to resolve. These additional resources are called *dependencies*. When a Subsystem is installed the set of dependencies contains two types of resources:

- *Installable Dependency* - A resource which must be installed and result in a distinct resource at runtime. That is, a distinct bundle or Subsystem installation.
- *Preinstalled Dependency* - A resource which is already installed and is a constituent of one or more already installed Subsystems and the required capabilities provided by the resource are accessible according to the sharing policies of the Subsystems. This resource must be reused, the Subsystems implementation must not install another instance of the resource.

When a Deployment Manifest is not present, see *Pre-Calculated Deployment* on page 963, the Subsystems implementation must determine the set of dependencies for the Subsystem. To determine

the set of dependencies the Subsystems implementation should attempt to resolve the Subsystem content resources before installing the content resources. One possible way of resolving the content resources, before installing them, is to use a Resolver service, see *Resolver Service Specification* on page 1003. This specification illustrates the behavior of dependency resource discovery using terms defined by the Resolver service. A Subsystems implementation is not required to use the Resolver service to accomplish dependency resource discovery. Other mechanisms may be used to accomplish the same goal as long as the resolution results in a valid class space. Subsystems implementations need not guarantee to find a solution to every resolution problem, but if a valid solution is not found, then discovery of the dependencies must fail, resulting in an installation failure.

In order to use the Resolver service the Subsystems implementation has to provide a `ResolveContext` object that represents the currently installed Subsystems and their constituent resources. This resolve context must search Repositories in the following order when searching for capabilities to satisfy content dependencies within the `ResolveContext.findProviders` method. The Content Repository, Preferred Provider Repository, System Repository and Local Repository must all be searched and all the results presented to the Resolver with a corresponding preference. If a result was found in these repositories, searching the registered Repository services is optional, but if no result was found yet, the registered Repository services must be searched. The order of matching capabilities presented to the Resolver must coincide with the Repository search order.

1. The Content Repository.
2. The Preferred Provider Repository.
3. The System Repository. For each matching capability found in the System Repository the Subsystems implementation must determine if the capability is accessible to the content resources of the installing Subsystem according to the sharing policy of the Subsystem. See *Sharing Capabilities* on page 947 for more details on Subsystem types and their sharing policies.
4. The Local Repository. This allows a Subsystem Archive to optionally include dependencies.
5. The registered Repository services.

Any matching capabilities found in the steps after step 1 above are considered to be provided by potential dependencies for the Subsystem. The capabilities found in the System Repository are provided by already installed resources, referred to as potential *pre-installed dependencies*. The capabilities found which are provided by other potential dependencies must be installed in order to resolve the Subsystem content resources, referred to as *installable dependencies*.

The Resolver's job is to select one of the potential capabilities returned by the `findProviders` method as the capability to satisfy a Requirement. At the end of a resolve operation a result (`Map<Resource, List<Wire>`) is returned which contains the Resources that got resolved and a list containing the Wires for the resolved Resource. The Subsystems implementation uses this resolution result in order to determine which resolved Resources are content resources, pre-installed dependencies, or installable dependencies. The installable dependencies must be installed as described in *Accepting Dependencies* on page 945. The pre-installed dependencies must have their reference count incremented as described in *Reference Count* on page 952.

## 134.7 Accepting Dependencies

When a Subsystem is installed the Subsystems implementation must determine the set of installable dependencies as described in *Determining Dependencies* on page 944. The Subsystems implementation must also determine what Subsystem is willing to accept the installable dependency as a constituent, referred to as an *accepted dependency constituent*. A Subsystem declares that it is willing to accept dependencies as constituents by specifying the provision-policy directive with the `acceptDependencies` value on the `Subsystem-Type` header, see *Subsystem-Type Header* on page 932.

The `acceptDependencies` provision policy is useful for creating isolation layers that do not pollute parent Regions with dependencies. For example, an application container may be implemented as

a Subsystem. Such a container Subsystem could be installed into something called a kernel Subsystem. Applications are installed as Subsystems into the container Subsystem. In this case the container Subsystem would likely use the `acceptDependencies` provision policy so that any applications installed into the container Subsystem do not end up polluting the kernel Subsystem with the application's dependencies.

A dependency becomes an accepted dependency constituent of the Subsystem with a provision policy of `acceptDependencies` and that lies on the longest path between the Root Subsystem and the Subsystem being installed, inclusively. Note that a Subsystem that has `acceptDependencies` provision policy will accept its own installable dependencies as constituents since it lies on the longest path between the Root Subsystem and itself, inclusively.

The following figure illustrates a simple example of accepting dependency constituents. A Scoped Subsystem S2 is being installed into another Scoped Subsystem S1 and S1 has a provision-policy of `acceptDependencies`. When S2 is being installed the Subsystems implementation discovers content resources A and B and installable dependencies C and D. This is depicted in Figure 134.10.

Figure 134.10

Provision Policy

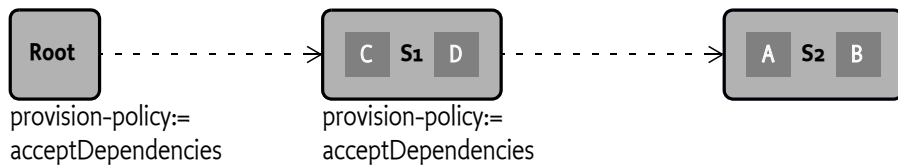

In the previous example the Subsystem with a provision-policy of `acceptDependencies` and that lies on the longest path between the Root Subsystem and the Subsystem being installed is S1. Therefore the installable dependencies C and D become accepted dependency constituents of S1.

Figure 134.11 illustrates the same example but with S2 also having a provision-policy of `acceptDependencies`

Figure 134.11

Provision Policy

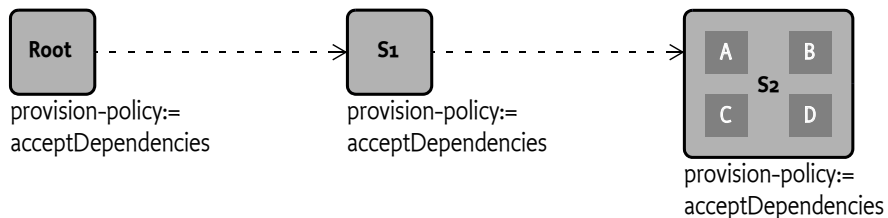

In this example the Subsystem with a provision-policy of `acceptDependencies` and that lies on the longest path between the Root Subsystem and the Subsystem being installed is S2 itself. Therefore the installable dependencies C and D become accepted dependency constituents of S2.

Figure 134.12 illustrates the same example but with S1 and S2 not defining the provision-policy (default is `rejectDependencies`). The Root Subsystem always has a provision-policy of `acceptDependencies`:

Figure 134.12

Subsystems and acceptDependencies

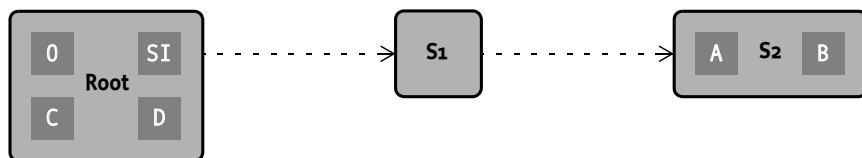

In this example the Subsystem with a provision policy of `acceptDependencies` and that lies on the longest path between the Root Subsystem and the Subsystem being installed is the Root Subsystem. Therefore the installable dependencies C and D become accepted dependency constituents of the Root Subsystem.

## 134.8 Sharing Capabilities

Scoped Subsystems define a sharing policy for the Region they are contained in. A sharing policy controls access to capabilities between parent → child Region boundaries. For Subsystems, a sharing policy is composed of two parts: an import policy and an export policy:

- *Export Policy* - Defines the set of capabilities provided by the constituents contained in the Region that are made available to the parent Region.
- *Import Policy* - Defines the set of capabilities which are available in the parent Region that are made available to the child Region.

The import sharing policies of a Subsystem's ancestor parent chain may prevent a Subsystem from accessing the required capabilities provided by a dependency. Figure 134.13 illustrates this.

Figure 134.13 Sharing Capabilities

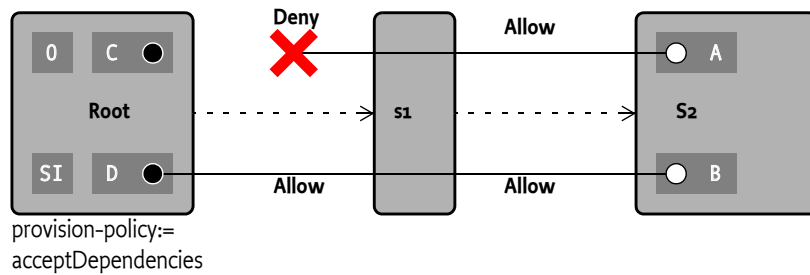

In this example the C and D provide capabilities that are required by A and B respectively. The import sharing policy of S2 allows the capabilities to be imported into S2, but the import sharing policy for S1 denies the import of one of the capabilities and allows the other. In order for A or B to access capabilities provided by C or D they must traverse both the import sharing policy of S2 and S1. Ultimately S1 sharing policy prevents the necessary access to the dependencies necessary to resolve S2. Such a situation must be detected during the discovery of the installable dependencies and result in a failure to install the dependencies. This must result in the failure to install the Subsystem that requires the dependency, in this case S2.

### 134.8.1 Preferred Provider

The sharing policy for a Scoped Subsystem may specify a set of preferred providers. If a capability is provided by a preferred provider then that capability must be used to resolve a Scoped Subsystem's import policy. Figure 134.14 illustrates this.

Figure 134.14 Preferred Provider

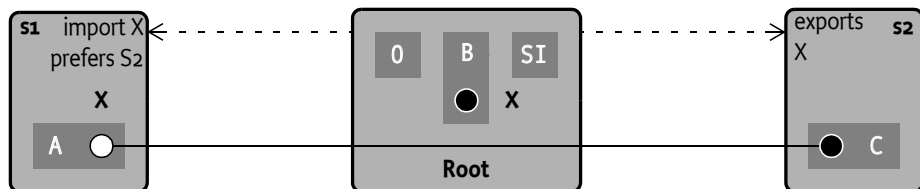

In this example constituent B of the Root Region provides the capability X (called Root→X). Also constituent C of S2Region provides the capability S2→X. The export sharing policy of S2 policy exports the capability S2→X to its parent Region, the RootRegion. The S1Region contains a constituent A that has a requirement on S1→X. The two capabilities, Root→X and S2→X, are available to satisfy the requirement S1→X. The S1Region's import sharing policy imports capability X and has a preferred provider of S2. This means that the capability S2→X must be used to satisfy the requirement S1→X.

### 134.8.2 System Capabilities

The `osgi.ee` and `osgi.native` namespaces are used by the System Bundle to describe capabilities for the Java execution environment and the native environment. These capabilities must only be provided by the System Bundle. A Subsystems implementation must allow access to the `osgi.ee` and `osgi.native` capabilities provided by the System Bundle to every Subsystem installed. This includes scoped subsystems which may or may not already have an import sharing policy configured to import these namespaces from the System Bundle.

## 134.9 Region Context Bundle

The Region context bundle provides a perspective from a constituent of a Subsystem contained in the Region. When a Scoped Subsystem is installed the Subsystems implementation must generate the Region context bundle and install it as a constituent bundle of the Subsystem. The Region context bundle has the following characteristics:

- Has a symbolic name of `org.osgi.service.subsystem.region.context.<subsystem id>`
- Version 1.0.0
- Has a location string of `<subsystem location>/<subsystem id>`
- Must always be allowed to resolve and start (i.e. has no requirements, imports or bundle activator).
- Has a start-level of 1 and is persistently started.
- Is installed and started before the Subsystem service is registered.

This bundle is installed and must remain active as long as the Subsystem is installed. If the Region context bundle is stopped, updated or uninstalled then the Subsystem runtime should log an error and may ensure the context bundle is installed and restarted.

When the Subsystems implementation is active it must establish the Root Subsystem, see *Subsystem Service* on page 955. In establishing the Root Subsystem the Subsystems implementation must ensure that there is a Region context bundle available for the Root Region. This Root Region context bundle will have a symbolic name of `org.osgi.service.subsystem.region.context.o`.

Typically the Region's context bundle would be used to obtain a bundle context with the `getBundleContext()` method, which has a perspective as a constituent of the Region. This is useful in the following ways:

- Implementing Subsystem aware extenders. Such extenders need to be able to register listeners and monitor the inside of a Region in order to react to the constituent bundles of a Region.
- Monitoring of internal events.

## 134.10 Explicit and Implicit Resources

Depending on how a resource is installed the Subsystems implementation considers the resource to be either an *explicit resource* or *implicit resource*. An *explicit resource* is a resource whose installation was initiated by an agent outside of the Subsystems implementation. An *implicit resource* is a re-



source whose installation was initiated by the Subsystems implementation during the explicit installation of a Subsystem, including the content and dependencies of the explicitly installed Subsystem.

### 134.10.1 Explicit Resources

An explicit resource is a resource that was installed programmatically, by an agent outside of the Subsystems implementation, using some resource specific API. This specification defines two types of resources that can be installed explicitly:

- *Subsystem resource* - A Subsystem resource may be installed explicitly by using the Subsystem service. Note that content and dependencies of an explicitly installed Subsystem are not considered to be explicit resources themselves since they were implicitly installed by the Subsystems implementation.
- *Bundle resource* - A bundle resource may be installed explicitly by using a bundle context. This includes fragments.

#### 134.10.1.1 Explicit Bundle Resources

When a bundle is installed explicitly with a bundle context, the Subsystems implementation must determine the Subsystem of which a bundle becomes a constituent. The following rules are followed when a bundle is installed explicitly with a bundle context:

1. Determine the bundle performing the install. This is the bundle whose Bundle Context is performing the install operation.
2. Determine the target Region. This is the Region to which the bundle performing the install operation belongs.
3. If a bundle with the same symbolic name and version already exists in the target Region then the bundle installation must fail unless the same location string is used. If the same location is used then the existing bundle is returned. This may be accomplished by the use of a bundle collision hook.
4. Determine the Subsystem(s) of which the bundle performing the install is a constituent. The bundle performing the install may be a shared resource. In that case the bundle performing the install is a constituent of two or more Subsystems.
5. The newly installed bundle must become a constituent of all the Subsystems of which the bundle performing the install is a constituent.

#### 134.10.1.2 Explicit Subsystem Resources

When a Subsystem is installed explicitly with a Subsystem service, the Subsystems implementation must determine what Subsystem(s) the Subsystem resource and its children will become a constituent of. The following rules are followed when a Subsystem is installed:

1. Determine the target Subsystem. This is the Subsystem service which is performing the install operation or the Subsystem which includes another Subsystem as part of its content, see *Determining Content* on page 939.
2. Determine the target Region. This is the Region to which the target Subsystem belongs.
3. If no Subsystem resource with the same location exists then continue to the next step; otherwise do the following:
  - If the existing Subsystem is not a part of the target Region then fail the install operation by throwing a Subsystem Exception; otherwise continue to the next step.
  - If the existing Subsystem symbolic name, version and type is not the same as the Subsystem being installed then fail the install operation by throwing a Subsystem Exception; otherwise continue to the next step.
  - If the existing Subsystem is already a constituent of the target Subsystem then return the existing Subsystem from the install method; otherwise the existing Subsystem resource be-

comes a shared resource by increasing the reference count of the existing Subsystem by one, see *Reference Count* on page 952, and the existing Subsystem becomes a constituent of the target Subsystem; finally, the existing Subsystem is returned from the install method.

4. If no Subsystem resource with the same symbolic-name and version already exists in the target Region then the Subsystem resource being installed becomes a constituent of the Subsystem target; otherwise do the following:
  - If the existing Subsystem type is not the same as the type of the Subsystem being installed then fail the install operation by throwing a Subsystem Exception; otherwise continue to the next sub-step.
  - If the existing Subsystem is already a constituent of the target Subsystem then return the existing Subsystem from the install method; otherwise the existing Subsystem resource becomes a shared resource by increasing the reference count of the existing Subsystem by one and the existing Subsystem becomes a constituent of the target Subsystem; finally, the existing Subsystem is returned from the install method.

### 134.10.2 Explicit Resource Example

A scenario is used to illustrate the rules for determining which Subsystem an explicitly installed resource is a constituent. Figure 134.15 illustrates the Root Subsystem with initial content bundles A, S1 (Subsystems implementation) and the system bundle (id = 0) installed.

Figure 134.15 *Explicit Resource Example*

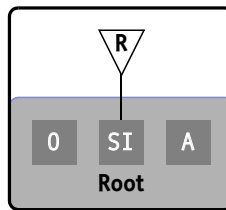

If bundle A uses its own Bundle Context to explicitly install bundle B then bundle B becomes a constituent of the Root Subsystem. If bundle A uses Subsystem R to install Scoped Subsystem S1 then the S1 resource becomes a constituent of the Root Subsystem and S1 Subsystem becomes a child of the Root Subsystem. S1 contains constituent bundles C and D. Also, if bundle B uses Subsystem R to install Scoped Subsystem S2 then the S2 resource becomes a constituent of the Root Subsystem and the S2 Subsystem becomes a child of the Root Subsystem. S2 contains constituent bundles E and F. Figure 134.16 illustrates this.

Figure 134.16 *Subsystems and Resources*

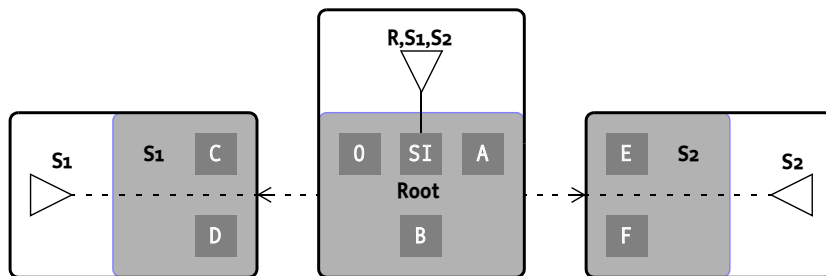

Then if bundle C uses its own Bundle Context to install bundle F (using a different location string from constituent bundle S2→F) then the bundle becomes a constituent of S1. If bundle E uses Sub-

system service S2 to install Unscoped Subsystem U1 (with constituents G and H) and installs Unscoped Subsystem U2 (with constituents H and J) then both Subsystem bundles U1 and U2 become constituents of S2. The S2 Subsystem also becomes the parent Subsystem for both U1 and U2 Subsystems, see Figure 134.17.

Figure 134.17 Subsystems and Resources

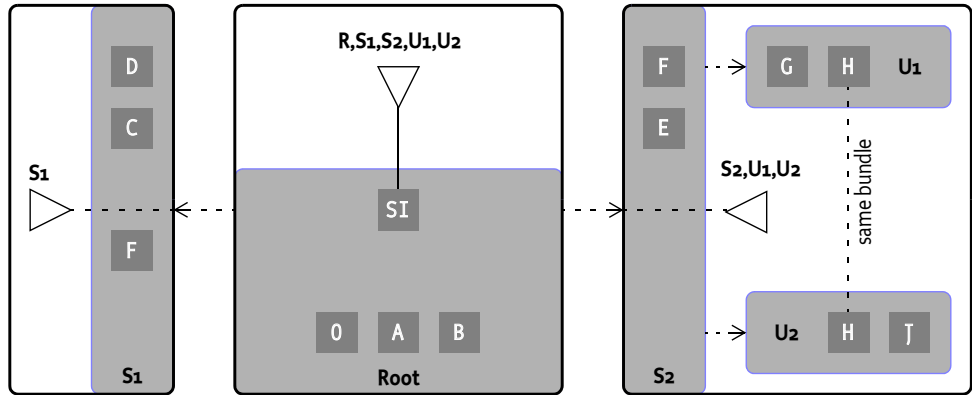

In this scenario bundle H is a shared constituent of both U1 and U2 Subsystems. If bundle H installs a bundle K with its bundle context then bundle K becomes a shared constituent of both U1 and U2 Subsystems. Also, if Subsystem service U1 is used to install Scoped Subsystem S3 and Subsystem service U2 is also used to install Subsystem S3 then S3 resource becomes a shared constituent of both Unscoped Subsystems U1 and U2. The following illustrates this:

Figure 134.18 Subsystems and Resources

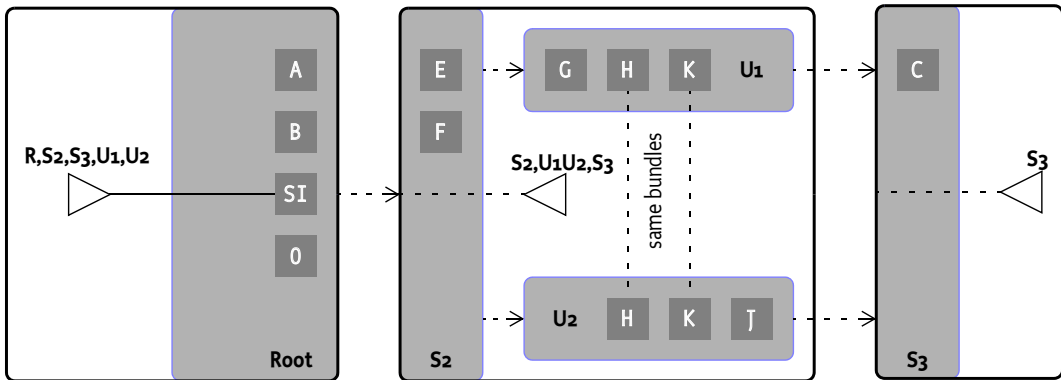

Since the S3 Subsystem resource is a shared constituent of both Subsystems U1 and U2 the S3 Subsystem has two parents: U1 and U2. In this case S3 Subsystem has two parent Subsystems but the S3Region still must only have one parent of S2Region. This is enforced by the rule that requires all of the parents of a Subsystem to belong to the same Region. For Scoped Subsystems the Region which contains all of the Subsystem's parents is parent Region.

So far the examples have illustrated cases where the Root Subsystem has Scoped Subsystem children. It is also acceptable for an Unscoped Subsystem to be installed into the Root Region as the following figure illustrates:

Figure 134.19 Subsystems and Resources

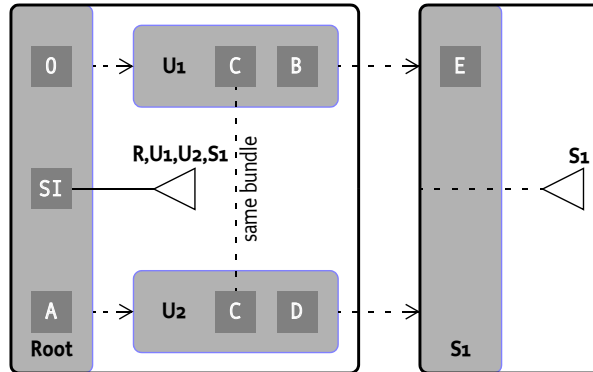

## 134.11 Resource References

A Subsystems implementation must track the resources which are installed and determine which Subsystems reference a resource. The *reference count* indicates the number of installed Subsystems which reference an installed resource. The resource references and reference counts are used by the Subsystems implementation to determine if an installed resource is eligible for garbage collection and also plays a role in determining when a resource should be started and stopped, see *Starting and Stopping Resources* on page 953 ; the term reference count is only used to illustrate these concepts. The reference count of a resource is not exposed in the API of Subsystems. The following types of resources are referenced by a Subsystem:

- *Content Resources* - These are the content resources which were installed when the Subsystem was installed, that is the resources declared in the Subsystem-Content header or from the Local Repository when the Subsystem-Content header is not specified, see *Determining Content* on page 939. Content Resources are considered to be implicit resources.
- *Explicit Resources* - These are constituent resources which are installed explicitly, see *Explicit Resources* on page 949.
- *Dependencies* - These resources provide capabilities required to satisfy requirements for a Subsystem's content resources, see *Determining Dependencies* on page 944. Dependencies are considered to be implicit resources.

Accepted dependency constituents are not defined as being referenced by the Subsystem of which they are a constituent unless constituent resource is a dependency for that Subsystem. Parent Subsystems are also not defined as being referenced by a child Subsystem.

### 134.11.1 Reference Count

When a Subsystem is being installed the Subsystems implementation must determine what resources are referenced by the Subsystem being installed. Each resource that is referenced by the Subsystem being installed will have its reference count incremented by 1. A top-level Subsystem being installed may contain child Subsystems. Each resource that is referenced by the child Subsystem being installed will have its reference count incremented by 1.

When a Subsystem is being uninstalled the Subsystems implementation must determine what resources are referenced by the Subsystem being uninstalled. Each resource that is referenced by the Subsystem being uninstalled will have its reference count decremented by 1. A top-level Subsystem being uninstalled may contain child Subsystems. Each resource that is referenced by each child Subsystem being uninstalled will have its reference count decremented by 1.

When a reference count gets set to zero then the resource is eligible for garbage collection and will be uninstalled. A Subsystems implementation may perform the garbage collection immediately or postpone the garbage collection for later. If garbage collection is postponed then the Subsystems implementation must prevent any additional usage of capabilities provided by the resource which is to be uninstalled. The garbage collection must occur in a reasonable period of time.

Bundle resources (including fragments) and Subsystem resources may be uninstalled explicitly. For example, uninstalling a Subsystem resource through the Subsystem service, or by other means outside of the Subsystems API such as uninstalling a bundle using a Bundle object. Each of the following must occur when a resource is explicitly uninstalled:

- If the resource being explicitly uninstalled was not itself installed explicitly then an error must be logged indicating that the explicitly uninstalled resource still has one or more Subsystems referencing it.
- If the resource being explicitly uninstalled was itself installed explicitly and the reference count is greater than 1 then an error must be logged indicating that the explicitly uninstalled resource still has one or more Subsystems referencing it.
- The resource being explicitly uninstalled has its reference count set to 0 and finally the resource is uninstalled.

## 134.12 Starting and Stopping Resources

A Subsystem can be started by calling the Subsystem *start* method or the Subsystems implementation can automatically start the Subsystem if the Subsystem is *ready* and the *autostart setting* of the Subsystem indicates that it must be started.

A Subsystem is *ready* if the Subsystem's parent is in the process of starting or is active. A started Subsystem may need to be automatically started again by the Subsystems implementation after a restart. The Subsystems implementation therefore maintains a persistent *autostart setting* for each Subsystem. This *autostart setting* can have the following values:

- *Stopped* - The Subsystem should not be started.
- *Started* - The Subsystem must be started once it is ready.

Subsystem resources which are installed as content resources, see *Discovering Content Resources* on page 943, of one or more Subsystems must have their *autostart setting* set to *started*.

When a Subsystem is started and stopped then the resources the Subsystem references may be started and stopped. See for details *Starting* on page 961 and *Stopping* on page 961.

The Subsystems implementation must track the resources which are installed and be able to determine when a resource must be started and stopped. To describe this behavior the term *active use count* is used. A active use count indicates the number of active Subsystems which reference a resource. The active use count is used by the Subsystems implementation in order to determine when a resource is started and stopped. The term active use count is only used to illustrate the starting and stopping of resources. The active use count of a resource is not exposed in the API of Subsystems.

Resource starting and stopping only applies to resources for which it is valid to start and stop. For example, it is not valid to start or stop resources of type *osgi.fragment* and a Subsystems implementation must not attempt to start or stop such resources.

### 134.12.1 Start Order

A Subsystem's Subsystem-Content header, see *Subsystem-Content Header* on page 939, can use the optional *start-order* directive for each content resource it declares. The *start-order* directive specifies the start order of the content resource in relation to other content resources of the Subsystem. Content resources are started in ascending order and stopped in descending order according to the

start-order directive values. Content resources with the same start-order value may be started and stopped in any order in relation to each other. There is no default value for start-order. If the start-order is not specified then a Subsystem implementation is free to start the resource in any order. For example, the following header specifies four Subsystem content resources:

```
Subsystem-SymbolicName: S1
Subsystem-Type: osgi.subsystem.composite
Subsystem-Content:
  A;
    type=osgi.bundle;
    version=1.0;
    start-order:=3,
  B;
    type=osgi.bundle;
    version=1.0;
    start-order:=2,
  C;
    type=osgi.bundle;
    version=1.0;
    start-order:=1,
  D;
    type=osgi.bundle;
    version=1.0;
    start-order:=2
```

The above headers specify a Subsystem S1 with four content resources: A, B, C and D. The start-order directive is used to sort the content resources to determine the order to start or stop them when the Subsystem is started or stopped. The content resources are sorted from lowest to highest start-order. Content resources that have the same start-order value may be started and stopped in any order in relation to each other. In this example the content resources are sorted into the list [C], [B, D], [A]. C has the lowest start-order, therefore it is the first in the list. B and D have the same start-order and therefore can be started in any order in relation to each other. Finally A is last in the list because it has the highest start-order.

When the Subsystem S1 is started the content resource C must be started first, followed by the starting of B and D in any order, finally resource A is started last. When the Subsystem S1 is stopped the content resource A must be stopped first, followed by the stopping of B and D in any order, finally resource C is stopped last.

Resources that do not specify a start-order can be started and stopped in any order.

## 134.12.2

### Active Use Count

When a Subsystem is being started the Subsystems implementation must increment the active use count of every resource which is referenced by the Subsystem being started, see *Resource References* on page 952. After incrementing the active use counts of the resources referenced by a Subsystem, the Subsystems implementation must determine which referenced resources need to be started. For each resource referenced by the Subsystem which is valid to be started; if the active use count is greater than zero and the resource is not currently active then the resource must be started. The collection of dependencies are started before the Subsystem's content resources. The start order for the individual resources contained in the collection of dependencies is not specified. See *Start Order* on page 953.

When a Subsystem is being stopped the Subsystems implementation must decrement the active use count of every resource which is referenced by the Subsystem being stopped. After decrementing the active use counts of the resources referenced by a Subsystem, the Subsystems implementation must determine which referenced resources need to be stopped. For each resource referenced by the Subsystem which is valid to be started; if the active use count equals zero and the resource is

currently active then the resource must be stopped. The Subsystem content resources are stopped before the collection of dependencies. *Start Order* on page 953 describes the stop order of the Subsystem's content resources. The stop order of the individual resources contained in the collection of dependencies is not specified.

When starting the resource types supported by this specification the following rules apply:

- `osgi.bundle` - The bundle must be transiently started using the activation policy of the bundle, that is with the `Bundle.START_ACTIVATION_POLICY`.
- `osgi.fragment` - fragments cannot be started, this is a no-op.
- `osgi.subsystem.application`, `osgi.subsystem.composite`, `osgi.subsystem.feature` - The Subsystem must be transiently started if its *autostart setting* is set to *started*.

When stopping the resource types supported by this specification the following rules apply:

- `osgi.bundle` - The bundle must be persistently stopped.
- `osgi.fragment` - Fragments cannot be stopped, this is a no-op.
- `osgi.subsystem.application`, `osgi.subsystem.composite`, `osgi.subsystem.feature` - The Subsystem must be transiently stopped. Its *autostart setting* must not be changed.

Note that for resources referenced by a stopped Subsystem; bundle resources are persistently stopped and Subsystem resources are transiently stopped. This is a safeguard to handle cases where a constituent bundle is eagerly started by some other agent outside of the Subsystems implementation. Persistently started bundles will get auto started by the framework according to the start-level of the bundle. This can cause a constituent bundle to be stopped even though the Subsystem it is a constituent of is not active. To avoid this situation the Subsystems implementation always clears the persistent autostart setting of the bundle resources.

Subsystem resources which are referenced by a Subsystem are started or stopped transiently. There is no API to transiently start or stop a Subsystem. The Subsystems implementation must perform the starting or stopping of a referenced Subsystem normally except the starting or stopping process does not change the *autostart setting* for the referenced Subsystem.

## 134.13 Subsystem Service

The Subsystem service represents an Subsystem Archive resource that is installed in an OSGi Framework. The installation of a Subsystem can only be performed by using the Subsystem service API or through implementation specific means. The Subsystem interface's methods and service properties can be divided into the following categories:

- *Information* - Access to information about the Subsystem itself as well as other Subsystems that are installed.
- *Life Cycle* - The possibility to install other Subsystems and start, stop, and uninstall Subsystems.

For each Subsystem installed, the Subsystems implementation must register an associated Subsystem object as a service. The Subsystem service is used for monitoring the state of the Subsystem, for controlling the life cycle of the installed Subsystem and for installing child Subsystems.

### 134.13.1 Root Subsystem

A Subsystems implementation must register the Root Subsystem service. When a Subsystems implementation is started for the first time it must establish the Root Subsystem. The following steps are required to establish the Root Subsystem.

1. The Root Subsystem has a symbolic name `org.osgi.service.subsystem.root`, version `1.0.0` (the version of the Subsystems specification), a Subsystem id of `0` and a location of

```
subsystem: //?Subsystem-SymbolicName=org.osgi.service.subsystem.root& «
  Subsystem-Version=1.0.0
```

2. The Root Subsystem has no parent Subsystem. More specifically the Root Subsystem is the only source vertex in the Subsystem graph.
3. The Root Subsystem is considered a Scoped Subsystem of type application, with provision-policy of acceptDependencies. Since the Root Subsystem has no parent it does not import or export any capabilities.
4. The Subsystem content is the set of bundles installed in the framework that do not belong to any other Subsystem.
5. The root subsystem has a region context bundle as described in *Region Context Bundle* on page 948.

The Root Subsystem always exists when a Subsystems implementation is present and active, even if no other Subsystems are installed The Root Subsystem is used as the starting point for installing Subsystems as child Subsystems. The Root Subsystem cannot be stopped or uninstalled by calling the Subsystem service stop or uninstall methods. Any attempt to do so must result in a Subsystem Exception.

### 134.13.2 Subsystem Service Properties

The primary means of discovering and monitoring a Subsystem is the Subsystem service. A Subsystems implementation must register one Subsystem service for each Subsystem installed. The Subsystem service is used for monitoring and controlling the life-cycle of the installed Subsystem. Service properties on the Subsystem service carry most of the information required to monitor Subsystem life cycle operations and the current state of a Subsystem. The following table describes the service properties of a Subsystem:

Table 134.1 *Subsystem Mandatory Service Properties*

Key Name	Type	Description
subsystem.id	Long	The Subsystem id of the Subsystem
subsystem.symbolicName	String	The symbolic name of the Subsystem
subsystem.version	Version	The version of the Subsystem
subsystem.type	String	The type of Subsystem.
subsystem.state	<a href="#">Subsystem.State</a>	Contains the current state of the Subsystem

### 134.13.3 Subsystem States

The Subsystem service property `subsystem.state` contains the current state of the Subsystem (this is referred to as the *subsystem state*). All Subsystem states are defined by the `Subsystem.State` enum, for example, `INSTALLED`. The possible values of a `subsystem.state` are shown in the table below:

Table 134.2 *Subsystem States*

<code>subsystem.state</code>	Description
<a href="#">INSTALLING</a>	When a Subsystem is first installed the Subsystems implementation must register a Subsystem service with the initial <code>subsystem.state</code> of <a href="#">INSTALLING</a> . The <code>subsystem.state</code> must remain in the <a href="#">INSTALLING</a> state until all of the Subsystem constituents are installed successfully.
<a href="#">INSTALLED</a>	When all contents of a Subsystem has been successfully provisioned then the <code>subsystem.state</code> is set to <a href="#">INSTALLED</a> .
<a href="#">INSTALL_FAILED</a>	Indicates that some failure occurred while attempting to install the Subsystem's contents.



subsystem.state	Description
RESOLVING	Starting a Subsystem triggers the resolution of a Subsystem if the subsystem.state is <b>INSTALLED</b> . A <b>RESOLVING</b> state indicates that a resolve process is occurring in an attempt to resolve all of the subsystem's content resources.
RESOLVED	Indicates that the Subsystem is resolved. A Subsystem is resolved if all of its content resources are resolved.
STARTING	Indicates that the Subsystem is in the process of being started. During this state the resources the Subsystem references which are eligible for starting are started, see <i>Starting and Stopping Resources</i> on page 953. Once all the eligible resources are successfully started then the subsystem.state is set to <b>ACTIVE</b> .
ACTIVE	The <b>ACTIVE</b> state indicates that all eligible resources referenced by the Subsystem were successfully started during the starting process.
STOPPING	Indicates that the Subsystem is in the process of being stopped. During this state the resources referenced by the Subsystem are stopped if appropriate.
UNINSTALLING	Indicates that the Subsystem is in the process of being uninstalled. During this state the resources referenced by the Subsystem are marked for garbage collection if they are eligible, see <i>Resource References</i> on page 952.
UNINSTALLED	When all of the resources referenced by the Subsystem which are eligible for garbage collection have been uninstalled then the subsystem.state is set to <b>UNINSTALLED</b> .

### 134.13.4 Subsystem Service Registrations

The Subsystems implementation must register one Subsystem service for each Subsystem installed. The Subsystems implementation must provide access to every Subsystem service from the Root Region. Every other Region must have access to the following Subsystem Services:

- Subsystem service representing the Scoped Subsystem of the Region.
- All Unscoped Subsystem services contained in the Region.
- All Subsystems which are children of a Subsystem contained in the Region.

A Region is granted access to the Subsystem services listed above automatically by the Subsystems implementation regardless of the sharing policy defined by the Scoped Subsystem of that Region. Additional Subsystem services may be imported into a Region from its parent Region by the sharing policy defined by the Scoped Subsystem of that Region.

For example, a Root Subsystem and Root Region that has two Scoped Subsystem children, S1 and S2. All Subsystem services are registered by the Subsystems implementation and are visible in the Root Region. The S1 Subsystem service is also implicitly visible in the S1 Region because it represents the Scoped Subsystem S1 contained in that Region. Similarly the S2 Subsystem service is also implicitly visible from the S2 Region. This example is depicted in Figure 134.20.

Figure 134.20 Root, attached to Scoped Subsystems S1, S2

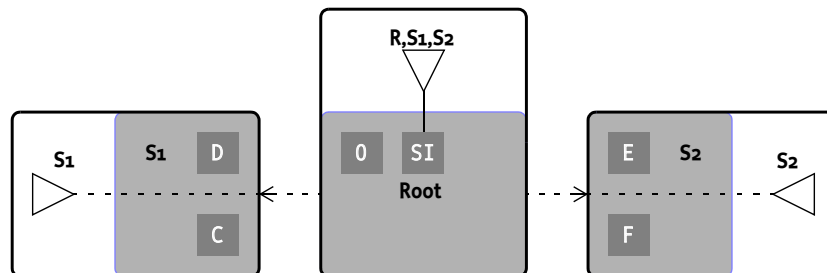
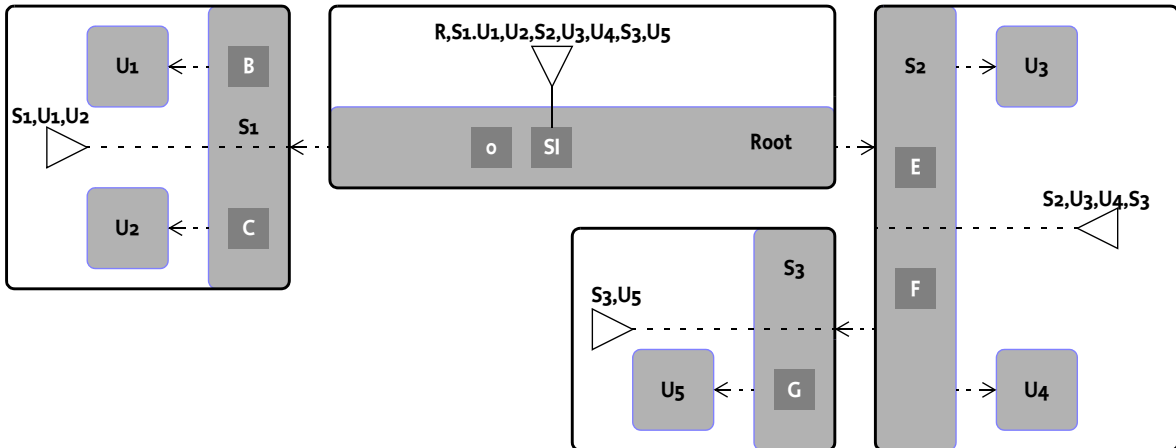

Figure 134.21 defines a more complicated scenario where Subsystems and multiple children are involved.

Figure 134.21 Complex example Subsystem scoping



All Subsystem services are visible in the Root Region. The S1 Subsystem service is also implicitly visible in the S1 Region because it represents the Scoped Subsystem S1 contained in that Region. The S1 Region also has visibility to the U1 and U2 Subsystem services because these Unscoped Subsystems are contained in the S1 Region. Similarly the S2 Subsystem service is also implicitly visible from the S2 Region. The S2 Region also has visibility to the U3 and U4 Subsystem services because these Unscoped Subsystems are contained in the S2 Region. The S2 Region also has visibility to the S3 Subsystem service because the S3 Subsystem is a child of a Subsystem contained in the S2 Region. Finally, the S3 Region has implicit visibility to the S3 Subsystem service and it has visibility to the U5 Subsystem service because the Unscoped Subsystem is contained in the S3 Region.

Note that a Scoped Subsystem's import sharing policy may grant its Region visibility to additional Subsystem services.

### 134.13.5 Subsystem Manifest Headers

The Subsystem service interface has the [getSubsystemHeaders\(Locale\)](#) method which returns the values of the Subsystem's manifest headers. The headers returned by this method includes the values specified in the Subsystem manifest file and the values derived by the Subsystems implementation. Certain manifest headers may be derived at install time by the Subsystems implementation if they were not specified in the Subsystem manifest file. When a Subsystem manifest value is derived then the derived value must be included in the headers returned by the method [getSubsystemHeaders\(Locale\)](#). The following Subsystem manifest headers may be derived by the Subsystems implementation:

- Subsystem-SymbolicName
- Subsystem-Version
- Subsystem-Content

## 134.14 Subsystem Life Cycle

The Subsystems specification provides an API to control the life cycle operations of a Subsystem. For each Subsystem installed there is an associated Subsystem object (also registered as a Subsystem service). A Subsystem's life-cycle is controlled by operations performed on the Subsystem object. Operations performed on the Subsystem may also cause equivalent operations on the resources referenced by the Subsystem. For example starting a Subsystem will cause all of its content resources to start if appropriate.



- *Persistent* - The Subsystem must remain installed across framework and Java VM invocations until the Subsystem is explicitly uninstalled.
- *Atomic* - The install method must completely install the Subsystem or, if installation fails, the Subsystems implementation must leave the framework in the same state as it was before the method was called.

Once a Subsystem has been installed, a Subsystem object is created and all remaining life cycle operations for the installed Subsystem must be performed upon this object. The returned Subsystem object can be used to start, stop, and uninstall the Subsystem as well as install child Subsystems.

When a Subsystem is being installed the Subsystems implementation must perform the following operations synchronously before returning from the install method:

1. Determine the symbolic name, version, and type for the Subsystem being installed as defined in *Subsystems* on page 928. If the Subsystem name, version or type are invalid then the install fails and a Subsystem Exception is thrown.
2. Determine the Subsystems for which the Subsystem being installed will become a constituent of by following the steps in *Explicit and Implicit Resources* on page 948.
3. Determine the Subsystem identifier. Subsystem identifiers are unique and assigned by the Subsystems implementation.
4. If the Subsystem is a Scoped Subsystem then create the new Region for the Subsystem and install and start the Region context bundle. See *Region Context Bundle* on page 948 for the Region context bundle.
5. Register a Subsystem service with the initial `system.state` service property set to `INSTALLING`. This Subsystem service represents the Subsystem resource. See *Subsystem Service Properties* on page 956 and *Subsystem Service Registrations* on page 957 for more details.
6. Determine the Subsystem content resources. See *Determining Content* on page 939 for details on how the Subsystem contents are determined. If the contents cannot be discovered successfully and the content is not optional then an installation failure occurs and a Subsystem Exception is thrown. Otherwise continue to the next step.
7. Determine the Subsystem dependencies. See *Determining Dependencies* on page 944 for details on determining the Subsystem's dependencies. If the dependencies cannot be determined successfully then an installation failure occurs and a Subsystem Exception is thrown. Otherwise continue to the next step.
8. Install the dependencies. The Subsystems implementation must prevent resolution of dependency wires to the capabilities provided by the installed dependencies until the Subsystem has successfully entered `INSTALLED` state. See *Explicit and Implicit Resources* on page 948 for details on where dependencies are installed and see *Resource References* on page 952 for how they are tracked. If any dependency fails to install then an installation failure occurs and a Subsystem Exception is thrown. Otherwise continue to the next step.
9. Install content resources. The content resources must be disabled from resolving until the Subsystem has successfully entered `INSTALLED` state. If any content resource fails to install then an installation failure occurs and a Subsystem Exception is thrown. Otherwise continue to the next step.
10. If the Subsystem is scoped, enable the import sharing policy for the Region. See *Sharing Capabilities* on page 947.
11. Enable resolution for all of the Subsystem content and any dependencies installed. Set the `system.state` to `INSTALLED` and return the installed Subsystem object.

The state `INSTALL_FAILED` is used to inform about an installation failure. All installation failures use the following steps:

1. When a Subsystem fails to install it enters the `INSTALL_FAILED` state.
2. Immediately transition the Subsystem to the `UNINSTALLING` state.

3. All content and dependencies which may have been installed by the Subsystem installing process must be uninstalled.
4. Transition the Subsystem to the `UNINSTALLED` state.
5. Unregister the Subsystem service.
6. If the Subsystem is scoped then, uninstall the Region context bundle.
7. Throw a Subsystem Exception indicating an install failure.

### 134.14.2 Resolving

A Subsystem's resolve process is initiated by performing a start operation on a Subsystem whose `system.state` is currently set to `INSTALLED`. There is no explicit operation for initiating the resolve process of a Subsystem. The Subsystems implementation is free to initiate the resolve process for a Subsystem for any reason. For example, the Subsystems implementation may choose to try to resolve all currently installed Subsystems when the start operation is performed on a single Subsystem.

### 134.14.3 Starting

A Subsystem can be started by calling the Subsystem `start()` method or the Subsystems implementation can automatically start the Subsystem if the Subsystem is *ready* and the *autostart setting* of the Subsystem indicates that it must be started. When a Subsystem is being started the Subsystems implementation must perform the following operations synchronously before returning from the `start()` method:

1. If the `system.state` is `INSTALL_FAILED`, `UNINSTALLED`, or `UNINSTALLING`, then an Illegal State Exception is thrown.
2. Set the Subsystems *autostart setting* to *started*.
3. If the `system.state` is `ACTIVE` then the start method returns immediately.
4. If the Subsystem is not *ready* to be started then the start method returns immediately.
5. If this `system.state` is `RESOLVING`, `STARTING` or `STOPPING`, then the start method must wait for starting or stopping to complete before continuing. If this does not occur in a reasonable time, a Subsystem Exception is thrown to indicate the Subsystem was unable to be started.
6. If the `system.state` is `RESOLVED` then continue to the next step; otherwise if the `system.state` is `INSTALLED` then the `system.state` is set to `RESOLVING` and an attempt is made to resolve all of the Subsystem's content resources. If all contents are resolved then set the `system.state` to `RESOLVED`, enable the export sharing policy and continue to the next step; otherwise a starting failure occurs and a Subsystem Exception is thrown.
7. Set the `system.state` to `STARTING`.
8. Start all resources referenced by the Subsystem according to *Starting and Stopping Resources* on page 953. If all of the resources start successfully then continue to the next step; otherwise a start failure occurs.
9. Set the `system.state` to `ACTIVE` and return.

All start failures use the following steps:

1. If the `system.state` is `STARTING` then change the state to `STOPPING`.
2. Stop all resources that were started as part of this operation.
3. Change the state to `INSTALLED` or `RESOLVED` depending on if the Subsystem was resolved.
4. Throw a Subsystem Exception indicating the cause of the start failure.

### 134.14.4 Stopping

A Subsystem's stop process is initiated using the Subsystem service's `stop()` method. When a Subsystem is being stopped the Subsystems implementation must perform the following operations synchronously before returning from the `stop()` method:

1. If the `subsystem.state` is `UNINSTALLED`, `INSTALL_FAILED`, or `UNINSTALLING`, then an `Illegal State Exception` is thrown.
2. Set the Subsystems *autostart setting* to *stopped*.
3. If the `subsystem.state` is `RESOLVED` or `INSTALLED` then the `stop()` method returns immediately.
4. If this `subsystem.state` is `STARTING` or `STOPPING`, then the `stop` method must wait for starting or stopping to complete before continuing. If this does not occur in a reasonable time, a `Subsystem Exception` is thrown to indicate the Subsystem was unable to be stopped.
5. Set the `subsystem.state` to `STOPPING`.
6. Stop all resources referenced by the Subsystem according to *Starting and Stopping Resources* on page 953. If any error occurs while stopping a resource the Subsystems implementation must continue to stop the remaining resources that are eligible to stop.
7. Set the `subsystem.state` to `RESOLVED`.

With regard to error handling while stopping resources referenced by the Subsystem, errors subsequent to the first should be logged. Once the stop process has completed, a `Subsystem Exception` must be thrown with the initial error as the specified cause.

### 134.14.5 Uninstalling

A Subsystem's uninstall process is initiated using the Subsystem service's `uninstall()` method. To whatever extent possible, the Subsystems implementation must determine the resources referenced by the Subsystem which are eligible for garbage collection, *Reference Count* on page 952. This method must always uninstall the Subsystem from the persistent storage of the Subsystems implementation.

Once this method returns, the state of the platform must be the same as if the Subsystem had never been installed, unless some bundle resource which was uninstalled has exported package which are being used by other bundles still installed in the platform. All old exports must remain available for existing bundles and future resolves until the uninstalled bundle is refreshed or the framework is restarted.

When a Subsystem is being uninstalled the Subsystems implementation must perform the following operations before returning from the `uninstall()` method:

1. If the `subsystem.state` is `UNINSTALLED` then this method returns immediately.
2. If the `subsystem.state` is `STARTING`, `STOPPING` or `ACTIVE` then the Subsystem is stopped according to *Stopping* on page 961. Otherwise continue to the next step.
3. If the `subsystem.state` is `INSTALLING` and the installing process is interruptible, fail the install process; otherwise, wait until the installation is complete.
4. If the `subsystem.state` is in the `INSTALL_FAILED` state then skip to step 6.
5. Set the `subsystem.state` to `INSTALLED`.
6. Set the `subsystem.state` to `UNINSTALLING`.
7. Determine the resources referenced by the Subsystem which are eligible for garbage collection according to *Reference Count* on page 952. If a Subsystems implementation does garbage collection synchronously and any error occurs while uninstalling a resource the Subsystems implementation must continue to uninstall the remaining resources that are eligible to garbage collect.
8. Set the `subsystem.state` to `UNINSTALLED`.
9. Unregister the Subsystem service.
10. If the Subsystem is a Scoped Subsystem then uninstall the Region context bundle. At this point the Region no longer exists.

With regard to error handling while synchronously uninstalling resources eligible for garbage collection, errors subsequent to the first should be logged. Once the uninstall process has completed, a `Subsystem Exception` must be thrown with the initial error as the specified cause.

## 134.15 Pre-Calculated Deployment

A pre-calculated deployment in the form of a deployment manifest can be included as part of a Subsystem Archive or provided by a deployer at installation time. Manifests provided at install time override those included within an archive, and those within an archive override calculated ones. The deployment manifest defines the precise deployment of the Subsystem. Providing a deployment manifest means a Subsystem can be deployed and the exact resources that are installed are known ahead of time. This allows test teams to test specific deployments and these same deployments can then be used in production. The deployment manifest is a locking down of the variability in a Subsystem manifest (or the equivalent if the Subsystem definition is calculated during deployment based on the Subsystem Archive). The deployment manifest follows the same syntax rules as the Subsystem manifest but uses different headers for deployment-specific information. A deployment manifest describes the following:

- The exact versions for content resources
- Any dependencies required to resolve the Subsystem's content that are not satisfied by the target runtime
- Sharing policy for requirements and capabilities shared into or out of the Subsystem.

Because a Deployment Manifest's dependencies bridge between the requirements of the Subsystem and the capabilities of the target runtime, it is not guaranteed to be portable. If available, the Subsystem service implementation must first attempt to use the Deployment Manifest to deploy the Subsystem. If the Deployment Manifest is found not to work, for example, the chosen resources do not resolve for the target runtime, then the Subsystem's implementation must fail the installation of the Subsystem.

### 134.15.1 Deployment Headers

A Subsystem can carry descriptive information about its deployment in the Deployment Manifest file contained in its Subsystem Archive under the name `OSGI-INF/DEPLOYMENT.MF`. This specification defines Deployment Manifest headers such as `Deployed-Content`, which Subsystem deployers (typically tools) use to supply deployment information about a Subsystem. A Subsystems implementation must:

- Process the main section of the manifest. Individual section of the manifest are ignored.
- Ignore unknown manifest headers. The Subsystem deployer can define additional manifest headers as needed.
- Ignore unknown attributes and directives.

All specified manifest headers are listed in the following sections, and include example values. All headers are optional, unless specifically indicated.

#### 134.15.1.1 **Deployment-ManifestVersion: 1**

The `Deployment-ManifestVersion` header defines that the deployment manifest follows the rules of a Subsystems Specification. It is 1 (the default) for this version of the specification. Future versions of the Subsystems Specification can define higher numbers for this header.

#### 134.15.1.2 **Subsystem-SymbolicName: com.acme.subsystem.logging**

The `Subsystem-SymbolicName` header specifies a non-localizable name for the Subsystem that the deployment manifest is for. The Subsystem symbolic name together with a version must identify a unique Subsystem though it can be installed multiple times in a framework. See *Validating Subsystem Identity* on page 964.

- 134.15.1.3**      **Subsystem-Version: 1.0**
- The Subsystem-Version header specifies the version of this Subsystem that the deployment manifest is for. See *Validating Subsystem Identity* on page 964.
- 134.15.1.4**      **Deployed-Content: com.acme.logging;type=osgi.bundle;deployed-version=1.0.0**
- The Deployed-Content header lists requirements for the exact resources that are considered to be the contents of this Subsystem. This header identifies the exact versions of the resources listed in the Subsystem-Content header. See *Deployed-Content* on page 965.
- 134.15.1.5**      **Provision-Resource: com.acme.logging;type=osgi.bundle;deployed-version=1.0.0**
- The Provision-Resource header lists requirements for the exact resources to be installed in order to satisfy requirements from the Deployed-Content resources that are not satisfied by the capabilities of the target runtime. See *Provision-Resource* on page 965.
- 134.15.1.6**      **Import-Package: com.acme.api;version="[1.0,1.1]"**
- The Import-Package header lists package requirements for capabilities that are to be imported into a Scoped Subsystem. See *Import-Package* on page 966.
- 134.15.1.7**      **Export-Package: com.acme.api;version=1.0.1**
- The Export-Package header lists package capabilities that are to be exported out of a Scoped Subsystem. See *Export-Package* on page 966.
- 134.15.1.8**      **Require-Bundle: com.acme.logging;version="[1.0, 1.1]"**
- The Require-Bundle header lists bundle requirements for bundle capabilities that are to be imported into a Scoped Subsystem. See *Require-Bundle* on page 967.
- 134.15.1.9**      **Provide-Capability: com.acme.dict; from=nl; to=de; version:Version=1.2**
- The Provide-Capability header declares the capabilities exported for a Scoped Subsystem. See [3] *Resource and Wiring*.
- 134.15.1.10**      **Require-Capability: osgi.ee; filter="(osgi.ee=\*)"**
- The Require-Capability header declares the required capabilities for a Scoped Subsystem. See [3] *Resource and Wiring*.
- 134.15.1.11**      **Subsystem-ImportService: com.acme.service.Logging**
- The Subsystem-ImportService header lists service requirements for service capabilities that are to be imported into a Scoped Subsystem. See *Services* on page 967.
- 134.15.1.12**      **Subsystem-ExportService: com.acme.service.Logging**
- The Subsystem-ExportService header lists service requirements that are matched against service capabilities provided by the Deployed-Content resources. Any matching capabilities are exported out of the Scoped Subsystem.
- 134.15.2**      **Validating Subsystem Identity**
- The Subsystem to which the deployment manifest applies is identified by the Subsystem's symbolic name and version headers. These headers are identical to those specific in the Subsystem manifest. A Subsystem runtime must validate that the headers specified in the deployment manifest match those of the Subsystem manifest, taking into account Subsystem manifest defaulting rules. This allows the two manifests to be managed by teams separately during development or testing whilst ensuring no mistakes have been made when they are brought together for deployment. If the headers do not match, then the runtime must not use the deployment manifest and must fail the installation.



### 134.15.3 Deployed-Content

The Deployed-Content header lists the exact constituents to be installed for the Subsystem. For each mandatory entry in the Subsystem-Content header, there must be a corresponding Deployed-Content entry. If a content resources is identified as optional and there is a corresponding entry in the deployment manifest, then it must be deployed. If there is no corresponding entry in the deployment manifest then no resource must be deployed for it. The Deployed-Content entry identifies the exact version of the constituent whereas the Subsystem-Content entry may specify a version range. Each Deployed-Content entry is identified by symbolic name, version and type (an osgi identity).

Deployed-Content:

```
com.acme.logging;  
    deployed-version=1.0,  
com.acme.persistence;  
    deployed-version=1.1;  
type=osgi.subsystem.composite
```

Each entry must uniquely identify the resource to be provisioned as a constituent of the Subsystem.

The following mandatory matching attributes must be applied to each entry:

- `deployed-version` - The exact version of the resource to be deployed. Deployed version is a specific version, not a version range, hence the use of a new attribute name. There is no default value for this attribute.

The following architected matching attribute as well as any arbitrary matching attributes can be applied to each entry:

`type` - The type of the constituent. It is recommended that a reverse domain name convention is used unless those types and their processing is standardized by the OSGi Alliance (e.g. bundles). The default value is `osgi.bundle`. A Subsystems implementation may support additional types, but the following types must be supported:

- `osgi.bundle`
- `osgi.fragment`
- `osgi.subsystem.application`
- `osgi.subsystem.composite`
- `osgi.subsystem.feature`

The value of this directive must match the type directive for the corresponding entry in the Subsystem-Content header, including taking into account defaulting. If the type does not match, then the installation must fail.

The following directive can be applied to each entry:

- `start-order` - The precedence the constituent should have during the start sequence. Resources with lower start-order values are started before resources with higher values. Resources with the same start-order value may be started sequentially or in parallel. The value of this directive must match the start-order directive for the corresponding entry in the Subsystem-Content header, including taking into account defaulting.

### 134.15.4 Provision-Resource

The Provision-Resource header lists the resources to be provisioned in support of the Subsystem's dependencies. The exact location in the Subsystem hierarchy where the resources are installed is determined by the provision-policy of the Subsystem or its parents.

The Provision-Resource header must result in a transitively complete deployment. For example, if a resource added to Provision-Resource brings in additional unsatisfied requirements, further resources must be added to satisfy these, until there are no unresolved requirements remaining.

Provision resource has one required matching attribute:

- `deployed-version` - The exact version of the resource to be deployed. Deployed version is a specific version, not a version range, hence the use of a new attribute name. There is no default value for this attribute.

The following architected matching attributes as well as any arbitrary matching attributes can be applied to each entry:

`type` - The type of the resource. It is recommended that a reverse domain name convention is used unless those types and their processing is standardized by the OSGi Alliance (e.g. bundles). The default type is `osgi.bundle`. A Subsystems implementation may support additional types, but the following types must be supported:

- `osgi.bundle`
- `osgi.fragment`
- `osgi.subsystem.application`
- `osgi.subsystem.composite`
- `osgi.subsystem.feature`

The list of the Provision-Resource entries is determined by resolving the Subsystem's requirements. The way in which the Subsystem's requirements are resolved is dependent on the Subsystem's sharing policy.

For a Scoped Subsystem the provision resources header must identify a set of resources necessary to satisfy the requirements into the Subsystem that are not satisfied by the target deployment environment. These requirements may be for packages, services, or other types of requirements, and are those identified in the deployment manifest using headers such as `Import-Package` and `Subsystem-ImportService`.

For an Unscoped Subsystem any mandatory requirements that are not satisfied by capabilities provided by the target environment may be satisfied by other constituents or a resource added to the Provision-Resource header. The resolution process for Unscoped Subsystems has no propensity to resolve to capabilities provided by the Subsystem's constituents and so a resource listed in Provision-Resource may provide capabilities that are also provided by a constituent resource.

### 134.15.5 **Import-Package**

Scoped Subsystems describe the exact packages they import in their Deployment Manifests. They do this using the bundle `Import-Package` header. Any packages that match the `Import-Package` statement must be allowed into the Scoped Subsystem by its associated Region's sharing policy.

Unscoped Subsystems have a sharing policy that shares all packages and therefore their deployment manifests do not use this header to describe the sharing of individual packages. If this header is present and the Subsystem is unscoped, then the runtime must fail the installation of the Subsystem.

### 134.15.6 **Export-Package**

Scoped Subsystems describe the exact packages they export in their deployment manifests. They do this using the bundle `Export-Package` header. Any packages that match the `Export-Package` statement must be made available outside the Subsystem by its associated Region's sharing policy.

Unscoped Subsystems have a sharing policy that shares all packages and therefore their deployment manifests do not use this header to describe the sharing of individual packages. If this header

is present and the Subsystem is unscoped, then the runtime must fail the installation of the Subsystem.

### 134.15.7 **Require-Bundle**

Scoped Subsystems can have Require-Bundle requirements satisfied by bundles outside the Subsystem. These bundle requirements are described using the bundle Require-Bundle header. Any bundles that match the Require-Bundle statement must be allowed into the Scoped Subsystem by its associated Region's sharing policy. If a bundle matches the Require-Bundle requirement then it becomes available as a candidate for wiring any Require-Bundle requirements inside the Subsystem. However, any packages the matching bundle provides are not made available to satisfy Import-Package requirements by the Region's sharing policy. If the packages are also required then they must be listed in the deployment manifest's Import-Package header.

Unscoped Subsystems have a sharing policy that shares all bundles and therefore their deployment manifests do not use this header to describe the sharing of specific bundles. If this header is present and the Subsystem is unscoped, then the runtime must fail the installation of the Subsystem.

### 134.15.8 **Services**

Scoped Subsystems can import and export services using the Subsystem-ImportService and Subsystem-ExportService headers respectively. These two headers must conform to the following syntax:

```
Subsystem-ImportService ::= service( ',' service )*
Subsystem-ExportService ::= service ( ',' service )*
service                    ::= qname ( ';' parameter )*
```

Both headers support the following directive:

- **filter** - A filter expression that is used to match against the service properties of services registered using the specified qname of the service's object class. The filter directive is optional. If no filter directive is defined then all services registered using the specified qname match the service statement.

### 134.15.9 **Subsystem-ImportService**

Scoped Subsystems describe the services they import in their deployment manifests. They do this using the Subsystem-ImportService header. Subsystem-ImportService header defines a list of OSGi service filters that are matched against the services visible inside the Scoped Subsystem's parent Region. Each service visible in the Subsystem's parent Region that matches one or more Subsystem-ImportService statements must be allowed into the Scoped Subsystem by its associated Region's sharing policy. The following example imports services registered under the `com.acme.logging.Loginterface` with a service property `threshold=error`.

```
Subsystem-ImportService: com.acme.logging.Log;filter:="(threshold=error)"
```

Unscoped Subsystems have a sharing policy that shares all services and therefore their deployment manifests do not use this header to describe the sharing of specific services. If this header is present and the Subsystem is unscoped, then the runtime must fail the installation of the Subsystem.

### 134.15.10 **Subsystem-ExportService**

Scoped Subsystems describe the services they export in their deployment manifests. They do this using the Subsystem-ExportService header. The Subsystem-ExportService header defines a list of OSGi service filters that are matched against the services visible inside the Scoped Subsystem's Region. Each service visible in the Scoped Subsystem's Region that matches one or more Subsystem-ExportService statements must be allowed by its associated Region's sharing policy into the

Scoped Subsystem's parent Region. The following example exports services registered under the `com.acme.logging.Log` interface with a service property `threshold=error`.

```
Subsystem-ExportService: com.acme.logging.Log; filter:="(threshold=error)"
```

Unscoped Subsystems have a sharing policy that shares all services and therefore their Deployment Manifests do not use this header to describe the sharing of specific services. If this header is present and the Subsystem is unscoped, then the runtime must fail the installation of the Subsystem.

## 134.16 Subsystem Types

Subsystem types simplify the configuration of sharing policies. The type of Subsystem is specified using the `Subsystem-Type` header. Each type has its own default sharing policy, for example, to forbid the sharing of capabilities out, or to share all capabilities in. This specification defines three Subsystem types:

- `osgi.subsystem.application`
- `osgi.subsystem.composite`
- `osgi.subsystem.feature`

Other, non-standard, types are permitted. The specifics of each standard type are describe below.

### 134.16.1 Application

An application is a Scoped Subsystem with a sharing policy associated with what is often considered to be an application. An application does not share (export) any capabilities to other bundles or Subsystems. It also does not explicitly import any capabilities. Any required capabilities that are not satisfied by the application's constituents are automatically shared in (imported) from the parent Subsystem.

A Subsystem is identified as an application by specifying a Subsystem type value of `osgi.subsystem.application` in the Subsystem manifest.

```
Subsystem-Type: osgi.subsystem.application
```

### 134.16.2 Application Deployment

Application Subsystems are not configured using additional requirement or capability headers, such as `Import-Package`. Applications do not export any capabilities. If an application Subsystem contains any capability exports then the Subsystem runtime should log an error and must fail.

Any imported capabilities are derived from the application Subsystem content. An application Subsystem implicitly imports any capabilities required to satisfy requirements from the Subsystem contents that are not satisfied by the capabilities of the Subsystem content.

Unsatisfied mandatory requirements result in a subsystem installation failure. Unsatisfied optional requirements do not. However, implementations must ensure any unsatisfied optional requirements are added to the sharing policy.

#### 134.16.2.1 Package Imports

Application resolution is required to prefer packages provided by content bundles over those provided outside the application. For this reason, the application Subsystem sharing policy only imports packages corresponding to `Import-Package` statements from the content bundles that are not satisfied when resolving the application contents in isolation. This is equivalent to first resolving the `Subsystem-Content` requirements to determine the `Deployed-Content` and then based on this set of resources, determining which `Import-Package` requirements remain unsatisfied.

A deployment manifest for an application Subsystem would list these package imports using the Import-Package header.

#### 134.16.2.2 Service Imports

Application resolution is required to prefer services provided by content bundles over those provided outside the application. For this reason, the application Subsystem sharing policy only imports services required by the Subsystem's content bundles that are not also provided by the content bundles. This specification provides a means of declaratively identifying the services a bundle provides or requires using the Provide-Capability and Require-Capability headers with the `osgi.service` namespace. See *osgi.service Namespace* on page 997

An example of a bundle providing the service and declaring it using the Provide-Capability header is as follows:

```
Provide-Capability: osgi.service;
  objectClass:List<String>="com. foo.MyService";
  uses:="com. foo"
```

Note that declaring a provided service in this manner only affects resolution. It does not affect service visibility at runtime. In other words, a subsystem that imports service `com.acme.Foo` will see all of the corresponding service registrations that its parent sees regardless of whether or not the provider declared this service in the Provide-Capability header.

An example of a bundle requiring a service and declaring the requirement using the Require-Capability header is as follows:

```
Require-Capability: osgi.service;
  filter:="(objectClass=com. foo.MyService)";
  effective:="active"
```

These headers can be hand-written (e.g., to declare programmatic use of an OSGi service) or generated by a tool (e.g., BND) based on a declarative component model configuration (e.g., Declarative Services or Blueprint). A Subsystems implementation must assume these headers, if present, declare all of the service dependencies. Implementations must therefore not search the bundle for additional dependencies from other sources.

A deployment manifest for an application Subsystem would list these service imports using the Subsystem-ImportService header.

#### 134.16.2.3 Bundle Requirements

Application resolution is required to prefer bundle capabilities provided by content bundles over those provided outside the application. For this reason, the application Subsystem sharing policy only requires bundle capabilities corresponding to Require-Bundle statements from the content bundles that are not satisfied when resolving the application contents in isolation. This is equivalent to first resolving the Subsystem-Content requirements to determine the Deployed-Content and then based on this set of resources, determining which Require-Bundle requirements remain unsatisfied.

A Deployment Manifest for an application Subsystem would list these bundle requirements using the Require-Bundle header.

#### 134.16.2.4 Generic Requirements

Application resolution is required to prefer generic capabilities provided by content bundles over those provided outside the application. For this reason, the application Subsystem sharing policy only generic requirements corresponding to Require-Capability statements from the content bundles that are not satisfied by Provide-Capability statements of the content bundles when resolving the application contents in isolation. This is equivalent to first resolving the Subsystem-Content re-

quirements to determine the Deployed-Content and then based on this set of resources, determining which Require-Capability statements remain unsatisfied.

An deployment manifest for an application Subsystem would list these generic requirements using the Require-Capability header.

#### 134.16.2.5 Dependencies

Application Subsystems' implicit requirements are determined as described in the Application Deployment section in *Determining Dependencies* on page 944. Any mandatory requirements from constituents that are not satisfied by capabilities provided by the target environment or other constituents must be satisfied by additional dependencies. The Subsystem runtime is responsible for provisioning these based on the Subsystem's provision policy or those of its scoped parents. If the application Subsystem has an associated deployment manifest, then these resources are described in the Provision-Resource header.

### 134.16.3 Composite

A composite is a Scoped Subsystem with a sharing policy that by default does not share anything with its parent and therefore all sharing is fully explicit. Capabilities, such as packages and services, may be explicitly imported into or exported out of the composite.

A Subsystem is identified as an composite by specifying a Subsystem type value of `osgi.subsystem.composite` in the Subsystem manifest.

Subsystem-Type: `osgi.subsystem.composite`

#### 134.16.3.1 Subsystem Content

The Subsystem-Content header allows version ranges for content resources. For composite Subsystems, this value must be a fixed version range (e.g. `[1.0, 1.0]`) for resources of type `osgi.bundle`, `osgi.fragment`, `osgi.subsystem.application`, `osgi.subsystem.composite`, and `osgi.subsystem.feature`. This is due to the fact that there is an inextricable link between the versions on the explicit import and export statements made on a composite and the chosen versions of the content bundles. Allowing variability in the content versions for these types of resources risks introducing incompatibilities with sharing policy for the composite. If a composite Subsystem does not use strict version ranges then the composite Subsystem must fail to install.

#### 134.16.3.2 Package Imports

A composite Subsystem explicitly states the packages it imports using the Import-Package header. If the composite includes a deployment manifest then the Import-Package header is used to describe these and they must be identical (logically, not syntactically) to the Import-Package headers in the composite's Subsystem manifest. If the imports are not the same then the Subsystem runtime should log an error and must fail the installation.

#### 134.16.3.3 Package Exports

A composite Subsystem explicitly states the packages it exports using the Export-Package header. If the composite includes a deployment manifest then the Export-Package header is used to describe these and they must be identical (logically, not syntactically) to the Export-Package headers in the composite's Subsystem manifest. If the exports are not the same then the Subsystem runtime should log an error and must fail the installation.

#### 134.16.3.4 Service Imports

A composite Subsystem explicitly states the services it imports using the Subsystem-ImportService header (see *Subsystem-ImportService* on page 967 ). For example:

Subsystem-ImportService: `com.acme.logging.Log`

If the composite includes a deployment manifest then the Subsystem-ImportService header is used to describe these and they must be identical (logically, not syntactically) to the Subsystem-ImportService headers in the composite's Subsystem manifest. If the imports are not the same then the Subsystem runtime should log an error and must fail the installation.

#### **134.16.3.5 Service Exports**

A composite Subsystem explicitly states the services it exports using the Subsystem-ExportService header (see *Subsystem-ExportService* on page 967 ). For example:

```
Subsystem-ServiceExport: com.acme.logging.Log
```

If the composite includes a deployment manifest then the Subsystem-ExportService header is used to describe these and they must be identical (logically, not syntactically) to the Subsystem-ExportService headers in the composite's Subsystem manifest. If the exports are not the same then the Subsystem runtime should log an error and must fail the installation.

#### **134.16.3.6 Bundle Requirements**

A composite Subsystem explicitly states the bundles it requires using the Require-Bundle header.

If the composite includes a deployment manifest then the Require-Bundle header is used to describe these and the requirements must be identical (logically, not syntactically) to the Require-Bundle requirements in the composite's Subsystem manifest. If the requirements are not the same then the Subsystem runtime should log an error and must fail the installation.

#### **134.16.3.7 Generic Requirements**

A composite Subsystem explicitly states the generic capabilities it requires using the Require-Capability header.

If the composite includes a deployment manifest then the Require-Capability header is used to describe these and they must be identical (logically, not syntactically) to the Require-Capability headers in the composite's Subsystem manifest. If the capability requirements are not the same then the Subsystem runtime should log an error and must fail the installation.

#### **134.16.3.8 Generic Capabilities**

A composite Subsystem explicitly states the generic capabilities it provides using the Provide-Capability header.

If the composite includes a deployment manifest then the Provide-Capability header is used to describe these and they must be identical (logically, not syntactically) to the Provide-Capability headers in the composite's Subsystem manifest. If the capabilities are not the same then the Subsystem runtime should log an error and must fail the installation.

#### **134.16.3.9 Dependencies**

A composite Subsystem's explicit requirements are stated in the Subsystem manifest. Any mandatory requirements that are not satisfied by capabilities provided by the target environment must be satisfied by additional dependencies. The Subsystem runtime is responsible for provisioning these based on the Subsystem's provision policy or the provision policy of its scoped parents. If the composite Subsystem has an associated deployment manifest, then these resources are described in the Provision-Resource header.

### **134.16.4 Feature**

A feature is an Unscoped Subsystem and therefore provides no isolation of its own. A feature does however always exist in the context of one and only one Region which can restrict the capabilities a feature can see and the extent to which a feature's capabilities are shared.

A Subsystem is identified as a feature by specifying a Subsystem type value of `osgi.subsystem.feature` in the Subsystem manifest.

Subsystem-Type: `osgi.subsystem.feature`

#### 134.16.4.1 **Explicit Requirements and Capabilities**

A feature Subsystem implicitly imports and exports all requirements and capabilities. If the feature Subsystem include any headers designed to modify the sharing policy of a Subsystem, such as `Import-Package` or `Subsystem-ImportService`, then the Subsystem runtime should log an error and must fail the installation of the Subsystem.

#### 134.16.4.2 **Dependencies**

Feature Subsystems implicitly import all capabilities. A Subsystem runtime is responsible for provisioning any dependencies necessary for the Subsystem's constituents to resolve. The calculation of the dependencies can also take into account capabilities provided by the target runtime. The dependencies can include resources that provide capabilities equivalent to those provided by one or more of the constituent resources where the dependency's capability is a considered a better match in the context of some resolution. The Subsystem runtime is responsible for provisioning the dependencies based on the Subsystem's provision policy or the provision policy of its scoped parents. If the feature Subsystem has an associated deployment manifest, then these dependencies are described in the `Provision-Resource` header.

## 134.17 **Weaving Hooks**

Subsystem implementations must ensure that dynamic package imports added by weaving hooks are available to subsystems whose classes have been woven by updating the sharing policies.

Dynamic package imports added by weaving hooks are observed by registering a `WovenClassListener` service and receiving notifications via the `WovenClassListener.modified(WovenClass)` method. The sharing policy must be updated while the woven class is in the `TRANSFORMED` state so that it takes effect before the bundle wiring is updated during the transition to `DEFINED`; otherwise, the class would fail to load.

The bundle containing the woven class can be obtained by calling the `WovenClass.getBundleWiring().getBundle()` method. A bundle might be a constituent of multiple subsystems, but never more than one scoped subsystem. The rest are features, which have no sharing policies to update. It's possible the bundle will not be a constituent of a scoped subsystem. The scoped subsystem, if any, containing the bundle as a constituent is retrieved.

It's possible for a class load request to occur on a bundle in an unresolved subsystem because the framework is free to resolve bundles whenever it desires. A resolved bundle can potentially receive a class load request. For example, a `BundleEventListener` registered with the system bundle context could receive the `RESOLVED` event and, for whatever reason, load a class. Also, a resolved bundle in an unresolved feature might get wired to another bundle. If this is the case, the subsystem must be resolved in order to guarantee the dynamic imports will not effect the resolution and, therefore, potentially create a wiring inconsistent with the deployment manifest. Just as the framework is free to resolve bundles at anytime and for whatever reason, Subsystems implementations are free to resolve subsystems.

The sharing policy is only updated if the dynamic import cannot be completely satisfied from within the subsystem. Note that all dynamic imports with a wildcard must always be added to the sharing policy.



## 134.18 Stopping and Uninstalling Subsystems Implementation

When the Subsystems implementation is stopped all of the installed Subsystems must be persistently stored and present when the Subsystems implementation becomes active again. This includes any bundles that got installed as part of a Subsystem installation. The Subsystems implementation is not required to do any additional cleanup when the Subsystems implementation is stopped or uninstalled. All bundles that got installed as a result of installing a Subsystem may still be installed after stopping or uninstalling the Subsystems implementation bundle. If it is important to clean up the bundles associated with a Subsystem installation then the Subsystem should be uninstalled before uninstalling the Subsystems implementation.

## 134.19 Capabilities

Implementations of the Subsystem Service specification must provide the following capabilities.

- A capability in the `osgi.implementation` namespace declaring the implemented specification to be `osgi.subsystem`. This capability must also declare a `uses` constraint for the `org.osgi.service.subsystem` package. For example:

```
Provide-Capability: osgi.implementation;  
                   osgi.implementation="osgi.subsystem";  
                   version:Version="1.1";  
                   uses:="org.osgi.service.subsystem"
```

This capability must follow the rules defined for the *osgi.implementation Namespace* on page 997.

- A capability in the `osgi.service` namespace representing the [Subsystem](#) service. This capability must also declare a `uses` constraint for the `org.osgi.service.subsystem` package. For example:

```
Provide-Capability: osgi.service;  
                   objectClass:List<String>="org.osgi.service.subsystem.Subsystem";  
                   uses:="org.osgi.service.subsystem"
```

This capability must follow the rules defined for the *osgi.service Namespace* on page 997.

## 134.20 Security

### 134.20.1 Subsystem Permission

The Subsystem Permission is a permission used to grant the right to manage Subsystems with the option to restrict this right to a subset of Subsystems, called targets. For example, an operator can give a bundle the right to only manage Subsystems with a symbolic-name prefix of `com.acme.:`

```
... SubsystemPermission("(name=com.acme.*)",  
...)
```

The actions of Subsystem Permission are fine-grained. They allow a deployer to assign only the permissions that are necessary for a bundle. For example, a bundle may be granted only the permission to start and stop all Subsystems:

```
...SubsystemPermission["*", EXECUTE]
```

Code that needs to check Subsystem Permission must always use the constructor that takes a Subsystem as a parameter: `SubsystemPermission(Subsystem, String)` with a single action.

For example, the implementation of `Subsystem.start` method must check that the caller has access to execute the Subsystem:

```
public class SubsystemImpl implements Subsystem{
    public void start() {
        securityManager.checkPermission(new SubsystemPermission(this, "execute"));
    }
}
```

The Subsystem Permission takes a Filter as its name argument. Filter based permissions are described in [1] *Filter Based Permissions*. Subsystem Archives are not signed and therefore the signer key is not supported. The keys have the following meaning for the Subsystem Permission:

- `id` - The Subsystem ID of a Subsystem. For example (`id=23`)
- `location` - The location of a Subsystem. For example (`location=https://www.acme.com/download/*`)
- `name` - The symbolic name of a Subsystem. For example (`name=com.acme.*`)

The name parameter of the permission can also be a single wildcard character ('\*' \u002a). In that case all Subsystems must match.

## 134.20.2 Actions

The action parameter of Subsystem Permission will specify the subset of privileged Subsystem management operations that are allowed. The actions that are architected are listed below. Future versions of the specification can add additional actions. The given set should therefore not be assumed to be a closed set.

Table 134.3 *Actions*

Action	Used in
CONTEXT	<code>Subsystem.getBundleContext</code>
METADATA	<code>Subsystem.getSubsystemHeaders</code>
	<code>Subsystem.getLocation</code>
LIFECYCLE	<code>Subsystem.install</code>
	<code>Subsystem.uninstall</code>
EXECUTE	<code>Subsystem.start</code>
	<code>Subsystem.stop</code>

## 134.20.3 Required Permissions

A Subsystems implementation must check the caller for the appropriate Subsystem Permission before initiating a Subsystem management operation (e.g. `install`, `start`, `stop`, `uninstall`). Once the Subsystem Permission is checked against the caller the Subsystems implementation will proceed with the actual Subsystem operation. This operation will require a number of other permissions to complete. For example, the Admin Permission will be needed to `install`, `start`, `stop`, and `uninstall` resources of type `osgi.bundle` for a Subsystem. The Subsystems implementation must isolate the caller from such permission checks by use of a proper `doPrivileged` block.

## 134.21 org.osgi.service.subsystem

Subsystem Service Package Version 1.1.

Bundles wishing to use this package must list the package in the Import-Package header of the bundle's manifest. This package has two types of users: the consumers that use the API in this package and the providers that implement the API in this package.

Example import for consumers using the API in this package:

```
Import-Package: org.osgi.service.subsystem; version="[1.1,2.0]"
```

Example import for providers implementing the API in this package:

```
Import-Package: org.osgi.service.subsystem; version="[1.1,1.2]"
```

### 134.21.1 Summary

- **Subsystem** - A subsystem is a collection of resources constituting a logical, possibly isolated, unit of functionality.
- **Subsystem.State** - An enumeration of the possible states of a subsystem.
- **SubsystemConstants** - Defines the constants used by Subsystem service property, manifest header, attribute and directive keys.
- **SubsystemException** - A Subsystem exception used to indicate a problem.
- **SubsystemPermission** - A bundle's authority to perform specific privileged administrative operations on or to get sensitive information about a subsystem.

### 134.21.2 public interface Subsystem

A subsystem is a collection of resources constituting a logical, possibly isolated, unit of functionality.

A subsystem may be *scoped* or *unscoped*. Scoped subsystems are isolated by implicit or explicit sharing policies. Unscoped subsystems are not isolated and, therefore, have no sharing policy. There are three standard types of subsystems.

- **Application** - An implicitly scoped subsystem. Nothing is exported, and imports are computed based on any unsatisfied content requirements.
- **Composite** - An explicitly scoped subsystem. The sharing policy is defined by metadata within the subsystem archive.
- **Feature** - An unscoped subsystem.

Conceptually, a subsystem may be thought of as existing in an isolated region along with zero or more other subsystems. Each region has one and only one scoped subsystem, which dictates the sharing policy. The region may, however, have many unscoped subsystems. It is, therefore, possible to have shared constituents across multiple subsystems within a region. Associated with each region is a bundle whose context may be retrieved from any subsystem within that region. This context may be used to monitor activity occurring within the region.

A subsystem may have children and, unless it's the root subsystem, must have at least one parent. Subsystems become children of the subsystem in which they are installed. Unscoped subsystems have more than one parent if they are installed in more than one subsystem within the same region. The subsystem graph may be thought of as an acyclic digraph [[http://en.wikipedia.org/wiki/Directed\\_acyclic\\_graph](http://en.wikipedia.org/wiki/Directed_acyclic_graph)] with one and only one source vertex, which is the root subsystem. The edges have the child as the head and parent as the tail.

A subsystem has several identifiers.

- Location - An identifier specified by the client as part of installation. It is guaranteed to be unique within the same framework.
- ID - An identifier generated by the implementation as part of installation. It is guaranteed to be unique within the same framework.
- Symbolic Name/Version - The combination of symbolic name and version is guaranteed to be unique within the same region. Although type is not formally part of the identity, two subsystems with the same symbolic names and versions but different types are not considered to be equal.

A subsystem has a well-defined life cycle. Which stage a subsystem is in may be obtained from the subsystem's state and is dependent on which life cycle operation is currently active or was last invoked.

A subsystem archive is a ZIP file having an .esa extension and containing metadata describing the subsystem. The form of the metadata may be a subsystem or deployment manifest, as well as any content resource files. The manifests are optional and will be computed if not present. The subsystem manifest headers may be retrieved in raw or localized forms. There are five standard types of resources that may be included in a subsystem.

- Bundle - A bundle that is not a fragment.
- Fragment - A fragment bundle.
- Application Subsystem - An application subsystem.
- Composite Subsystem - A composite subsystem.
- Feature Subsystem - A feature subsystem.

Resources contained by a subsystem are called constituents. There are several ways a resource may become a constituent of a subsystem:

- A resource is listed as part of the subsystem's content.
- A subsystem resource is a child of the subsystem.
- The subsystem has a provision policy of accept dependencies.
- A bundle resource is installed using the region bundle context.
- A bundle resource is installed using the bundle context of another resource contained by the subsystem.

In addition to invoking one of the install methods, a subsystem instance may be obtained through the service registry. Each installed subsystem has a corresponding service registration. A subsystem service has the following properties.

- ID - The ID of the subsystem.
- Symbolic Name - The symbolic name of the subsystem.
- Version - The version of the subsystem.
- Type - The type of the subsystem.
- State - The state of the subsystem.

Because a subsystem must be used to install other subsystems, a root subsystem is provided as a starting point. The root subsystem may only be obtained as a service and has the following characteristics.

- The ID is o.
- The symbolic name is org.osgi.service.subsystem.root.
- The version matches this specification's version.
- It has no parents.
- All existing bundles, including the system and subsystem implementation bundles, are constituents.

- The type is `osgi.subsystem.application` with no imports.
- The provision policy is `acceptDependencies`.

*Concurrency* Thread-safe

*Provider Type* Consumers of this API must not implement this type

#### **134.21.2.1 public BundleContext getBundleContext()**

- Returns the bundle context of the region within which this subsystem resides.

The bundle context offers the same perspective of any resource contained by a subsystem within the region. It may be used, for example, to monitor events internal to the region as well as external events visible to the region. All subsystems within the same region have the same bundle context. If this subsystem is in a state where the bundle context would be invalid, null is returned.

*Returns* The bundle context of the region within which this subsystem resides or null if this subsystem's state is in `INSTALL_FAILED`, `UNINSTALLED`.

*Throws* `SecurityException`– If the caller does not have the appropriate `SubsystemPermission[this,CONTEXT]`, and the runtime supports permissions.

#### **134.21.2.2 public Collection<Subsystem> getChildren()**

- Returns the child subsystems of this subsystem.

*Returns* The child subsystems of this subsystem. The returned collection is an unmodifiable snapshot of all subsystems that are installed in this subsystem. The collection will be empty if no subsystems are installed in this subsystem.

*Throws* `IllegalStateException`– If this subsystem's state is in `INSTALL_FAILED`, `UNINSTALLED`.

#### **134.21.2.3 public Collection<Resource> getConstituents()**

- Returns the constituent resources of this subsystem.

*Returns* The constituent resources of this subsystem. The returned collection is an unmodifiable snapshot of the constituent resources of this subsystem. If this subsystem has no constituents, the collection will be empty.

*Throws* `IllegalStateException`– If this subsystem's state is in `INSTALL_FAILED`, `UNINSTALLED`.

#### **134.21.2.4 public Map<String,String> getDeploymentHeaders()**

- Returns the headers for this subsystem's deployment manifest.

Each key in the map is a header name and the value of the key is the corresponding header value. Because header names are case-insensitive, the methods of the map must treat the keys in a case-insensitive manner. If the header name is not found, null is returned. Both original and derived headers will be included in the map.

This method must continue to return the headers while this subsystem is in the `INSTALL_FAILED` or `UNINSTALLED` states.

*Returns* The headers for this subsystem's deployment manifest. The returned map is unmodifiable.

*Throws* `SecurityException`– If the caller does not have the appropriate `SubsystemPermission[this,METADATA]`, and the runtime supports permissions.

*Since* 1.1

#### **134.21.2.5 public String getLocation()**

- Returns the location identifier of this subsystem.

The location identifier is the location that was passed to the `install` method of the parent subsystem. It is unique within the framework.

This method must continue to return this subsystem's headers while this subsystem is in the `INSTALL_FAILED` or `UNINSTALLED` states.

*Returns* The location identifier of this subsystem.

*Throws* `SecurityException`— If the caller does not have the appropriate `SubsystemPermission[this,METADATA]`, and the runtime supports permissions.

#### 134.21.2.6 **public Collection<Subsystem> getParents()**

- Returns the parent subsystems of this subsystem.

*Returns* The parent subsystems of this subsystem. The returned collection is an unmodifiable snapshot of all subsystems in which this subsystem is installed. The collection will be empty for the root subsystem; otherwise, it must contain at least one parent. Scoped subsystems always have only one parent. Unscoped subsystems may have multiple parents.

*Throws* `IllegalStateException`— If this subsystem's state is in `INSTALL_FAILED`, `UNINSTALLED`.

#### 134.21.2.7 **public Subsystem.State getState()**

- Returns the current state of this subsystem.

This method must continue to return this subsystem's state while this subsystem is in the `INSTALL_FAILED` or `UNINSTALLED` states.

*Returns* The current state of this subsystem.

#### 134.21.2.8 **public Map<String,String> getSubsystemHeaders(Locale locale)**

*locale* The locale for which translations are desired. The header values are translated according to the specified locale. If the specified locale is null or not supported, the raw values are returned. If the translation for a particular header is not found, the raw value is returned.

- Returns the headers for this subsystem's subsystem manifest.

Each key in the map is a header name and the value of the key is the corresponding header value. Because header names are case-insensitive, the methods of the map must treat the keys in a case-insensitive manner. If the header name is not found, null is returned. Both original and derived headers will be included in the map.

This method must continue to return the headers while this subsystem is in the `INSTALL_FAILED` or `UNINSTALLED` states.

*Returns* The headers for this subsystem's subsystem manifest. The returned map is unmodifiable.

*Throws* `SecurityException`— If the caller does not have the appropriate `SubsystemPermission[this,METADATA]`, and the runtime supports permissions.

#### 134.21.2.9 **public long getSubsystemId()**

- Returns the identifier of this subsystem.

The identifier is a monotonically increasing, non-negative integer automatically generated at installation time and guaranteed to be unique within the framework. The identifier of the root subsystem is zero.

This method must continue to return this subsystem's identifier while this subsystem is in the `INSTALL_FAILED` or `UNINSTALLED` states.

*Returns* The identifier of this subsystem.

#### 134.21.2.10 **public String getSymbolicName()**

- Returns the symbolic name of this subsystem.

The subsystem symbolic name conforms to the same grammar rules as the bundle symbolic name and is derived from one of the following, in order.

- The value of the Subsystem-SymbolicName header, if specified.
- The subsystem URI if passed as the location along with the content to the install method.
- Optionally generated in an implementation specific way.

The combination of subsystem symbolic name and version is unique within a region. The symbolic name of the root subsystem is org.osgi.service.subsystem.root.

This method must continue to return this subsystem's symbolic name while this subsystem is in the INSTALL\_FAILED or UNINSTALLED states.

*Returns* The symbolic name of this subsystem.

#### 134.21.2.11 **public String getType()**

- Returns the type of this subsystem.

This method must continue to return this subsystem's type while this subsystem is in the INSTALL\_FAILED or UNINSTALLED states.

*Returns* The type of this subsystem.

#### 134.21.2.12 **public Version getVersion()**

- Returns the version of this subsystem.

The subsystem version conforms to the same grammar rules as the bundle version and is derived from one of the following, in order.

- The value of the Subsystem-Version header, if specified.
- The subsystem URI if passed as the location along with the content to the install method.
- Defaults to o.o.o.

The combination of subsystem symbolic name and version is unique within a region. The version of the root subsystem matches this specification's version.

This method must continue to return this subsystem's version while this subsystem is in the INSTALL\_FAILED or UNINSTALLED states.

*Returns* The version of this subsystem.

#### 134.21.2.13 **public Subsystem install(String location)**

*location* The location identifier of the subsystem to install.

- Installs a subsystem from the specified location identifier.

This method performs the same function as calling install(String, InputStream) with the specified location identifier and null as the content.

*Returns* The installed subsystem.

*Throws* IllegalStateException– If this subsystem's state is in INSTALLING, INSTALL\_FAILED, UNINSTALLING, UNINSTALLED.

SubsystemException– If the installation failed.

SecurityException– If the caller does not have the appropriate SubsystemPermission[installed subsystem,LIFECYCLE], and the runtime supports permissions.

*See Also* install(String, InputStream)

#### 134.21.2.14 **public Subsystem install(String location,InputStream content)**

*location* The location identifier of the subsystem to be installed.

*content* The input stream from which this subsystem will be read or null to indicate the input stream must be created from the specified location identifier. The input stream will always be closed when this method completes, even if an exception is thrown.

- Installs a subsystem from the specified content.

The specified location will be used as an identifier of the subsystem. Every installed subsystem is uniquely identified by its location, which is typically in the form of a URI. If the specified location conforms to the `subsystem-uri` grammar, the required symbolic name and optional version information will be used as default values.

If the specified content is null, a new input stream must be created from which to read the subsystem by interpreting, in an implementation dependent manner, the specified location.

A subsystem installation must be persistent. That is, an installed subsystem must remain installed across Framework and VM restarts.

All references to changing the state of this subsystem include both changing the state of the subsystem object as well as the state property of the subsystem service registration.

The following steps are required to install a subsystem.

1. If an installed subsystem with the specified location identifier already exists, return the installed subsystem.
2. Read the specified content in order to determine the symbolic name, version, and type of the installing subsystem. If an error occurs while reading the content, an installation failure results.
3. If an installed subsystem with the same symbolic name and version already exists within this subsystem's region, complete the installation with one of the following.
  - If the installing and installed subsystems' types are not equal, an installation failure results.
  - If the installing and installed subsystems' types are equal, and the installed subsystem is already a child of this subsystem, return the installed subsystem.
  - If the installing and installed subsystems' types are equal, and the installed subsystem is not already a child of this subsystem, add the installed subsystem as a child of this subsystem, increment the installed subsystem's reference count by one, and return the installed subsystem.
4. Create a new subsystem based on the specified location and content.
5. If the subsystem is scoped, install and start a new region context bundle.
6. Change the state to `INSTALLING` and register a new subsystem service.
7. Discover the subsystem's content resources. If any mandatory resource is missing, an installation failure results.
8. Discover the dependencies required by the content resources. If any mandatory dependency is missing, an installation failure results.
9. Using a framework `ResolverHook`, disable runtime resolution for the resources.
10. For each resource, increment the reference count by one. If the reference count is one, install the resource. If an error occurs while installing a resource, an install failure results with that error as the cause.
11. If the subsystem is scoped, enable the import sharing policy.
12. Enable runtime resolution for the resources.
13. Change the state of the subsystem to `INSTALLED`.
14. Return the new subsystem.

Implementations should be sensitive to the potential for long running operations and periodically check the current thread for interruption. An interrupted thread should result in a `SubsystemException` with an `InterruptedException` as the cause and be treated as an installation failure.

All installation failure flows include the following, in order.

1. Change the state to `INSTALL_FAILED`.



2. Change the state to UNINSTALLING.
3. All content and dependencies which may have been installed by the installing process must be uninstalled.
4. Change the state to UNINSTALLED.
5. Unregister the subsystem service.
6. If the subsystem is a scoped subsystem then, uninstall the region context bundle.
7. Throw a SubsystemException with the cause of the installation failure.

*Returns* The installed subsystem.

*Throws* `IllegalStateException`– If this subsystem's state is in `INSTALLING`, `INSTALL_FAILED`, `UNINSTALLING`, `UNINSTALLED`.

`SubsystemException`– If the installation failed.

`SecurityException`– If the caller does not have the appropriate `SubsystemPermission[installed subsystem,LIFECYCLE]`, and the runtime supports permissions.

#### **134.21.2.15 public Subsystem install(String location,InputStream content,InputStream deploymentManifest)**

*location* The location identifier of the subsystem to be installed.

*content* The input stream from which this subsystem will be read or null to indicate the input stream must be created from the specified location identifier. The input stream will always be closed when this method completes, even if an exception is thrown.

*deploymentManifest* The deployment manifest to use in lieu of the one in the archive, if any, or a computed one.

- Installs a subsystem from the specified content according to the specified deployment manifest.

This method installs a subsystem using the provided deployment manifest instead of the one in the archive, if any, or a computed one. If the deployment manifest is null, the behavior is exactly the same as in the `install(String, InputStream)` method. Implementations must support deployment manifest input streams in the format described by section 134.2 of the Subsystem Service Specification. If the deployment manifest does not conform to the subsystem manifest (see 134.15.2), the installation fails.

*Returns* The installed subsystem.

*Throws* `IllegalStateException`– If this subsystem's state is in `INSTALLING`, `INSTALL_FAILED`, `UNINSTALLING`, `UNINSTALLED`.

`SubsystemException`– If the installation failed.

`SecurityException`– If the caller does not have the appropriate `SubsystemPermission[installed subsystem,LIFECYCLE]`, and the runtime supports permissions.

*Since* 1.1

#### **134.21.2.16 public void start()**

- Starts this subsystem.

The following table shows which actions are associated with each state. An action of `Wait` means this method will block until a state transition occurs, upon which the new state will be evaluated in order to determine how to proceed. If a state transition does not occur in a reasonable time while waiting then no action is taken and a `SubsystemException` is thrown to indicate the subsystem was unable to be started. An action of `Return` means this method returns immediately without taking any other action.

State	Action
INSTALLING	Wait

INSTALLED	Resolve, Start
INSTALL_FAILED	IllegalStateException
RESOLVING	Wait
RESOLVED	Start
STARTING	Wait
ACTIVE	Return
STOPPING	Wait
UNINSTALLING	IllegalStateException
UNINSTALLED	IllegalStateException

All references to changing the state of this subsystem include both changing the state of the subsystem object as well as the state property of the subsystem service registration.

A subsystem must be persistently started. That is, a started subsystem must be restarted across Framework and VM restarts, even if a start failure occurs.

The following steps are required to start this subsystem.

1. Set the subsystem *autostart setting* to *started*.
2. If this subsystem is in the RESOLVED state, proceed to step 7.
3. Change the state to RESOLVING.
4. Resolve the content resources. A resolution failure results in a start failure with a state of INSTALLED.
5. Change the state to RESOLVED.
6. If this subsystem is scoped, enable the export sharing policy.
7. Change the state to STARTING.
8. For each eligible resource, increment the active use count by one. If the active use count is one, start the resource. All dependencies must be started before any content resource, and content resources must be started according to the specified start order. If an error occurs while starting a resource, a start failure results with that error as the cause.
9. Change the state to ACTIVE.

Implementations should be sensitive to the potential for long running operations and periodically check the current thread for interruption. An interrupted thread should be treated as a start failure with an InterruptedException as the cause.

All start failure flows include the following, in order.

1. If the subsystem state is STARTING then change the state to STOPPING and stop all resources that were started as part of this operation.
2. Change the state to either INSTALLED or RESOLVED.
3. Throw a SubsystemException with the specified cause.

*Throws* SubsystemException– If this subsystem fails to start.

IllegalStateException– If this subsystem's state is in INSTALL\_FAILED, UNINSTALLING, or UNINSTALLED, or if the state of at least one of this subsystem's parents is not in STARTING, ACTIVE.

SecurityException– If the caller does not have the appropriate SubsystemPermission[this,EXECUTE], and the runtime supports permissions.

#### 134.21.2.17

#### **public void stop()**

- Stops this subsystem.

The following table shows which actions are associated with each state. An action of Wait means this method will block until a state transition occurs, upon which the new state will be evaluated

in order to determine how to proceed. If a state transition does not occur in a reasonable time while waiting then no action is taken and a `SubsystemException` is thrown to indicate the subsystem was unable to be stopped. An action of Return means this method returns immediately without taking any other action.

State	Action
INSTALLING	Wait
INSTALLED	Return
INSTALL_FAILED	<code>IllegalStateException</code>
RESOLVING	Wait
RESOLVED	Return
STARTING	Wait
ACTIVE	Stop
STOPPING	Wait
UNINSTALLING	<code>IllegalStateException</code>
UNINSTALLED	<code>IllegalStateException</code>

A subsystem must be persistently stopped. That is, a stopped subsystem must remain stopped across Framework and VM restarts.

All references to changing the state of this subsystem include both changing the state of the subsystem object as well as the state property of the subsystem service registration.

The following steps are required to stop this subsystem.

1. Set the subsystem *autostart setting* to *stopped*.
2. Change the state to STOPPING.
3. For each eligible resource, decrement the active use count by one. If the active use count is zero, stop the resource. All content resources must be stopped before any dependencies, and content resources must be stopped in reverse start order.
4. Change the state to RESOLVED.

With regard to error handling, once this subsystem has transitioned to the STOPPING state, every part of each step above must be attempted. Errors subsequent to the first should be logged. Once the stop process has completed, a `SubsystemException` must be thrown with the initial error as the specified cause.

Implementations should be sensitive to the potential for long running operations and periodically check the current thread for interruption, in which case a `SubsystemException` with an `InterruptedException` as the cause should be thrown. If an interruption occurs while waiting, this method should terminate immediately. Once the transition to the STOPPING state has occurred, however, this method must not terminate due to an interruption until the stop process has completed.

*Throws* `SubsystemException`– If this subsystem fails to stop cleanly.

`IllegalStateException`– If this subsystem's state is in `INSTALL_FAILED`, `UNINSTALLING`, or `UNINSTALLED`.

`SecurityException`– If the caller does not have the appropriate `SubsystemPermission[this,EXECUTE]`, and the runtime supports permissions.

#### 134.21.2.18 **public void uninstall()**

- Uninstalls this subsystem.

The following table shows which actions are associated with each state. An action of Wait means this method will block until a state transition occurs, upon which the new state will be evaluated in order to determine how to proceed. If a state transition does not occur in a reasonable time while

waiting then no action is taken and a `SubsystemException` is thrown to indicate the subsystem was unable to be uninstalled. An action of `Return` means this method returns immediately without taking any other action.

State	Action
INSTALLING	Wait
INSTALLED	Uninstall
INSTALL_FAILED	Wait
RESOLVING	Wait
RESOLVED	Uninstall
STARTING	Wait
ACTIVE	Stop, Uninstall
STOPPING	Wait
UNINSTALLING	Wait
UNINSTALLED	Return

All references to changing the state of this subsystem include both changing the state of the subsystem object as well as the state property of the subsystem service registration.

The following steps are required to uninstall this subsystem after being stopped if necessary.

1. Change the state to `INSTALLED`.
2. Change the state to `UNINSTALLING`.
3. For each referenced resource, decrement the reference count by one. If the reference count is zero, uninstall the resource. All content resources must be uninstalled before any dependencies.
4. Change the state to `UNINSTALLED`.
5. Unregister the subsystem service.
6. If the subsystem is scoped, uninstall the region context bundle.

With regard to error handling, once this subsystem has transitioned to the `UNINSTALLING` state, every part of each step above must be attempted. Errors subsequent to the first should be logged. Once the uninstall process has completed, a `SubsystemException` must be thrown with the specified cause.

Implementations should be sensitive to the potential for long running operations and periodically check the current thread for interruption, in which case a `SubsystemException` with an `InterruptedException` as the cause should be thrown. If an interruption occurs while waiting, this method should terminate immediately. Once the transition to the `UNINSTALLING` state has occurred, however, this method must not terminate due to an interruption until the uninstall process has completed.

*Throws* `SubsystemException`— If this subsystem fails to uninstall cleanly.

`SecurityException`— If the caller does not have the appropriate `SubsystemPermission[this,LIFECYCLE]`, and the runtime supports permissions.

### 134.21.3 **enum Subsystem.State**

An enumeration of the possible states of a subsystem.

These states are a reflection of what constituent resources are permitted to do and not an aggregation of constituent resource states.

#### 134.21.3.1 **INSTALLING**

The subsystem is in the process of installing.

A subsystem is in the `INSTALLING` state when the `install` method of its parent is active, and attempts are being made to install its content resources. If the `install` method completes without exception, then the subsystem has successfully installed and must move to the `INSTALLED` state. Otherwise, the subsystem has failed to install and must move to the `INSTALL_FAILED` state.

**134.21.3.2**      **INSTALLED**

The subsystem is installed but not yet resolved.

A subsystem is in the `INSTALLED` state when it has been installed in a parent subsystem but is not or cannot be resolved. This state is visible if the dependencies of the subsystem's content resources cannot be resolved.

**134.21.3.3**      **INSTALL\_FAILED**

The subsystem failed to install.

A subsystem is in the `INSTALL_FAILED` state when an unrecoverable error occurred during installation. The subsystem is in an unusable state but references to the subsystem object may still be available and used for introspection.

**134.21.3.4**      **RESOLVING**

The subsystem is in the process of resolving.

A subsystem is in the `RESOLVING` state when attempts are being made to resolve its content resources. If the resolve process completes without exception, then the subsystem has successfully resolved and must move to the `RESOLVED` state. Otherwise, the subsystem has failed to resolve and must move to the `INSTALLED` state.

**134.21.3.5**      **RESOLVED**

The subsystem is resolved and able to be started.

A subsystem is in the `RESOLVED` state when all of its content resources are resolved. Note that the subsystem is not active yet.

**134.21.3.6**      **STARTING**

The subsystem is in the process of starting.

A subsystem is in the `STARTING` state when its `start` method is active, and attempts are being made to start its content and dependencies. If the `start` method completes without exception, then the subsystem has successfully started and must move to the `ACTIVE` state. Otherwise, the subsystem has failed to start and must move to the `RESOLVED` state.

**134.21.3.7**      **ACTIVE**

The subsystem is now running.

A subsystem is in the `ACTIVE` state when its content and dependencies have been successfully started.

**134.21.3.8**      **STOPPING**

The subsystem is in the process of stopping.

A subsystem is in the `STOPPING` state when its `stop` method is active, and attempts are being made to stop its content and dependencies. When the `stop` method completes, the subsystem is stopped and must move to the `RESOLVED` state.

**134.21.3.9**      **UNINSTALLING**

The subsystem is in the process of uninstalling.

A subsystem is in the UNINSTALLING state when its uninstall method is active, and attempts are being made to uninstall its constituent and dependencies. When the uninstall method completes, the subsystem is uninstalled and must move to the UNINSTALLED state.

### 134.21.3.10 UNINSTALLED

The subsystem is uninstalled and may not be used.

The UNINSTALLED state is only visible after a subsystem's constituent and dependencies are uninstalled. The subsystem is in an unusable state but references to the subsystem object may still be available and used for introspection.

## 134.21.4 public class SubsystemConstants

Defines the constants used by Subsystem service property, manifest header, attribute and directive keys.

The values associated with these keys are of type String, unless otherwise indicated.

*Concurrency* Immutable

### 134.21.4.1 public static final String DEPLOYED\_CONTENT = "Deployed-Content"

Manifest header identifying the resources to be deployed.

### 134.21.4.2 public static final String DEPLOYED\_VERSION\_ATTRIBUTE = "deployed-version"

Manifest header attribute identifying the deployed version.

### 134.21.4.3 public static final String DEPLOYMENT\_MANIFESTVERSION = "Deployment-ManifestVersion"

Manifest header identifying the deployment manifest version. If not present, the default value is 1.

### 134.21.4.4 public static final String PREFERRED\_PROVIDER = "Preferred-Provider"

Manifest header used to express a preference for particular resources to satisfy implicit package dependencies.

### 134.21.4.5 public static final String PROVISION\_POLICY\_ACCEPT\_DEPENDENCIES = "acceptDependencies"

A value for the provision-policy directive indicating the subsystem accepts dependency resources. The root subsystem has this provision policy.

### 134.21.4.6 public static final String PROVISION\_POLICY\_DIRECTIVE = "provision-policy"

Manifest header directive identifying the provision policy. The default value is rejectDependencies

*See Also* PROVISION\_POLICY\_ACCEPT\_DEPENDENCIES, PROVISION\_POLICY\_REJECT\_DEPENDENCIES

### 134.21.4.7 public static final String PROVISION\_POLICY\_REJECT\_DEPENDENCIES = "rejectDependencies"

A value for the provision-policy directive indicating the subsystem does not accept dependency resources. This is the default value.

### 134.21.4.8 public static final String PROVISION\_RESOURCE = "Provision-Resource"

Manifest header identifying the resources to be deployed to satisfy the dependencies of a subsystem.

### 134.21.4.9 public static final String ROOT\_SUBSYSTEM\_SYMBOLICNAME = "org.osgi.service.subsystem.root"

The symbolic name of the root subsystem.

### 134.21.4.10 public static final String START\_ORDER\_DIRECTIVE = "start-order"

Manifest header directive identifying the start order of subsystem contents. There is no default value. Specified values are of type String and must represent an integer.

- 134.21.4.11**      **public static final String SUBSYSTEM\_CATEGORY = "Subsystem-Category"**  
Manifest header identifying the categories of a subsystem as a comma-delimited list.  
*Since* 1.1
- 134.21.4.12**      **public static final String SUBSYSTEM\_CONTACTADDRESS = "Subsystem-ContactAddress"**  
Manifest header identifying the contact address where problems with a subsystem may be reported; for example, an email address.  
*Since* 1.1
- 134.21.4.13**      **public static final String SUBSYSTEM\_CONTENT = "Subsystem-Content"**  
Manifest header identifying the list of subsystem contents identified by a symbolic name and version.
- 134.21.4.14**      **public static final String SUBSYSTEM\_COPYRIGHT = "Subsystem-Copyright"**  
Manifest header identifying a subsystem's copyright information.  
*Since* 1.1
- 134.21.4.15**      **public static final String SUBSYSTEM\_DESCRIPTION = "Subsystem-Description"**  
Manifest header identifying the human readable description.
- 134.21.4.16**      **public static final String SUBSYSTEM\_DOCURL = "Subsystem-DocURL"**  
Manifest header identifying a subsystem's documentation URL, from which further information about the subsystem may be obtained.  
*Since* 1.1
- 134.21.4.17**      **public static final String SUBSYSTEM\_EXPORTSERVICE = "Subsystem-ExportService"**  
Manifest header identifying services offered for export.
- 134.21.4.18**      **public static final String SUBSYSTEM\_ICON = "Subsystem-Icon"**  
Manifest header identifying the icon URL for the subsystem.  
*Since* 1.1
- 134.21.4.19**      **public static final String SUBSYSTEM\_ID\_PROPERTY = "subsystem.id"**  
The name of the service property for the subsystem ID. The value of this property must be of type Long.
- 134.21.4.20**      **public static final String SUBSYSTEM\_IMPORTSERVICE = "Subsystem-ImportService"**  
Manifest header identifying services required for import.
- 134.21.4.21**      **public static final String SUBSYSTEM\_LICENSE = "Subsystem-License"**  
Manifest header identifying a subsystem's license.  
*Since* 1.1
- 134.21.4.22**      **public static final String SUBSYSTEM\_LOCALIZATION = "Subsystem-Localization"**  
Manifest header identifying the base name of a subsystem's localization entries.  
*Since* 1.1
- 134.21.4.23**      **public static final String SUBSYSTEM\_LOCALIZATION\_DEFAULT\_BASENAME = "OSGI-INF/!icon/subsystem"**  
Default value for the Subsystem-Localization manifest header.

Since 1.1

- 134.21.4.24**      **public static final String SUBSYSTEM\_MANIFESTVERSION = "Subsystem-ManifestVersion"**  
 Manifest header identifying the subsystem manifest version. If not present, the default value is 1.
- 134.21.4.25**      **public static final String SUBSYSTEM\_NAME = "Subsystem-Name"**  
 Manifest header identifying the human readable subsystem name.
- 134.21.4.26**      **public static final String SUBSYSTEM\_STATE\_PROPERTY = "subsystem.state"**  
 The name of the service property for the subsystem state. The value of this property must be of type `Subsystem.State`.
- 134.21.4.27**      **public static final String SUBSYSTEM\_SYMBOLICNAME = "Subsystem-SymbolicName"**  
 Manifest header value identifying the symbolic name for the subsystem. Must be present.
- 134.21.4.28**      **public static final String SUBSYSTEM\_SYMBOLICNAME\_PROPERTY = "subsystem.symbolicName"**  
 The name of the service property for the subsystem symbolic name.
- 134.21.4.29**      **public static final String SUBSYSTEM\_TYPE = "Subsystem-Type"**  
 Manifest header identifying the subsystem type.
- See Also* `SUBSYSTEM_TYPE_APPLICATION`, `SUBSYSTEM_TYPE_COMPOSITE`,  
`SUBSYSTEM_TYPE_FEATURE`
- 134.21.4.30**      **public static final String SUBSYSTEM\_TYPE\_APPLICATION = "osgi.subsystem.application"**  
 The resource type value identifying an application subsystem.  
 This value is used for the `osgi.identity` capability attribute type, the `SUBSYSTEM_TYPE` manifest header and the `SUBSYSTEM_TYPE_PROPERTY` service property.
- 134.21.4.31**      **public static final String SUBSYSTEM\_TYPE\_COMPOSITE = "osgi.subsystem.composite"**  
 The resource type value identifying an composite subsystem.  
 This value is used for the `osgi.identity` capability attribute type, the `SUBSYSTEM_TYPE` manifest header and the `SUBSYSTEM_TYPE_PROPERTY` service property.
- 134.21.4.32**      **public static final String SUBSYSTEM\_TYPE\_FEATURE = "osgi.subsystem.feature"**  
 The resource type value identifying an feature subsystem.  
 This value is used for the `osgi.identity` capability attribute type, the `SUBSYSTEM_TYPE` manifest header and the `SUBSYSTEM_TYPE_PROPERTY` service property.
- 134.21.4.33**      **public static final String SUBSYSTEM\_TYPE\_PROPERTY = "subsystem.type"**  
 The name of the service property for the subsystem type.
- See Also* `SUBSYSTEM_TYPE_APPLICATION`, `SUBSYSTEM_TYPE_COMPOSITE`,  
`SUBSYSTEM_TYPE_FEATURE`
- 134.21.4.34**      **public static final String SUBSYSTEM\_VENDOR = "Subsystem-Vendor"**  
 Manifest header identifying a subsystem's vendor.
- Since 1.1
- 134.21.4.35**      **public static final String SUBSYSTEM\_VERSION = "Subsystem-Version"**  
 Manifest header value identifying the version of the subsystem. If not present, the default value is 0.0.0.



**134.21.4.36**      **public static final String SUBSYSTEM\_VERSION\_PROPERTY = "subsystem.version"**

The name of the service property for the subsystem version. The value of this property must be of type Version.

**134.21.5**      **public class SubsystemException  
extends RuntimeException**

A Subsystem exception used to indicate a problem.

**134.21.5.1**      **public SubsystemException()**

- Construct a Subsystem exception with no message.

**134.21.5.2**      **public SubsystemException(String message)**

*message* The message to include in the exception.

- Construct a Subsystem exception specifying a message.

**134.21.5.3**      **public SubsystemException(Throwable cause)**

*cause* The cause of the exception.

- Construct a Subsystem exception specifying a cause.

**134.21.5.4**      **public SubsystemException(String message,Throwable cause)**

*message* The message to include in the exception.

*cause* The cause of the exception.

- Construct a Subsystem exception specifying a message and a cause.

**134.21.6**      **public final class SubsystemPermission  
extends BasicPermission**

A bundle's authority to perform specific privileged administrative operations on or to get sensitive information about a subsystem. The actions for this permission are:

Action	Methods
context	Subsystem.getBundleContext
execute	Subsystem.start Subsystem.stop
lifecycle	Subsystem.install Subsystem.uninstall
metadata	Subsystem.getSubsystemHeaders Subsystem.getLocation

The name of this permission is a filter expression. The filter gives access to the following attributes:

- location - The location of a subsystem.
- id - The subsystem ID of the designated subsystem.
- name - The symbolic name of a subsystem.

Filter attribute names are processed in a case sensitive manner.

*Concurrency* Thread-safe

**134.21.6.1**      **public static final String CONTEXT = "context"**

The action string context.

**134.21.6.2 public static final String EXECUTE = "execute"**

The action string execute.

**134.21.6.3 public static final String LIFECYCLE = "lifecycle"**

The action string lifecycle.

**134.21.6.4 public static final String METADATA = "metadata"**

The action string metadata.

**134.21.6.5 public SubsystemPermission(String filter,String actions)**

*filter* A filter expression that can use, location, id, and name keys. Filter attribute names are processed in a case sensitive manner. A special value of "\*" can be used to match all subsystems.

*actions* execute, lifecycle, metadata, or context.

- Create a new SubsystemPermission. This constructor must only be used to create a permission that is going to be checked.

Examples:

```
(name=com.acme.*) (location=http://www.acme.com/subsystems/*)
(id>=1)
```

*Throws* IllegalArgumentException– If the filter has an invalid syntax.

**134.21.6.6 public SubsystemPermission(Subsystem subsystem,String actions)**

*subsystem* A subsystem.

*actions* execute, lifecycle, metadata, or context.

- Creates a new requested SubsystemPermission object to be used by the code that must perform checkPermission. SubsystemPermission objects created with this constructor cannot be added to an SubsystemPermission permission collection.

**134.21.6.7 public boolean equals(Object obj)**

*obj* The object being compared for equality with this object.

- Determines the equality of two SubsystemPermission objects.

*Returns* true if obj is equivalent to this SubsystemPermission; false otherwise.

**134.21.6.8 public String getActions()**

- Returns the canonical string representation of the SubsystemPermission actions.

Always returns present SubsystemPermission actions in the following order: execute, lifecycle, metadata, context.

*Returns* Canonical string representation of the SubsystemPermission actions.

**134.21.6.9 public int hashCode()**

- Returns the hash code value for this object.

*Returns* Hash code value for this object.

**134.21.6.10 public boolean implies(Permission p)**

*p* The requested permission.

- Determines if the specified permission is implied by this object. This method throws an exception if the specified permission was not constructed with a subsystem.

This method returns true if the specified permission is a SubsystemPermission AND

- this object's filter matches the specified permission's subsystem ID, subsystem symbolic name, and subsystem location OR
- this object's filter is "\*"

AND this object's actions include all of the specified permission's actions.

Special case: if the specified permission was constructed with "\*" filter, then this method returns true if this object's filter is "\*" and this object's actions include all of the specified permission's actions

*Returns* true if the specified permission is implied by this object; false otherwise.

#### 134.21.6.11      **public PermissionCollection newPermissionCollection()**

- Returns a new PermissionCollection object suitable for storing SubsystemPermissions.

*Returns* A new PermissionCollection object.

## 134.22      **References**

- [1] *Filter Based Permissions*  
OSGi Core, Chapter 2, Filter Based Permissions
- [2] *Core Service Hooks*  
OSGi Core, Chapter 55 Service Hook Service Specification
- [3] *Resource and Wiring*  
OSGi Core, Chapter 6 Resource API Specification
- [4] *Zip File Format*  
The Zip file format as defined by the java.util.zip package.
- [5] *IANA application/vnd.osgi.subsystem*  
[www.iana.org/assignments/media-types/application/vnd.osgi.subsystem](http://www.iana.org/assignments/media-types/application/vnd.osgi.subsystem)
- [6] *RFC 1738 Uniform Resource Locators*  
<http://www.ietf.org/rfc/rfc1738.txt>
- [7] *Uniform Resource Identifiers (URI): Generic Syntax*  
<http://www.ietf.org/rfc/rfc2396.txt>
- [8] *Equinox Region Digraph*  
<http://underlap.blogspot.com/2011/02/stumbling-towards-better-design.html>
- [9] *Open Source initiative*  
<http://www.opensource.org/>

## 134.23      **Changes**

- Specified the translation of subsystem manifest headers.
- Added more informational subsystem manifest headers.
- Specified the interaction between Subsystems and Weaving Hooks for the purposes of supporting dynamically added import packages.

- Added the ability to override the archive's deployment manifest at install time.
- Added the ability to retrieve deployment manifest headers.
- Specified a means for declaratively identifying the services a bundle provides.
- Modified the procedure for determining dependencies to include the capabilities, in a specified order, from all repositories in order to increase the likelihood that a resolution will be found such as when a uses constraint violation would otherwise result.

# 135 Common Namespaces Specification

## Version 1.1

### 135.1 Introduction

A key aspect of the OSGi general dependency model based on requirements and capabilities is the concept of a *Namespace*. A Namespace defines the semantics of a Requirement-Capability pair. The generic model is defined in the [3] *Resources API Specification*. This section defines a number of Namespaces that are not part of the *OSGi Core Release 6* specification. Unless an attribute is specifically overridden, all Namespaces inherit the attributes and directives of the default Namespace as defined [4] *Framework Namespaces Specification*.

Each Namespace is defined with the following items:

- *Name* - the name of an attribute or directive
- *Kind* - Defines where the attribute or directive can be used
  - CA - Capability Attribute
  - CD - Capability Directive
  - RA - Requirement Attribute
  - RD - Requirement Directive
- *M/O* - Mandatory (M) or Optional (O)
- *Type* - The data type
- *Syntax* - Any syntax rules. The syntax refers in general to the syntaxes defined in [5] *General Syntax Definitions* and [6] *Common Headers*.

#### 135.1.1 Versioning

In general, capabilities in a Namespace are versioned using Semantic Versioning. See [7] *Semantic Versioning*. Therefore, a capability will specify a single version and a requirement will specify a version range. See *osgi.extender Namespace* for an example.

For some Namespaces, capabilities are not versioned using Semantic Versioning. The versioning scheme used in those Namespaces will be described in the specification for the Namespace.

### 135.2 osgi.extender Namespace

An *Extender* is a bundle that uses the life cycle events from another bundle, the *extende*, to extend that bundle's functionality when that bundle is active. It can use metadata (headers, or files inside the extende) to control its functionality. Extendees therefore have a dependency on the Extender that can be modeled with the *osgi.extender* Namespace. The definition for this Namespace can be found in the following table and the [ExtenderNamespace](#) class.

Table 135.1 *osgi.extender Namespace*

Name	Kind	M/O	Type	Syntax	Description
osgi.extender	CA	M	String	symbolic-name	A symbolic name for the extender. These names are defined in their respective specifications and should in general use the specification top level package name. For example, org.acme.foo. The OSGi Alliance reserves names that start with "osgi."
version	CA	M	Version	version	A version. This version must correspond to the specification of the extender.

Specifications for extenders (Blueprint, Declarative Services, etc.) should specify the values for these attributes. Extenders that provide such a capability should list the packages that they use in their specification in the uses directive of that capability to ensure class space consistency. For example a Declarative Services implementation could declare its capability with the following manifest header:

```
Provide-Capability: osgi.extender;
    osgi.extender="osgi.component";
    uses:="org.osgi.service.component";
    version:Version="1.3"
```

A bundle that depends on a Declarative Services implementation should require such an extender with the following manifest header:

```
Require-Capability: osgi.extender;
    filter:="(&(osgi.extender=osgi.component)(version>=1.3)(!(version>=2.0)))"
```

Extenders can extend an extendee bundle even if that bundle does not require the extender, unless the extender's specification explicitly forbids this. It is recommended that an extender should only extend a bundle if one of the following is true:

- The bundle's wiring has a required wire for at least one osgi.extender capability with the name of the extender and the first of these required wires is wired to the extender.
- The bundle's wiring has no required wire for an osgi.extender capability with the name of the extender.

Otherwise, the extender should not extend the bundle.

## 135.2.1 Extenders and Framework Hooks

The Framework provides a number of hooks that allow groups of bundles to be scoped. For example, the *Subsystem Service Specification*. An extender may want to extend the complete set of bundles installed in the Framework even when extendee bundles are hidden from the extender. The system bundle context provides a complete view of the bundles and services available in the Framework even if Framework hooks are used to scope groups of bundles. The system bundle context can be used by an extender to track all bundles installed in the Framework regardless of how Framework hooks are used to scope groups of bundles. This is useful in scenarios where several scoped groups contain bundles that require an extender. Instead of requiring an extender to be installed in each scoped group of bundles, a single extender that uses the system bundle context to track extendees can be installed to extend all scoped groups of bundles.

## 135.3 **osgi.contract Namespace**

Products or technologies often have a number of related APIs consisting of a large set of packages. Some IDEs have not optimized for OSGi and requires work for each imported package. In these development environments using modularized systems tends to require a significant amount of manual effort to manage the imported packages.

The `osgi.contract` Namespace addresses this IDE deficiency. It allows a developer to specify a single name and version for a contract that can then be expanded to a potentially large number of packages. For example, a developer can then specify a dependency on Java Enterprise Edition 6 contract that can be provided by an application server.

The `osgi.contract` Namespace provides such a name and binds it to a set of packages with the `uses` constraint. The bundle that declares this contract must then import or export each of the listed packages with the correct versioning. Such a bundle is called a *contract bundle*. The contract bundle must ensure that it is bound to the correct versions of the packages contained within the contract it is providing. If the contract bundle imports the packages which are specified as part of the contract then proper matching attributes must be used to make sure it is bound to the correct versions of the packages.

Additionally, the `osgi.contract` Namespace can be used in cases where API is defined by parties that do not use Semantic Versioning. In those cases, the version of the exported package can be unclear and so it is difficult to specify a meaningful version range for the package import. In such cases, importing the package *without* specifying a version range and specifying a requirement in the `osgi.contract` Namespace can provide a way to create portable bundles that use the API. OSGi has defined contract names for a number of such APIs. See [2] *Portable Java Contract Definitions* for more information.

An `osgi.contract` capability can then be used in the following ways:

- IDEs can use the information in the `uses` directive to make all those packages available on the build path. In this case the developer no longer has to specify each package separately.
- During run time the `uses` clause is used to enforce that all packages in the contract form a consistent class space.

The `uses` directive will make it impossible to get wired to packages that are not valid for the contract. Since the `uses` constrains enforce the consistency, it is in principle not necessary to version the imported packages on client bundles since only the correctly versioned packages can be used. Contracts are aggregates and therefore make clients depend on the whole and all their transitive dependencies, even if the client only uses a single package of the contract.

The recommended way of using contracts is to create a contract bundle that provides the `osgi.contract` capability and imports the packages with their required version range. For example:

```
Provide-Capability: osgi.contract;
    osgi.contract=javax.servlet;
    version:Version=2.5;
    uses:="javax.servlet,javax.servlet.http"
Export-Package:
    javax.servlet;    version="2.5",
    javax.servlet.http; version="2.5"
```

A contract may support multiple versions of a named contract. Such a contract must use a single capability for the contract name that specifies a list of all the versions that are supported. For example, the `javax.servlet` 3.1 contract capability would be specified with the following:

```
Provide-Capability: osgi.contract;
```

```

osgi.contract=JavaServlet;
version:List<Version>="2.5,3.0,3.1";
uses:=
    "javax.servlet,
     javax.servlet.annotation,
     javax.servlet.descriptor,
     javax.servlet.http"
Export-Package:
    javax.servlet;           version="3.1",
    javax.servlet.annotation; version="3.1",
    javax.servlet.descriptor; version="3.1",
    javax.servlet.http;     version="3.1"

```

A client bundle that requires the Servlet 2.5 contract can then have the following manifest:

```

Require-Capability: osgi.contract;
    filter:="(&(osgi.contract=JavaServlet) (version=2.5))",
Import-Package:
    javax.servlet, javax.servlet.http

```

The client bundle will be constrained by the contract's uses constraints and automatically gets the correct packages. In this example, no semantic versioning is used for the contract because the Servlet Specifications do not use semantic versioning (version 3.0 is backward compatible with 2.X).

In this model it is even possible to use the normally not recommended `DynamicImport-Package` header with a wild card since also this header is constrained by the uses constraints. However, using a full wildcard can also dynamically import packages that are not part of the contract. To prevent these unwanted dynamic imports, the exporter could include an attribute on the exports. For example:

```

Require-Capability: osgi.contract;
    filter:="(&(osgi.contract=JavaServlet) (version=2.5))"
DynamicImport-Package:
    *;JavaServlet=contract

```

However, this model requires the exporter to specify an agreed attribute. The contract bundle does not require such coordination; it also allows the package exporters to reside in different and unrelated bundles.

The definition of the `osgi.contract` Namespace is in the following table and in the [ContractNamespace](#) class. See [2] *Portable Java Contract Definitions*.

Table 135.2

*osgi.contract* Namespace

Name	Kind	M/O	Type	Syntax	Description
osgi.contract	CA	M	String	symbolic-name	A symbolic name for the contract.
version	CA	O	Version+	version	A list of versions for the contract. A contract that supports multiple versions must use a single capability with a version attribute that lists all versions supported.
uses	CD	O	String	package-name ( ';' package-name )	For a contract, the standard uses clause is used to indicate which packages are part of the contract. The imports or exports of those packages link these packages to a particular version.

### 135.3.1 Versioning

As the `osgi.contract` Namespace follows the versioning of the associated contract, capabilities in this Namespace are *not* semantically versioned. The associated contracts are often versioned using



marketing or other versioning schemes and therefore the version number cannot be used as an indication of backwards compatibility.

As a result, capabilities in the `osgi.contract` Namespace use a *discrete* versioning scheme. In such a versioning scheme, each version is treated as separate without any implied relation to another version. A capability lists *all* compatible versions. A requirement only selects a single version.

## 135.4 osgi.service Namespace

The Service Namespace is intended to be used for:

- Preventing a bundle from resolving if there is not at least one bundle that potentially can register a specific service.
- Providing a hint to the provisioning agent that the bundle requires a given service.
- Used as template for specifications like Blueprint and Declarative Services to express their provided and referenced services in the Repository model, see the *Repository Service Specification*.

A bundle providing this capability indicates that it can register such a service with at least the given custom attributes as service properties. At resolve time this is a promise since there is no guarantee that during runtime the bundle will actually register such a service; clients must handle this with the normal runtime dependency managers like Blueprint, Declarative Services, or others.

See the following table and the [ServiceNamespace](#) class for this Namespace definition.

Table 135.3

*osgi.service Namespace*

Name	Kind	M/O	Type	Syntax	Description
objectClass	CA	M	List	qname	The fully qualified name of the object class of the service.
*	CA	O	* <String>	(* qname)* *	Custom attributes that will be provided as service properties if they do not conflict with the service properties rules and are not private service properties. Private properties start with a full stop ('.\u002E').

### 135.4.1 Versioning

Capabilities in the `osgi.service` Namespace are *not* versioned. The package of a service's object class is generally versioned and the package can be associated with the capability via the `uses` directive.

## 135.5 osgi.implementation Namespace

The Implementation Namespace is intended to be used for:

- Preventing a bundle from resolving if there is not at least one bundle that provides an implementation of the specified specification or contract.
- Providing `uses` constraints to ensure that bundles which require an implementation of a specification or contract will be wired appropriately by the framework.
- Providing a hint to the provisioning agent that the bundle requires a given specification or contract implementation.
- Used as a general capability Namespace for specifications or contracts to express their provided function in the Repository model, see the *Repository Service Specification*.

A bundle providing this capability indicates that it implements a specification or contract with the specified name and version. For example, the *Asynchronous Service Specification* would provide the following capability:

```
Provide-Capability: osgi.implementation;
  osgi.implementation="osgi.async";
  version:Version="1.0";
  uses:="org.osgi.service.async"
```

See the following table and the [ImplementationNamespace](#) class for this Namespace definition.

Table 135.4 *osgi.implementation Namespace*

Name	Kind	M/O	Type	Syntax	Description
osgi.implementation	CA	M	String	symbolic-name	The symbolic name of the specification or contract. The OSGi Alliance reserves names that start with "osgi.".
version	CA	M	Version	version	The version of the implemented specification or contract.
*	CA	O	*	*	Custom attributes that can be used to further identify the implementation

## 135.6 org.osgi.namespace.contract

Contract Namespace Package Version 1.0.

Bundles should not need to import this package at runtime since all the types in this package just contain constants for capability and requirement namespaces specified by the OSGi Alliance.

### 135.6.1 Summary

- ContractNamespace - Contract Capability and Requirement Namespace.

### 135.6.2 public final class ContractNamespace extends Namespace

Contract Capability and Requirement Namespace.

This class defines the names for the attributes and directives for this namespace. All unspecified capability attributes are of type String and are used as arbitrary matching attributes for the capability. The values associated with the specified directive and attribute keys are of type String, unless otherwise indicated.

*Concurrency* Immutable

#### 135.6.2.1 public static final String CAPABILITY\_VERSION\_ATTRIBUTE = "version"

The capability attribute contains the Version of the specification of the contract. The value of this attribute must be of type Version.

#### 135.6.2.2 public static final String CONTRACT\_NAMESPACE = "osgi.contract"

Namespace name for contract capabilities and requirements.

Also, the capability attribute used to specify the name of the contract.

## 135.7 org.osgi.namespace.extender

Extender Namespace Package Version 1.0.

Bundles should not need to import this package at runtime since all the types in this package just contain constants for capability and requirement namespaces specified by the OSGi Alliance.

### 135.7.1 Summary

- ExtenderNamespace - Extender Capability and Requirement Namespace.

### 135.7.2 public final class ExtenderNamespace extends Namespace

Extender Capability and Requirement Namespace.

This class defines the names for the attributes and directives for this namespace. All unspecified capability attributes are of type String and are used as arbitrary matching attributes for the capability. The values associated with the specified directive and attribute keys are of type String, unless otherwise indicated.

*Concurrency* Immutable

#### 135.7.2.1 public static final String CAPABILITY\_VERSION\_ATTRIBUTE = "version"

The capability attribute contains the Version of the specification of the extender. The value of this attribute must be of type Version.

#### 135.7.2.2 public static final String EXTENDER\_NAMESPACE = "osgi.extender"

Namespace name for extender capabilities and requirements.

Also, the capability attribute used to specify the name of the extender.

## 135.8 org.osgi.namespace.service

Service Namespace Package Version 1.0.

Bundles should not need to import this package at runtime since all the types in this package just contain constants for capability and requirement namespaces specified by the OSGi Alliance.

### 135.8.1 Summary

- ServiceNamespace - Service Capability and Requirement Namespace.

### 135.8.2 public final class ServiceNamespace extends Namespace

Service Capability and Requirement Namespace.

This class defines the names for the attributes and directives for this namespace.

All unspecified capability attributes are of one of the following types:

- String
- Version
- Long

- Double
- List<String>
- List<Version>
- List<Long>
- List<Double>

and are used as arbitrary matching attributes for the capability. The values associated with the specified directive and attribute keys are of type String, unless otherwise indicated.

*Concurrency* Immutable

#### 135.8.2.1 **public static final String CAPABILITY\_OBJECTCLASS\_ATTRIBUTE = "objectClass"**

The capability attribute used to specify the types of the service. The value of this attribute must be of type List<String>.

A ServiceNamespace capability should express a uses constraint for all the packages mentioned in the value of this attribute.

#### 135.8.2.2 **public static final String SERVICE\_NAMESPACE = "osgi.service"**

Namespace name for service capabilities and requirements.

## 135.9 org.osgi.namespace.implementation

Implementation Namespace Package Version 1.0.

Bundles should not need to import this package at runtime since all the types in this package just contain constants for capability and requirement namespaces specified by the OSGi Alliance.

### 135.9.1 Summary

- ImplementationNamespace - Implementation Capability and Requirement Namespace.

#### 135.9.2 **public final class ImplementationNamespace extends Namespace**

Implementation Capability and Requirement Namespace.

This class defines the names for the attributes and directives for this namespace.

This class defines the names for the attributes and directives for this namespace. All unspecified capability attributes are of type String and are used as arbitrary matching attributes for the capability. The values associated with the specified directive and attribute keys are of type String, unless otherwise indicated.

*Concurrency* Immutable

#### 135.9.2.1 **public static final String CAPABILITY\_VERSION\_ATTRIBUTE = "version"**

The capability attribute contains the Version of the specification or contract being implemented. The value of this attribute must be of type Version.

#### 135.9.2.2 **public static final String IMPLEMENTATION\_NAMESPACE = "osgi.implementation"**

Namespace name for "implementation" capabilities and requirements. This is also the capability attribute used to specify the name of the specification or contract being implemented.

A ImplementationNamespace capability should express a uses constraint for the appropriate packages defined by the specification/contract the packages mentioned in the value of this attribute.

## 135.10 References

- [1] *Specification References*  
<http://www.osgi.org/Specifications/Reference>
- [2] *Portable Java Contract Definitions*  
<http://www.osgi.org/Specifications/ReferenceContract>
- [3] *Resources API Specification*  
OSGi Core, Chapter 6 Resource API Specification
- [4] *Framework Namespaces Specification*  
OSGi Core, Chapter 8 Framework Namespaces Specification
- [5] *General Syntax Definitions*  
OSGi Core, General Syntax Definitions
- [6] *Common Headers*  
OSGi Core, Chapter 3, Common Header Syntax
- [7] *Semantic Versioning*  
OSGi Core, Chapter 3, Semantic Versioning

## 135.11 Changes

- Clarified `osgi.extender` Namespace and added a section on the relationship with framework hooks.
- Clarified `osgi.contract` Namespace and examples.
- Added *osgi.implementation Namespace* on page 997.
- Clarified versioning of capabilities in a namespace.



# 136 Resolver Service Specification

## Version 1.0

### 136.1 Introduction

Today very few applications are self contained, the predominant development model is that applications are built from (external) components, which are often open source. Application developers add business logic, glue code, and assemble the diverse components into a resource that provides the desired capabilities when installed in an environment. Designing the assembly has long been a manual and error prone process, partly due to the complexity of external dependencies. Although the direct dependencies are often given, the largest number of dependencies are usually the transitive dependencies: the dependencies of the dependencies. Modern applications can end up with hundreds to thousands of external dependencies. Numbers that make tooling inevitable.

The OSGi framework is the first specification that provides a foundation for automating a significant part of this assembly process. The Requirement-Capability model defined in [3] *Framework Resource API (Core)* provides a dependency model that allows resources to express dependencies, constraints, and capabilities. If a resource's constraints are met it provides capabilities that can satisfy further requirements. The OSGi dependency model is fully generic and is not limited to bundles. Resources can be bundles but also certificates, plugged in devices, etc.

Resolving transitive dependencies is a non-trivial process that requires careful design to achieve the required performance since the underlying problem is NP-complete. OSGi frameworks have always included such resolvers but these were built into the frameworks. They were not usable outside the framework for tooling, for example automatically finding the dependencies of a bundle that needs to be installed.

The number of dependencies is rapidly reaching a threshold where manual methods no longer can provide reliable results. This specification therefore provides the *Resolver service*, a service that can be the base for provisioning, deployment, build, and diagnostic tooling. The service can take a requirement and resolve it to a wiring of resources. For example, with cloud computing a new requirement can be translated into a new OSGi framework instance being started on a node and provisioned with the set of bundles that satisfy the given requirement. The OSGi Resolver service is intended to be a corner stone of such an auto-provisioning tool.

However, the OSGi Resolver service is not limited to these higher end schemes. Build tools can use the Resolver to find components for the build path and/or run time environment and predict the results of installing a set of bundles on a target environment. The OSGi Resolver service is an essential part of a software model where applications are built out of independent components.

This specification is based on the concepts and API defined in the [3] *Framework Resource API (Core)*, [2] *Framework Wiring API (Core)*, and the [1] *Framework Module Layer*. These specifications are required reading for understanding this specification. This specification is for highly specialized use, it is not intended to be used in applications, the Resolver API is a low level service intended for system developers with deep knowledge of the OSGi module layer.

#### 136.1.1 Essentials

- *Transitive* - From a requirement, find a consistent set of resources that satisfy that requirement.
- *Diagnostics* - Provide diagnostic information when no resolution can be found.

- *Scoped Repositories* - Allow the environment to control the repositories to use.
- *Build Tools* - Must be useful in establishing build and run time class paths.
- *Provisioning* - Must be useful to find a set of bundles that can be installed in a system without running into unresolved dependencies.
- *OSGi* - Provide the semantics of all the OSGi namespaces, including the uses constraints.
- *API* - The API for the Resolver must provide the base for the Framework Bundle Wiring API.
- *Performant* - Enable highly performant implementations.
- *Frameworks* - Allow Frameworks to provide their resolver as a service.
- *Scalable* - Allow access to, and use of, very large repositories.

### 136.1.2 Entities

- *Environment* - A container or framework that can install resources and uses a Resolver to wire these resources.
- *Resolve Context* - An interface implemented by the management agent to provide the context of the resolution.
- *Wiring* - Represents the state of a resource's wires, requirements, and capabilities in an environment.
- *Resolver* - A service that can find a set of wires that can be applied to an existing wiring state where a set of initial resources have all their mandatory requirements satisfied.
- *Wire* - Links requirement to a capability.
- *Resource* - An artifact with requirements that need to be provisioned and resolved to provide its capabilities.
- *Requirement* - A necessity for a given resource before it can provide its capabilities; expressed as a filter expression on the attributes of a capability in a given namespace.
- *Capability* - A set of attributes and directives defined by a namespace, describes what a resource provides when resolved.
- *Hosted Capability* - Pairs a resource with a capability to model hosting capabilities in another resource.
- *Namespace* - The type for a capability and requirement.
- *Resolution* - The result of a resolve operation.

Figure 136.1 Class and Service overview

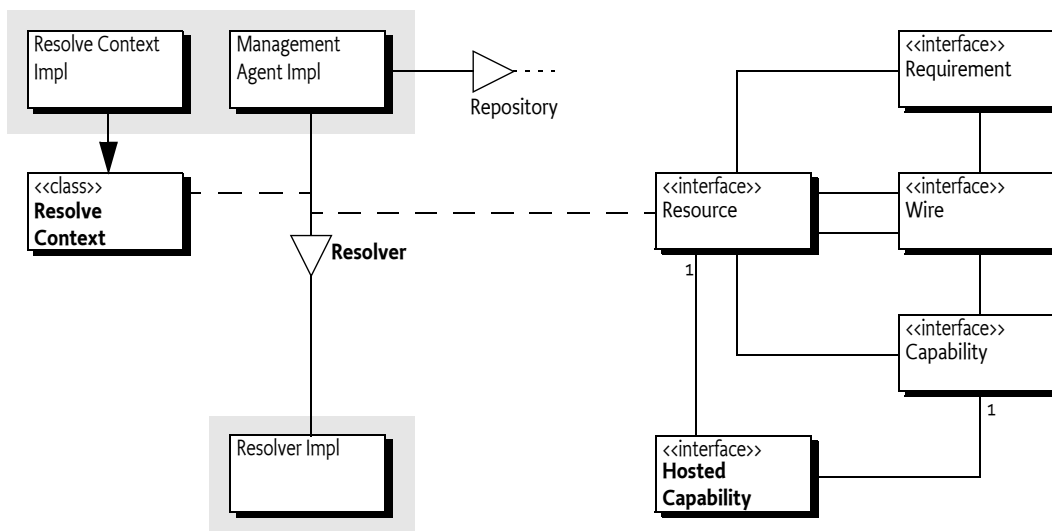



### 136.1.3 Synopsis

The Resolver service can find a complete and consistent set of transitive dependencies starting with an initial set of mandatory and optional resources. Such a set can be used to install resources in the environment from local or remote repositories. To use the Resolver service, the client must provide a [ResolveContext](#) object. This complex object represents the context of a resolution; it provides the initial resources (optional and mandatory), defines a number of namespaces specific policies, and provides the state of the environment.

A resolution can be based on an existing wiring in the environment, for example the current framework state. For the framework, the Resolve Context can find this existing state via the [2] *Framework Wiring API (Core)*. The Resolver must then satisfy all the requirements of the mandatory resources. The Resolver must always ask the Resolve Context to find additional capabilities for the unsatisfied requirements. A capability is always associated with a resource, which is subsequently associated with additional requirements. The final resolution must contain a set of resources that include the initial set of mandatory resources, has no unsatisfied mandatory requirements, and is consistent with the implied constraints. Otherwise it fails.

The Requirement-Capability model is fully generic but provides special semantics through the use of namespaces. The Resolver must implement the standard OSGi namespaces as described in [2] *Framework Wiring API (Core)*, which includes the uses constraints. Part of the semantics of the OSGi namespaces are delegated to the Resolve Context so that it can implement different policies. Singletons, ordering of capabilities, and matching are the responsibility of the Resolve Context; the Resolver never matches a requirement to a capability.

Requirements have an effective directive that indicates in what situations the requirement must be resolved. Also here, the Resolve Context decides if a particular requirement is effective or not. Only effective requirements are wired in the resolution.

Since capabilities are declared by resources that have additional requirements, the Resolver must create a set of resources where all transitive requirements are satisfied or fail with a Resolution Exception. This Resolution Exception can provide additional details why the resolution failed, if possible.

At the end of a successful resolve operation the Resolver returns a `Map<Resource,List<Wire>>`. These wires are a delta on the existing state, if any. The wires can then be used to provision missing resources or to provide diagnostic feedback.

## 136.2 The Resolve Context

Provisioning is the process of providing a framework with the necessary resources to allow it to operate according to set goals. In OSGi terms, this consists of installing bundles and ensuring that the configuration is set up correctly. With OSGi, bundles explicitly describe their capabilities and requirements as manifest headers. This can range from `Export-Package` (a capability) to a generic `Provide-Capability` header.

OSGi Frameworks have a *resolving* stage that ensures requirements are satisfied before a bundle is allowed to provide code to the shared space. As long as the requirements are not met, the bundle remains in the `INSTALLED` state and is thus prohibited from contributing capabilities. Once all the mandatory requirements are met, the bundle becomes `RESOLVED`. That is, a framework combines two decisions when it resolves bundles:

- Find a resolution based on the existing set of installed bundles.
- Move the bundles that have all their mandatory requirements satisfied to the `RESOLVED` state.

The *Resolver service* separates these two stages and thus allows a third party, the *management agent*, to define the *environment* of the resolution. A management agent can interact with the Resolver service

while it is searching for a resolution because the Resolver service calls back the management agent through a [ResolveContext](#) object. The Resolver service will therefore allow the management agent to handle more scenarios, better diagnostics, etc.

The Resolve Context is provided by the management agent, it is an abstract base class and must therefore be extended. It is a non-trivial class to implement since it is tightly coupled to the rules of the environment; it represents the policies of the management agent for that environment. For OSGi framework resolvers, the Resolve Context must understand and implement a part of the OSGi framework namespaces.

With the Resolver service, a management agent can try out resolutions before any bundle can see the result of such a resolution but it can also include extra bundles or other resources on demand. The Resolver service will also allow resolutions to be calculated for other frameworks.

For example, a management agent could use a Resolver service to find missing dependencies and install them on demand from a local directory with bundles. Such a Provisioner could have the following skeleton:

```
public class Provisioner {
    File bundles = ...;
    Map<String,Resource> resources = ...;
    Resolver resolver = ...;
    BundleContext context = ...;

    public void install(String location) {
        Resource resource = resources.get( location );
        if ( resource == null ) error(...);

        try {
            ResolveContextImpl rc = ...
            rc.addMandatory( resource );
            Set<Resource> provision = resolver.resolve( rc ).keySet();

            for ( Resource rb : provision ) {
                String location = getLocation( rb );

                Bundle bundle = context.installBundle( location );
                if ( !isFragment( bundle ) )
                    bundle.start();
            }
        } catch(ResolutionException re) {
            ... // diagnostics
        } catch(BundleException be) {
            ... // diagnostics
        }
    }
}
```

### 136.2.1 Mandatory and Optional Resources

The Resolve Context provides all the parameters for the resolve operation, the Resolver does not maintain any state between invocations. The Resolve Context must therefore provide the mandatory and optional resources, which are essentially the input parameters to the resolve operation. The resolver must find a solution that includes at least the initial mandatory resources and should include the optional resources.

## 136.2.2 Finding Capabilities

The Resolve Context's `findProviders(Requirement)` method must be implemented in such a way that it returns an ordered list of capabilities. The Resolver will treat the order of the capabilities as preferences, the first element is more preferred than a later element. The Resolver cannot guarantee that the wiring obeys this preference since there can be other constraints. However, a Resolver must use this preference order for simple cases and try to use it in more constrained situations.

The Resolver does not make any assumptions, this means that the `findProviders(Requirement)` method must do all the matching. Even though the Resolver gets the mandatory and optional resources it will not search these for capabilities to satisfy requirements. If the `findProviders(Requirement)` method does not search these resources then their capabilities will not be used. The same is true for the existing wiring state used.

Since this section describes the Resolver with respect to a provisioning agent, the set of resources is not limited to the installed set. That is, normally when a framework is resolved the Resolver only has to include installed resources. However, for a provisioning agent it is possible to retrieve external resources. The *Repository Service Specification* on page 889 provides access to resource repositories but a management agent is free to find capabilities by any alternative means.

For resolving an OSGi framework the specifications outlines a number of heuristics that guide the order of wiring bundles and packages:

1. A resource that is already resolved, that is, it is already wired
2. The highest version
3. The lowest bundle id

The Resolver can, and likely will, use the returned list to maintain its internal state during the resolve operation while trying out different potential solutions. It can add and remove capabilities at will. The returned list must therefore be mutable and not reused, after it is returned; it becomes owned by the Resolver. However, the Resolver can call back later with the `insertHostedCapability(List,HostedCapability)` method, giving back the returned list as the first parameter, see *Insert Hosted Capabilities* on page 1010.

For example, assume that all possible resources in the previous example can be gotten with the `getSortedResources` method in the preferred resource order. This list contains all installed resources as well as any potentially installable resources. This list is sorted once on the given ordering criteria, this only has to be done once and not for each `findProviders(Requirement)` method invocation. The following code, which does not order by capability versions, could then be a simple skeleton for the `findProviders(Requirement)` method on the `ResolveContextImpl` inner class:

```
public List<Capability> findProviders(Requirement requirement) {
    List<Capability> result = new ArrayList<Capability>();

    for ( Resource r : getSortedResources() )
        for ( Capability c : r.getCapabilities( null ) )
            if ( match( requirement, c ) )
                result.add( c );

    return result;
}
```

## 136.2.3 Matching

The `findProviders(Requirement)` method is responsible for only returning the capabilities that the management agent wants to be considered by the Resolver. Since the Resolver must never match any requirements to capabilities it allows the management agent to fully control the matching. However, in an OSGi environment the following matching behavior is expected:

- Requirements and capabilities must be in the same namespace.
- Only requirements and capabilities that have no effective directive or have the directive set to resolve should be considered.
- The requirement's filter must match the capability's attributes.
- If the namespace is an `osgi.wiring.*` namespace then the mandatory directive on the capability must be supported. Mandatory attributes are defined with a mandatory directive on a capability, they contain a list of attribute names. Each of these attributes must be used in the filter. Since the filter must be constructed from the corresponding manifest header it is sufficient to search the filter string with a regular expression that detects the usage of an attribute name.

The following example shows a skeleton match method that provides OSGi semantics:

```
boolean match(Requirement r, Capability c){
    if ( !r.getNamespace().equals( c.getNamespace() ) )
        return false;

    String effective = c.getDirectives().get("effective");
    if ( !(effective == null || effective.equals( "resolve" ) ) )
        return false;

    String f = r.getDirectives().get( "filter" );
    if ( f != null ) {
        Filter filter = context.createFilter( f );
        if ( !filter.matches( c.getAttributes() ) )
            return false;
    }

    if ( !c.getNamespace().startsWith( "osgi.wiring." ) )
        return true;

    String mandatory = c.getDirectives().get("mandatory");
    if ( mandatory == null )
        return true;

    List<String> attrs =
        Arrays.asList( mandatory.toLowerCase().split( "\\s*,\\s*" ) );

    Matcher m = FILTER_ASSERT_PATTERN.matcher( f == null ? "" : f );
    while( m.find() )
        attrs.remove(m.group(1)); // the attribute name

    return mandatory.isEmpty();
}
```

### 136.2.4 Repositories

Resolving to provision a framework is different than a framework resolving itself. During provisioning remote repositories can be consulted to find external resources while the framework only resolves a limited set (the installed bundles). These repositories generally contain magnitudes more bundles than what is installed in a framework.

Repositories do not implement any namespace specific semantics and therefore do not understand any directives. Repositories only verify the requirement's filter (if any) against the capability's attributes. The Resolver expects the Resolve Context to do the namespace specific matching. The *Repository Service Specification* on page 889 provides the details for a service that abstracts a Requirement-Capability aware repository.

With such a repository service the `findProviders(Requirement)` method can be implemented as follows:

```
List<Repository> repositories = new CopyOnWriteArrayList<Repository>();

void addRepository( Repository repository) { repositories.add(repository);}
void removeRepository(Repository repository){ repositories.remove(repository);}

public List<Capability> findProviders( Requirement requirement) {
    List<Capability> result = new ArrayList<Capability>();

    // previous findProviders that searches the initial resources

    for ( Repository repository : repositories ) {
        Collection<Capability> capabilities = repository.findProviders(
            Collections.singleton( requirement ) ).get( requirement);
        for ( Capability c : capabilities )
            if ( match( requirement, c ) )
                result.add( c );
    }
    return result;
}
```

### 136.2.5 Existing Wiring State

The Resolver service always creates a list of wires that should be added to an existing state. To get the existing state, the `ResolveContext` interface specifies the `getWirings()` method. This method must return the existing state as a `Map<Resource,Wiring>`. A `Wiring` is an object that reflects the wired state of a resource in the environment. From this object, all declared and hosted capabilities and requirements can be found, including their wires if any. The Resolver needs this existing state to create a consistent resolution. For example, uses constraints require access to the existing state.

The Resolver service API is based on the generic Requirement-Capability model. This API is implemented by the OSGi framework to reflect its internal wiring, see [2] *Framework Wiring API (Core)*. When the Resolver service is used for an OSGi framework then the Resolve Context can provide the existing wiring state based on the Framework Wiring API. The interfaces used in the `org.osgi.framework.wiring` package all extend their counterpart in the `org.osgi.resource` package (the generic model). For example, the `BundleCapability` interface extends the `Capability` interface.

The framework wiring API models all the power and complexities of the OSGi framework. One of those aspects is *removal pending*. Each installed bundle is represented by one or more bundle revisions. Each bundle revision is a `Resource` object but only one is the current bundle revision. During a resolve operation a framework can actually wire to the current bundle revision but is not forbidden to also select the pending removal bundle revisions. The Resolve Context must therefore decide if it provides only the current bundle revisions or all. The best policy solution in this case is to always refresh after a (batch) of install operations and only resolve when there are no pending-removal bundle revisions. However, certain management agents attempt to manage a system that is in this half-way state and will then be required to include the pending-removal revisions.

The following example code shows a possible implementation of the `getWirings()` method. It only uses the current wiring and ignores removal pending bundle revisions:

```
public Map<Resource,Wiring> getWirings(){
    Map<Resource,Wiring> wirings = new HashMap<Resource,Wiring>();

    for ( Bundle b : context.getBundles() ) {
        BundleRevision revision = b.adapt( BundleRevision.class);
        if ( revision != null ) {
```

```

        Wiring wiring = revision.getWiring();
        if ( wiring != null )
            wirings.put( revision, wiring );
    }
}
return wirings;
}

```

### 136.2.6 Effective

The Resolver service is designed to work with OSGi frameworks but the scope is broader; its design allows many alternative usages. The effective directive on the capabilities and requirements is meant to allow requirements and capabilities to be effective in different phases. The default is resolve, the value for an OSGi framework resolving process. Bundles and other OSGi defined artifacts must declare their capabilities and requirements in the resolve effective time to be considered by an OSGi resolver.

However, Resolvers can use the effective directive to run the Resolver at other times than the standard OSGi framework resolve. For example, it could be possible to define an *active time* to resolve the service dependencies.

For this reason, the Resolver is designed to be agnostic for this directive, it will always ask the [ResolveContext](#) if a requirement is effective. It does this with the [isEffective\(Requirement\)](#) method. Since the Resolver service never matches requirements to capabilities it is also up to the Resolve Context to decide how to treat the effective directive. For an OSGi resolve operation, capabilities should also have an effective time value of resolve (or not set since resolve is the default).

To make requirements effective during the resolving of bundles it will be necessary to implement the [isEffective\(Requirement\)](#) method similar to:

```

public boolean isEffective( Requirement requirement ) {
    String e = requirement.getDirectives().get( "effective" );
    return e==null || "resolve".equals( e );
}

```

### 136.2.7 Insert Hosted Capabilities

One of the complex aspects of resolving for an OSGi framework is handling fragments. For fragments, the declared capabilities are going to be hosted by their hosts. The Requirement and Capability objects have a [getResource](#) method that returns the associated resource. For hosted capabilities and requirements this must be the hosting resource and for others the declaring resource.

The [HostedCapability](#) interface defines the interface for allowing the hosting resource to be returned instead of the declaring resource. Since the Resolver service creates these Hosted Capabilities the Resolver needs a way to add them to the lists of capabilities returned from [findProviders\(Requirement\)](#). The Resolver service cannot add them itself since this list has a preference order, the Resolver service must therefore ask the Resolve Context to insert this new capability to allow the Resolve Context to maintain the desired order.

The Resolve Context must therefore implement an [insertHostedCapability\(List,HostedCapability\)](#) method. The given list must have been returned earlier from a [findProviders\(Requirement\)](#) method invocation. The Resolve Context must find the appropriate position to insert the [HostedCapability](#) object, insert it, and return the index of the inserted object.

It is the responsibility of the Resolve Context to find the proper position. In *Finding Capabilities* on page 1007 it was discussed how the [findProviders\(Requirement\)](#) method must return an ordered list. The [insertHostedCapability\(List,HostedCapability\)](#) has that same responsibility.

The following example shows how the Hosted Capability is inserted based on the index of the hosted resource's index in the sorted list of resources the management agent maintained. The example

iterates through the capabilities and compares the index of sorted resources to indicate preference. If it finds a capability from a resource that was later in the list of sorted resources then it inserts it at that position. A real implementation should also take the version of the capability into account.

```
public int insertHostedCapability(
    List<Capability> caps, HostedCapability hc ) {

    List<Resource> resources = getSortedResources();
    int index = resources.indexOf( hc.getResource() );

    for ( int i =0; i < caps.size(); i++ ) {
        Capability c = caps.get( i );
        int otherIndex = resources.indexOf( c.getResource() );
        if ( otherIndex > index ) {
            caps.add( i, hc );
            return i;
        }
    }
    caps.add( hc );
    return caps.size()-1;
}
```

### 136.2.8 Fragments

Fragments are resources that have an `osgi.wiring.host` requirement that must match a capability from one or more host bundles. However, for example an `Export-Package` in a fragment must be merged with its attached hosts. These capabilities and requirements from namespaces that appear as if they come from the host bundle are called *hosted*.

Since fragments are not required by the host bundle, there will be no resource requiring the fragment bundles. The Resolver will therefore never ask the Resolve Context to provide fragments. However, fragments will require their hosts. A Resolver should attach any fragments available in a resolution to suitable hosts.

Since fragments will not be discovered from their hosts, it can be necessary to run the resolver twice in certain scenarios. The first resolve operation finds a resolution that is then used to find fragments that could be attached to the included bundles. These fragments can then be added to set of mandatory or optional resources for an additional resolve operation.

Fragments can of course also be found by the normal finding of capabilities.

### 136.2.9 Singleton Capabilities

A resource can be marked as a *singleton*. A singleton resource has the `singleton` directive set to true on the `osgi.identity` capability. A singleton resource *conflicts* with another singleton resource if:

- They have the same `osgi.identity`, and
- They have the same type, and
- They have a different or identical version.

This constraint is not enforced by the Resolver service to give more flexibility to management agents. The Resolve Context must ensure that it does not return capabilities from conflicting singleton resources from the `findProviders(Requirement)` method. When the Resolver is used with a limited set of resources then it is possible to enumerate all singletons ahead of time and use permutations. However, when repositories are used an incremental method works better because the scope is so much larger.

When the `findProviders(Requirement)` method is called for a requirement that selects a capability declared in a singleton then it is likely that repositories will return multiple versions of this single-

ton including the resource with the highest available version for conflicting resources. It is therefore possible to maintain a white list of singletons incrementally.

Once the `findProviders(Requirement)` method has created a result list, it is possible to prune this list of conflicting singletons. This can be an incremental process, the first time a singleton is encountered in such a list of capabilities the highest version can be *selected* as the singleton. Other singletons that are in that list or come in other invocations of `findProviders(Requirement)` can then no longer provide capabilities. For example:

```
Map<String,Resource> whitelist = new HashMap<String,Resource>();

void prune( List<Capability> list ) {
    Map<String,Resource> singletons = new HashMap<String,Resource>();

    for ( Capability c : list) {
        Resource r = c.getResource();
        Version now = getVersion( r );
        String identity = getIdentity( r );

        if ( isSingleton( r ) && !whitelist.containsKey(identity ) ) {
            Resource selected = singletons.get( identity );
            if ( selected == null )
                singletons.put( identity, r );
            else {
                Version old = getVersion( selected );
                if ( now.compareTo( old ) > 0 )
                    singletons.put( identity, r );
            }
        }
    }

    this.whitelist.putAll( singletons );

    for ( Iterator<Capability> i=list.iterator(); i.hasNext();) {
        Capability c = i.next();
        Resource r = c.getResource();
        String identity = getIdentity( r );
        Resource selected = this.whitelist.get( identity );
        if ( selected != null && !selected.equals( r ) )
            i.remove();
    }
}
```

### 136.2.10 Diagnostics

The Resolver service throws a `ResolutionException` when the resolve operation cannot find a solution. This Exception provides the standard human readable message. However, there is also the `getUnresolvedRequirements()` method. With this method it is possible to find what requirements could not be matched. Though this is very useful in many cases it must be realized that resolving is a complicated process. It is not possible to establish the exact set of missing requirements because any unresolved resolution can have many, different, sets of unresolved requirements. This is an intrinsic part of the resolution problem. There is also no guarantee that providing capabilities that satisfy these requirements will give a successful resolution. There could still be other constraints that cannot be satisfied. In general, the Resolve Context can already detect any unresolved mandatory requirements when it cannot find a matching capability in the `findProviders(Requirement)` method.

That said, the `getUnresolvedRequirements()` can often point to a potential solution.



### 136.2.11 Complexity

Implementing a Resolve Context is a non-trivial task that requires extensive knowledge of the OSGi framework, especially the module layer. Though this section contains numerous code examples, they are not sufficient to implement a real Resolve Context since this would require too much code for a specification.

## 136.3 Resolver Service

The *Resolver* service is an interface to a generic constraint solver based on the *Require-Capability* model defined in [3] *Framework Resource API (Core)*. This model defines a constraint-solving language that is used by the Framework, see [1] *Framework Module Layer*, to create the mesh of class loaders. However, the Resolver service has been designed to be useful in solving other types of constraint problems.

The task of the Resolver is to find a *resolution*. The resolve method returns a *delta* on an *existing wiring state*. The total of existing wiring state and the applied delta is the resolution. The delta is a set of wires between requirements and capabilities.

### 136.3.1 Variables

The `resolve(ResolveContext)` method uses a Resolve Context to provide the context and parameters of the resolution. During the resolution process the Resolver service can callback the Resolve Context to retrieve the following information:

$R_m$	Collection<Resource>	<code>getMandatoryResources()</code>
$R_o$	Collection<Resource>	<code>getOptionalResources()</code>
$C_{env}$	Map<Requirement,List<Capability>>	Combined answers from the <code>findProviders(Requirement)</code> method
$Q_{eff}$	Collection<Requirement>	Set of effective requirements as defined by the <code>isEffective(Requirement)</code> method
$X$	Map<Resource,Wiring>	An existing Wiring state, <code>getWirings()</code>

The Resolver service returns the following:

$D$	Map<Resource,List<Wire>>	The resolution, a delta on the existing state
-----	--------------------------	-----------------------------------------------

The `resolve(ResolveContext)` method returns a resolution  $D$  that is a delta on the existing Wiring state  $X$ . It is up to the Resolve Context to ensure that the delta  $D$  is installed. In for example the OSGi framework the framework hooks can be used to guide the framework's resolving process.

### 136.3.2 Resolving

The goal of the Resolver is to provide a set of wires between a set of *resolved* resources. A resource is resolved when all its *mandatory* and *effective* requirements are satisfied by capabilities from resolved resources. A Resolver must not return wires between resources that have unsatisfied mandatory requirements.

A *mandatory* requirement has a resolution directive that is not set or that is set to mandatory. The *effectiveness* of a requirement is defined by the Resolve Context, a Resolver service must call the `isEffective(Requirement)` method to establish if a requirement is effective for a given resolve operation. A Resolver must never create a wire from a requirement that is not effective.

To find a resolution, the Resolver must use the Resolve Context to find *candidate* capabilities for the requirements declared in the resources that it needs to resolve. A candidate capability is a capability that *satisfies* the requirement. From the perspective of the Resolver service, a requirement is satis-

fied by a capability when that capability is returned from the [findProviders\(Requirement\)](#) method. A Resolver has no alternative way to find out if a requirement is satisfied by a capability and must therefore not make any assumptions about matching. Any matching rules like for example the `osgi.wiring.*` mandatory directive must be implemented by the Resolve Context. A Resolve Context must always return the same capabilities during a resolving operation when given the same requirement.

Since the resolver cannot match requirements and capabilities the Resolve Context must return capabilities for all possible resources, this must include:

- The given mandatory resources  $R_m$
- The given optional resources  $R_o$
- The existing Wiring state  $X$

It can include additional resources that were indirectly returned through the [findProviders\(Requirement\)](#) method.

The existing wiring  $X$  provides an existing set of constraints that the Resolver service must abide by. It can get this state with the [getWirings\(\)](#) method. The purpose of the existing state is to ensure that any wires are compatible with existing wiring. For an OSGi framework it is crucial that the uses constraints are maintained for the resolution, see [1] *Framework Module Layer*.

The Resolver service can wire new requirements to existing capabilities but it can never create wires for an existing requirement from the existing wiring.

If the Resolver service attaches a hosted resource like a fragment, and thereby needs to add new [HostedCapability](#) objects to a previously returned list from [findProviders\(Requirement\)](#) then it must call the Resolve Context's [insertHostedCapability\(List, HostedCapability\)](#) method.

Fragments can be attached from resolved resources or from resources that declare the capabilities returned from [findProviders\(Requirement\)](#), that is,  $C_{env}$ .

This specification does not define the detailed rules and constraints associated with resolving; these rules are defined in their namespaces. An OSGi Resolver service must support at least all namespaces defined in [4] *Framework Namespace (Core)* except for the following directives:

- mandatory - Mandatory attributes on the `osgi.wiring.*` namespaces must be implemented by the Resolve Context. The Resolve Context should not return capabilities from [findProviders\(Requirement\)](#) unless the rules of the OSGi mandatory directive are followed.
- singleton - Singletons are not implemented by the Resolver, the Resolve Context must not return capabilities from [findProviders\(Requirement\)](#) from conflicting singleton resources.
- effective - The Resolve Context decides what requirements are effective in the [isEffective\(Requirement\)](#) method.

A Resolver service must support the uses constraints and any applicable rule defined in the [1] *Framework Module Layer* for the `osgi.wiring.*` namespaces.

The Resolver must return a delta wiring to the existing state (potentially empty) or throw an Exception. The resolution:

- Must contain all mandatory resources  $R_m$  as provided by [getMandatoryResources\(\)](#).
- Must have all resources resolved.
- Must have no wired capabilities that are declared or hosted in resources that are not resolved.
- Should include optional resources  $R_o$  as provided by [getOptionalResources\(\)](#).

### 136.3.3 Resolution Exception

If the Resolver cannot find a solution or it runs into problems then it must throw a Resolution Exception, which is a Runtime Exception.

The `ResolutionException` provides the `getUnresolvedRequirements()` method. If the resolution failed then it is possible that this was caused because it failed to find matches for certain requirements. The information in this method can be very helpful to find a solution that will work, however, there are a number of caveats.

Resolving is an NP-complete problem. For these problems there exists no algorithm that can infer a solution from the desired outcome. Therefore, the Resolver tries a potential solution and if that solution does not match the constraints it will backtrack and attempt another solution. An unavoidable aspect of such solutions is that it is impossible to pin-point a single failure point if the algorithm fails to find a solution, in general the algorithm gives up after having exhausted its search space. However, during its search it might have been very close to a solution, for example it only missed a single requirement, but its final failure missed many requirements.

The implication is that the reported missing requirements neither give a guarantee for a resolution when satisfied nor indicate that this is the smallest set of missing requirements.

Therefore, `getUnresolvedRequirements()` is intended for human consumption and not for automated solutions.

## 136.4 Security

### 136.4.1 Resolving

The Resolver service is a pure function that has no state. The Resolve Context maintains the state and is therefore the actor that requires most permissions. In general, it will require access to the Wiring API and Repositories.

Since the Resolver requires no external access it does not have to be a trusted service. Resolve Contexts that support security must ensure that the callbacks are executed in a privileged block.

### 136.4.2 Minimum Implementation Permissions

```
PackagePermission[org.osgi.service.resolver, IMPORT]
ServicePermission[...Resolver, REGISTER ]
```

### 136.4.3 Minimum Using Permissions

```
PackagePermission[org.osgi.service.repository, IMPORT]
PackagePermission[org.osgi.service.resolver, IMPORT]
PackagePermission[org.osgi.resource, IMPORT]
PackagePermission[org.osgi.framework.wiring, IMPORT]
PackagePermission[org.osgi.framework.namespaces, IMPORT]
ServicePermission[...Resolver, GET ]
... likely needs AdaptPermissions and ServicePermission[...Repository, GET]
```

## 136.5 org.osgi.service.resolver

Resolver Service Package Version 1.0.

Bundles wishing to use this package must list the package in the Import-Package header of the bundle's manifest. This package has two types of users: the consumers that use the API in this package and the providers that implement the API in this package.

Example import for consumers using the API in this package:

```
Import-Package: org.osgi.service.resolver; version="[1.0,2.0)"
```

Example import for providers implementing the API in this package:

```
Import-Package: org.osgi.service.resolver; version="[1.0,1.1]"
```

### 136.5.1 Summary

- `HostedCapability` - A capability hosted by a resource.
- `ResolutionException` - Indicates failure to resolve a set of requirements.
- `ResolveContext` - A resolve context provides resources, options and constraints to the potential solution of a resolve operation.
- `Resolver` - A resolver service resolves the specified resources in the context supplied by the caller.

### 136.5.2 public interface `HostedCapability` extends `Capability`

A capability hosted by a resource.

A `HostedCapability` is a `Capability` where the `getResource()` method returns a `Resource` that hosts this `Capability` instead of declaring it. This is necessary for cases where the declaring `Resource` of a `Capability` does not match the runtime state. For example, this is the case for fragments attached to a host. Most fragment declared capabilities and requirements become hosted by the host resource. Since a fragment can attach to multiple hosts, a single capability can actually be hosted multiple times.

*Concurrency* Thread-safe

*Provider Type* Consumers of this API must not implement this type

#### 136.5.2.1 public `Capability` `getDeclaredCapability()`

- Return the `Capability` hosted by the `Resource`.

*Returns* The `Capability` hosted by the `Resource`.

#### 136.5.2.2 public `Resource` `getResource()`

- Return the `Resource` that hosts this `Capability`.

*Returns* The `Resource` that hosts this `Capability`.

### 136.5.3 public class `ResolutionException` extends `Exception`

Indicates failure to resolve a set of requirements.

If a resolution failure is caused by a missing mandatory dependency a resolver may include any requirements it has considered in the resolution exception. Clients may access this set of dependencies via the `getUnresolvedRequirements()` method.

Resolver implementations may extend this class to provide extra state information about the reason for the resolution failure.

#### 136.5.3.1 public `ResolutionException(String message,Throwable cause,Collection<Requirement> unresolvedRequirements)`

*message* The message.

*cause* The cause of this exception.

*unresolvedRequirements* The unresolved mandatory requirements from mandatory resources or null if no unresolved requirements information is provided.

- Create a `ResolutionException` with the specified message, cause and unresolved requirements.

**136.5.3.2 public ResolutionException(String message)**

*message* The message.

- Create a ResolutionException with the specified message.

**136.5.3.3 public ResolutionException(Throwable cause)**

*cause* The cause of this exception.

- Create a ResolutionException with the specified cause.

**136.5.3.4 public Collection<Requirement> getUnresolvedRequirements()**

- Return the unresolved requirements, if any, for this exception.

The unresolved requirements are provided for informational purposes and the specific set of unresolved requirements that are provided after a resolve failure is not defined.

*Returns* A collection of the unresolved requirements for this exception. The returned collection may be empty if no unresolved requirements information is available.

**136.5.4 public abstract class ResolveContext**

A resolve context provides resources, options and constraints to the potential solution of a resolve operation.

Resolve Contexts:

- Specify the mandatory and optional resources to resolve. The mandatory and optional resources must be consistent and correct. For example, they must not violate the singleton policy of the implementer.
- Provide capabilities that the Resolver can use to satisfy requirements via the `findProviders(Requirement)` method
- Constrain solutions via the `getWirings()` method. A wiring consists of a map of existing resources to wiring.
- Filter requirements that are part of a resolve operation via the `isEffective(Requirement)`.

A resolver may call the methods on the resolve context any number of times during a resolve operation using any thread. Implementors should ensure that this class is properly thread safe.

Except for `insertHostedCapability(List, HostedCapability)`, the resolve context methods must be *idempotent*. This means that resources must have constant capabilities and requirements and the resolve context must return a consistent set of capabilities, wires and effective requirements.

*Concurrency* Thread-safe

**136.5.4.1 public ResolveContext()****136.5.4.2 public abstract List<Capability> findProviders(Requirement requirement)**

*requirement* The requirement that a resolver is attempting to satisfy. Must not be null.

- Find Capabilities that match the given Requirement.

The returned list contains Capability objects where the Resource must be the declared Resource of the Capability. The Resolver can then add additional HostedCapability objects with the `insertHostedCapability(List, HostedCapability)` method when it, for example, attaches fragments. Those HostedCapability objects will then use the host's Resource which likely differs from the declared Resource of the corresponding Capability.

The returned list is in priority order such that the Capabilities with a lower index have a preference over those with a higher index. The resolver must use the `insertHostedCapability(List, HostedCapa-`

bility) method to add additional Capabilities to maintain priority order. In general, this is necessary when the Resolver uses Capabilities declared in a Resource but that must originate from an attached host.

Each returned Capability must match the given Requirement. This means that the filter in the Requirement must match as well as any namespace specific directives. For example, the mandatory attributes for the `osgi.wiring.package` namespace.

*Returns* A list of Capability objects that match the specified requirement.

#### 136.5.4.3 **public Collection<Resource> getMandatoryResources()**

- Return the resources that must be resolved for this resolve context.

The default implementation returns an empty collection.

*Returns* A collection of the resources that must be resolved for this resolve context. May be empty if there are no mandatory resources. The returned collection may be unmodifiable.

#### 136.5.4.4 **public Collection<Resource> getOptionalResources()**

- Return the resources that the resolver should attempt to resolve for this resolve context. Inability to resolve one of the specified resources will not result in a resolution exception.

The default implementation returns an empty collection.

*Returns* A collection of the resources that the resolver should attempt to resolve for this resolve context. May be empty if there are no optional resources. The returned collection may be unmodifiable.

#### 136.5.4.5 **public abstract Map<Resource,Wiring> getWirings()**

- Returns the wirings for existing resolved resources.

For example, if this resolve context is for an OSGi framework, then the result would contain all the currently resolved bundles with each bundle's current wiring.

Multiple calls to this method for this resolve context must return the same result.

*Returns* The wirings for existing resolved resources. The returned map is unmodifiable.

#### 136.5.4.6 **public abstract int insertHostedCapability(List<Capability> capabilities,HostedCapability hostedCapability)**

*capabilities* The list returned from `findProviders(Requirement)`. Must not be null.

*hostedCapability* The `HostedCapability` to insert in the specified list. Must not be null.

- Add a `HostedCapability` to the list of capabilities returned from `findProviders(Requirement)`.

This method is used by the Resolver to add Capabilities that are hosted by another Resource to the list of Capabilities returned from `findProviders(Requirement)`. This function is necessary to allow fragments to attach to hosts, thereby changing the origin of a Capability. This method must insert the specified `HostedCapability` in a place that makes the list maintain the preference order. It must return the index in the list of the inserted `HostedCapability`.

*Returns* The index in the list of the inserted `HostedCapability`.

#### 136.5.4.7 **public abstract boolean isEffective(Requirement requirement)**

*requirement* The Requirement to test. Must not be null.

- Test if a given requirement should be wired in the resolve operation. If this method returns false, then the resolver should ignore this requirement during the resolve operation.

The primary use case for this is to test the effective directive on the requirement, though implementations are free to use any effective test.

*Returns* true if the requirement should be considered as part of the resolve operation.

## 136.5.5 public interface Resolver

A resolver service resolves the specified resources in the context supplied by the caller.

*Concurrency* Thread-safe

*Provider Type* Consumers of this API must not implement this type

### 136.5.5.1 public Map<Resource,List<Wire>> resolve(ResolveContext context) throws ResolutionException

*context* The resolve context for the resolve operation. Must not be null.

- Resolve the specified resolve context and return any new resources and wires to the caller.

The resolver considers two groups of resources:

- Mandatory - any resource in the mandatory group must be resolved. A failure to satisfy any mandatory requirement for these resources will result in throwing a ResolutionException
- Optional - any resource in the optional group may be resolved. A failure to satisfy a mandatory requirement for a resource in this group will not fail the overall resolution but no resources or wires will be returned for that resource.

The resolve method returns the delta between the start state defined by `ResolveContext.getWirings()` and the end resolved state. That is, only new resources and wires are included.

The behavior of the resolver is not defined if the specified resolve context supplies inconsistent information.

*Returns* The new resources and wires required to satisfy the specified resolve context. The returned map is the property of the caller and can be modified by the caller.

*Throws* ResolutionException– If the resolution cannot be satisfied.

## 136.6 References

- [1] *Framework Module Layer*  
OSGi Core, Chapter 3 Module Layer
- [2] *Framework Wiring API (Core)*  
OSGi Core, Chapter 7 Bundle Wiring API Specification
- [3] *Framework Resource API (Core)*  
OSGi Core, Chapter 6 Resource API Specification
- [4] *Framework Namespace (Core)*  
OSGi Core, Chapter 8 Framework Namespaces Specification





# 137 REST Management Service Specification

## Version 1.0

### 137.1 Introduction

Cloud computing is a continuing trend in the IT industry. Due to its service model which embraces dynamism as opposed to masking it, OSGi appears to be an ideal base for building scalable and dependable applications for the cloud where changes in the deployment, network topology, and service availability are the norm rather than the exception. One of the possible scenarios for OSGi to be successfully applied to cloud computing is using it in a Platform as a Service (PaaS) spirit. Users write their bundles and can deploy them to a provided OSGi instance running in the cloud. This, however, requires the platform provider to expose the OSGi management API to the end user and make them available through a network protocol. One of the popular approaches in cloud computing to remote communication is the use of RESTful web services.

Representational State Transfer (REST) is the architectural style of the world wide web. It can be described as a set of constraints that govern the interactions between the main components of the Internet. Recently, REST style interaction has gained popularity as a architecture for web services (RESTful web services), mainly to overcome the perceived complexity and verbosity of SOAP-based web services. This specification describes a REST interface for framework management, client-side Java and JavaScript APIs, and an extension mechanism through which other bundles can contribute their own RESTful management APIs and make them discoverable by clients.

#### 137.1.1 Essentials

- *Client-Server* - A separation of concern between the entity responsible for the user-interaction (client) and the other entity (server) responsible for data storage. For instance, in the original world wide web the browser is the client rendering and presenting the content delivered by one or more web servers. As a result, web content becomes more portable and content providers more scalable.
- *Stateless* - State is entirely kept at the client side. Therefore, every request must contain all state required for the server to accomplish the transaction and deliver content. The main rationale behind this design constraint is to again improve the scalability since in a pure stateless design the server resources are not burdened with maintaining any client state. Another perceived advantage is that the failure models of stateless interactions is simpler and fault tolerance easier to achieve.
- *Cacheable* - Content marked as cacheable can be temporarily stored and used to immediately answer future equivalent requests and improve efficiency and reduce network utilization and access latencies. Due to the end-to-end principle, caches can be placed where necessary, e.g., at the client (forward-proxy), at the server side (backward-proxy), or somewhere in-between for example in a content delivery network. Content marked as non-cacheable must be freshly retrieved with every request even in the presence of caches.
- *Layered* - Layering introduces natural boundaries to coupling since every layer only accesses the services provided by the lower layer and provides services to the next higher layer.

- *Uniform Interface* - Generality of component interfaces provides a natural decoupling of implementation and interface. REST furthermore encourages the separation of identifiable resources (addressing) and their representation (content delivery).

### 137.1.2 Entities

- *Resource* - A resource is an abstract piece of information that can be addressed by a resource identifier. The mapping of a resource to a concrete set of entities can vary over time.
- *Representation* - A representation is a sequence of bytes plus associated meta-data that describe the state of a resource. The data format of a representation is called the media-type. Every concrete representation of a resource is just one of arbitrarily many possible representations. The selection of a concrete representation of a resource can be made according to the media types supported by both the client and the server.
- *REST Management Service* - The management service exposes a REST API for remotely managing an OSGi framework through the network in a lightweight and portable fashion.
- *Client* - The client is a machine using the management service by issuing REST requests through the network. It can do so either directly or indirectly, i.e., through client-side libraries using the REST calls internally.

### 137.1.3 Synopsis

The manageable entities of an OSGi framework are mapped to resources accessible through resource identifiers. These identifiers are relative to the (usually externally accessible) root URL of the management service. Clients can either discover this root URL or receive it through configuration. Subsequently, a client is able to introspect the state of the framework and perform management operations.

The internal state of a framework resource is expressed and transmitted as a representation. The format of the representation is subject to a mutual agreement between client and management service regarding media types commonly supported by both endpoints. This specification describes two representation formats: JSON and XML.

## 137.2 Interacting with the REST Management Service

The REST Management Service is not a traditional OSGi service and it does not appear in the service registry. Its purpose is to expose a management interface to clients which can perform operations on the framework through a network connection. Therefore, it is ideally suited for situations where the user of an OSGi framework does not have direct access to the machine it is running on, a typical situation in Infrastructure as a Service (IaaS) or Platform as a Service (PaaS). However, even in other domains having a lightweight and easily accessible management solution can be of benefit, e.g., for embedded devices. The advantage of REST is that it uses HTTP and therefore does usually not interfere with firewalls. Furthermore, the REST format is easily embeddable into client-side scripting technologies like JavaScript and can be consumed in web browsers.

Much of the value of the REST Management Service lies in client-side libraries which can use the REST protocol and interact with the OSGi framework through the Management Service. Therefore, this specification contains API for two clients, a Java Client API and a JavaScript Client API.

### 137.2.1 Resource Identifier Overview

The REST Management Service comprises of a set of resources that can be retrieved and in some cases also modified through REST requests. These resources need to be made available under well-defined paths so that clients can interact with them. As the initial entry point a client receives a URL to the REST Management Service. This can be done, e.g., as part of the creation of a cloud-based OSGi

framework, and the precise mechanism would be proprietary to the cloud platform used. Relative to this URL the client can access the resources through the following resource identifiers:

```
framework
framework/state
framework/startlevel
framework/bundles

framework/bundles/representations

framework/bundle/{bundleid}
framework/bundle/{bundleid}/state
framework/bundle/{bundleid}/startlevel
framework/bundle/{bundleid}/header
framework/services

framework/services/representations

framework/service/{serviceid}
```

framework/bundle/o/state is an alias for framework/state

Extensions to the REST Management Service can be discovered by visiting the Extensions Resource at:

```
extensions
```

For more details on the extension mechanism see *Extending the REST Management Service* on page 1035

### 137.2.2 Filtering Results

The bundles, bundles/representations, services, and services/representations resources allow the use of a query parameter which specifies a filter to restrict the result set. The filter expression follows the Core Specifications *Framework Filter Syntax*; see [1] *Framework Filter Syntax*.

Filters on services are matched against the service attributes. The query parameter is of the form:

```
framework/services?filter=ldap-filter
```

Filters on bundles are matched against the attributes of capabilities in the respective namespaces. Filters on bundles have the form:

```
framework/bundles?namespace1=ldap-filter1&namespace2=ldap-filter2&...
```

If multiple capabilities for a given namespace are present, then a filter succeeds when one of these capabilities matches. When multiple filter expressions across namespaces are given, these are combined with the *and* operator.

### 137.2.3 Content Type Matching

Resources can present themselves through different representation variants. An implementation of this specification must support at least the JSON representation and the XML representation of resources. Clients can support a subset of representations. Matching the clients capabilities to understand certain representation formats with the servers supported formats follows the typical HTTP pattern of content negotiation and requires the client to set corresponding HTTP Accept headers for supported formats in the form of their media types. This specification describes the format and media types for representations in JSON and XML format in *Representations* on page 1029.

Implementations of the REST Management Service offering different variants of representations must return the best matching variant based on the HTTP accept header. In addition, they must re-

spect the file extensions defined for the different media types as specified in the respective IETF RFC (e.g., ".xml" as specified in IETF RFC 3032 and ".json" as specified in IETF RFC 4627). If a file extension is appended to the resource, an implementation must return the variant mandated by the file extension provided that it supports this content type.

## 137.3 Resources

The framework and its state is mapped to a set of different resources. Each resource is accessible through a resource identifier, as summarized in *Resource Identifier Overview* on page 1022.

### 137.3.1 Framework Startlevel Resource

framework/startlevel

The startlevel resource represents the active start level of the framework. It supports the GET and PUT requests.

#### 137.3.1.1 GET

The GET request retrieves a *Framework Startlevel Representation* from the REST management service. The request can return the following status codes:

- 200 (OK): the request has been served successfully and the body of the response is a startlevel representation.
- 406 (NOT ACCEPTABLE): the REST management service does not support any of the requested representations.

#### 137.3.1.2 PUT

The PUT request sets the target framework startlevel. The body of the request needs to be a *Framework Startlevel Representation*. The request can return the following status codes:

- 204 (NO CONTENT): the request was received and valid. The framework will asynchronously start to adjust the framework startlevel until the target startlevel has been reached.
- 415 (UNSUPPORTED MEDIA TYPE): the request had a media type that is not supported by the REST management service.
- 400 (BAD REQUEST): the REST management service received an `IllegalArgumentException` when trying to adjust the framework startlevel, e.g., because the requested startlevel was zero or negative.

### 137.3.2 Bundles Resource

framework/bundles

The bundles resource represents the list of all bundles installed on the managed framework. It supports the GET request and two syntactically different forms of POST requests which are used to install new bundles to the framework.

Results for this resource can be filtered as described in *Filtering Results* on page 1023.

#### 137.3.2.1 GET

The GET request retrieves a *Bundle List Representation* from the REST management service. The request can return the following status codes:

- 200 (OK): the request has been served successfully and the body of the response is a bundle list representation.
- 406 (NOT ACCEPTABLE): the REST management service does not support any of the requested representations.

**137.3.2.2 POST with Location String**

The POST request installs a new bundle to the managed framework and thereby logically appends it to the bundles resource. The new bundle to be installed is referenced by a location string which is passed as the body of the request. In order to disambiguate the request from the other form of POST, the content type must be set to text/plain. In practice, the location string is usually a URL. Since the framework will use the location retrieving the physical bundle, it needs to be accessible from the remotely managed framework and not necessarily from the managing client.

The management service implementation must check if the result of the install request matches the requested bundle since the OSGi framework will return an existing bundle object as the return value of an install call if there was already one with the same location string installed. One way of doing it is comparing the last modification timestamp. A detected collision is indicated to the requesting clients through an error code 409.

The body of the response is *Bundle Representation* of the newly installed bundle. The following status codes can be returned:

- 200 (OK): the bundle has been successfully installed and the body of the response contains the URI.
- 400 (BAD REQUEST): the REST management service received a *BundleException* when trying to install. The body of the message is a *Bundle Exception Representation* describing the reason why the installation did not succeed.
- 409 (CONFLICT): there is already a bundle installed with the same location string.

**137.3.2.3 POST with Bundle**

This variant of the POST request uploads the bundle as the body of the request. The media type of the request should be set to application/vnd.osgi.bundle which must be supported by all REST management services. Implementations are free to accept other media types for this request with the exception of text/plain. For instance, they can opt to additionally support application/zip or application/x-jar.

Clients should use the HTTP Content-Location field to set a bundle location. If no content location is given, REST management service implementations must generate a unique location string in order to avoid unintended collisions between unrelated bundles.

The body of the response is *Bundle Representation* of the newly installed bundle. The following status codes can be returned:

- 200 (OK): the bundle has been successfully installed and the body of the response contains the URI.
- 400 (BAD REQUEST): the REST management service received a *BundleException* when trying to install. The body of the message is a *Bundle Exception Representation* describing the reason why the installation did not succeed.
- 409 (CONFLICT): there is already a bundle installed with the same location string.

**137.3.3 Bundles Representations Resource**

framework/bundles/representations

**137.3.3.1 GET of the Representations**

The bundles resource returns a list of the URIs of all bundles installed on the framework. For clients interested in the details of multiple bundles there is also the possibility to retrieve the bundle representation of each installed bundle with a single request through the *bundles/representations* resource.

The body of the response is a *Bundle Representations List Representation*. The request can return the following status codes:

Results for this resource can be filtered as described in *Filtering Results* on page 1023.

- 200 (OK): the request has been served successfully and the body of the response is a bundle list representation.
- 406 (NOT ACCEPTABLE): the REST management service does not support any of the requested representations.

### 137.3.4 Bundle Resource

framework/bundle/{bundleid}

The bundle resource represents a single, distinct bundle in the system. Hence, it has to be qualified by a bundle id. The resource supports the GET, two variants of PUT, and the DELETE requests.

#### 137.3.4.1 GET

The GET request retrieves a *Bundle Representation* from the REST management service. The request can return the following status codes:

- 200 (OK): the request has been served successfully and the body of the response is a bundle representation.
- 404 (NOT FOUND): there is not bundle with the given bundle id.
- 406 (NOT ACCEPTABLE): the REST management service does not support any of the requested representations.

#### 137.3.4.2 PUT with Location String

The PUT request updates the bundle with a new version, referenced by a location string which is passed as the body of the request. In order to disambiguate the request from the other form of PUT, the content type must be set to text/plain. The same rationale applies as for *POST with Location String* and *POST with Bundle* on page 1025, if a location string is given it must point to a location reachable by the managed framework. If no location string is passed as the body of the request, the framework will perform an update based on the existing bundle's location string.

The body of the response is *Bundle Representation* of the updated bundle. The following status codes can be returned:

- 204 (NO CONTENT): the request was received and valid and the framework has issued the update.
- 400 (BAD REQUEST): the REST management service received a *BundleException* when trying to update. The body of the message is a *Bundle Exception Representation* describing the reason why the update did not succeed.
- 404 (NOT FOUND): there is not bundle with the given bundle id.

#### 137.3.4.3 PUT with Bundle

The PUT request updates the bundle with a new version, uploaded as the body of the request. The media type of the request should be set to application/vnd.osgi.bundle which must be supported by all REST management services. Implementations are free to accept other media types for this request with the exception of text/plain. For instance, they can opt to additionally support application/zip or application/x-jar.

The body of the response is *Bundle Representation* of the updated bundle. The following status codes can be returned:

- 204 (NO CONTENT): the request was received and valid and the framework has issued the update.
- 400 (BAD REQUEST): the REST management service received a *BundleException* when trying to update. The body of the message is a *Bundle Exception Representation* describing the reason why the update did not succeed.
- 404 (NOT FOUND): there is not bundle with the given bundle id.

**137-3-4-4 DELETE**

The DELETE request uninstalls the bundle from the framework.

The body of the response is *Bundle Representation* of the uninstalled bundle, where the bundle state will be UNINSTALLED. The following status codes can be returned:

- 204 (NO CONTENT): the request was received and valid and the framework has uninstalled the bundle.
- 400 (BAD REQUEST): the REST management service received a *BundleException* when trying to uninstall. The body of the message is a *Bundle Exception Representation* describing the reason why the uninstallation did not succeed.
- 404 (NOT FOUND): there is not bundle with the given bundle id.

**137-3-5 Bundle State Resource**

framework/bundle/{bundleid}/state

The bundle state resource represents the internal state of an installed bundle qualified through its bundle id. It supports the GET and PUT requests.

**137-3-5-1 GET**

The GET request retrieves a *Bundle State Representation* from the REST management service. The request can return the following status codes:

- 200 (OK): the request has been served successfully and the body of the response is a bundle state representation.
- 404 (NOT FOUND): there is not bundle with the given bundle id.
- 406 (NOT ACCEPTABLE): the REST management service does not support any of the requested representations.

**137-3-5-2 PUT**

The PUT request sets the target state for the given bundle. This can, e.g., be state=32 for transitioning the bundle to started, or state=4 for stopping the bundle and transitioning it to resolved. The body of the request needs to be a *Bundle State Representation*. Not all state transitions are valid. The body of the response is the new *Bundle State Representation*. The request can return the following status codes:

- 200 (OK): the request was received and valid. The framework has performed a state change and the new bundle state is contained in the body.
- 400 (BAD REQUEST): the REST management service received a *BundleException* when trying to perform the state transition. The body of the message is a *Bundle Exception Representation* describing the reason why the operation did not succeed.
- 402 (PRECONDITION FAILED): the requested target state is not reachable from the current bundle state or is not a target state. An example such state is the STOPPING state.
- 404 (NOT FOUND): there is not bundle with the given bundle id.
- 415 (UNSUPPORTED MEDIA TYPE): the request had a media type that is not supported by the REST management service.

**137-3.6 Bundle Header Resource**

framework/bundle/{bundleid}/header

The bundle header resource represents manifest header of a bundle which is qualified by its bundle id. It can only be read through a GET request.

**137.3.6.1****GET**

The GET request retrieves a *Bundle Header Representation* from the REST management service. The raw header value is used unless an Accept-Language header is set on the HTTP request. If multiple accepted languages are set only the first is used to localize the header. The request can return the following status codes:

- 200 (OK): the request has been served successfully and the body of the response is a bundle header representation.
- 404 (NOT FOUND): there is not bundle with the given bundle id.
- 406 (NOT ACCEPTABLE): the REST management service does not support any of the requested representations.

**137.3.7****Bundle Startlevel Resource**

framework/bundle/{bundleid}/startlevel

The bundle startlevel resource represents the start level of the bundle qualified by its bundle id. It supports the GET and PUT requests.

**137.3.7.1****GET**

The GET request retrieves a *Bundle Startlevel Representation* from the REST management service. The request can return the following status codes:

- 200 (OK): the request has been served successfully and the body of the response is a bundle startlevel representation.
- 404 (NOT FOUND): there is not bundle with the given bundle id.
- 406 (NOT ACCEPTABLE): the REST management service does not support any of the requested representations.

**137.3.7.2****PUT**

The PUT request sets the target bundle startlevel. The body of the request needs to be a *Bundle Startlevel Representation*, however only the startLevel property is used. The request can return the following status codes:

- 200 (OK): the request was received and valid. The REST management service has changed the bundle startlevel according to the target value. The body of the response is the new bundle startlevel representation.
- 400 (BAD REQUEST): either the target startlevel state involved invalid values, e.g., a startlevel smaller or equal to zero and the REST management service got an *IllegalArgumentException*, or the REST management service received a *BundleException* when trying to perform the startlevel change. In the latter case, the body of the message is a *Bundle Exception Representation* describing the reason why the operation did not succeed.
- 404 (NOT FOUND): there is not bundle with the given bundle id.
- 415 (UNSUPPORTED MEDIA TYPE): the request had a media type that is not supported by the REST management service.

**137.3.8****Services Resource**

framework/services

The services resource represents the set of all services available on the framework, optionally constrained by a filter expression. It is read-only and therefore only supports the GET request.

Results for this resource can be filtered as described in *Filtering Results* on page 1023.



**137.3.8.1****GET**

The GET request retrieves a *Service List Representation* from the REST management service. The request can return the following status codes:

- 200 (OK): the request has been served successfully and the body of the response is a service list representation.
- 400 (BAD REQUEST): the provided filter expression was not valid.
- 406 (NOT ACCEPTABLE): the REST management service does not support any of the requested representations.

**137.3.9****Services Representations Resource**

framework/services/representations

**137.3.9.1****GET of the Representations**

The services resource returns a list of the URIs of all services registered on the framework. For clients interested in the details of multiple services there is also the possibility to retrieve the service representation of each available service with a single request through the *services/representations* resource. The body of the response is a *Service Representations List Representation* from the REST management service. The request can return the following status codes:

Results for this resource can be filtered as described in *Filtering Results* on page 1023.

- 200 (OK): the request has been served successfully and the body of the response is a service list representation.
- 400 (BAD REQUEST): the provided filter expression was not valid.
- 406 (NOT ACCEPTABLE): the REST management service does not support any of the requested representations.

**137.3.10****Service Resource**

framework/service/{serviceid}

The service resource represents a single, distinct service in the framework. Hence, it has to be qualified by a service id. Services can only be read through the REST Management Service and therefore only support the GET request.

**137.3.10.1****GET**

The GET request retrieves a *Service Representation*. The request can return the following status codes:

- 200 (OK): the request has been served successfully and the body of the response is a service representation.
- 404 (NOT FOUND): there is not service with the given service id.
- 406 (NOT ACCEPTABLE): the REST management service does not support any of the requested representations.

**137.4 Representations****137.4.1****Bundle Representation****137.4.1.1****JSON**

Content-Type: application/org.osgi.bundle+json

```
{
```

```

    "id":0,
    "lastModified":1314999275542,
    "state":32,
    "symbolicName":"org.eclipse.osgi",
    "version":"3.7.0.v20110613"
  }

```

**137.4.1.2****XML**

Content-Type: application/org.osgi.bundle+xml

```

<bundle>
  <id>0</id>
  <lastModified>1314999275542</lastModified>
  <state>32</state>
  <symbolicName>org.eclipse.osgi</symbolicName>
  <version>3.7.0.v20110613</version>
</bundle>

```

**137.4.2****Bundles Representations****137.4.2.1****Bundle List Representation***137.4.2.1.1**JSON*

Content-Type: application/org.osgi.bundles+json

```

{
  [bundleURI, bundleURI, ..., bundleURI]
}

```

*137.4.2.1.2**XML*

Content-Type: application/org.osgi.bundles+xml

```

<bundles>
  <uri>bundleURI</uri>
  <uri>bundleURI</uri>
  ...
  <uri>bundleURI</uri>
</bundles>

```

**137.4.2.2****Bundle Representations List Representation***137.4.2.2.1**JSON*

Content-Type: application/org.osgi.bundles.representations+json

```

{
  [BUNDLE REPRESENTATION, BUNDLE REPRESENTATION, ..., BUNDLE REPRESENTATION]
}

```

*137.4.2.2.2**XML*

Content-Type: application/org.osgi.bundles.representations+xml

```

<bundles>
  BUNDLE REPRESENTATION
  BUNDLE REPRESENTATION
  ...
  BUNDLE REPRESENTATION

```

```
</bundles>
```

### 137.4.3 Bundle State Representation

#### 137.4.3.1 JSON

Content-Type: application/org.osgi.bundlestate+json

```
{
  "state": 32
  "options": 1
}
```

The options are used in start or stop calls. Valid options include, e.g., Bundle.START\_TRANSIENT and Bundle.START\_ACTIVATION\_POLICY.

#### 137.4.3.2 XML

Content-Type: application/org.osgi.bundlestate+xml

```
<bundleState>
  <state>32</state>
  <options>1</options>
</bundleState>
```

### 137.4.4 Bundle Header Representation

#### 137.4.4.1 JSON

Content-Type: application/org.osgi.bundleheader+json

```
{
  key: value,
  key: value,
  ...
  key: value
}
```

#### 137.4.4.2 XML

Content-Type: application/org.osgi.bundleheader+xml

```
<bundleHeader>
  <entry key="key" value="value" />
  <entry key="key" value="value" />
  ...
  <entry key="key" value="value" />
</bundleHeader>
```

### 137.4.5 Framework Startlevel Representation

#### 137.4.5.1 JSON

Content-Type: application/org.osgi.frameworkstartlevel+json

```
{
  "startLevel": 6,
  "initialBundleStartLevel": 4
}
```

**137.4.5.2****XML**

Content-Type: application/org.osgi.frameworkstartlevel+xml

```
<frameworkStartLevel>
  <startLevel>6</startLevel>
  <initialBundleStartLevel>4</initialBundleStartLevel>
</frameworkStartLevel>
```

**137.4.6****Bundle Startlevel Representation****137.4.6.1****JSON**

Content-Type: application/org.osgi.bundlestartlevel+json

```
{
  "startLevel": 6

  "activationPolicyUsed": true
  "persistentlyStarted": false
}
```

**137.4.6.2****XML**

Content-Type: application/org.osgi.bundlestartlevel+xml

```
<bundleStartLevel>
  <startLevel>6</startLevel>

  <activationPolicyUsed>true</activationPolicyUsed>
  <persistentlyStarted>>false</persistentlyStarted>
</bundleStartLevel>
```

**137.4.7****Service Representation****137.4.7.1****JSON**

Content-Type: application/org.osgi.service+json

```
{
  "id": 10,
  "properties":
  {
    "prop1": "val1",
    "prop2": 2.82,
    ...
    "prop3": true
  },
  "bundle": bundleURI,
  "usingBundles": [bundleURI, bundleURI, ... bundleURI]
}
```

*Note:* service properties are converted to JSON-supported data types where possible: "string", number or boolean (true|false). If there is no conversion to JSON data types is possible the toString() result is used as a string value.

**137.4.7.2****XML**

Content-Type: application/org.osgi.service+xml

```
<service>
```

```

    <id>10</id>
    <properties>
      <property name="prop1" value="val1" />
      <property name="prop2" type="Float" value="2.82" />
      ...
      <property name="prop3" type="Boolean" value="true" />
    </properties>
  <bundle>bundleURI</bundle>
  <usingBundles>
    <bundle>bundleURI</bundle>
    <bundle>bundleURI</bundle>
    ...
    <bundle>bundleURI</bundle>
  </usingBundles>
</service>

```

*Note:* service properties are represented using the same method as used for the property XML element in the Declarative Services specification, see *Property and Properties Elements* on page 309. Service properties that cannot be represented using the supported data types, will be represented as String values obtained via the `toString()` method.

## 137.4.8 Services Representations

### 137.4.8.1 Service List Representation

#### 137.4.8.1.1 JSON

Content-Type: application/org.osgi.services+json

```

{
  [serviceURI, serviceURI, ..., serviceURI]
}

```

#### 137.4.8.1.2 XML

Content-Type: application/org.osgi.services+xml

```

<services>
  <uri>serviceURI</uri>
  <uri>serviceURI</uri>
  ...
  <uri>serviceURI</uri>
</services>

```

### 137.4.8.2 Service Representations List Representation

#### 137.4.8.2.1 JSON

Content-Type: org.osgi.services.representations+json

```

{
  [SERVICE REPRESENTATION, SERVICE REPRESENTATION, ..., SERVICE REPRESENTATION]
}

```

#### 137.4.8.2.2 XML

Content-Type: application/org.osgi.services.representations+xml

```

<services>
  SERVICE REPRESENTATION

```

```

    SERVICE REPRESENTATION
    ...
    SERVICE REPRESENTATION
  </services>

```

## 137.4.9 Bundle Exception Representation

### 137.4.9.1 JSON

Content-Type: application/org.osgi.bundleexception+json

```

{
  "typecode": 5,
  "message": "BundleException: Bundle activation error"
}

```

### 137.4.9.2 XML

Content-Type: application/org.osgi.bundleexception+xml

```

<bundleexception>
  <typecode>5</typecode>
  <message>BundleException: Bundle activation error</message>
</bundleexception>

```

## 137.5 Clients

The REST service can be used by a variety of clients directly. In addition this specification describes Client APIs built over this REST protocol to facilitate use from Java and JavaScript clients.

### 137.5.1 Java Client

The Java Client provides a Java API over the REST API providing a convenient and portable way to use this API from a Java application.

To use the Java Client, obtain the [RestClientFactory](#) service. Create a client by providing the root URL of the REST service, for example:

```

RestClientFactory restClientFactory = ... // from Service Registry
RestClient restClient = restClientFactory.createRestClient(
    new URI("http://localhost:8080/restendpoint"));

// Now we can start interacting
Collection<String> bundles = restClient.getBundlePaths();
BundleDTO newBundle = restClient.installBundle(bundleLocation, bundleStream);
restClient.startBundle(newBundle.id);

```

The more details on the Java Client can be found in the [org.osgi.service.rest.client](#) API documentation section.

### 137.5.2 JavaScript Client

This specification also describes a JavaScript client to the REST Management service. This client makes it easy to manage an OSGi framework from any JavaScript environment, including Web Browsers.

The JavaScript client follows the *promises* programming style; the request is made asynchronously and a success() or failure() callback is made when the response arrives.

To use the JavaScript client create an instance of `OSGiRestClient` providing the root URL of the REST service.

```
var client = new OSGiRestClient('http://localhost:8080/restendpoint');
client.installBundle({
  success : function(res) {
    // Start the bundle once the install has finished
    client.startBundle(res.id);
  },
  failure : function(httpCode, res) {
    // handle failure
  }
});
```

More details on the JavaScript Client can be found in the [JavaScript Client API](#) API documentation section.

## 137.6 Extending the REST Management Service

This specification describes a REST-based management interface for Core Framework functionality. Other services in the framework might also benefit from management access through REST. This can involve services specified by the OSGi Alliance as part of the Core Framework, Compendium, or Enterprise Specifications but also application-specific functionality provided by the developer. It is desirable to expose such management services as extensions of the REST Management Service.

This REST service can be implemented by using various technologies such as Java Servlets, Restlet, JAX-RS, and others. Therefore, it might not always be possible to integrate extensions at the implementation level because they might use other underlying technologies to implement their REST interface. Defining a format for delegating requests between the REST Management Service and extensions would furthermore necessarily expose implementation details and is therefore not feasible either. As a consequence, this specification only describes how to logically integrate extensions with the REST Management Service. Implementations of this specification might offer mechanisms for tighter integration for the case that extensions are developed using the same underlying technology.

The main purpose of the extension mechanism is to advertise extensions to the core REST implementation, which makes them discoverable for clients. This mechanism can be used to check if a REST interface exists for a specific service. This is done through the *Extensions Resource* which contains a description and a path for every extension currently available. Implementations that want to contribute their extensions to the REST Management Service can do so by registering the [RestApiExtension](#) service using the [4] *Whiteboard Pattern*. The extension interface is only a marker and the relevant information is exposed through the `NAME`, `URI_PATH` and optionally `SERVICE` properties. Note that it is the responsibility of the extension to ensure that the endpoint announced via the `RestApiExtension` service is actually present. The *Whiteboard* service does not realize the extension endpoint; it purely announces it to the main REST implementation for inclusion in the *Extensions Resource*.

In order to be discoverable REST interface extensions to OSGi Core, Compendium, or Enterprise services must use their canonical package name as advertised name. E.g., the name of the REST interface for the User Admin must be `org.osgi.service.useradmin`. This way, a client is able to check if there is a given extension available on a host. User-defined extensions should use the package name of the service they provide management capabilities for.

### 137.6.1 Extensions Resource

extensions

The extensions resource enumerates all extensions currently registered through the Whiteboard Pattern. It is read-only and therefore only supports the GET request.

### 137.6.1.1 GET

The GET request retrieves a *Extensions Representation*. The request can return the following status codes:

- 200 (OK): the request has been served successfully and the body of the response is a extension list representation.
- 406 (NOT ACCEPTABLE): the REST management service does not support any of the requested representations.

## 137.6.2 Extensions Representation

### 137.6.2.1 JSON

Content-Type: application/org.osgi.extensions+json

```
{
  [ { "name" : "org.osgi.service.event", "path" : "contributions/eventadmin",
      "service" : 12 }, ... ]
}
```

### 137.6.2.2 XML

Content-Type: application/org.osgi.extensions+xml

```
<extensions>
  <extension>
    <name>org.osgi.service.event</name>
    <path>contributions/eventadmin</path>
    <service>12</service>
  </extension>
</extensions>
```

## 137.7 XML Schema

The namespace for XML representations is:

<http://www.osgi.org/xmlns/rest/v1.0.0>

The recommended prefix for this namespace is rest.

```
<schema xmlns="http://www.w3.org/2001/XMLSchema"
  xmlns:rest="http://www.osgi.org/xmlns/rest/v1.0.0"
  targetNamespace="http://www.osgi.org/xmlns/rest/v1.0.0"
  elementFormDefault="unqualified"
  attributeFormDefault="unqualified"
  version="1.0.0">

  <annotation>
    <documentation xml:lang="en">
      This is the XML Schema for
      XML representations used by
      the REST Management Service
      Specification.
    </documentation>
  </annotation>

  <element name="bundle" type="rest:Tbundle">
    <annotation>
      <documentation xml:lang="en">
```



```

        Representation for the
        application/org.osgi.bundle+xml content type.
    </documentation>
</annotation>
</element>
<complexType name="Tbundle">
    <all>
        <element name="id" type="long" />
        <element name="lastModified" type="long" />
        <element name="state" type="integer" />
        <element name="symbolicName" type="string" />
        <element name="version" type="string" />
    </all>
</complexType>

<element name="bundles" type="rest:Tbundles">
    <annotation>
        <documentation xml:lang="en">
            Representation for the
            application/org.osgi.bundles+xml and
            application/org.osgi.bundles.representations+xml content
            types.
        </documentation>
    </annotation>
</element>
<complexType name="Tbundles">
    <choice>
        <element name="uri" type="string" minOccurs="0"
            maxOccurs="unbounded">
            <annotation>
                <documentation xml:lang="en">
                    Representation for the
                    application/org.osgi.bundles+xml content type.
                </documentation>
            </annotation>
        </element>
        <element name="bundle" type="rest:Tbundle"
            minOccurs="0" maxOccurs="unbounded">
            <annotation>
                <documentation xml:lang="en">
                    Representation for the
                    application/org.osgi.bundles.representations+xml
                    content type.
                </documentation>
            </annotation>
        </element>
    </choice>
</complexType>

<element name="bundleState" type="rest:TbundleState">
    <annotation>
        <documentation xml:lang="en">
            Representation for the
            application/org.osgi.bundlestate+xml content type.
        </documentation>
    </annotation>
</element>
<complexType name="TbundleState">
    <all>
        <element name="state" type="integer" />
        <element name="options" type="integer" />
    </all>
</complexType>

<element name="bundleHeader" type="rest:TbundleHeader">
    <annotation>
        <documentation xml:lang="en">
            Representation for the
            application/org.osgi.bundleheader+xml content type.
        </documentation>
    </annotation>
</element>
<complexType name="TbundleHeader">
    <sequence>
        <element name="entry" minOccurs="0" maxOccurs="unbounded">

```

```

        <complexType>
          <attribute name="key" type="string" use="required" />
          <attribute name="value" type="string" use="required" />
        </complexType>
      </element>
    </sequence>
  </complexType>

  <element name="frameworkStartLevel" type="rest:TframeworkStartLevel">
    <annotation>
      <documentation xml:lang="en">
        Representation for the
        application/org.osgi.frameworkstartlevel+xml content
        type.
      </documentation>
    </annotation>
  </element>
  <complexType name="TframeworkStartLevel">
    <all>
      <element name="startLevel" type="integer" />
      <element name="initialBundleStartLevel" type="integer" />
    </all>
  </complexType>

  <element name="bundleStartLevel" type="rest:TbundleStartLevel">
    <annotation>
      <documentation xml:lang="en">
        Representation for the
        application/org.osgi.bundlestartlevel+xml content type.
      </documentation>
    </annotation>
  </element>
  <complexType name="TbundleStartLevel">
    <all>
      <element name="startLevel" type="integer" />
      <element name="activationPolicyUsed" type="boolean" />
      <element name="persistentlyStarted" type="boolean" />
    </all>
  </complexType>

  <element name="service" type="rest:Tservice">
    <annotation>
      <documentation xml:lang="en">
        Representation for the
        application/org.osgi.service+xml content type.
      </documentation>
    </annotation>
  </element>
  <complexType name="Tservice">
    <all>
      <element name="id" type="long" />
      <element name="properties">
        <complexType>
          <sequence>
            <element name="property" minOccurs="0"
              maxOccurs="unbounded">
              <complexType>
                <simpleContent>
                  <extension base="string">
                    <attribute name="name"
                      type="string" use="required" />
                    <attribute name="value"
                      type="string" use="optional" />
                    <attribute name="type"
                      default="String" use="optional">
                      <simpleType>
                        <restriction
                          base="string">
                          <enumeration
                            value="String" />
                          <enumeration
                            value="Long" />
                          <enumeration
                            value="Double" />
                          <enumeration

```

```

        value="Float" />
        <enumeration
            value="Integer" />
        <enumeration
            value="Byte" />
        <enumeration
            value="Character" />
        <enumeration
            value="Boolean" />
        <enumeration
            value="Short" />
    </restriction>
</simpleType>
</attribute>
</extension>
</simpleContent>
</complexType>
</element>
</sequence>
</complexType>
</element>
<element name="bundle" type="string" />
<element name="usingBundles">
    <complexType>
        <sequence>
            <element name="bundle" type="string"
                minOccurs="0" maxOccurs="unbounded" />
        </sequence>
    </complexType>
</element>
</all>
</complexType>

<element name="services" type="rest:Tservices">
    <annotation>
        <documentation xml:lang="en">
            Representation for the
            application/org.osgi.services+xml and
            application/org.osgi.services.representations+xml
            content types.
        </documentation>
    </annotation>
</element>
<complexType name="Tservices">
    <choice>
        <element name="uri" type="string" minOccurs="0"
            maxOccurs="unbounded">
            <annotation>
                <documentation xml:lang="en">
                    Representation for the
                    application/org.osgi.services+xml content type.
                </documentation>
            </annotation>
        </element>
        <element name="service" type="rest:Tservice"
            minOccurs="0" maxOccurs="unbounded">
            <annotation>
                <documentation xml:lang="en">
                    Representation for the
                    application/org.osgi.services.representations+xml
                    content type.
                </documentation>
            </annotation>
        </element>
    </choice>
</complexType>

<element name="bundleexception" type="rest:Tbundleexception">
    <annotation>
        <documentation xml:lang="en">
            Representation for the
            application/org.osgi.bundleexception+xml content type.
        </documentation>
    </annotation>
</element>

```

```

<complexType name="Tbundleexception">
  <all>
    <element name="typecode" type="integer" />
    <element name="message" type="string" />
  </all>
</complexType>

<element name="extensions" type="rest:Textensions">
  <annotation>
    <documentation xml:lang="en">
      Representation for the
      application/org.osgi.extensions+xml content type.
    </documentation>
  </annotation>
</element>
<complexType name="Textensions">
  <sequence>
    <element name="extension" minOccurs="0" maxOccurs="unbounded">
      <complexType>
        <all>
          <element name="name" type="string" />
          <element name="path" type="string" />
          <element name="service" type="long" minOccurs="0" />
        </all>
      </complexType>
    </element>
  </sequence>
</complexType>
</schema>

```

The schema is also available in digital form from [3] *OSGi XML Schemas*.

## 137.8 Capabilities

### 137.8.1 osgi.implementation Capability

An implementation of this specification must provide the `osgi.implementation` capability with name `osgi.rest`. This capability can be used by provisioning tools and during resolution to ensure that a REST Management implementation is present to handle REST requests defined in this specification. The capability must also declare a uses constraint on the `org.osgi.service.rest` package:

```

Provide-Capability: osgi.implementation;
  osgi.implementation="osgi.rest";
  uses:="org.osgi.service.rest";
  version:Version="1.0"

```

This capability must follow the rules defined for the *osgi.implementation Namespace* on page 997.

### 137.8.2 osgi.service Capability

A bundle providing the `RestClientFactory` service as described by this specification must inform tools about this service by providing the `osgi.service` capability representing this service. This capability must also declare a uses constraint for the `org.osgi.service.rest.client` package:

```

Provide-Capability: osgi.service;
  objectClass:List<String>="org.osgi.service.rest.client.RestClientFactory";
  uses:="org.osgi.service.rest.client"

```

This capability must follow the rules defined for the *osgi.service Namespace* on page 997.

## 137.9 Security

Like any externally visible management interface, the REST interface exposes privileged operations and hence requires access control. Since REST builds upon the HTTP(s) protocol, authentication mechanisms and encryption can be applied the same way as usually done for web servers: they can be layered below the REST protocol. E.g., confidentiality of the transmitted commands can be ensured by using HTTPS as the underlying transport. Authentication can be added by requiring, e.g., basic authentication prior to accepting a REST command. The REST interface should only be implemented by a trusted bundle. Implementations of this specification require all Admin Permissions and all Service Permissions.

## 137.10 org.osgi.service.rest

Rest Service Package Version 1.0.

### 137.10.1 Summary

- RestApiExtension - Marker interface for registering extensions to the Rest API service.

### 137.10.2 public interface RestApiExtension

Marker interface for registering extensions to the Rest API service.

The REST service provides a RESTful interface to clients that need to manage an OSGi framework through a network connection. Other components running on the same framework can contribute their own specific REST interface and make it available and discoverable by registering this marker service using the Whiteboard pattern.

Integration of third-party REST interfaces with the framework REST service on the implementation level might not always be possible since it requires knowledge about the underlying implementation and an extension mechanism on that level. Specific technologies such as servlets might support this but the REST service could as well be implemented without the use of a supporting abstraction layer and not offer extensibility.

Using this marker service, the REST service includes the advertised service in the Extensions Resource, allowing clients to discover it and use the extension's functionality.

#### 137.10.2.1 public static final String NAME = "org.osgi.rest.name"

This service property describes the package name of the technology manageable by this REST API extension. Services specified in OSGi specifications must use their canonical package name as the name. Third-party technologies should also use their package names. The type of this property is `java.lang.String` and the property is mandatory.

#### 137.10.2.2 public static final String SERVICE = "org.osgi.rest.service"

This service property refers to the id of the service the REST API extension provides management capabilities for. This can be useful if more than one service of a given type is present in the framework. For example if more than one `Http Service` is available this property is used to associate a REST extension managing the `Http Service` with a specific service instance. The type of the property is `java.lang.Long` and the property is optional; if the REST extension is not directly associated with a service in the service registry, the property should not be set.

#### 137.10.2.3 public static final String URI\_PATH = "org.osgi.rest.uri.path"

This service property describes a URI to the REST extension on this local machine. It is either a fully qualified URI with a different port if no integration with the framework REST service is possible

or a relative URI implicitly using the same port if integration is possible. The type of this property is `java.lang.String` and the property is mandatory.

## 137.11 org.osgi.service.rest.client

Rest Service Client Package Version 1.0.

### 137.11.1 Summary

- `RestClient` - A Java client API for a REST service endpoint.
- `RestClientFactory` - Factory to construct new REST client instances.

### 137.11.2 public interface `RestClient`

A Java client API for a REST service endpoint.

Provides a Java client API for accessing and managing a remote OSGi framework through the REST API. Implementations of this interface will usually take the URL to the remote REST Management Service instance as an argument in their constructor. Further arguments might be needed, for example, if the cloud provider requires URL signing.

*Provider Type* Consumers of this API must not implement this type

#### 137.11.2.1 public `BundleDTO` `getBundle(long id)` throws `Exception`

*id* Addresses the bundle by its identifier.

- Retrieve the bundle representation for a given bundle Id.

*Returns* A `BundleDTO` for the requested bundle.

*Throws* `Exception`— An exception representing a failure in the underlying REST call.

#### 137.11.2.2 public `BundleDTO` `getBundle(String bundlePath)` throws `Exception`

*bundlePath* Addresses the bundle by its URI path.

- Retrieve the bundle representation for a given bundle path.

*Returns* A `BundleDTO` for the requested bundle.

*Throws* `Exception`— An exception representing a failure in the underlying REST call.

#### 137.11.2.3 public `Map<String,String>` `getBundleHeaders(long id)` throws `Exception`

*id* Addresses the bundle by its identifier.

- Get the header for a bundle given by its bundle Id.

*Returns* Returns the map of headers entries.

*Throws* `Exception`— An exception representing a failure in the underlying REST call.

#### 137.11.2.4 public `Map<String,String>` `getBundleHeaders(String bundlePath)` throws `Exception`

*bundlePath* Addresses the bundle by its URI path.

- Get the header for a bundle given by its URI path.

*Returns* Returns the map of headers entries.

*Throws* `Exception`— An exception representing a failure in the underlying REST call.

#### 137.11.2.5 public `Collection<String>` `getBundlePaths()` throws `Exception`

- Get the bundles currently installed on the managed framework.

*Returns* Returns a collection of the bundle URIs in the form of Strings. The URIs are relative to the REST API root URL and can be used to retrieve bundle representations.

*Throws* Exception— An exception representing a failure in the underlying REST call.

**137.11.2.6      public Collection<BundleDTO> getBundles() throws Exception**

- Get the bundle representations for all bundles currently installed in the managed framework.

*Returns* Returns a collection of BundleDTO objects.

*Throws* Exception— An exception representing a failure in the underlying REST call.

**137.11.2.7      public BundleStartLevelDTO getBundleStartLevel(long id) throws Exception**

*id* Addresses the bundle by its identifier.

- Get the start level for a bundle given by its bundle Id.

*Returns* Returns a BundleStartLevelDTO describing the current start level of the bundle.

*Throws* Exception— An exception representing a failure in the underlying REST call.

**137.11.2.8      public BundleStartLevelDTO getBundleStartLevel(String bundlePath) throws Exception**

*bundlePath* Addresses the bundle by its URI path.

- Get the start level for a bundle given by its URI path.

*Returns* Returns a BundleStartLevelDTO describing the current start level of the bundle.

*Throws* Exception— An exception representing a failure in the underlying REST call.

**137.11.2.9      public int getBundleState(long id) throws Exception**

*id* Addresses the bundle by its identifier.

- Get the state for a given bundle Id.

*Returns* Returns the current bundle state as defined in ([@link org.osgi.framework.Bundle](#)).

*Throws* Exception— An exception representing a failure in the underlying REST call.

**137.11.2.10     public int getBundleState(String bundlePath) throws Exception**

*bundlePath* Addresses the bundle by its URI path.

- Get the state for a given bundle path.

*Returns* Returns the current bundle state as defined in ([@link org.osgi.framework.Bundle](#)).

*Throws* Exception— An exception representing a failure in the underlying REST call.

**137.11.2.11     public FrameworkStartLevelDTO getFrameworkStartLevel() throws Exception**

- Retrieves the current framework start level.

*Returns* Returns the current framework start level in the form of a FrameworkStartLevelDTO.

*Throws* Exception— An exception representing a failure in the underlying REST call.

**137.11.2.12     public Collection<String> getServicePaths() throws Exception**

- Gets a collection of URI paths to all installed services.

*Returns* Returns a collection of URI paths to the installed services.

*Throws* Exception— An exception representing a failure in the underlying REST call.

**137.11.2.13     public Collection<String> getServicePaths(String filter) throws Exception**

*filter* Passes a filter to restrict the result set.

- Gets a collection of URI paths to all installed services.

*Returns* Returns a collection of URI paths to the installed services.

*Throws* Exception— An exception representing a failure in the underlying REST call.

**137.11.2.14 public ServiceReferenceDTO getServiceReference(long id) throws Exception**

*id* Addresses the service by its identifier.

- Get the service representation for a service given by its service Id.

*Returns* The service representation as ServiceReferenceDTO.

*Throws* Exception— An exception representing a failure in the underlying REST call.

**137.11.2.15 public ServiceReferenceDTO getServiceReference(String servicePath) throws Exception**

*servicePath* Addresses the service by its URI path.

- Get the service representation for a service given by its URI path.

*Returns* The service representation as ServiceReferenceDTO.

*Throws* Exception— An exception representing a failure in the underlying REST call.

**137.11.2.16 public Collection<ServiceReferenceDTO> getServiceReferences() throws Exception**

- Get the service representations for all services.

*Returns* Returns the service representations in the form of ServiceReferenceDTO objects.

*Throws* Exception— An exception representing a failure in the underlying REST call.

**137.11.2.17 public Collection<ServiceReferenceDTO> getServiceReferences(String filter) throws Exception**

*filter* Passes a filter to restrict the result set.

- Get the service representations for all services.

*Returns* Returns the service representations in the form of ServiceReferenceDTO objects.

*Throws* Exception— An exception representing a failure in the underlying REST call.

**137.11.2.18 public BundleDTO installBundle(String location) throws Exception**

*location* Passes the location string to retrieve the bundle content from.

- Install a new bundle given by an externally reachable location string, typically describing a URL.

*Returns* Returns the BundleDTO of the newly installed bundle.

*Throws* Exception— An exception representing a failure in the underlying REST call.

**137.11.2.19 public BundleDTO installBundle(String location,InputStream in) throws Exception**

*location* Passes the location string to be used to install the new bundle.

*in* Passes the input stream to a bundle.

- Install a new bundle given by an InputStream to a bundle content.

*Returns* Returns the BundleDTO of the newly installed bundle.

*Throws* Exception— An exception representing a failure in the underlying REST call.

**137.11.2.20 public void setBundleStartLevel(long id,int startLevel) throws Exception**

*id* Addresses the bundle by its identifier.

*startLevel* The target start level.



- Set the start level for a bundle given by its bundle Id.

*Throws* Exception– An exception representing a failure in the underlying REST call.

**137.11.2.21      public void setBundleStartLevel(String bundlePath,int startLevel) throws Exception**

*bundlePath* Addresses the bundle by its URI path.

*startLevel* The target start level.

*Throws* Exception– An exception representing a failure in the underlying REST call.

**137.11.2.22      public void setFrameworkStartLevel(FrameworkStartLevelDTO startLevel) throws Exception**

*startLevel* set the framework start level to this target.

- Sets the current framework start level.

*Throws* Exception– An exception representing a failure in the underlying REST call.

**137.11.2.23      public void startBundle(long id) throws Exception**

*id* Addresses the bundle by its identifier.

- Start a bundle given by its bundle Id.

*Throws* Exception– An exception representing a failure in the underlying REST call.

**137.11.2.24      public void startBundle(String bundlePath) throws Exception**

*bundlePath* Addresses the bundle by its URI path.

- Start a bundle given by its URI path.

*Throws* Exception– An exception representing a failure in the underlying REST call.

**137.11.2.25      public void startBundle(long id,int options) throws Exception**

*id* Addresses the bundle by its identifier.

*options* Passes additional options as defined in org.osgi.framework.Bundle.start(int)

- Start a bundle given by its bundle Id.

*Throws* Exception– An exception representing a failure in the underlying REST call.

**137.11.2.26      public void startBundle(String bundlePath,int options) throws Exception**

*bundlePath* Addresses the bundle by its URI path.

*options* Passes additional options as defined in org.osgi.framework.Bundle.start(int)

- Start a bundle given by its URI path.

*Throws* Exception– An exception representing a failure in the underlying REST call.

**137.11.2.27      public void stopBundle(long id) throws Exception**

*id* Addresses the bundle by its identifier.

- Stop a bundle given by its bundle Id.

*Throws* Exception– An exception representing a failure in the underlying REST call.

**137.11.2.28      public void stopBundle(String bundlePath) throws Exception**

*bundlePath* Addresses the bundle by its URI path.

- Stop a bundle given by its URI path.

*Throws* Exception– An exception representing a failure in the underlying REST call.

- 137.11.2.29**      **public void stopBundle(long id,int options) throws Exception**  
*id* Addresses the bundle by its identifier.  
*options* Passes additional options as defined in org.osgi.framework.Bundle.stop(int)  
□ Stop a bundle given by its bundle Id.  
*Throws* Exception– An exception representing a failure in the underlying REST call.
- 137.11.2.30**      **public void stopBundle(String bundlePath,int options) throws Exception**  
*bundlePath* Addresses the bundle by its URI path.  
*options* Passes additional options as defined in org.osgi.framework.Bundle.stop(int)  
□ Stop a bundle given by its URI path.  
*Throws* Exception– An exception representing a failure in the underlying REST call.
- 137.11.2.31**      **public BundleDTO uninstallBundle(long id) throws Exception**  
*id* Addresses the bundle by its identifier.  
□ Uninstall a bundle given by its bundle Id.  
*Returns* Returns the BundleDTO of the uninstalled bundle.  
*Throws* Exception– An exception representing a failure in the underlying REST call.
- 137.11.2.32**      **public BundleDTO uninstallBundle(String bundlePath) throws Exception**  
*bundlePath* Addresses the bundle by its URI path.  
□ Uninstall a bundle given by its URI path.  
*Returns* Returns the BundleDTO of the uninstalled bundle.  
*Throws* Exception– An exception representing a failure in the underlying REST call.
- 137.11.2.33**      **public BundleDTO updateBundle(long id) throws Exception**  
*id* Addresses the bundle by its identifier.  
□ Updates a bundle given by its bundle Id using the bundle-internal update location.  
*Returns* Returns the BundleDTO of the updated bundle.  
*Throws* Exception– An exception representing a failure in the underlying REST call.
- 137.11.2.34**      **public BundleDTO updateBundle(long id,String url) throws Exception**  
*id* Addresses the bundle by its identifier.  
*url* The URL whose content is to be used to update the bundle.  
□ Updates a bundle given by its URI path using the content at the specified URL.  
*Returns* Returns the BundleDTO of the updated bundle.  
*Throws* Exception– An exception representing a failure in the underlying REST call.
- 137.11.2.35**      **public BundleDTO updateBundle(long id,InputStream in) throws Exception**  
*id* Addresses the bundle by its identifier.  
*in* Passes an input stream to the new bundle content.  
□ Updates a bundle given by its bundle Id and passing the new bundle content in the form of an InputStream.  
*Returns* Returns the BundleDTO of the updated bundle.

*Throws* Exception— An exception representing a failure in the underlying REST call.

### 137.11.3 **public interface RestClientFactory**

Factory to construct new REST client instances. Each instance is specific to a REST service endpoint.

Implementations can choose to extend this interface to add additional creation methods, where additional arguments are needed for request signing, etc.

In OSGi environments, this factory is registered as a service.

*Provider Type* Consumers of this API must not implement this type

#### 137.11.3.1 **public RestClient createRestClient(URI uri)**

*uri* The URI to the REST service endpoint.

- Create a new REST client instance.

*Returns* A new REST client instance for the specified REST service endpoint.

## 137.12 **JavaScript Client API**

REST JavaScript Client API Version 1.0

### 137.12.1 **Summary**

- `OSGiRestClient` - A JavaScript client API for accessing and managing a remote OSGi framework through the REST API.
- `OSGiRestCallback` - Callback object provided to the `OSGiRestClient` functions. Invoked on completion of the remote invocation.

JavaScript does not support the concept of interfaces and therefore implementations of the JavaScript client specification can provide objects of any type as long as they conform to the to the signatures described in this specification.

To facilitate documenting the JavaScript APIs *Web IDL* is used; see [2] *Web IDL*. This clarifies the accepted arguments and return types for otherwise untyped functions. Web IDL is only used for documentation purposes and has no bearing on the implementation of this API.

*Note:* some data types in Web IDL have slightly different names than commonly used in languages like Java or JavaScript. For example a String is called `DOMString` and the equivalent of a Java long is called `long long`. Additionally, when a representation as defined in this specification is passed to one of the JavaScript client APIs this representation is provided as a JavaScript object. Following the recommendations for mapping these to Web IDL, these JavaScript Object parameters are described using the dictionary data type. For more information see the Web IDL specification.

### 137.12.2 **interface OSGiRestClient**

Provides a JavaScript client API for accessing and managing a remote OSGi framework through the REST API. Implementations will provide a proprietary constructor to create objects of this signature. Once created the object can be used from JavaScript environments to manage the framework.

#### 137.12.2.1 **void getBundle((DOMString or long long) bundle, OSGiRestCallback cb)**

*bundle* The bundle, either the numeric bundle ID or the bundle URI path.

*cb* The callbacks invoked on completion of the remote invocation. On success the `success()` callback is invoked with the Bundle representation as JavaScript object.

- Get the Bundle representation of a specific bundle.

**137.12.2.2 void getBundleHeader((DOMString or long long) bundle, OSGiRestCallback cb)**

*bundle* The bundle, either the numeric bundle ID or the bundle URI path.

*cb* The callbacks invoked on completion of the remote invocation. On success the success() callback is invoked with the Bundle Header representation as JavaScript object.

- Get the Bundle Header representation of a specific bundle.

**137.12.2.3 void getBundleRepresentations(OSGiRestCallback cb)**

*cb* The callbacks invoked on completion of the remote invocation. On success the success() callback is invoked with the Bundle Representations List representation as JavaScript object.

- List the bundles details.

**137.12.2.4 void getBundles(OSGiRestCallback cb)**

*cb* The callbacks invoked on completion of the remote invocation. On success the success() callback is invoked with the Bundle List representation as JavaScript object.

- List the bundles.

**137.12.2.5 void getBundleStartLevel((DOMString or long long) bundle, OSGiRestCallback cb)**

*bundle* The bundle, either the numeric bundle ID or the bundle URI path.

*cb* The callbacks invoked on completion of the remote invocation. On success the success() callback is invoked with the Bundle Start Level representation as JavaScript object.

- Get the Bundle Start Level representation of a specific bundle.

**137.12.2.6 void getBundleState((DOMString or long long) bundle, OSGiRestCallback cb)**

*bundle* The bundle, either the numeric bundle ID or the bundle URI path.

*cb* The callbacks invoked on completion of the remote invocation. On success the success() callback is invoked with the Bundle State representation as JavaScript object.

- Get the Bundle State representation of a specific bundle.

**137.12.2.7 void getFrameworkStartLevel(OSGiRestCallback cb)**

*cb* The callbacks invoked on completion of the remote invocation. On success the success() callback is invoked with the Framework Start Level representation as JavaScript object.

- Obtain the Framework Start Level.

**137.12.2.8 void getService((DOMString or long long) service, OSGiRestCallback cb)**

*service* The service, either the numeric service ID or the service URI path.

*cb* The callbacks invoked on completion of the remote invocation. On success the success() callback is invoked with the Service representation as JavaScript object.

- Get a service representation.

**137.12.2.9 void getServiceRepresentations(OSGiRestCallback cb)**

*cb* The callbacks invoked on completion of the remote invocation. On success the success() callback is invoked with the Service Representations List representation as JavaScript object.

- Get all services representations.

**137.12.2.10 void getServices(OSGiRestCallback cb)**

*cb* The callbacks invoked on completion of the remote invocation. On success the success() callback is invoked with the Service List representation as JavaScript object.

- Get all services URIs.

**137.12.2.11 void installBundle((DOMString or ArrayBuffer) bundle, OSGiRestCallback cb)**

*bundle* The Bundle to install, either represented as a URL or as an ArrayBuffer of

*cb* The callbacks invoked on completion of the remote invocation. On success the success() callback is invoked with the Bundle representation of the newly installed Bundle. This parameter is optional.

- Install a bundle from a URI or by value.

**137.12.2.12 void setBundleStartLevel((DOMString or long long) bundle, dictionary bsL, OSGiRestCallback cb)**

*bundle* The bundle, either the numeric bundle ID or the bundle URI path.

*bsL* A Bundle Start Level representation dictionary with the desired state.

*cb* The callbacks invoked on completion of the remote invocation. On success the success() callback is invoked with the resulting Framework Start Level representation as JavaScript object. This parameter is optional.

- Change the Framework Start Level and/or initial bundle start level.

**137.12.2.13 void setBundleState((DOMString or long long) bundle, dictionary state, OSGiRestCallback cb)**

*bundle* The bundle, either the numeric bundle ID or the bundle URI path.

*state* Bundle State representation dictionary with the desired state.

*cb* The callbacks invoked on completion of the remote invocation. On success the success() callback is invoked with the resulting Bundle Start Level representation as JavaScript object. This parameter is optional.

- Change the Bundle Start Level and/or other options defined in the Bundle Start Level representation.

**137.12.2.14 void setFrameworkStartLevel(dictionary fwsL, OSGiRestCallback cb)**

*fwsL* Framework Start Level representation dictionary with the desired state.

*cb* The callbacks invoked on completion of the remote invocation. On success the success() callback is invoked with the resulting Framework Start Level representation as JavaScript object. This parameter is optional.

- Change the Framework Start Level and/or initial bundle start level.

**137.12.2.15 void startBundle((DOMString or long long) bundle, OSGiRestCallback cb)**

*bundle* The bundle, either the numeric bundle ID or the bundle URI path.

*cb* The callbacks invoked on completion of the remote invocation. On success the success() callback is invoked with the Bundle State representation as JavaScript object. This parameter is optional.

- Start a bundle.

**137.12.2.16 void startBundle((DOMString or long long) bundle, long options, OSGiRestCallback cb)**

*bundle* The bundle, either the numeric bundle ID or the bundle URI path.

*options* The options passed to the bundle's start method as a number.

*cb* The callbacks invoked on completion of the remote invocation. On success the success() callback is invoked with the Bundle State representation as JavaScript object. This parameter is optional.

- Start a bundle.

**137.12.2.17 void stopBundle((DOMString or long long) bundle, OSGiRestCallback cb)**

*bundle* The bundle, either the numeric bundle ID or the bundle URI path.

- cb* The callbacks invoked on completion of the remote invocation. On success the `success()` callback is invoked with the Bundle State representation as JavaScript object. This parameter is optional.
- Stop a bundle.

### 137.12.2.18 **void stopBundle((DOMString or long long) bundle, long options, OSGiRestCallback cb)**

*bundle* The bundle, either the numeric bundle ID or the bundle URI path.

*options* The options passed to the bundle's start method as a number.

- cb* The callbacks invoked on completion of the remote invocation. On success the `success()` callback is invoked with the Bundle State representation as JavaScript object. This parameter is optional.
- Stop a bundle.

### 137.12.2.19 **void uninstallBundle((DOMString or long long) bundle, OSGiRestCallback cb)**

*bundle* The bundle, either the numeric bundle ID or the bundle URI path.

- cb* The callbacks invoked on completion of the remote invocation. On success the `success()` callback is invoked with the Bundle representation of the uninstalled Bundle. This parameter is optional.

- Uninstall a bundle.

### 137.12.2.20 **void updateBundle((DOMString or long long) bundle, (DOMString or ArrayBuffer) updated, OSGiRestCallback cb)**

*bundle* The bundle, either the numeric bundle ID or the bundle URI path.

*updated* The Bundle to update, either represented as a URL or as an ArrayBuffer of

- cb* The callbacks invoked on completion of the remote invocation. On success the `success()` callback is invoked with the Bundle representation of the updated Bundle. This parameter is optional.

- Update a bundle from a URI or by value.

## 137.12.3 **callback interface OSGiRestCallback**

Objects implementing this signature are provided by users of the `OSGiRestClient` as callbacks. One of the callback functions is invoked on completion of a REST invocation.

### 137.12.3.1 **void success(object response)**

*response* The result of the invocation. The type of this parameter is depends on the function being invoked. It can be found in the documentation of the function.

- Called when the invocation completes successfully.

### 137.12.3.2 **void failure(short httpCode, object response)**

*httpCode* The HTTP code returned. If no HTTP code is associated with the failure this parameter is set to -1.

*response* The failure response.

- Called when the invocation failed.

## 137.13 **References**

- [1] *Framework Filter Syntax*  
OSGi Core, Chapter 3.2.7 Filter Syntax
- [2] *Web IDL*  
<http://www.w3.org/TR/WebIDL/>

- [3] *OSGi XML Schemas*  
<http://www.osgi.org/Specifications>
- [4] *Whiteboard Pattern*  
<http://www.osgi.org/wiki/uploads/Links/whiteboard.pdf>





# 138 Asynchronous Service Specification

*Version 1.0*

## 138.1 Introduction

OSGi Bundles collaborate using loosely coupled services registered in the OSGi service registry. This is a powerful and flexible model, and allows for the dynamic replacement of services at runtime. OSGi services are therefore a very common interaction pattern within OSGi.

As with most Java APIs and Objects, OSGi services are primarily synchronous in operation. This has several benefits; synchronous APIs are typically easier to write and to use than asynchronous ones; synchronous APIs provide immediate feedback; synchronous implementations typically have a less complex threading model.

Asynchronous APIs, however, have different advantages. Asynchronous APIs can reduce bottlenecks by encouraging more effective use of parallelism, improving the responsiveness of the application. In many cases high throughput systems can be written more simply and elegantly using asynchronous programming techniques.

The *Promises Specification* on page 1137 provides powerful primitives for asynchronous programming, including the ability to compose flows in a functional style. There are, however, many existing services that do not use the Promise API. The purpose of the Asynchronous Service is to bridge the gap between these existing, primarily synchronous, services in the OSGi service registry, and asynchronous programming. The Asynchronous Service therefore provides a way to invoke arbitrary OSGi services asynchronously, providing results and failure notifications through the Promise API.

### 138.1.1 Essentials

- *Async Invocation* - A single method call that is to be executed without blocking the requesting thread.
- *Client* - Application code that wishes to invoke one or more OSGi services asynchronously.
- *Async Service* - The OSGi service representing the Asynchronous Services implementation. Used by the Client to make one or more Async Invocations.
- *Async Mediator* - A mediator object created by the Async Service which represents the target service. Used by the Client to register Async Invocations.
- *Success Callback* - A callback made when an Async Invocation completes with a normal return value.
- *Failure Callback* - A callback made when an Async Invocation completes with an exception.

### 138.1.2 Entities

- *Async Service* - A service that can create Async Mediators and run Async Invocations.
- *Target Service* - A service that is to be called asynchronously by the Client.
- *Client* - The code that makes Async Invocations using the Async Service

- *Promise* - A promise, representing the result of the Async Invocation.

Figure 138.1

Class and Service overview

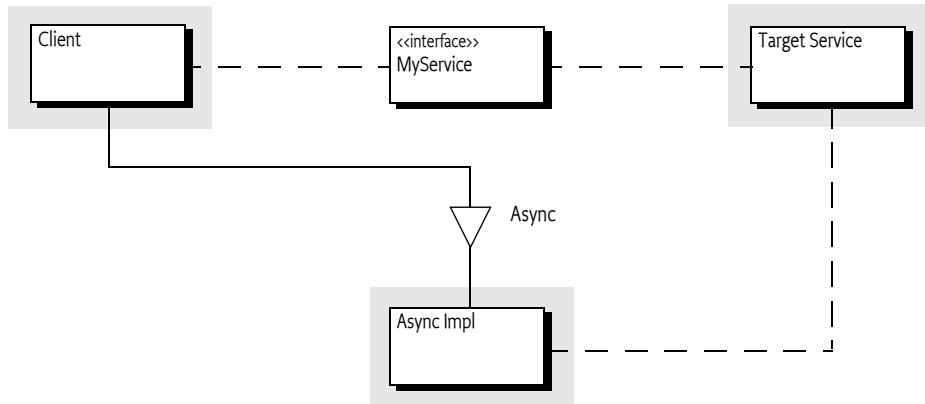

## 138.2 Usage

This section is an introduction in the usage of the Async Service. It is not the formal specification, the normative part starts at *Async Service* on page 1057. This section leaves out some of the details for clarity.

### 138.2.1 Synopsis

The Async Service provides a mechanism for a client to *asynchronously* invoke methods on a target service. The service may be aware of the asynchronous nature of the call and actively participate in it, or be unaware and execute normally. In either case the client's thread will not block, and will continue executing its next instructions. Clients are notified of the completion of their task, and whether it was successful or not, through the use of the Promise API.

Each async invocation is registered by the client making a method call on an *Async Mediator*, and then started by making a call to the Async Service that created the mediator. This call returns a Promise that will eventually be resolved with the return value from the async invocation.

An Async Mediator can be created by the client, either from an Object, or directly from a Service Reference. Using a service reference has the advantage that the mediator will track the underlying service. This means that if the service is unregistered before the asynchronous call begins then the Promise will resolve with a failure, rather than continuing using an invalid service object.

### 138.2.2 Making Async Invocations

The general pattern for a client is to obtain the Async Service, and a service reference for the target service. The client then creates an Async Mediator for the target service, invokes a method on the mediator, then starts the asynchronous call. This is demonstrated in the following example:

```

private Async asyncService;
private ServiceReference<Foo> fooRef;
private Foo mediated;

@Reference
void setAsync(Async async) {

```

```

    asyncService = async;
}

@Reference(service = Foo.class)
void setList(ServiceReference<Foo> foo) {
    fooRef = foo;
}

@Activate
void start() {
    mediated = asyncService.mediate(fooRef, Foo.class);
}

public synchronized void doStuff() {
    Promise<Boolean> promise = asyncService
        .call(mediated.booleanMethod("aValue"));
    ...
}

```

This example demonstrates how simply clients can make asynchronous calls using the Async Service. The eventual result can be obtained from the promise using one of the relevant callbacks.

One important thing to note is that whilst the call to `call()` or `call(R)` causes the async invocation to begin, the actual execution of the underlying task may be queued until a thread is available to run it. If the service has been unregistered before the execution actually begins then the promise will be resolved with a Service Exception. The type of the Service Exception will be `ASYNC_ERROR`.

### 138.2.3 Async Invocations of Void Methods

The return value of the mediator method call is used to provide type information to the Async Service. This, however, does not work for void methods that have no return value. In this case the client can either pass an arbitrary object to the `call(R)` method, or use the zero argument `call()` method. In either case the returned promise will eventually resolve with a value of null. This is demonstrated in the following example.

```

private Async asyncService;
private ServiceReference<Foo> fooRef;
private Foo mediated;

@Reference
void setAsync(Async async) {
    asyncService = async;
}

@Reference(service = Foo.class)
void setList(ServiceReference<Foo> foo) {
    fooRef = foo;
}

@Activate
void start() {
    mediated = asyncService.mediate(fooRef, Foo.class);
}

```

```
public synchronized void doStuff() {
    mediated.voidMethod();
    Promise<?> promise = asyncService
        .call();
    ...
}
```

### 138.2.4 Fire and Forget Calls

Sometimes a client does not require any notification that an async invocation has completed. In this case the client could use one of the [call\(\)](#) or [call\(R\)](#) methods and simply discard the returned Promise object. This, however, can be wasteful of resources. The act of resolving the Promise object may be expensive, for example it may involve serializing the return value over a network if the remote call was asynchronous.

If the client knows that no Promise object representing the result of the asynchronous task is needed then it can signal this to the Async Service. This allows the Async Service to better optimize the async invocation by not providing a result.

To indicate that the client wants to make a fire-and-forget style call the client invokes the mediator as normal, but then begins the asynchronous invocation using the [execute\(\)](#) method as show below.

```
private Async asyncService;
private ServiceReference<Foo> fooRef;

private Foo mediated;

@Reference
void setAsync(Async async) {
    asyncService = async;
}

@Reference(service = Foo.class)
void setList(ServiceReference<Foo> foo) {
    fooRef = foo;
}

@Activate
void start() {
    mediated = asyncService.mediate(fooRef, Foo.class);
}

public synchronized void doStuff() {
    mediated.someMethod();
    asyncService.execute();
    ...
}
```

Note that the [execute\(\)](#) method does still return a Promise. This Promise is not the same as the ones returned by [call\(\)](#) or [call\(R\)](#), its resolution value does not provide access to the result, but instead indicates whether the fire-and-forget call could be successfully started. If there is a failure which prevents the task from being executed then this is used to fail the returned promise.

### 138.2.5 Multi Threading

By their very definition asynchronous tasks do not run inline, and typically they will not run on the same thread as the caller. This is not, however, a guarantee. A valid implementation of the Async Service may have only one worker thread, which may be the thread currently running in the client code. Async invocations also have the same threading model as the Promise API. This means that callbacks may run on arbitrary threads, which may, or may not, be the same as the client thread, or the thread which executed the asynchronous work.

It is important for multi-threaded clients to note that calls to the mediator and Async Service must occur on the same thread. For example it is not supported to invoke a mediator using one thread, and then to begin the async invocation by calling the `call()`, `call(R)` or `execute()` method on a different thread.

## 138.3 Async Service

The Async Service is the primary interaction point between a client and the Async Service implementation. An Async Service implementation must expose a service implementing the `Async` interface. Clients obtain an instance of the Async Service using the normal OSGi service registry mechanisms, either directly using the OSGi framework API, or using dependency injection.

The Async Service is used to:

- Create async mediators
- Begin async invocations
- Obtain Promise objects representing the result of the async invocation

### 138.3.1 Using the Async Service

The first action that a client wishing to make an async invocation must take is to create an async mediator using one of the mediate methods. Once created the client invokes the method that should be run asynchronously, supplying the arguments that should be used. This call records the invocation, but does not start the asynchronous task. The asynchronous task begins when the client invokes one of the `call` or `execute` methods on the Async Service. The `call` methods must return a Promise representing the async invocation. The promise must resolve with the value returned by the async invocation, or fail with the failure thrown by the async invocation.

If the client attempts to begin an async invocation without first having called a method on the mediator object then the Async Service must detect this usage error and throw an `IllegalStateException` to the client. This applies to all methods that begin an async invocation.

### 138.3.2 Asynchronous Failures

There are a variety of reasons that async invocations may be started correctly by the client, but then fail without running the asynchronous task. In any of these cases the Promise representing the async invocation must fail with a Service Exception. This Service Exception must be initialized with a type of `ASYNC_ERROR`. If there is no promise representing the async invocation then there is no way to notify the client of the failure, therefore the Service Exception must be logged by the Async Service using all available Log Service implementations.

The following list of scenarios is not exhaustive, but indicates failure scenarios that must result in a Service Exception with a type of `async`

- If the client is using a service reference backed mediator and the client bundle's bundle context becomes invalid before looking up the target service.
- If the client is using a service reference backed mediator and the service is unregistered before making the async invocation.

- If the client is using a service reference backed mediator and the service lookup returns null
- If the Async Service is unable to accept new work, for example it is in the process of being shut down.
- If the type of the mediator object does not match the type of the service object to be invoked.

### 138.3.3 Thread Safety and Instance Sharing

Implementations of the Async Service must be thread safe and may be used simultaneously across multiple clients and from multiple threads within the same client. Whilst the Async Service is able to be used across multiple threads, if a client wishes to make an async invocation then the call to the mediator and the call to begin the async invocation must occur on the same thread. The returned Promise may then be shared between threads if required.

It is expected, although not required, that the Async Service implementation will use a Service Factory to create customized implementations for each client bundle. This simplifies the tracking of the relevant client bundle context to use when performing service lookups on the client bundle's behalf. Clients should therefore not share instances of the Async Service with other bundles. Instead both bundles should obtain their own instances from the service registry.

### 138.3.4 Service Object Lifecycle Management

If the Async Service is being used to call an OSGi service object and the service reference is available then the service object should be looked up immediately before the asynchronous task begins executing. This ensures that the service is still available at the point it is eventually called. Any call to `getService` must have a corresponding call to `ungetService` after the mediated method invoked has returned and, if available, the promise is resolved, but before the asynchronous task releases its thread of execution.

## 138.4 The Async Mediator

Async mediators are dynamically created objects that have the same type or interface as the object being mediated, and are used to record method invocations and arguments. Mediator objects are specific to an Async Service implementation, and must only be used in conjunction with the Async Service object that they were created by.

Mediators may be created either from a `ServiceReference` or from a service object. The actions and overall result are similar for both the `mediate(ServiceReference,Class)` and `mediate(T,Class)` methods, with the primary difference being that mediated objects created from a `ServiceReference` will validate whether the service object is still available immediately before the asynchronous task is executed.

### 138.4.1 Building the Mediator Object

The client passes in a `Class` indicating the type that should be mediated. If the class object represents an interface type then the generated mediator object must implement that interface. If the class object represents a Java class type then the mediator object must either be an instance of that type or extend it.

When building a mediator object the Async Service has the opportunity to detect numerous problems, for example if the referenced service to be mediated has been unregistered. Although fail-fast behavior is usually preferable, in this case it would force the client to handle errors in two places; both when creating the mediator, and for the returned Promise. To simplify client usage, error cases detected when creating a mediator must not prevent the mediator from being created and must not result in an exception being thrown. The only reason that the Async Service may fail to create a mediator is if the class object passed in cannot be mediated.

There are three reasons why the Async Service may not be able to mediate a class type:

- The class object passed in represents a final type.
- The class object passed in represents a type that has no zero-argument constructor.
- The class object passed in represents a type which has one or more public final methods present in its type hierarchy (other than those declared by `java.lang.Object`).

If any of these constraints are violated and prevent the Async Service from creating a mediator then the Async Service must throw an `IllegalArgumentException`.

### 138.4.2 Async Mediator Behaviors

When invoked, the Async mediator must record the method call, and its arguments, and then return rapidly and should avoid performing blocking operations. The values returned by the mediator object are opaque, and the client should not attempt to interpret the returned value. The value may be null (or null-like in the case of primitives) or contain implementation specific information. If the mediated method call has a return type, specifically it is non-void, then this object must be passed to the Async Service's call method when beginning the async invocation

Async mediators should make a best-effort attempt to detect incorrect API usage from the client. If this incorrect usage is detected then the mediator object must throw an `IllegalStateException` when invoked. An example of incorrect usage that must be detected is when a client makes multiple invocations on a single mediator object from the same thread without making any calls to the Async Service.

After a usage error has been detected and an `IllegalStateException` has been thrown the mediator object must be reset so that a subsequent invocation from the client thread can proceed normally.

### 138.4.3 Thread Safety and Instance Sharing

Async mediators, like instances of the Async Service, are required to be thread safe. Clients may therefore share mediator objects across threads, and can safely store them as instance fields. Whilst mediators are thread safe, if a client wishes to make an async invocation then the call to the mediator and the call to `call()` or `call(R)` must occur on the same thread. The returned Promise may then be shared between threads if required.

Async mediators created from `ServiceReference` objects remain directly associated with the service reference and client bundle after creation. Clients should therefore not share mediator objects with other bundles. Instead each bundle should create its own mediator.

## 138.5 Fire and Forget Invocations

The Async Service provides `call()` and `call(R)` methods for clients to use when they wish to receive results from asynchronous tasks. Clients that do not need the result can simply discard the returned Promise object. This, however, can be wasteful of resources. The act of resolving the Promise object may be expensive, for example it may involve serializing the return value over a network.

To address this use case the Async Service provides the `execute()` method, which behaves similarly to `call()` and `call(R)`, but does not provide access to the eventual result. Instead the `execute()` method returns a Promise that indicates whether the fire-and-forget call is able to be successfully started.

The returned Promise must be resolved with null if the asynchronous task begins executing successfully. There is no *happens-before* relationship required, meaning that if the Promise resolves successfully then the task may, or may not, have started or finished. The primary usage of the Promise is actually to detect failures. If the fire-and-forget task cannot be executed for some reason, for example the backing service has been unregistered, then the returned promise must be failed appropriately using the same rules as defined in *Asynchronous Failures* on page 1057. If the returned Promise is failed then the fire-and-forget task has not executed and will not execute in the future.

## 138.6 Delegating to Asynchronous Implementations

Some service APIs are already asynchronous in operation, and others are partly asynchronous, in that some methods run asynchronously and others do not. There are also services which have a synchronous API, but could run asynchronously because they are a proxy to another service. A good example of this kind of service is a remote service. Remote services are local views of a remote endpoint, and depending upon the implementation of the endpoint it may be possible to make the remote call asynchronously, optimizing the thread usage of any local asynchronous call.

Services that already have some level of asynchronous support may advertise this to clients and to the Async Service by having their service object be an instance of `AsyncDelegate`. The service object can be cast to `AsyncDelegate` to be used by the Async Service implementation, or by the client directly, to make an asynchronous call on the service.

Because the Async Delegate behavior is transparently handled by the Async Service, clients of the Async Service do not need to know whether the service object is an instance of `AsyncDelegate` or not. Their usage pattern can remain unchanged.

When making an async invocation, the Async Service must check to see whether the service object is an instance of `AsyncDelegate`. If the service object is an instance of `AsyncDelegate`, then the Async Service must attempt to delegate the asynchronous call. The exact delegation operation depends on whether a Promise result is required.

### 138.6.1 Obtaining a Promise from an Async Delegate

If the result of the method invocation is needed by the client, then the Async Service must attempt to delegate to the `async(Method, Object[])` method. The delegation proceeds as follows:

- If the call to the Async Delegate returns a Promise, then the Promise returned by the Async Service must be resolved with that Promise.
- If the call to the Async Delegate throws an exception, then the Promise returned by the Async Service must be failed with the exception.
- If the Async Delegate is unable to optimize the call and returns null from the `async(Method, Object[])` method, the Async Service must continue processing the async invocation, treating the service as a normal service object.

### 138.6.2 Delegating Fire and Forget Calls to an Async Delegate

If the result of the method invocation is not needed by the client, then the Async Service must attempt to delegate to the `execute(Method, Object[])` method. This gives the Async Delegate implementation the opportunity to further optimize its processing. The delegation proceeds as follows:

- If the call to the Async Delegate returns true, then the Promise returned by the Async Service must be resolved with null.
- If the call to the Async Delegate throws an exception, then the Promise returned by the Async Service must be failed with the exception.
- If the Async Delegate is unable to optimize the call and returns false from the `execute(Method, Object[])` method, the Async Service must continue processing the async invocation, treating the service as a normal service object.

### 138.6.3 Lifecycle for Service Objects When Delegating

If an Async Delegate implementation accepts an asynchronous task, via a call to either `execute(Method, Object[])` or `async(Method, Object[])`, then it is responsible for continuing to process the work until completion. This means that if the service implementing Async Delegate is unregistered for some reason, then the task must be properly cleaned up and succeed or fail as appropriate.



If the Async Service implementation used a service reference to obtain the service, then it must release the service object after the task has been accepted. This means that if the service object is provided by a service factory, then the service object should take extra care not to destroy its internal state when released. The service object must remain valid until all executing asynchronous tasks associated with the service object are either completed or failed.

If an Async Delegate implementation rejects an asynchronous task, by returning false or null, the Async Service implementation must take over the asynchronous invocation of the method. In this case, if the Async Service implementation used a service reference to obtain the service, the Async Service must not release the service object until the asynchronous task is completed.

If an Async Delegate implementation throws an exception and the Async Service implementation used a service reference to obtain the service, then the service object must be released immediately.

## 138.7 Capabilities

Implementations of the Asynchronous Service specification must provide the following capabilities.

- A capability in the `osgi.implementation` namespace declaring the implemented specification to be `osgi.async`. This capability must also declare a uses constraint for the `org.osgi.service.async` and `org.osgi.service.async.delegate` packages. For example:

```
Provide-Capability: osgi.implementation;
                   osgi.implementation="osgi.async";
                   version:Version="1.0";
                   uses:="org.osgi.service.async,org.osgi.service.async.delegate"
```

This capability must follow the rules defined for the *osgi.implementation Namespace* on page 997.

- A capability in the `osgi.service` namespace representing the [Async](#) service. This capability must also declare a uses constraint for the `org.osgi.service.async` package. For example:

```
Provide-Capability: osgi.service;
                   objectClass:List<String>="org.osgi.service.async.Async";
                   uses:="org.osgi.service.async"
```

This capability must follow the rules defined for the *osgi.service Namespace* on page 997.

## 138.8 Security

Asynchronous Services implementations must be careful to avoid elevating the privileges of client bundles when calling services asynchronously, and also to avoid restricting the privileges of clients that are permitted to make a call. This means that the implementation must:

- Be granted `AllPermission`. As the Async Service will always be on the stack when invoking a service object asynchronously it must be granted `AllPermission` so that it does not interfere with security any checks made by the service object.
- Establish the caller's `AccessControlContext` in a worker thread before starting to call the service object. This prevents a bundle from being able to call a service asynchronously that it would not normally be able to call. The `AccessControlContext` must be collected during any call to `call()`, `call(R)` or `execute()`.
- Use a `doPrivileged` block when mediating a concrete type. A no-args constructor in a concrete type may perform actions that the client may not have permission to perform. This should not

prevent the client from mediating the object, as the client is not directly performing these actions.

- If the mediator object was created using a service reference, then the Async Services implementation must use the client's bundle context when retrieving the target service. If the service lookup occurs on a worker thread, then the lookup must use the `AccessControlContext` collected during the call to `call()`, `call(R)` or `execute()`. This prevents the client bundle from being able to make calls on a service object that they do not have permission to obtain, and ensures that an appropriately customized object is returned if the service is implemented using a service factory.

Further security considerations can be addressed using normal OSGi security rules. For example access to the Async Service can be controlled using `ServicePermission[...Async, GET]`.

## 138.9 org.osgi.service.async

Asynchronous Services Package Version 1.0.

Bundles wishing to use this package must list the package in the `Import-Package` header of the bundle's manifest. This package has two types of users: the consumers that use the API in this package and the providers that implement the API in this package.

Example import for consumers using the API in this package:

```
Import-Package: org.osgi.service.async; version="[1.0,2.0]"
```

Example import for providers implementing the API in this package:

```
Import-Package: org.osgi.service.async; version="[1.0,1.1]"
```

### 138.9.1 Summary

- Async - The Asynchronous Execution Service.

### 138.9.2 public interface Async

The Asynchronous Execution Service. This can be used to make asynchronous invocations on OSGi services and objects through the use of a mediator object.

Typical usage:

```
Async async = ctx.getService(asyncRef);

ServiceReference<MyService> ref = ctx.getServiceReference(MyService.class);

MyService mediator = async.mediate(ref, MyService.class);

Promise<BigInteger> result = async.call(mediator.getSumOverAllValues());
```

The `Promise` API allows callbacks to be made when asynchronous tasks complete, and can be used to chain Promises.

Multiple asynchronous tasks can be started concurrently, and will run in parallel if the Async Service has threads available.

*Provider Type* Consumers of this API must not implement this type

#### 138.9.2.1 public Promise<R> call(R r)

*Type Arguments* <R>

*r* The return value of the mediated call, used for type information.

- Invoke the last method call registered by a mediated object as an asynchronous task. The result of the task can be obtained using the returned Promise.

Typically the parameter for this method will be supplied inline like this:

```
ServiceReference<I> s = ...;
I i = async.mediate(s, I.class);
Promise<String> p = async.call(i.foo());
```

*Returns* A Promise which can be used to retrieve the result of the asynchronous task.

### 138.9.2.2 **public Promise<?> call()**

- Invoke the last method call registered by a mediated object as an asynchronous task. The result of the task can be obtained using the returned Promise.

Generally it is preferable to use call(Object) like this:

```
ServiceReference<I> s = ...;
I i = async.mediate(s, I.class);
Promise<String> p = async.call(i.foo());
```

However this pattern does not work for void methods. Void methods can therefore be handled like this:

```
ServiceReference<I> s = ...;
I i = async.mediate(s, I.class);
i.voidMethod();
Promise<?> p = async.call();
```

*Returns* A Promise which can be used to retrieve the result of the asynchronous task.

### 138.9.2.3 **public Promise<Void> execute()**

- Invoke the last method call registered by a mediated object as a "fire-and-forget" asynchronous task. This method should be used by clients in preference to call() and call(Object) when no callbacks, or other features of Promise, are needed.

The advantage of this method is that it allows for greater optimization of the underlying asynchronous task. Clients are therefore likely to see better performance when using this method compared to using call(Object) or call() and ignoring the returned Promise. The Promise returned by this method is different from the Promise returned by call(Object) or call(), in that the returned Promise will resolve when the fire-and-forget task is successfully started, or fail if the task cannot be started. Note that there is no *happens-before* relationship and the returned Promise may resolve before or after the fire-and-forget task starts, or completes.

Typically this method is used like call():

```
ServiceReference<I> s = ...;
I i = async.mediate(s, I.class);
i.someMethod();
Promise<Void> p = async.execute();
```

*Returns* A Promise representing whether the fire-and-forget task was able to start.

### 138.9.2.4 **public T mediate(T target, Class<T> iface)**

*Type Arguments* <T>

*target* The service object to mediate.

*iface* The type that the mediated object should provide.

- Create a mediator for the specified object. The mediator is a generated object that registers the method calls made against it. The registered method calls can then be run asynchronously using either the `call(Object)`, `call()`, or `execute()` method.

The values returned by method calls made on a mediated object are opaque and should not be interpreted.

Normal usage:

```
I s = ...;
I i = async.mediate(s, I.class);
Promise<String> p = async.call(i.foo());
```

*Returns* A mediator for the service object.

*Throws* `IllegalArgumentException`– If the type represented by `iface` cannot be mediated.

### 138.9.2.5 **public T mediate(ServiceReference<? extends T> target, Class<T> iface)**

*Type Arguments* <T>

*target* The service reference to mediate.

*iface* The type that the mediated object should provide.

- Create a mediator for the specified service. The mediator is a generated object that registers the method calls made against it. The registered method calls can then be run asynchronously using either the `call(Object)`, `call()`, or `execute()` method.

The values returned by method calls made on a mediated object are opaque and should not be interpreted.

This method differs from `mediate(Object, Class)` in that it can track the availability of the specified service. This is recommended as the preferred option for mediating OSGi services as asynchronous tasks may not start executing until some time after they are requested. Tracking the validity of the `ServiceReference` for the service ensures that these tasks do not proceed with an invalid object.

Normal usage:

```
ServiceReference<I> s = ...;
I i = async.mediate(s, I.class);
Promise<String> p = async.call(i.foo());
```

*Returns* A mediator for the service object.

*Throws* `IllegalArgumentException`– If the type represented by `iface` cannot be mediated.

## 138.10 org.osgi.service.async.delegate

Asynchronous Services Delegation Package Version 1.0.

Bundles wishing to use this package must list the package in the `Import-Package` header of the bundle's manifest. This package contains only interfaces that are implemented by consumers.

Example import for consumers using the API in this package:

```
Import-Package: org.osgi.service.async.delegate; version="[1.0,2.0)"
```

### 138.10.1 Summary

- `AsyncDelegate` - This interface is used by services to allow them to optimize Asynchronous calls where they are capable of executing more efficiently.

## 138.10.2 public interface AsyncDelegate

This interface is used by services to allow them to optimize Asynchronous calls where they are capable of executing more efficiently.

This may mean that the service has access to its own thread pool, or that it can delegate work to a remote node, or act in some other way to reduce the load on the Asynchronous Services implementation when making an asynchronous call.

### 138.10.2.1 public Promise<T> async(Method m, Object[] args) throws Exception

*m* The method to be asynchronously invoked.

*args* The arguments to be used to invoke the method.

- Invoke the specified method as an asynchronous task with the specified arguments.

This method can be used by clients, or the Async Service, to optimize Asynchronous execution of methods.

When called, this method should invoke the supplied method using the supplied arguments asynchronously, returning a Promise that can be used to access the result.

If the method cannot be executed asynchronously by this method then null must be returned.

*Returns* A Promise representing the asynchronous result, or null if this method cannot be asynchronously invoked.

*Throws* Exception— An exception should be thrown only if there was a serious error that prevented the asynchronous task from starting. For example, the specified method does not exist on this object. Exceptions must not be thrown to indicate that the call does not support asynchronous invocation. Instead this method must return null. Exceptions must also not be thrown to indicate a failure from the execution of the underlying method. This must be handled by failing the returned Promise.

### 138.10.2.2 public boolean execute(Method m, Object[] args) throws Exception

*m* The method to be asynchronously invoked.

*args* The arguments to be used to invoke the method.

- Invoke the specified method as a "fire-and-forget" asynchronous task with the specified arguments.

This method can be used by clients, or the Async Service, to optimize Asynchronous execution of methods.

When called, this method should invoke the specified method using the specified arguments asynchronously. This method differs from `async(Method, Object[])` in that it does not return a Promise. This method therefore allows the implementation to perform more aggressive optimizations because the end result of the invocation does not need to be returned to the caller.

If the method cannot be executed asynchronously by this method then false must be returned.

*Returns* true if the asynchronous execution request has been accepted, or false if this method cannot be asynchronously invoked by the AsyncDelegate.

*Throws* Exception— An exception should be thrown only if there was a serious error that prevented the asynchronous task from starting. For example, the specified method does not exist on this object. Exceptions must not be thrown to indicate that the call does not support asynchronous invocation. Instead this method must return false. Exceptions must also not be thrown to indicate a failure from the execution of the underlying method.

## 138.11 References

- [1] *OSGi Core Release 6*

<http://www.osgi.org/Specifications/HomePage>

# 140 Http Whiteboard Specification

## Version 1.0

### 140.1 Introduction

Servlets have become a popular and widely supported mechanism for providing dynamic content on the Internet. While servlets are defined in the [4] *Java Servlet 3.1 Specification*, the OSGi Http Whiteboard Specification provides a light and convenient way of using servlets, servlet filters, servlet listeners and web resources in an OSGi environment through the use of the [7] *Whiteboard Pattern*.

The Http Whiteboard specification supports:

- *Registering Servlets* - Registering a servlet in the Service Registry makes it available to be bound to an endpoint to serve content over the network.
- *Registering Servlet Filters* - Servlet filters support pre- and post-processing of servlet requests and responses. Servlet filters can be registered in the Service Registry to include them in the handling pipeline.
- *Registering Resources* - Resources such as HTML files, JavaScript, image files, and other static resources can be made available over the network by registering resource services.
- *Registering Servlet Listeners* - The servlet specification defines a variety of listeners, which receive callbacks when certain events take place.

Implementations of this specification can support the following versions of the HTTP protocol:

- [1] *HTTP 1.0 Specification RFC-1945*
- [2] *HTTP 1.1 Specifications RFCs 7230-7235*
- [3] *HTTP/2 Specifications*

Alternatively, implementations of this service can support other protocols if these protocols can conform to the semantics of the Java Servlet API.

Http Whiteboard implementations must support version 3.1 of the Java Servlet API.

#### 140.1.1 Entities

This specification defines the following entities:

- *Http Whiteboard service* - An object registered in the Service Registry under one of the Whiteboard service interfaces defined by this specification.
- *Http Whiteboard implementation* - An implementation that processes Http Whiteboard services.
- *Http Service Runtime service* - Service providing runtime introspection into the Http Whiteboard implementation.
- *Listener* - Various listeners can be registered to receive notifications about servlet or Http Session events.
- *Resource Service* - A service that binds static resources.
- *Servlet* - Component that dynamically generates web pages or other resources provided over the network.

- *Servlet Context Helper* - A service to control the behavior of the Servlet Context.
- *Servlet Filter* - Can be used to augment or transform web resources or for cross-cutting functionality such as security, common widgets or otherwise.

Figure 140.1 *Http Whiteboard Overview Diagram*

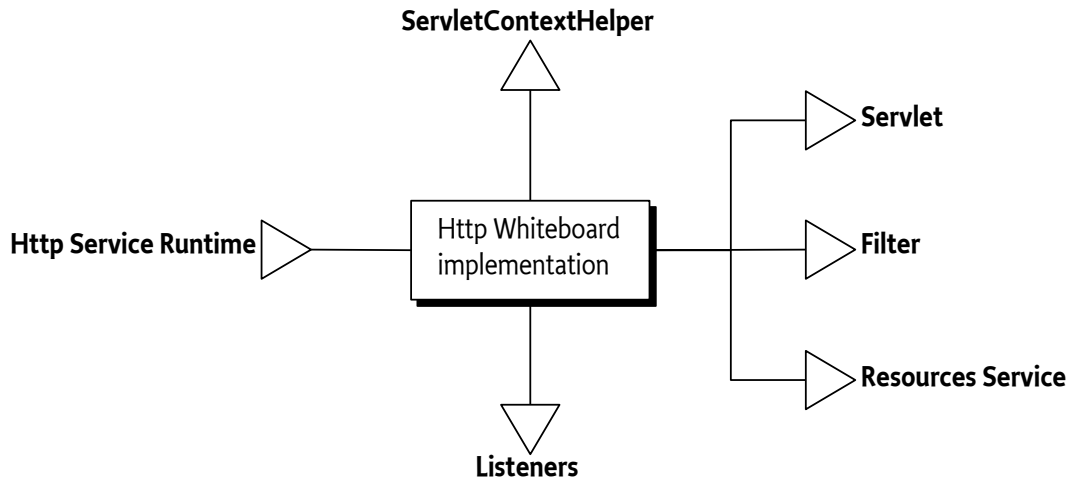

## 140.2 The Servlet Context

The servlet specification defines the `ServletContext` which is provided to servlets at runtime by the container. Whiteboard services defined by this specification are also provided with a `ServletContext`. The behavior of this Servlet Context can be influenced by providing a [ServletContextHelper](#) service. A custom `ServletContextHelper` can provide resources, mime-types, handle security and supports a number of methods from the `ServletContext`.

The Http Whiteboard implementation must create a separate `ServletContext` instance for each `ServletContextHelper` service. Whiteboard services can be associated with the Servlet Context Helper by using the `osgi.http.whiteboard.context.select` property. If this property is not set, the *default* Servlet Context Helper is used.

To achieve the required behavior for `ServletContext.getClassLoader()` each bundle must be provided with a separate Servlet Context instance to serve the classloader of the Whiteboard services for that bundle. For more information see `getClassLoader()` in Table 140.2 on page 1071.

Some implementations of the `ServletContextHelper` may be implemented using a Service Factory, for example to provide resources from the associated bundle, as the *default* implementation does. Therefore the Whiteboard implementation must get the Servlet Context Helper using the Bundle Context of the bundle that registered the Whiteboard service.

Some environments may use [8] *Core Service Hooks* to isolate `ServletContextHelper` service registrations. For example, *Subsystem Service Specification* on page 925. The Whiteboard implementation must check that the bundle registering the Whiteboard service has the ability to find the `ServletContextHelper` service before allowing the Whiteboard service to bind to the Servlet Context Helper. This can be done by calling one of the `getServiceReferences` methods on the Bundle Context of bundle that registered the Whiteboard service.



Table 140.1 Service registration properties for ServletContextHelper services.

Service Property Name	Type	Description
osgi.http.whiteboard.context.name	String <i>required</i>	Name of the Servlet Context Helper. This name can be referred to by Whiteboard services via the <code>osgi.http.whiteboard.context.select</code> property. The syntax of the name is the same as the syntax for a Bundle Symbolic Name. The default Servlet Context Helper is named <code>default</code> . To override the default, register a custom ServletContextHelper service with the name <code>default</code> . If multiple Servlet Context Helper services are registered with the same name, the one with the highest Service Ranking is used. In case of a tie, the service with the lowest service ID wins. In other words, the normal OSGi service ranking applies.  Registrations with an invalid or unspecified name are not used and reflected in the failure DTOs. See <a href="#">HTTP_WHITEBOARD_CONTEXT_NAME</a> .
osgi.http.whiteboard.context.path	String <i>required</i>	Additional prefix to the context path for servlets. This property is mandatory. Valid characters are specified in IETF RFC 3986, section 3.3. The context path of the default Servlet Context Helper is <code>/</code> . A custom default Servlet Context Helper may use an alternative path. If the path is invalid or unspecified, the service is not used and reflected in the failure DTOs. See <a href="#">HTTP_WHITEBOARD_CONTEXT_PATH</a> .
context.init.*	String <i>optional</i>	Properties starting with this prefix are provided as init parameters through the <code>ServletContext.getInitParameter()</code> and <code>ServletContext.getInitParameterNames()</code> methods. The <code>context.init.</code> prefix is removed from the parameter name. See <a href="#">HTTP_WHITEBOARD_CONTEXT_INIT_PARAM_PREFIX</a> .

Multiple ServletContextHelper services can have identical or overlapping `osgi.http.whiteboard.context.path` values. A matching servlet or resource is located as follows:

1. The Servlet Context Helper service with the longest matching path is matched first.
2. In the case of two Servlet Context Helpers with the same path, the service with the highest ranking is searched first for a match. In the case of a tie, the lowest service ID is searched first.

For example, if two ServletContextHelper services are registered as follows

```
osgi.http.whiteboard.context.path = /foo
osgi.http.whiteboard.context.path = /foo/bar
```

Then a request for `http://localhost/foo/bar/someServlet` is looked up in the following order:

1. `/foo/bar` context looking for a pattern to match `/someServlet`
2. `/foo` context looking for a pattern to match `/bar/someServlet`

Note that whole path segments must match. Therefore the following request can only be handled by the Servlet Context Helper registered under the `/foo` path: `http://localhost/foo/bars/someOtherServlet`.

For details on the association process between servlet, servlet filter, resource and listener services and the ServletContextHelper see *Common Whiteboard Properties* on page 1073.

If a Servlet Context Helper can not be used, for example because it is shadowed by another Servlet Context Helper service with the same name, but with a higher ranking, this is reflected in the

[FailedServletContextDTO](#). Similarly, if an alternative default Servlet Context Helper is provided, the default Servlet Context Helper provided by the Http Whiteboard implementation is not used and represented in a failure DTO.

An example Servlet Context Helper defined using Declarative Services annotations can be found below, it prefixes the path with /myapp for any associated whiteboard service. Additionally, it serves static resources from a non-standard location, a content delivery network. Other methods use the default ServletContextHelper implementation.

```
@Component(service = ServletContextHelper.class,
    scope = ServiceScope.BUNDLE,
    property = {
        "osgi.http.whiteboard.context.name=my-context",
        "osgi.http.whiteboard.context.path=/myapp"})
public class CDNServletContextHelper extends ServletContextHelper {
    public URL getResource(String name) {
        try {
            return new URL("http://acmecdn.com/myapp/" + name);
        } catch (MalformedURLException e) {
            return null;
        }
    }
}
```

The following sections outline the methods a custom [ServletContextHelper](#) can override and the behavior of the *default* implementation.

#### 140.2.1 **String getMimeType(String)**

Called to provide the MIME type for a resource.

*Default Behavior* - Always returns null.

#### 140.2.2 **String getRealPath(String)**

Called to support the ServletContext.getRealPath() method.

*Default Behavior* - Always returns null.

#### 140.2.3 **URL getResource(String)**

Obtain a URL for a given resource request.

*Default Behavior* - Assumes the resources are in the bundle registering the Whiteboard service. Its Bundle.getEntry() method is called to obtain a URL to the resource. The default Servlet Context Helper implementation assumes the path to be relative to the bundle's root.

#### 140.2.4 **Set<String> getResourcePaths(String)**

Called to support the ServletContext.getResourcePaths() method. Returns all the matching resources for the path.

*Default Behavior* - Assumes the resources are in the bundle registering the Whiteboard service. Its Bundle.findEntries() method is called to obtain the listing.

#### 140.2.5 **boolean handleSecurity(HttpServletRequest, HttpServletResponse)**

This method is invoked to handle implementation-defined security on the request. It is invoked before the request is sent to the filter-servlet pipeline.

*Default Behavior* - Always returns true.

## 140.2.6 Behavior of the Servlet Context

The ServletContext provided to Whiteboard services is based on the associated ServletContextHelper, Whiteboard service registration properties and the underlying servlet container.

Methods to programmatically add servlets, servlet filters and listeners are not supported on the ServletContext. Such functionality is available by registering these entities as Whiteboard services.

Table 140.2 Behavior of ServletContext methods.

ServletContext method	Since	Description
addFilter(...)	3.0	Throws UnsupportedOperationException.
addListener(...)	3.0	Throws UnsupportedOperationException.
addServlet(...)	3.0	Throws UnsupportedOperationException.
createFilter(Class)	3.0	Throws UnsupportedOperationException.
createListener(Class)	3.0	Throws UnsupportedOperationException.
createServlet(Class)	3.0	Throws UnsupportedOperationException.
declareRoles(String ...)	3.0	Throws UnsupportedOperationException.
getAttribute(String)	2.0	Stored per ServletContextHelper. The Servlet Context keeps a set of attributes per Servlet Context Helper.
getAttributeNames()	2.1	Stored per ServletContextHelper. The Servlet Context keeps a set of attributes per Servlet Context Helper.
getClassLoader()	3.0	Returns the class loader of the bundle that registered the Whiteboard service. An implementation of this specification can achieve this by returning separate façades of the ServletContext to each Whiteboard service. Each façade accesses the Whiteboard service's Bundle Wiring to obtain its classloader.
getContext(String)	2.1	Backed by the Servlet Container.
getContextPath()	2.5	Return the web context path of the Servlet Context. This takes into account the <code>osgi.http.whiteboard.context.path</code> of the Servlet Context Helper and the path of the Http runtime.
getDefaultSessionTrackingModes()	3.0	Backed by the Servlet Container.
getEffectiveMajorVersion()	3.0	Backed by the Servlet Container.
getEffectiveMinorVersion()	3.0	Backed by the Servlet Container.
getEffectiveSessionTrackingModes()	3.0	Backed by the Servlet Container.
getFilterRegistration(String)	3.0	Backed by the Servlet Container.
getFilterRegistrations()	3.0	Backed by the Servlet Container.
getInitParameter(String)	2.2	From <code>context.init.*</code> service registration properties.
getInitParameterNames()	2.2	From <code>context.init.*</code> service registration properties.
getJspConfigDescriptor()	3.0	Returns null.
getMajorVersion()	2.1	Backed by the Servlet Container.
getMimeType(String)	2.1	Backed by the ServletContextHelper.
getMinorVersion()	2.1	Backed by the Servlet Container.

ServletContext method	Since	Description
getNamedDispatcher(String)	2.2	Provides the Whiteboard servlet with the specified name, provided through the <code>osgi.http.whiteboard.servlet.name</code> property, if associated with this Servlet Context Helper. If multiple servlets have the same name and are associated with this Servlet Context Helper then the highest ranked servlet is used. In the case of a tie, the one with the lowest service ID is used.
getRealPath(String)	2.0	Backed by the ServletContextHelper.
getResource(String)	2.1	Backed by the ServletContextHelper.
getRequestDispatcher(String)	2.1	If the argument matches a servlet associated with this Servlet Context Helper, this will be returned.
getResourceAsStream(String)	2.1	Backed by the ServletContextHelper.
getResourcePaths(String)	2.3	Backed by the ServletContextHelper.
getServlet(String)	2.0	Deprecated. Backed by the Servlet Container.
getServletContextName()	2.2	The name of the ServletContextHelper provided via the <code>osgi.http.whiteboard.context.name</code> service property.
getServletNames()	2.0	Deprecated. Backed by the Servlet Container.
getServletRegistration(String)	3.0	Backed by the Servlet Container.
getServletRegistrations()	3.0	Backed by the Servlet Container.
getServlets()	2.0	Deprecated. Backed by the Servlet Container.
getServerInfo()	2.0	Backed by the Servlet Container.
getSessionCookieConfig()	3.0	Returns a <code>SessionCookieConfig</code> object. This object is read-only and all setters throw a <code>IllegalStateException</code> .
getVirtualServerName()	3.1	Backed by the Servlet Container.
log(String)	2.0	Backed by the Servlet Container.
log(Exception, String)	2.0	Deprecated. Backed by the Servlet Container.
log(String, Throwable)	2.1	Backed by the Servlet Container.
removeAttribute(String)	2.1	Stored per ServletContextHelper. The Servlet Context keeps a set of attributes per Servlet Context Helper.
setAttribute(String, Object)	2.1	Stored per ServletContextHelper. The Servlet Context keeps a set of attributes per Servlet Context Helper.
setInitParameter(String, String)	3.0	Throws <code>IllegalStateException</code> . The ServletContext has already been initialized.
setSessionTrackingModes(Set)	3.0	Throws <code>IllegalStateException</code> . The ServletContext has already been initialized.

### 140.2.7 Relation to the Servlet Container

Implementations of this specification will often be backed by existing servlet containers or a Java EE application server. There may also exist implementations which bridge into a servlet container into which the OSGi Framework has been deployed as a Web Application.

In bridged situations the Http Whiteboard implementation will live in one servlet context and all Whiteboard services registered by this implementation will be backed by the same underlying Servlet Context. However, to exhibit the behavior described in Table 140.2 on page 1071 different Servlet Context objects may be required. Therefore an implementation of this specification may

need to create additional ServletContext objects which delegate certain functionality to the ServletContextHelper and other functionality to the Servlet Context of the Web Application, yet further functionality can be obtained otherwise. In such cases the relationship may look like the below figure.

Figure 140.2 Servlet Context entities and their relation

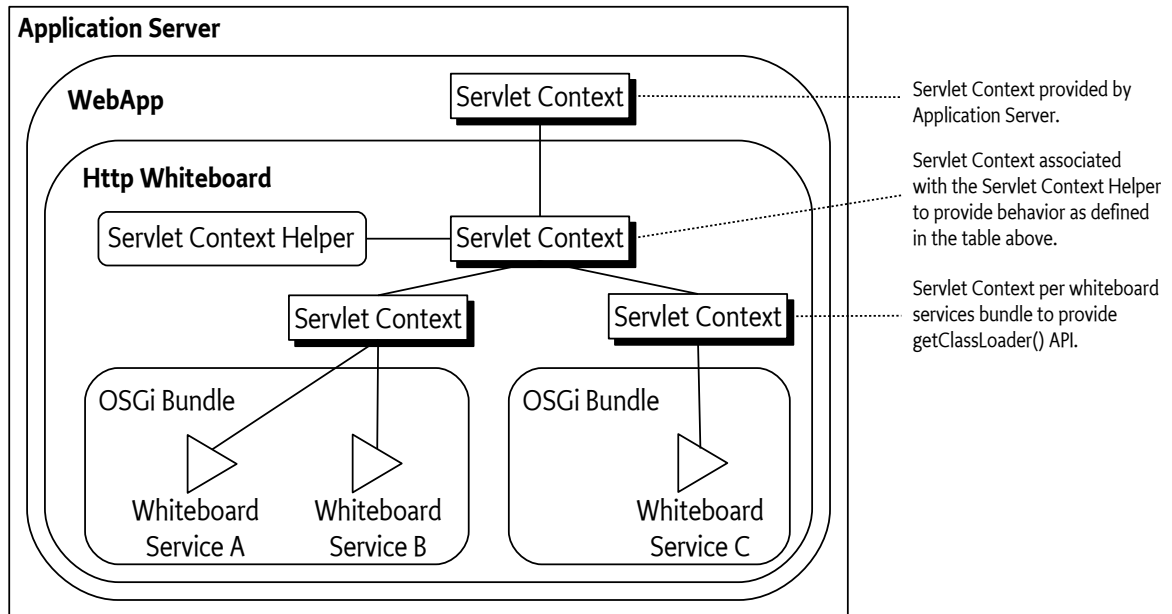

Where Table 140.2 on page 1071 states *Backed by the Servlet Container* and the Http Whiteboard implementation is deployed in bridged mode, the API call can be forwarded to the top-level Servlet Context. If the Http Whiteboard implementation is not deployed in bridged mode, it must provide another means to handle these APIs.

In bridged deployments, the implementation needs to ensure the following:

1. That Whiteboard services are provided with the correct ServletContext keeping in mind that each distinct ServletContextHelper should be associated with a separate ServletContext object, which in turn may delegate certain requests to the underlying shared ServletContext as described in the table above.
2. That Http Sessions are not shared amongst servlets registered with different ServletContextHelpers. That is, `HttpRequest.getSession()` calls must provide different sessions per associated ServletContextHelper. Http Sessions are defined in chapter 7 of the [4] *Java Servlet 3.1 Specification*.

## 140.3 Common Whiteboard Properties

Whiteboard servlet, servlet filter, resource and listener services support common service registration properties to associate them with a ServletContextHelper and/or a Http Whiteboard implementation.

Table 140.3

Common properties

Service Property Name	Type	Description
<code>osgi.http.whiteboard.context.select</code>	String <i>optional</i>	<p>An LDAP-style filter to select the associated <a href="#">ServletContextHelper</a> service to use. Any service property of the Servlet Context Helper can be filtered on. If this property is missing the default Servlet Context Helper is used.</p> <p>For example, to select a Servlet Context Helper with name <code>myCTX</code> provide the following value:</p> <pre>(osgi.http.whiteboard.context.name=myCTX)</pre> <p>To select all Servlet Context Helpers provide the following value:</p> <pre>(osgi.http.whiteboard.context.name=*)</pre> <p>If no matching context exists this is reflected in the failure DTOs. See <a href="#">HTTP_WHITEBOARD_CONTEXT_SELECT</a>.</p>
<code>osgi.http.whiteboard.target</code>	String <i>optional</i>	<p>The value of this service property is an LDAP-style filter expression to select the Http Whiteboard implementation(s) to handle this Whiteboard service. The LDAP filter is used to match <a href="#">HttpServiceRuntime</a> services. Each Http Whiteboard <i>implementation</i> exposes exactly one <a href="#">HttpServiceRuntime</a> service. This property is used to associate the Whiteboard service with the Http Whiteboard implementation that registered the <a href="#">HttpServiceRuntime</a> service. If this property is not specified, all Http Whiteboard implementations can handle the service. See <a href="#">HTTP_WHITEBOARD_TARGET</a>.</p>

If multiple Servlet Context Helper services match the `osgi.http.whiteboard.context.select` property the servlet, filter, resource or listener will be registered with all these Servlet Context Helpers. To avoid multiple `init()` and `destroy()` calls on the same instance, servlets and filters should be registered as Prototype Service Factory.

## 140.4 Registering Servlets

Servlets can be registered with the Http Whiteboard implementation by registering them as Whiteboard services. This means that Servlet implementations are registered in the Service Registry under the `javax.servlet.Servlet` interface.

Servlets are registered with one or more pattern through the `osgi.http.whiteboard.servlet.pattern` service property. Each pattern defines the URL context that will trigger the servlet to handle the request. They are defined by the [4] *Java Servlet 3.1 Specification* in section 12.2, *Specification of Mappings*. Note that these mapping rules are slightly different than those defined in the *Http Service Specification* on page 45. The mapping rules are:

- A string beginning with a '/' character and ending with a '/\*' suffix is used for path mapping.
- A string beginning with a "\*" prefix is used as an extension mapping.

- The empty string ("") is a special URL pattern that exactly maps to the application's context root. That is, requests of the form `http://host:port/<context-root>/`. In this case the path info is "/" and the servlet path and context path are the empty string ("").
- A string containing only the '/' character indicates the "default" servlet of the application. In this case, the servlet path is the request URI minus the context path and the path info is null.
- All other strings are used for exact matches only.

Servlet and resource service registrations associated with a single Servlet Context share the same namespace. In case of identical registration patterns, service ranking rules are used to select the service handling a request. That is, Whiteboard servlets that have patterns shadowed by other Whiteboard services associated with the *same* Servlet Context are represented in the failure DTOs.

The above rules can cause servlets that are already bound becoming unbound if a better match arrives. This ensures a predictable end result regardless of the order in which services are registered.

A servlet may be registered with the property `osgi.http.whiteboard.servlet.name` which can be used by servlet filters to address this servlet. If the servlet service does not have this property, the servlet name defaults to the fully qualified class name of the service object.

With implementations that both implement this specification as well as the *Http Service Specification* on page 45, situations can arise where a servlet is registered for the same pattern with the Http Service as well as with the Http Whiteboard. The Servlet Context of the Http Service is treated in the same way as all contexts managed by the Whiteboard implementation. The highest ranking is associated with the context of the Http Service. For a request, contexts are processed in the order as described in section *The Servlet Context* on page 1068.

For example, if the Http Whiteboard implementation is listening on port 80 on the machine `www.acme.com` and the Servlet object is registered with the pattern `/servlet`, then the Servlet object's `service()` method is called when the following URL is used from a web browser:

```
http://www.acme.com/servlet
```

The following table describes the properties that can be used by Servlets registered as Whiteboard services. Additionally, the common properties listed in Table 140.3 on page 1074 are supported.

Table 140.4 *Service properties for Servlet Whiteboard services.*

Service Property Name	Type	Description
<code>osgi.http.whiteboard.servlet.&lt;</code> <code>asyncSupported</code>	String <i>optional</i>	Declares whether the servlet supports the asynchronous operation mode. Allowed values are true and false independent of case. Defaults to false. See <a href="#">HTTP_WHITEBOARD_SERVLET_ASYNC_SUPPORTED</a> .
<code>osgi.http.whiteboard.servlet.&lt;</code> <code>errorPage</code>	String+ <i>optional</i>	Register the servlet as an error page for the error code and/or exception specified; the value may be a fully qualified exception type name or a three-digit HTTP status code in the range 400-599. Special values 4xx and 5xx can be used to match value ranges. Any value not being a three-digit number is assumed to be a fully qualified exception class name. See <a href="#">HTTP_WHITEBOARD_SERVLET_ERROR_PAGE</a> .
<code>osgi.http.whiteboard.servlet.&lt;</code> <code>name</code>	String <i>optional</i>	The name of the servlet. This name is used as the value of the <code>javax.servlet.ServletConfig.getServletName()</code> method and defaults to the fully qualified class name of the service object. See <a href="#">HTTP_WHITEBOARD_SERVLET_NAME</a> .

Service Property Name	Type	Description
osgi.http.whiteboard.servlet.<pattern	String+ <i>required</i>	Registration pattern(s) for the servlet. See <a href="#">HTTP_WHITEBOARD_SERVLET_PATTERN</a> .
servlet.init.*	String <i>optional</i>	Properties starting with this prefix are provided as init parameters to the <code>javax.servlet.Servlet.init()</code> method. The <code>servlet.init.</code> prefix is removed from the parameter name. See <a href="#">HTTP_WHITEBOARD_SERVLET_INIT_PARAM_PREFIX</a> .

Servlet objects are initialized by a Http Whiteboard implementation before they start serving requests. The initialization is done by calling the Servlet object's `Servlet.init(ServletConfig)` method. The `ServletConfig` parameter provides access to the initialization parameters specified when the Servlet object was registered. Once the servlet is no longer used by the Http Whiteboard implementation the `destroy()` method is called. Failure during `Servlet.init()` will prevent the servlet from being used, which is reflected using a failure DTO. In such a case the system does *not* attempt to find an alternative servlet which might be present in the system with a lower ranking.

If the service properties of the servlet Whiteboard service are modified, the `destroy()` method is called. Subsequently the servlet is re-initialized. If a Prototype Service Factory is used for the servlet this re-initialization is done on a new service object.

When multiple Http Whiteboard implementations are present all of them can potentially process the Servlet. In such situations it can be useful to associate the servlet with a specific implementation by specifying the `osgi.http.whiteboard.target` property on the Servlet service to match its `HttpServiceRuntime` service.

If more than one Http Service Runtime matches the `osgi.http.whiteboard.target` property or the property is not set, the Servlet will be processed by all the matching implementations. A Servlet service that is processed by more than one Http Whiteboard implementation will have its `init()` method called for each implementation that processes this Servlet. Similarly, the `destroy()` method is called once when the Servlet is shut down once for each implementation that processed it. As multiple `init()` and `destroy()` calls on the same Servlet instance are generally not desirable, Servlet implementations should be registered as Prototype Service Factories as defined in the *OSGi Core Release 6*. This will ensure that each Http Whiteboard implementation processing the Servlet will use a separate instance, ensuring that only one `init()` and `destroy()` call is made per Servlet object. Servlets not registered as a Prototype Service Factory may received `init()` and `destroy()` calls multiple times on the same service object.

The following example code uses Declarative Services annotations to register a servlet whiteboard service.

```
@Component(service = Servlet.class,
    scope = ServiceScope.PROTOTYPE,
    property = {
        "osgi.http.whiteboard.servlet.pattern=/myservlet",
        "servlet.init.myname=value"})
public class MyServlet extends HttpServlet {
    private String name = "<not set>";

    public void init(ServletConfig config) {
        name = config.getInitParameter("myname");
    }

    protected void doGet(HttpServletRequest req, HttpServletResponse resp)
        throws IOException {
        resp.setContentType("text/plain");
    }
}
```



```

        resp.getWriter().println("Servlet name: " + name);
    }
}

```

This example registers the servlet at: /myservlet. Requests for `http://www.acme.com/myservlet` map to the servlet, whose service method is called to process the request.

To associate the above example servlet with the example `ServletContextHelper` in *The Servlet Context* on page 1068, add the following service property:

```
osgi.http.whiteboard.context.select=(osgi.http.whiteboard.context.name=my-context)
```

This will cause the servlet to move to `http://www.acme.com/myapp/myservlet` as configured by the custom Servlet Context Handler.

### 140.4.1 Error Pages

Servlets can be used to serve Error Pages. These are invoked when an exception is thrown during processing or if a servlet uses the `sendError()` method with a status code between 400 and 599.

For a servlet service to handle error situations the service property `osgi.http.whiteboard.servlet.errorPage` must be set. This property can have multiple values, allowing a single servlet to handle a variety of error situations. Possible values are 3-digit HTTP error codes and fully qualified exception names.

Two special error code values are recognized. The special value `4xx` means every error code in the 400-499 range. The special value `5xx` means every error code in the 500-599 range. To override such wildcard error page for a specific error, register an error page with the specific error code and a higher service ranking. Error pages shadowed by other error pages are reported via the failure DTOs. A `4xx/5xx` wildcard error page is only reported in the failure DTOs if it is shadowed by another wildcard page.

Matching exceptions follows the exception hierarchy. First the most specific exception class - the actual class of the exception - is looked up. If no matching error page for the most specific exception is found, the error page for the super class of the exception is looked up and so on. The process ends by looking up an error page for the `java.lang.Throwable` class.

While not being common practice, it is possible to combine the `osgi.http.whiteboard.servlet.errorPage` and `osgi.http.whiteboard.servlet.pattern` properties. If a single servlet registration has both these registration properties it is considered both an ordinary servlet as well as an error page.

If an error or exception occurs for which an error page servlet can be matched, it is invoked to render the error page. If the error page servlet causes an error or exception while handling the request, an implementation built-in error page is returned.

For example:

```

@Component(service = Servlet.class,
           scope = ServiceScope.PROTOTYPE,
           property = {
               "osgi.http.whiteboard.servlet.errorPage=java.io.IOException",
               "osgi.http.whiteboard.servlet.errorPage=500"})
public class MyErrorServlet extends HttpServlet {
    ...
}

```

The example servlet is invoked in case of a 500 error code, or if an `IOException` (or subclass) occurs. If there is more than one error page registered for the same exception or error code, service ranking rules are used to select the handling servlet.

### 140.4.2 Asynchronous request handling

Servlets can use the asynchronous request handling feature, as defined by the servlet specification.

A servlet or servlet filter supporting the asynchronous mode must declare this with the appropriate service property `osgi.http.whiteboard.servlet.asyncSupported` or `osgi.http.whiteboard.filter.asyncSupported`.

An example simple asynchronous servlet that handles the servlet requests in a thread from a custom thread pool rather than in the thread provided by the servlet container:

```
@Component(service = Servlet.class,
    scope = ServiceScope.PROTOTYPE,
    property = {
        "osgi.http.whiteboard.servlet.pattern=/as",
        "osgi.http.whiteboard.servlet.asyncSupported=true"})
public class AsyncServlet extends HttpServlet {
    ExecutorService executor = Executors.newCachedThreadPool(
        r -> new Thread(r, "Pooled Thread"));

    protected void doGet(HttpServletRequest req, HttpServletResponse resp)
        throws IOException {
        doGetAsync(req.startAsync());
    }

    private void doGetAsync(AsyncContext asyncContext) {
        executor.submit(() -> {
            try {
                PrintWriter writer = asyncContext.getResponse().getWriter();
                writer.print("Servlet executed async in: " +
                    Thread.currentThread()); // writes 'Pooled Thread'
            } finally {
                asyncContext.complete();
            }
        });
    }
}
```

### 140.4.3 Annotations

Annotations defined in the Servlet API Specifications are ignored by an implementation of the Http Whiteboard Specification. The OSGi service model is used instead by this specification.

Implementations of this specification *may* support these annotations through a proprietary opt-in mechanism.

## 140.5 Registering Servlet Filters

Servlet filters provide a mechanism to intercept servlet invocations. They support modifying the `ServletRequest` and `ServletResponse` objects and are often used to augment web pages generated by servlets, for example with a common header or footer. Servlet filters can also be used to handle security, do logging or transform the content produced by a servlet to a certain format.

Similar to servlets, servlet filters are registered as Whiteboard services, by registering a `javax.servlet.Filter` instance in the Service Registry. The following table describes the supported ser-

vice properties. In addition the common properties as described in Table 140.3 on page 1074 are supported.

Table 140.5 *Service properties for Filter Whiteboard services.*

Service Property Name	Type	Description
osgi.http.whiteboard.filter.« asyncSupported	String <i>optional</i>	Declares whether the servlet filter supports asynchronous operation mode. Allowed values are true and false independent of case. Defaults to false. See <a href="#">HTTP_WHITEBOARD_FILTER_ASYNC_SUPPORTED</a> .
osgi.http.whiteboard.filter.« dispatcher	String+ <i>optional</i>	Select the dispatcher configuration when the servlet filter should be called. Allowed string values are REQUEST, ASYNC, ERROR, INCLUDE, and FORWARD. The default for a filter is REQUEST. See <a href="#">HTTP_WHITEBOARD_FILTER_DISPATCHER</a> .
osgi.http.whiteboard.filter.name	String <i>optional</i>	The name of a servlet filter. This name is used as the value of the <code>FilterConfig.getFilterName()</code> method and defaults to the fully qualified class name of the service object. See <a href="#">HTTP_WHITEBOARD_FILTER_NAME</a> .
osgi.http.whiteboard.filter.pattern	String+ <i>optional</i> <sup>†</sup>	Apply this servlet filter to the specified URL path patterns. The format of the patterns is specified in the servlet specification. See <a href="#">HTTP_WHITEBOARD_FILTER_PATTERN</a> .
osgi.http.whiteboard.filter.regex	String+ <i>optional</i> <sup>†</sup>	Apply this servlet filter to the specified URL paths. The paths are specified as regular expressions following the syntax defined in the <code>java.util.regex.Pattern</code> class. See <a href="#">HTTP_WHITEBOARD_FILTER_REGEX</a> .
osgi.http.whiteboard.filter.servlet	String+ <i>optional</i> <sup>†</sup>	Apply this servlet filter to the referenced servlet(s) by name. See <a href="#">HTTP_WHITEBOARD_FILTER_SERVLET</a> .
filter.init.*	String+ <i>optional</i>	Properties starting with this prefix are passed as init parameters to the <code>Filter.init()</code> method. The <code>filter.init.</code> prefix is removed from the parameter name. See <a href="#">HTTP_WHITEBOARD_FILTER_INIT_PARAM_PREFIX</a> .

<sup>†</sup> Note that at least one of the following properties *must* be specified on Filter Whiteboard services:

```
osgi.http.whiteboard.filter.pattern
osgi.http.whiteboard.filter.regex
osgi.http.whiteboard.filter.servlet
```

Similar to servlets, Filter objects are initialized by a Http Whiteboard implementation before they start filtering requests. The initialization is done by calling the `Filter.init(FilterConfig)` method. The `FilterConfig` parameter provides access to `filter.init.*` properties on the servlet filter service registration. Once the Filter is no longer used by the Http Whiteboard implementation, the `destroy()` method is called. When the service properties on the servlet filter are modified, the `destroy()` method is called and the servlet filter is subsequently re-initialized, if it can still be associated with a Http Whiteboard implementation after the modification. By default, a servlet filter can be used with any Servlet Context Helper or Http Whiteboard implementation. To restrict a servlet filter to a single implementation or a specific Servlet Context Helper, the *Common Whiteboard Properties* on page 1073 can be used.

To deal with the dynamicity of the Whiteboard service lifecycle, it is recommended to implement a servlet filter as Prototype Service Factory service. This will ensure that one single servlet filter instance only receives one `init()` and one `destroy()` call. Otherwise a single servlet filter instance can receive multiple such calls. This is similar to the behavior recommended for Servlet Whiteboard services.

Multiple servlet filters can process the same servlet request/response. If more than one Filter matches, the order in which they are processed is governed by their service ranking. The servlet filter with the highest ranking is processed first in the filter chain, while the servlet filter with the lowest ranking is processed last, before the `Servlet.service()` method is called. In the case of a service ranking tie, the servlet filter with the lowest `service.id` is processed first. After the servlet completes its `service()` method the filter chain is unwound in reverse order.

Servlet filters are only applied to servlet requests if they are bound to the same Servlet Context Helper and the same Http Whiteboard implementation.

The example Filter below adds some text before and after the content generated by a servlet:

```
@Component(scope = ServiceScope.PROTOTYPE,
    property = "osgi.http.whiteboard.filter.pattern=/*")
public class MyFilter implements Filter {
    public void init(FilterConfig filterConfig) throws ServletException {}

    public void doFilter(ServletRequest request, ServletResponse response,
        FilterChain chain) throws IOException, ServletException {
        response.getWriter().write("before");
        chain.doFilter(request, response);
        response.getWriter().write("after");
    }

    public void destroy() {}
}
```

## 140.6 Registering Resources

A resource is a file containing images, static HTML pages, JavaScript, CSS, sounds, movies, etc. Resources do not require any handling from the bundle. They are transferred directly from their source - usually the JAR file that contains the code for the bundle - to the requester.

Resources can be served by registering a service of any type with a service registration property that marks it as a resource service: `osgi.http.whiteboard.resource.pattern`. The actual service object registered is not used to serve resources, it is merely used to inform the Http Whiteboard implementation to serve resources from a certain source.

The following table describes the supported service properties. In addition the common properties as described in Table 140.3 on page 1074 are supported.

Table 140.6 *Service properties for resource services.*

Service Property Name	Type	Description
<code>osgi.http.whiteboard.resource.&lt;&lt;pattern</code>	String+ <i>required</i>	The pattern(s) to be used to serve resources. As defined by the [4] <i>Java Servlet 3.1 Specification</i> in section 12.2, <i>Specification of Mappings</i> .  This property marks the service as a resource service.  See <a href="#">HTTP_WHITEBOARD_RESOURCE_PATTERN</a> .

Service Property Name	Type	Description
osgi.http.whiteboard.resource.<prefix	String <i>required</i>	The prefix used to map a requested resource to the bundle's entries. If the request's path info is not null, it is appended to this prefix. The resulting string is passed to the <a href="#">getResource(String)</a> method of the associated Servlet Context Helper.  See <a href="#">HTTP_WHITEBOARD_RESOURCE_PREFIX</a> .

The examples below use Declarative Services annotations to register a resources service. Note that this service is purely used to convey information to the Http Whiteboard implementation and is never invoked.

```
@Component(service = MyResourceService.class,
    property = {
        "osgi.http.whiteboard.resource.pattern=/files/*",
        "osgi.http.whiteboard.resource.prefix=/www"})
public class MyResourceService {}
```

A Http Whiteboard implementation configured on port 80 will serve a request for `http://localhost/files/cheese.html` from the location `/www/cheese.html`.

The following example maps requests for `/favicon.ico` to serve the `/logo.png` resource. Note that the pattern is not appended to the prefix as the path info in this case is null.

```
@Component(service = SomeResourceService.class,
    property = {
        "osgi.http.whiteboard.resource.pattern=/favicon.ico",
        "osgi.http.whiteboard.resource.prefix=/logo.png"})
public class SomeResourceService {}
```

The above examples use the default `ServletContextHelper` implementation, which loads these resources from the bundle that registered the resource service. For more control around serving resources, a resources service can be associated to a custom `ServletContextHelper`. For example, a custom Servlet Context Helper can serve resources from locations other than the current bundle.

### 140.6.1 Overlapping Resource and Servlet registrations

Resources and servlets registered with the same Servlet Context share a single URI namespace. This means that the value specified in `osgi.http.whiteboard.resource.pattern` competes with the `osgi.http.whiteboard.servlet.pattern` property specified on servlets. If these values overlap, the rules as outlined in *Registering Servlets* on page 1074 are used to resolve conflicts, where resource services are treated just like servlets. Shadowed resource patterns are reported as [FailedResourceDTO](#).

## 140.7 Registering Listeners

The servlet specification defines listener interfaces that can be implemented to receive a variety of servlet-related events. When using the Http Whiteboard implementation these listeners can be registered as Whiteboard services.

- `ServletContextListener` - Receive notifications when Servlet Contexts are initialized and destroyed.
- `ServletContextAttributeListener` - Receive notifications for Servlet Context attribute changes.
- `ServletRequestListener` - Receive notifications for servlet requests coming in and being destroyed.

- `ServletRequestAttributeListener` - Receive notifications when servlet Request attributes change.
- `HttpSessionListener` - Receive notifications when Http Sessions are created or destroyed.
- `HttpSessionAttributeListener` - Receive notifications when Http Session attributes change.
- `HttpSessionIdListener` - Receive notifications when Http Session ID changes.

Events are sent to listeners registered in the Service Registry with the `osgi.http.whiteboard.listener` service property set to true, independent of case. Listeners can be associated with a `ServletContextHelper` as described in *Common Whiteboard Properties* on page 1073. Listeners not specifically associated with a Servlet Context Helper will receive events relating to the *default* Servlet Context Helper.

Multiple listeners of the same type registered with a given Servlet Context Helper are invoked in sequence, service ranking rules are used to determine the order.

Table 140.7

*Service properties for listener services.*

Service Property Name	Type	Description
<code>osgi.http.whiteboard.listener</code>	String <i>required</i>	When set to true this listener service is handled by the Http Whiteboard implementation. When not set or set to false the service is ignored. Any other value is invalid and will be reflected in a <code>FailedListenerDTO</code> . Note the property value is case independent. See <a href="#">HTTP_WHITEBOARD_LISTENER</a> .

An example listener that reports on client requests being initialized and destroyed is listed below:

```
@Component(property = "osgi.http.whiteboard.listener=true")
public class MyServletRequestListener implements ServletRequestListener {
    public void requestInitialized(ServletRequestEvent sre) {
        System.out.println("Request initialized for client: " +
            sre.getServletRequest().getRemoteAddr());
    }

    public void requestDestroyed(ServletRequestEvent sre) {
        System.out.println("Request destroyed for client: " +
            sre.getServletRequest().getRemoteAddr());
    }
}
```

For more details on the behavior of the listeners see the [4] *Java Servlet 3.1 Specification*.

## 140.8 Lifecycle

If a Whiteboard service is used by a Http Whiteboard implementation, the following order of actions are performed:

1. The service is obtained from the service registry.
2. For servlets and servlet filters, `init()` is called.

When the service is not used anymore, these actions are performed:

3. For servlets and servlet filters, `destroy()` is called.
4. The service is released.

Note that some of the above actions may not be performed immediately, allowing an implementation to utilize lazy or asynchronous behavior.

As servlets and servlet filters services might come and go as well as ServletContextHelper services might come and go, use of the Whiteboard services can be very dynamic. Therefore servlet and servlet filter services might transition between bound to a Http Whiteboard implementation to being unbound and back to be bound. For example, when a matching Servlet Context Helper with the same name arrives with a higher ranking than the currently bound Servlet Context Helper, the servlet will be destroyed and re-initialized, bound to this better matching Servlet Context Helper. This is to ensure that timing issues cannot dictate the topology of the system.

As `init()` and `destroy()` are called each time the service life cycle changes, the recommended way to register services is to use the Prototype Service scope as defined in the *OSGi Core Release 6*. This ensures a new instance is created for each time such service is re-initialized. If the prototype scope is not used, the service should be prepared that after a call to `destroy()` a new initialization through `init()` might follow.

### 140.8.1 Whiteboard Service Dynamics and Active Requests

When the Http Whiteboard implementation receives a network request it establishes the processing pipeline based on the available Whiteboard services (servlets, servlet filters and resource services) and executes this pipeline. Between establishing the pipeline and finishing the processing, services used in this pipeline might become unregistered. It is up to the Http Whiteboard implementation whether it completes the active request or throws a Servlet Exception in this case.

## 140.9 The Http Service Runtime Service

The [HttpServiceRuntime](#) service represents the runtime state information of a Http Whiteboard implementation. This information is provided through Data Transfer Objects (DTOs). The architecture of OSGi DTOs is described in *OSGi Core Release 6*.

Each Http Whiteboard implementation registers exactly one `HttpServiceRuntime` service which can be used to target Whiteboard services defined in this specification to a specific Http Whiteboard implementation.

Implementations of this specification that also implement the *Http Service Specification* on page 45 can provide runtime information for servlets registered using the `HttpService` via the `HttpServiceRuntime` as well. In this case the `osgi.http.service.id` service property must be set to associate the `HttpServiceRuntime` service with the `HttpService`.

The `HttpServiceRuntime` provides service registration properties to declare its underlying Http Whiteboard implementation. These service properties can include implementation-specific key-value pairs. They also include the following:

Table 140.8 Service properties for the `HttpServiceRuntime` service

Service Property Name	Type	Description
<code>osgi.http.endpoint</code>	<code>String+</code>	Endpoint(s) where this Http Whiteboard implementation is listening. Registered Whiteboard services are made available here. Values could be provided as URLs e.g. <code>http://192.168.1.10:8080/</code> or relative paths, e.g. <code>/myapp/</code> . Relative paths may be used if the scheme and authority parts of the URLs are not known such as in a bridged Http Service implementation. If the Http Service is serving the root context and scheme and authority are not known, the value of the property is <code>/</code> . Each entry must end with a slash.  See <a href="#">HTTP_SERVICE_ENDPOINT</a> .

Service Property Name	Type	Description
osgi.http.service.id	Collection<Long>	If this Http Whiteboard implementation also implements the <i>Http Service Specification</i> on page 45, this property is set to hold the service.id values of all the HttpService services provided by this implementation.  See <a href="#">HTTP_SERVICE_ID</a> .

The Http Service Runtime service provides information on registered Whiteboard services through the [RuntimeDTO](#) and [RequestInfoDTO](#). The [RuntimeDTO](#) provides information on services that have been successfully registered as well as information about the Whiteboard services that were not successfully registered. Whiteboard services that have the required properties set but cannot be processed, are reflected in the failure DTOs. Whiteboard services of interfaces described in this specification that do not have the required properties set are ignored and not reflected in the failure DTOs.

The Runtime DTO can be obtained using the [getRuntimeDTO\(\)](#) method. The Runtime DTO provided has the following structure:

Figure 140.3 Runtime DTO Overview Diagram

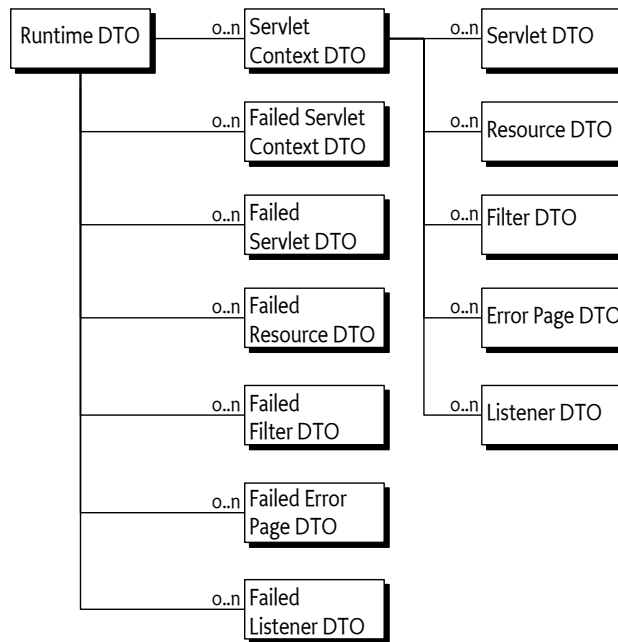

Handlers for a given request path can be found with the [calculateRequestInfoDTO\(String\)](#) method. This method returns a [RequestInfoDTO](#) with the following structure:



Figure 140.4 Request Info DTO Overview Diagram

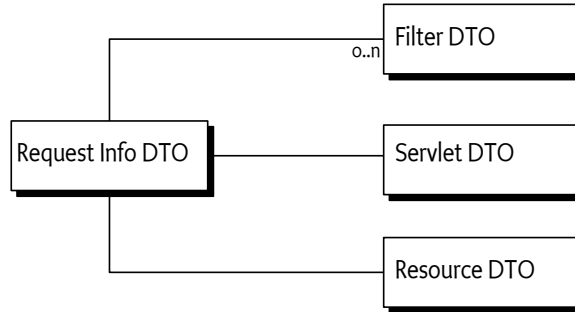

Where servlets registered via the *Http Service Specification* on page 45 are returned via this service, the Servlet DTO will report negative service IDs for these servlets to distinguish them from Servlet Whiteboard services.

## 140.10 Configuration Properties

If the Http Whiteboard implementation does not have its port values configured through some other means, the implementation should use the following Framework properties to determine the port values to listen on.

- `org.osgi.service.http.port` - This property specifies the port used for servlets and resources accessible via HTTP. The default value for this property is 80.
- `org.osgi.service.http.port.secure` - This property specifies the port used for servlets and resources accessible via HTTPS. The default value for this property is 443.

## 140.11 Capabilities

### 140.11.1 `osgi.implementation` Capability

The Http Whiteboard implementation bundle must provide the `osgi.implementation` capability with name `osgi.http`. This capability can be used by provisioning tools and during resolution to ensure that a Http Whiteboard implementation is present to process the Whiteboard services defined in this specification. The capability must also declare a `uses` constraint for the Servlet and OSGi Http Whiteboard packages and provide the version of this specification:

```

Provide-Capability: osgi.implementation;
                    osgi.implementation="osgi.http";
                    uses:="javax.servlet, javax.servlet.http,
                        org.osgi.service.http.context, org.osgi.service.http.whiteboard";
                    version:Version="1.0"
  
```

This capability must follow the rules defined for the *osgi.implementation Namespace* on page 997.

### 140.11.2 `osgi.contract` Capability

The Http Whiteboard implementation must provide a capability in the `osgi.contract` namespace with name `javaServlet` if it exports the `javax.servlet` and `javax.servlet.http` packages. See [5] *Portable Java Contract Definitions*.

Providing the `osgi.contract` capability enables developer to build portable bundles for packages that are not versioned under OSGi Semantic Versioning rules. For more details see *osgi.contract Namespace* on page 995.

If the Servlet API is provided by another bundle, the Http Whiteboard implementation should be a consumer of the API and require the contract.

### 140.11.3 **osgi.service Capability**

The bundle providing the `HttpServiceRuntime` service must provide a capability in the `osgi.service` namespace representing this service. This capability must also declare a uses constraint for the `org.osgi.service.http.runtime` and `org.osgi.service.http.runtime.dto` packages:

```
Provide-Capability: osgi.service;
  objectClass:List<String>="org.osgi.service.http.runtime.HttpServiceRuntime";
  uses:="org.osgi.service.http.runtime,org.osgi.service.http.runtime.dto"
```

This capability must follow the rules defined for the *osgi.service Namespace* on page 997.

## 140.12 **Security**

This section only applies when executing in an OSGi environment which is enforcing Java permissions.

### 140.12.1 **Service Permissions**

Bundles that need to register Http Whiteboard services must be granted `ServicePermission[interfaceName, REGISTER]` where interface name is the Http Whiteboard service interface name.

The Http Whiteboard implementation must be granted `ServicePermission[interfaceName, GET]` to retrieve the Http Whiteboard services from the service registry.

### 140.12.2 **Introspection**

Bundles that need to introspect the state of the Http runtime will need `ServicePermission[org.osgi.service.http.runtime.HttpServiceRuntime, GET]` to obtain the `HttpServiceRuntime` service and access the DTO types.

### 140.12.3 **Accessing Resources with the Default Servlet Context Helper Implementation**

The Http Whiteboard implementation must be granted `AdminPermission[* ,RESOURCE]` so that bundles may use the default `ServletContextHelper` implementation. This is necessary because the implementation of the default `ServletContextHelper` must call `Bundle.getEntry` to access the resources of a bundle and this method requires the caller to have `AdminPermission[bundle,RESOURCE]`.

Any bundle may access resources in its own bundle by calling `Class.getResource`. This operation is privileged. The resulting URL object may then be passed to the Http Whiteboard implementation as the result of a `ServletContextHelper.getResource` call. No further permission checks are performed when accessing bundle entry or resource URL objects, so the Http Whiteboard implementation does not need to be granted any additional permissions.

### 140.12.4 **Accessing Other Types of Resources**

In order to access resources that were not returned from the default `ServletContextHelper` implementation, the Http Whiteboard implementation must be granted sufficient privileges to access

these resources. For example, if the `getResource` method of a `ServletContextHelper` service returns a file URL, the Http Whiteboard implementation requires the corresponding `FilePermission` to read the file. Similarly, if the `getResource` method of a `ServletContextHelper` service returns an HTTP URL, the Http Whiteboard implementation requires the corresponding `SocketPermission` to connect to the resource.

Therefore, in most cases, the Http Whiteboard implementation should be a privileged service that is granted sufficient permission to serve any bundle's resources, no matter where these resources are located. Therefore, the Http Whiteboard implementation must capture the `AccessControlContext` object of the bundle registering a `ServletContextHelper` service, and then use the captured `AccessControlContext` object when accessing resources returned by the `ServletContextHelper` service. This situation prevents a bundle from supplying resources that it does not have permission to access.

Therefore, the Http Whiteboard implementation should follow a scheme like the following example. When using a `ServletContextHelper` service, it should capture the context.

```
ServiceReference<ServletContextHelper> servletContextHelperReference = ...
AccessControlContext acc = servletContextHelperReference.getBundle()
    .adapt(AccessControlContext.class);
```

When a URL returned by the `getResource` method of a `ServletContextHelper` service is used by the Http Whiteboard implementation, the implementation must use the URL in a `doPrivileged` construct using the `AccessControlContext` object of the registering bundle:

```
AccessController.doPrivileged(
    new PrivilegedExceptionAction() {
        public Object run() throws Exception {
            ...
        }
    }, acc);
```

This ensures the Http Whiteboard implementation can only use the URL if the bundle registering the `ServletContextHelper` service that returned the URL also has permission to use the URL. The use of a captured `AccessControlContext` only applies when accessing URL objects returned by the `getResource` method of the `ServletContextHelper` service.

### 140.12.5 Calling Http Whiteboard Services

This specification does not require that the Http Whiteboard implementation is granted All Permission or wraps calls to the Http Whiteboard services in a `doPrivileged` block. Therefore, it is the responsibility of the Http Whiteboard service implementations to use a `doPrivileged` block when performing privileged operations.

## 140.13 org.osgi.service.http.context

Http Whiteboard Context Package Version 1.0.

Bundles wishing to use this package must list the package in the `Import-Package` header of the bundle's manifest. This package has two types of users: the consumers that use the API in this package and the providers that implement the API in this package.

Example import for consumers using the API in this package:

```
Import-Package: org.osgi.service.http.context; version="[1.0,2.0]"
```

Example import for providers implementing the API in this package:

---

```
Import-Package: org.osgi.service.http.context; version="[1.0,1.1]"
```

### 140.13.1 Summary

- ServletContextHelper - Helper service for a servlet context used by a Http Whiteboard implementation to serve HTTP requests.

### 140.13.2 public abstract class ServletContextHelper

Helper service for a servlet context used by a Http Whiteboard implementation to serve HTTP requests.

This service defines methods that the Http Whiteboard implementation may call to get information for a request when dealing with whiteboard services.

Each ServletContextHelper is registered with a "osgi.http.whiteboard.context.name" service property containing a name to reference by servlets, servlet filters, resources, and listeners. If there is more than one ServletContextHelper registered with the same context name, the one with the highest service ranking is active, the others are inactive.

A context is registered with the "osgi.http.whiteboard.context.path" service property to define a path under which all services registered with this context are reachable. If there is more than one ServletContextHelper registered with the same path, each duplicate context path is searched by service ranking order according to `org.osgi.framework.ServiceReference.compareTo(Object)` until a matching servlet or resource is found.

Servlets, servlet filters, resources, and listeners services may be associated with a ServletContextHelper service with the "osgi.http.whiteboard.context.select" service property. If the referenced ServletContextHelper service does not exist or is currently not active, the whiteboard services for that ServletContextHelper are not active either.

If no ServletContextHelper service is associated, that is no "osgi.http.whiteboard.context.select" service property is configured for a whiteboard service, a default ServletContextHelper is used.

Those whiteboard services that are associated with the same ServletContextHelper object will share the same ServletContext object.

The behavior of the methods on the default ServletContextHelper is defined as follows:

- `getMimeType` - Always returns null.
- `handleSecurity` - Always returns true.
- `getResource` - Assumes the named resource is in the bundle of the whiteboard service, addressed from the root. This method calls the whiteboard service bundle's `Bundle.getEntry` method, and returns the appropriate URL to access the resource. On a Java runtime environment that supports permissions, the Http Whiteboard implementation needs to be granted `org.osgi.framework.AdminPermission[*],RESOURCE`.
- `getResourcePaths` - Assumes that the resources are in the bundle of the whiteboard service. This method calls `Bundle.findEntries` method, and returns the found entries. On a Java runtime environment that supports permissions, the Http Whiteboard implementation needs to be granted `org.osgi.framework.AdminPermission[*],RESOURCE`.
- `getRealPath` - Always returns null.

*See Also* `HttpWhiteboardConstants.HTTP_WHITEBOARD_CONTEXT_NAME`,  
`HttpWhiteboardConstants.HTTP_WHITEBOARD_CONTEXT_PATH`

*Concurrency* Thread-safe

#### 140.13.2.1 public static final String AUTHENTICATION\_TYPE = "org.osgi.service.http.authentication.type"

HttpServletRequest attribute specifying the scheme used in authentication. The value of the attribute can be retrieved by `HttpServletRequest.getAuthType`.

**140.13.2.2 public static final String AUTHORIZATION = "org.osgi.service.useradmin.authorization"**

HttpServletRequest attribute specifying the Authorization object obtained from the org.osgi.service.useradmin.UserAdmin service. The value of the attribute can be retrieved by HttpServletRequest.getAttribute(ServletContextHelper.AUTHORIZATION).

**140.13.2.3 public static final String REMOTE\_USER = "org.osgi.service.http.authentication.remote.user"**

HttpServletRequest attribute specifying the name of the authenticated user. The value of the attribute can be retrieved by HttpServletRequest.getRemoteUser.

**140.13.2.4 public ServletContextHelper()**

- Construct a new context helper.

If needed, the subclass will have to handle the association with a specific bundle.

**140.13.2.5 public ServletContextHelper(Bundle bundle)**

*bundle* The bundle to be associated with this context helper.

- Construct a new context helper associated with the specified bundle.

**140.13.2.6 public String getMimeType(String name)**

*name* The name for which to determine the MIME type.

- Maps a name to a MIME type.

Called by the Http Whiteboard implementation to determine the MIME type for the specified name. For whiteboard services, the Http Whiteboard implementation will call this method to support the ServletContext method getMimeType. For resource servlets, the Http Whiteboard implementation will call this method to determine the MIME type for the Content-Type header in the response.

*Returns* The MIME type (e.g. text/html) of the specified name or null to indicate that the Http Whiteboard implementation should determine the MIME type itself.

**140.13.2.7 public String getRealPath(String path)**

*path* The virtual path to be translated to a real path.

- Gets the real path corresponding to the given virtual path.

Called by the Http Whiteboard implementation to support the ServletContext method getRealPath for whiteboard services.

*Returns* The real path, or null if the translation cannot be performed.

**140.13.2.8 public URL getResource(String name)**

*name* The name of the requested resource.

- Maps a resource name to a URL.

Called by the Http Whiteboard implementation to map the specified resource name to a URL. For servlets, the Http Whiteboard implementation will call this method to support the ServletContext methods getResource and getResourceAsStream. For resources, the Http Whiteboard implementation will call this method to locate the named resource.

The context can control from where resources come. For example, the resource can be mapped to a file in the bundle's persistent storage area via BundleContext.getDataFile(name).toURI().toURL() or to a resource in the context's bundle via getClass().getResource(name)

*Returns* A URL that a Http Whiteboard implementation can use to read the resource or null if the resource does not exist.

**140.13.2.9 public Set<String> getResourcePaths(String path)**

*path* The partial path used to match the resources, which must start with a /.

- Returns a directory-like listing of all the paths to resources within the web application whose longest sub-path matches the supplied path argument.

Called by the Http Whiteboard implementation to support the ServletContext method `getResourcePaths` for whiteboard services.

*Returns* A Set containing the directory listing, or null if there are no resources in the web application whose path begins with the supplied path.

**140.13.2.10 public boolean handleSecurity(HttpServletRequest request, HttpServletResponse response) throws IOException**

*request* The HTTP request.

*response* The HTTP response.

- Handles security for the specified request.

The Http Whiteboard implementation calls this method prior to servicing the specified request. This method controls whether the request is processed in the normal manner or an error is returned.

If the request requires authentication and the Authorization header in the request is missing or not acceptable, then this method should set the WWW-Authenticate header in the response object, set the status in the response object to Unauthorized(401) and return false. See also RFC 2617: HTTP Authentication: Basic and Digest Access Authentication [<http://www.ietf.org/rfc/rfc2617.txt>].

If the request requires a secure connection and the `getScheme` method in the request does not return 'https' or some other acceptable secure protocol, then this method should set the status in the response object to Forbidden(403) and return false.

When this method returns false, the Http Whiteboard implementation will send the response back to the client, thereby completing the request. When this method returns true, the Http Whiteboard implementation will proceed with servicing the request.

If the specified request has been authenticated, this method must set the AUTHENTICATION\_TYPE request attribute to the type of authentication used, and the REMOTE\_USER request attribute to the remote user (request attributes are set using the `setAttribute` method on the request). If this method does not perform any authentication, it must not set these attributes.

If the authenticated user is also authorized to access certain resources, this method must set the AUTHORIZATION request attribute to the Authorization object obtained from the `org.osgi.service.useradmin.UserAdmin` service.

The servlet responsible for servicing the specified request determines the authentication type and remote user by calling the `getAuthType` and `getRemoteUser` methods, respectively, on the request.

*Returns* true if the request should be serviced, false if the request should not be serviced and Http Whiteboard implementation will send the response back to the client.

*Throws* IOException– May be thrown by this method. If this occurs, the Http Whiteboard implementation will terminate the request and close the socket.

## 140.14 org.osgi.service.http.runtime

Http Runtime Package Version 1.0.

Bundles wishing to use this package must list the package in the Import-Package header of the bundle's manifest. This package has two types of users: the consumers that use the API in this package and the providers that implement the API in this package.

Example import for consumers using the API in this package:

```
Import-Package: org.osgi.service.http.runtime; version="[1.0,2.0]"
```

Example import for providers implementing the API in this package:

```
Import-Package: org.osgi.service.http.runtime; version="[1.0,1.1]"
```

### 140.14.1 Summary

- `HttpServiceRuntime` - The `HttpServiceRuntime` service represents the runtime information of an Http Whiteboard implementation.
- `HttpServiceRuntimeConstants` - Defines standard names for Http Runtime Service constants.

### 140.14.2 public interface `HttpServiceRuntime`

The `HttpServiceRuntime` service represents the runtime information of an Http Whiteboard implementation.

It provides access to DTOs representing the current state of the service.

The `HttpServiceRuntime` service must be registered with the `HttpServiceRuntimeConstants.HTTP_SERVICE_ENDPOINT` service property.

*Concurrency* Thread-safe

*Provider Type* Consumers of this API must not implement this type

#### 140.14.2.1 public `RequestInfoDTO calculateRequestInfoDTO(String path)`

*path* The request path, relative to the root of the Http Whiteboard implementation.

- Return a request info DTO containing the services involved with processing a request for the specified path.

*Returns* The request info DTO for the specified path.

#### 140.14.2.2 public `RuntimeDTO getRuntimeDTO()`

- Return the runtime DTO representing the current state.

*Returns* The runtime DTO.

### 140.14.3 public final class `HttpServiceRuntimeConstants`

Defines standard names for Http Runtime Service constants.

#### 140.14.3.1 public static final `String HTTP_SERVICE_ENDPOINT = "osgi.http.endpoint"`

Http Runtime Service service property specifying the endpoints upon which the Http Whiteboard implementation is listening.

An endpoint value is a URL or a relative path, to which the Http Whiteboard implementation is listening. For example, `http://192.168.1.10:8080/` or `/myapp/`. A relative path may be used if the scheme and authority parts of the URL are not known, e.g. in a bridged Http Whiteboard implementation. If the Http Whiteboard implementation is serving the root context and neither scheme nor authority is known, the value of the property is `"/`. Both, a URL and a relative path, must end with a slash.

An Http Whiteboard implementation can be listening on multiple endpoints.

The value of this service property must be of type `String`, `String[]`, or `Collection<String>`.

**140.14.3.2 public static final String HTTP\_SERVICE\_ID = "osgi.http.service.id"**

Http Runtime Service service property to associate the Http Runtime Service with one or more HttpService services.

If this Http Whiteboard implementation also implements the Http Service Specification, this service property is set to a collection of service.id for the HttpService services registered by this implementation.

The value of this service property must be of type Collection<Long>.

**140.15 org.osgi.service.http.runtime.dto**

Http Runtime DTO Package Version 1.0.

Bundles wishing to use this package must list the package in the Import-Package header of the bundle's manifest. This package has two types of users: the consumers that use the API in this package and the providers that implement the API in this package.

Example import for consumers using the API in this package:

```
Import-Package: org.osgi.service.http.runtime.dto; version="[1.0,2.0)"
```

Example import for providers implementing the API in this package:

```
Import-Package: org.osgi.service.http.runtime.dto; version="[1.0,1.1)"
```

**140.15.1 Summary**

- BaseServletDTO - Represents common information about a javax.servlet.Servlet service.
- DTOConstants - Defines standard constants for the DTOs.
- ErrorPageDTO - Represents a javax.servlet.Servlet for handling errors and currently being used by a servlet context.
- FailedErrorPageDTO - Represents a javax.servlet.Servlet service registered as an error page but currently not being used by a servlet context due to a problem.
- FailedFilterDTO - Represents a servlet Filter service which is currently not being used by a servlet context due to a problem.
- FailedListenerDTO - Represents a listener service which is currently not being used by a servlet context due to a problem.
- FailedResourceDTO - Represents a resource definition which is currently not being used by a servlet context due to a problem.
- FailedServletContextDTO - Represents a servlet context that is currently not used due to some problem.
- FailedServletDTO - Represents a javax.servlet.Servlet service which is currently not being used by a servlet context due to a problem.
- FilterDTO - Represents a servlet javax.servlet.Filter service currently being used for by a servlet context.
- ListenerDTO - Represents a listener currently being used by a servlet context.
- RequestInfoDTO - Represents the services used to process a specific request.
- ResourceDTO - Represents a resource definition currently being used by a servlet context.
- RuntimeDTO - Represents the state of a Http Service Runtime.
- ServletContextDTO - Represents a javax.servlet.ServletContext created for servlets, resources, servlet Filters, and listeners associated with that servlet context.
- ServletDTO - Represents a javax.servlet.Servlet currently being used by a servlet context.



## 140.15.2 **public abstract class BaseServletDTO** **extends DTO**

Represents common information about a `javax.servlet.Servlet` service.

*Concurrency* Not Thread-safe

### 140.15.2.1 **public boolean asyncSupported**

Specifies whether the servlet supports asynchronous processing.

### 140.15.2.2 **public Map<String,String> initParams**

The servlet initialization parameters as provided during registration of the servlet. Additional parameters like the Http Service Runtime attributes are not included. If the service has no initialization parameters, the map is empty.

### 140.15.2.3 **public String name**

The name of the servlet. This value is never null.

### 140.15.2.4 **public long serviceId**

Service property identifying the servlet. In the case of a servlet registered in the service registry and picked up by a Http Whiteboard Implementation, this value is not negative and corresponds to the service id in the registry. If the servlet has not been registered in the service registry, the value is negative and a unique negative value is generated by the Http Service Runtime in this case.

### 140.15.2.5 **public long servletContextId**

The service id of the servlet context for the servlet represented by this DTO.

### 140.15.2.6 **public String servletInfo**

The information string from the servlet.

This is the value returned by the `Servlet.getServletInfo()` method.

### 140.15.2.7 **public BaseServletDTO()**

## 140.15.3 **public final class DTOConstants**

Defines standard constants for the DTOs.

### 140.15.3.1 **public static final int FAILURE\_REASON\_EXCEPTION\_ON\_INIT = 4**

An exception occurred during initializing of the service.

This reason can only happen for servlets and servlet filters.

### 140.15.3.2 **public static final int FAILURE\_REASON\_NO\_SERVLET\_CONTEXT\_MATCHING = 1**

No matching `ServletContextHelper`.

### 140.15.3.3 **public static final int FAILURE\_REASON\_SERVICE\_IN\_USE = 7**

The service is not registered as a prototype scoped service and is already in use with a servlet context and therefore can't be used with another servlet context.

### 140.15.3.4 **public static final int FAILURE\_REASON\_SERVICE\_NOT\_GETTABLE = 5**

The service is registered in the service registry but getting the service fails as it returns null.

### 140.15.3.5 **public static final int FAILURE\_REASON\_SERVLET\_CONTEXT\_FAILURE = 2**

Matching `ServletContextHelper`, but the context is not used due to a problem with the context.

**140.15.3.6**      **public static final int FAILURE\_REASON\_SHADOWED\_BY\_OTHER\_SERVICE = 3**

Service is shadowed by another service.

For example, a service with the same service properties but a higher service ranking.

**140.15.3.7**      **public static final int FAILURE\_REASON\_UNKNOWN = 0**

Failure reason is unknown.

**140.15.3.8**      **public static final int FAILURE\_REASON\_VALIDATION\_FAILED = 6**

The service is registered in the service registry but the service properties are invalid.

**140.15.4**      **public class ErrorPageDTO**  
**extends BaseServletDTO**

Represents a javax.servlet.Servlet for handling errors and currently being used by a servlet context.

*Concurrency* Not Thread-safe

**140.15.4.1**      **public long[] errorCodes**

The error codes the error page is used for. This array might be empty.

**140.15.4.2**      **public String[] exceptions**

The exceptions the error page is used for. This array might be empty.

**140.15.4.3**      **public ErrorPageDTO()**

**140.15.5**      **public class FailedErrorPageDTO**  
**extends ErrorPageDTO**

Represents a javax.servlet.Servlet service registered as an error page but currently not being used by a servlet context due to a problem.

As the servlet represented by this DTO is not used due to a failure, the field FailedErrorPageDTO.servletContextId always returns 0 and does not point to an existing Servlet-ContextHelper.

*Concurrency* Not Thread-safe

**140.15.5.1**      **public int failureReason**

The reason why the servlet represented by this DTO is not used.

*See Also* DTOConstants.FAILURE\_REASON\_UNKNOWN,  
DTOConstants.FAILURE\_REASON\_EXCEPTION\_ON\_INIT,  
DTOConstants.FAILURE\_REASON\_NO\_SERVLET\_CONTEXT\_MATCHING,  
DTOConstants.FAILURE\_REASON\_SERVICE\_NOT\_GETTABLE,  
DTOConstants.FAILURE\_REASON\_SERVLET\_CONTEXT\_FAILURE,  
DTOConstants.FAILURE\_REASON\_SHADOWED\_BY\_OTHER\_SERVICE

**140.15.5.2**      **public FailedErrorPageDTO()**

**140.15.6**      **public class FailedFilterDTO**  
**extends FilterDTO**

Represents a servlet Filter service which is currently not being used by a servlet context due to a problem.

As the service represented by this DTO is not used due to a failure, the field `FailedFilterDTO.servletContextId` always returns 0 and does not point to an existing servlet context.

*Concurrency* Not Thread-safe

#### 140.15.6.1 **public int failureReason**

The reason why the servlet filter represented by this DTO is not used.

*See Also* `DTOConstants.FAILURE_REASON_UNKNOWN`,  
`DTOConstants.FAILURE_REASON_EXCEPTION_ON_INIT`,  
`DTOConstants.FAILURE_REASON_NO_SERVLET_CONTEXT_MATCHING`,  
`DTOConstants.FAILURE_REASON_SERVICE_NOT_GETTABLE`,  
`DTOConstants.FAILURE_REASON_SERVLET_CONTEXT_FAILURE`,  
`DTOConstants.FAILURE_REASON_SHADOWED_BY_OTHER_SERVICE`

#### 140.15.6.2 **public FailedFilterDTO()**

### 140.15.7 **public class FailedListenerDTO** **extends ListenerDTO**

Represents a listener service which is currently not being used by a servlet context due to a problem.

As the listener represented by this DTO is not used due to a failure, the field `FailedErrorPageDTO.servletContextId` always returns 0 and does not point to an existing servlet context.

*Concurrency* Not Thread-safe

#### 140.15.7.1 **public int failureReason**

The reason why the listener represented by this DTO is not used.

*See Also* `DTOConstants.FAILURE_REASON_UNKNOWN`,  
`DTOConstants.FAILURE_REASON_EXCEPTION_ON_INIT`,  
`DTOConstants.FAILURE_REASON_NO_SERVLET_CONTEXT_MATCHING`,  
`DTOConstants.FAILURE_REASON_SERVICE_NOT_GETTABLE`,  
`DTOConstants.FAILURE_REASON_SERVLET_CONTEXT_FAILURE`,  
`DTOConstants.FAILURE_REASON_SHADOWED_BY_OTHER_SERVICE`

#### 140.15.7.2 **public FailedListenerDTO()**

### 140.15.8 **public class FailedResourceDTO** **extends ResourceDTO**

Represents a resource definition which is currently not being used by a servlet context due to a problem.

As the resource represented by this DTO is not used due to a failure, the field `FailedResourceDTO.servletContextId` always returns 0 and does not point to an existing servlet context.

*Concurrency* Not Thread-safe

#### 140.15.8.1 **public int failureReason**

The reason why the resource represented by this DTO is not used.

*See Also* `DTOConstants.FAILURE_REASON_UNKNOWN`,  
`DTOConstants.FAILURE_REASON_EXCEPTION_ON_INIT`,  
`DTOConstants.FAILURE_REASON_NO_SERVLET_CONTEXT_MATCHING`,  
`DTOConstants.FAILURE_REASON_SERVICE_NOT_GETTABLE`,

DTOConstants.FAILURE\_REASON\_SERVLET\_CONTEXT\_FAILURE,  
 DTOConstants.FAILURE\_REASON\_SHADOWED\_BY\_OTHER\_SERVICE

**140.15.8.2**      **public FailedResourceDTO()**

**140.15.9**      **public class FailedServletContextDTO**  
**extends ServletContextDTO**

Represents a servlet context that is currently not used due to some problem. The following fields return an empty array for a FailedServletContextDTO:

- ServletContextDTO.servletDTOs
- ServletContextDTO.resourceDTOs
- ServletContextDTO.filterDTOs
- ServletContextDTO.errorPageDTOs
- ServletContextDTO.listenerDTOs

The method ServletContextDTO.attributes returns an empty map for a FailedServletContextDTO.

*Concurrency* Not Thread-safe

**140.15.9.1**      **public int failureReason**

The reason why the servlet context represented by this DTO is not used.

*See Also* DTOConstants.FAILURE\_REASON\_UNKNOWN,  
 DTOConstants.FAILURE\_REASON\_EXCEPTION\_ON\_INIT,  
 DTOConstants.FAILURE\_REASON\_NO\_SERVLET\_CONTEXT\_MATCHING,  
 DTOConstants.FAILURE\_REASON\_SERVICE\_NOT\_GETTABLE,  
 DTOConstants.FAILURE\_REASON\_SERVLET\_CONTEXT\_FAILURE,  
 DTOConstants.FAILURE\_REASON\_SHADOWED\_BY\_OTHER\_SERVICE

**140.15.9.2**      **public FailedServletContextDTO()**

**140.15.10**      **public class FailedServletDTO**  
**extends ServletDTO**

Represents a javax.servlet.Servlet service which is currently not being used by a servlet context due to a problem.

As the servlet represented by this DTO is not used due to a failure, the field FailedErrorPageDTO.servletContextId always returns 0 and does not point to an existing servlet context.

*Concurrency* Not Thread-safe

**140.15.10.1**      **public int failureReason**

The reason why the servlet represented by this DTO is not used.

*See Also* DTOConstants.FAILURE\_REASON\_UNKNOWN,  
 DTOConstants.FAILURE\_REASON\_EXCEPTION\_ON\_INIT,  
 DTOConstants.FAILURE\_REASON\_NO\_SERVLET\_CONTEXT\_MATCHING,  
 DTOConstants.FAILURE\_REASON\_SERVICE\_NOT\_GETTABLE,  
 DTOConstants.FAILURE\_REASON\_SERVLET\_CONTEXT\_FAILURE,  
 DTOConstants.FAILURE\_REASON\_SHADOWED\_BY\_OTHER\_SERVICE

**140.15.10.2**      **public FailedServletDTO()**

**140.15.11**      **public class FilterDTO**  
**extends DTO**

Represents a servlet `javax.servlet.Filter` service currently being used for by a servlet context.

*Concurrency* Not Thread-safe

**140.15.11.1**      **public boolean asyncSupported**

Specifies whether the servlet filter supports asynchronous processing.

**140.15.11.2**      **public String[] dispatcher**

The dispatcher associations for the servlet filter.

The specified names are used to determine in what occasions the servlet filter is called. This array is never null.

**140.15.11.3**      **public Map<String,String> initParams**

The servlet filter initialization parameters as provided during registration of the servlet filter. Additional parameters like the Http Service Runtime attributes are not included. If the servlet filter has not initialization parameters, this map is empty.

**140.15.11.4**      **public String name**

The name of the servlet filter. This field is never null.

**140.15.11.5**      **public String[] patterns**

The request mappings for the servlet filter.

The specified patterns are used to determine whether a request is mapped to the servlet filter. This array might be empty.

**140.15.11.6**      **public String[] regexs**

The request mappings for the servlet filter.

The specified regular expressions are used to determine whether a request is mapped to the servlet filter. This array might be empty.

**140.15.11.7**      **public long serviceId**

Service property identifying the servlet filter. In the case of a servlet filter registered in the service registry and picked up by a Http Whiteboard Implementation, this value is not negative and corresponds to the service id in the registry. If the servlet filter has not been registered in the service registry, the value is negative and a unique negative value is generated by the Http Service Runtime in this case.

**140.15.11.8**      **public long servletContextId**

The service id of the servlet context for the servlet filter represented by this DTO.

**140.15.11.9**      **public String[] servletNames**

The servlet names for the servlet filter.

The specified names are used to determine the servlets whose requests are mapped to the servlet filter. This array might be empty.

**140.15.11.10**      **public FilterDTO()**

**140.15.12      public class ListenerDTO  
extends DTO**

Represents a listener currently being used by a servlet context.

*Concurrency* Not Thread-safe

**140.15.12.1      public long serviceId**

Service property identifying the listener. In the case of a Listener registered in the service registry and picked up by a Http Whiteboard Implementation, this value is not negative and corresponds to the service id in the registry. If the listener has not been registered in the service registry, the value is negative and a unique negative value is generated by the Http Service Runtime in this case.

**140.15.12.2      public long servletContextId**

The service id of the servlet context for the listener represented by this DTO.

**140.15.12.3      public String[] types**

The fully qualified type names the listener. This array is never empty.

**140.15.12.4      public ListenerDTO()****140.15.13      public class RequestInfoDTO  
extends DTO**

Represents the services used to process a specific request.

*Concurrency* Not Thread-safe

**140.15.13.1      public FilterDTO[] filterDTOs**

The servlet filters processing this request. If no servlet filters are called for processing this request, an empty array is returned.

**140.15.13.2      public String path**

The path of the request relative to the root.

**140.15.13.3      public ResourceDTO resourceDTO**

The resource processing this request. If the request is processed by a resource, this field points to the DTO of the resource. If the request is processed by another type of component like a servlet, this field is null.

**140.15.13.4      public long servletContextId**

The service id of the servlet context processing the request represented by this DTO.

**140.15.13.5      public ServletDTO servletDTO**

The servlet processing this request. If the request is processed by a servlet, this field points to the DTO of the servlet. If the request is processed by another type of component like a resource, this field is null.

**140.15.13.6      public RequestInfoDTO()****140.15.14      public class ResourceDTO  
extends DTO**

Represents a resource definition currently being used by a servlet context.

*Concurrency* Not Thread-safe

- 140.15.14.1**      **public String[] patterns**  
The request mappings for the resource.  
The specified patterns are used to determine whether a request is mapped to the resource. This value is never null.
- 140.15.14.2**      **public String prefix**  
The prefix of the resource.
- 140.15.14.3**      **public long serviceId**  
Service property identifying the resource. In the case of a resource registered in the service registry and picked up by a Http Whiteboard Implementation, this value is not negative and corresponds to the service id in the registry. If the resource has not been registered in the service registry, the value is negative and a unique negative value is generated by the Http Service Runtime in this case.
- 140.15.14.4**      **public long servletContextId**  
The service id of the servlet context for the resource represented by this DTO.
- 140.15.14.5**      **public ResourceDTO()**
- 140.15.15**      **public class RuntimeDTO**  
**extends DTO**  
Represents the state of a Http Service Runtime.  
*Concurrency* Not Thread-safe
- 140.15.15.1**      **public FailedErrorPageDTO[] failedErrorPageDTOs**  
Returns the representations of the error page `javax.servlet.Servlet` services associated with this runtime but currently not used due to some problem. The returned array may be empty.
- 140.15.15.2**      **public FailedFilterDTO[] failedFilterDTOs**  
Returns the representations of the servlet `javax.servlet.Filter` services associated with this runtime but currently not used due to some problem. The returned array may be empty.
- 140.15.15.3**      **public FailedListenerDTO[] failedListenerDTOs**  
Returns the representations of the listeners associated with this runtime but currently not used due to some problem. The returned array may be empty.
- 140.15.15.4**      **public FailedResourceDTO[] failedResourceDTOs**  
Returns the representations of the resources associated with this runtime but currently not used due to some problem. The returned array may be empty.
- 140.15.15.5**      **public FailedServletContextDTO[] failedServletContextDTOs**  
Returns the representations of the `javax.servlet.ServletContext` objects currently not used by the Http service runtime due to some problem. The returned array may be empty.
- 140.15.15.6**      **public FailedServletDTO[] failedServletDTOs**  
Returns the representations of the `javax.servlet.Servlet` services associated with this runtime but currently not used due to some problem. The returned array may be empty.
- 140.15.15.7**      **public ServiceReferenceDTO serviceDTO**  
The DTO for the corresponding `org.osgi.service.http.runtime.HttpServiceRuntime`. This value is never null.

**140.15.15.8**      **public ServletContextDTO[] servletContextDTOs**

Returns the representations of the `javax.servlet.ServletContext` objects used by the Http Service Runtime. The returned array may be empty if the Http Service Runtime is currently not using any `javax.servlet.ServletContext` objects.

**140.15.15.9**      **public RuntimeDTO()****140.15.16**      **public class ServletContextDTO**  
**extends DTO**

Represents a `javax.servlet.ServletContext` created for servlets, resources, servlet Filters, and listeners associated with that servlet context. The Servlet Context is usually backed by a `org.osgi.service.http.context.ServletContextHelper` service.

*Concurrency* Not Thread-safe

**140.15.16.1**      **public Map<String, Object> attributes**

The servlet context attributes.

The value type must be a numerical type, Boolean, String, DTO or an array of any of the former. Therefore this method will only return the attributes of the servlet context conforming to this constraint. Other attributes are omitted. If there are no attributes conforming to the constraint, an empty map is returned.

**140.15.16.2**      **public String contextPath**

The servlet context path. This is the value returned by the `ServletContext.getContextPath()` method.

**140.15.16.3**      **public ErrorPageDTO[] errorPageDTOs**

Returns the representations of the error page Servlet services associated with this context. The representations of the error page Servlet services associated with this context. The returned array may be empty if this context is currently not associated with any error pages.

**140.15.16.4**      **public FilterDTO[] filterDTOs**

Returns the representations of the servlet Filter services associated with this context. The representations of the servlet Filter services associated with this context. The returned array may be empty if this context is currently not associated with any servlet Filter services.

**140.15.16.5**      **public Map<String, String> initParams**

The servlet context initialization parameters. This is the set of parameters provided when registering this context. Additional parameters like the Http Service Runtime attributes are not included. If the context has no initialization parameters, this map is empty.

**140.15.16.6**      **public ListenerDTO[] listenerDTOs**

Returns the representations of the listener services associated with this context. The representations of the listener services associated with this context. The returned array may be empty if this context is currently not associated with any listener services.

**140.15.16.7**      **public String name**

The name of the servlet context. The name of the corresponding `org.osgi.service.http.context.ServletContextHelper`.

This is the value returned by the `ServletContext.getServletContextName()` method.



**140.15.16.8 public ResourceDTO[] resourceDTOs**

Returns the representations of the resource services associated with this context. The representations of the resource services associated with this context. The returned array may be empty if this context is currently not associated with any resource services.

**140.15.16.9 public long serviceId**

Service property identifying the servlet context. In the case of a servlet context backed by a ServletContextHelper registered in the service registry and picked up by a Http Whiteboard Implementation, this value is not negative and corresponds to the service id in the registry. If the servlet context is not backed by a service registered in the service registry, the value is negative and a unique negative value is generated by the Http Service Runtime in this case.

**140.15.16.10 public ServletDTO[] servletDTOs**

Returns the representations of the Servlet services associated with this context. The representations of the Servlet services associated with this context. The returned array may be empty if this context is currently not associated with any Servlet services.

**140.15.16.11 public ServletContextDTO()****140.15.17 public class ServletDTO extends BaseServletDTO**

Represents a javax.servlet.Servlet currently being used by a servlet context.

*Concurrency* Not Thread-safe

**140.15.17.1 public String[] patterns**

The request mappings for the servlet.

The specified patterns are used to determine whether a request is mapped to the servlet. This array is never empty.

**140.15.17.2 public ServletDTO()****140.16 org.osgi.service.http.whiteboard**

Http Whiteboard Package Version 1.0.

Bundles wishing to use this package must list the package in the Import-Package header of the bundle's manifest. This package has two types of users: the consumers that use the API in this package and the providers that implement the API in this package.

Example import for consumers using the API in this package:

```
Import-Package: org.osgi.service.http.whiteboard; version="[1.0,2.0]"
```

Example import for providers implementing the API in this package:

```
Import-Package: org.osgi.service.http.whiteboard; version="[1.0,1.1]"
```

**140.16.1 Summary**

- HttpWhiteboardConstants - Defines standard constants for the Http Whiteboard services.

**140.16.2 public final class HttpWhiteboardConstants**

Defines standard constants for the Http Whiteboard services.

**140.16.2.1 public static final String DISPATCHER\_ASYNC = "ASYNC"**

Possible value for the HTTP\_WHITEBOARD\_FILTER\_DISPATCHER property indicating the servlet filter is applied in the asynchronous context.

*See Also* Java Servlet Specification Version 3.0, Section 6.2.5 Filters and the RequestDispatcher

**140.16.2.2 public static final String DISPATCHER\_ERROR = "ERROR"**

Possible value for the HTTP\_WHITEBOARD\_FILTER\_DISPATCHER property indicating the servlet filter is applied when an error page is called.

*See Also* Java Servlet Specification Version 3.0, Section 6.2.5 Filters and the RequestDispatcher

**140.16.2.3 public static final String DISPATCHER\_FORWARD = "FORWARD"**

Possible value for the HTTP\_WHITEBOARD\_FILTER\_DISPATCHER property indicating the servlet filter is applied to forward calls to the dispatcher.

*See Also* Java Servlet Specification Version 3.0, Section 6.2.5 Filters and the RequestDispatcher

**140.16.2.4 public static final String DISPATCHER\_INCLUDE = "INCLUDE"**

Possible value for the HTTP\_WHITEBOARD\_FILTER\_DISPATCHER property indicating the servlet filter is applied to include calls to the dispatcher.

*See Also* Java Servlet Specification Version 3.0, Section 6.2.5 Filters and the RequestDispatcher

**140.16.2.5 public static final String DISPATCHER\_REQUEST = "REQUEST"**

Possible value for the HTTP\_WHITEBOARD\_FILTER\_DISPATCHER property indicating the servlet filter is applied to client requests.

*See Also* Java Servlet Specification Version 3.0, Section 6.2.5 Filters and the RequestDispatcher

**140.16.2.6 public static final String HTTP\_WHITEBOARD\_CONTEXT\_INIT\_PARAM\_PREFIX = "context.init."**

Service property prefix referencing a ServletContextHelper service.

For ServletContextHelper services this prefix can be used for service properties to mark them as initialization parameters which can be retrieved from the associated servlet context. The prefix is removed from the service property name to build the initialization parameter name.

For ServletContextHelper services, the value of each initialization parameter service property must be of type String.

**140.16.2.7 public static final String HTTP\_WHITEBOARD\_CONTEXT\_NAME = "osgi.http.whiteboard.context.name"**

Service property specifying the name of an ServletContextHelper service.

For ServletContextHelper services, this service property must be specified. Context services without this service property are ignored.

Servlet, listener, servlet filter, and resource services might refer to a specific ServletContextHelper service referencing the name with the HTTP\_WHITEBOARD\_CONTEXT\_SELECT property.

For ServletContextHelper services, the value of this service property must be of type String. The value must follow the "symbolic-name" specification from Section 1.3.2 of the OSGi Core Specification.

*See Also* HTTP\_WHITEBOARD\_CONTEXT\_PATH, HTTP\_WHITEBOARD\_CONTEXT\_SELECT, HTTP\_WHITEBOARD\_DEFAULT\_CONTEXT\_NAME

**140.16.2.8 public static final String HTTP\_WHITEBOARD\_CONTEXT\_PATH = "osgi.http.whiteboard.context.path"**

Service property specifying the path of an ServletContextHelper service.

For ServletContextHelper services this service property is required. Context services without this service property are ignored.

This property defines a context path under which all whiteboard services associated with this context are registered. Having different contexts with different paths allows to separate the URL space.

For ServletContextHelper services, the value of this service property must be of type String. The value is either a slash for the root or it must start with a slash but not end with a slash. Valid characters are defined in rfc3986#section-3.3. Contexts with an invalid path are ignored.

*See Also* HTTP\_WHITEBOARD\_CONTEXT\_NAME, HTTP\_WHITEBOARD\_CONTEXT\_SELECT

**140.16.2.9**      **public static final String HTTP\_WHITEBOARD\_CONTEXT\_SELECT = "osgi.http.whiteboard.context.select"**

Service property referencing a ServletContextHelper service.

For servlet, listener, servlet filter, or resource services, this service property refers to the associated ServletContextHelper service. The value of this property is a filter expression which is matched against the service registration properties of the ServletContextHelper service. If this service property is not specified, the default context is used. If there is no context service matching, the servlet, listener, servlet filter, or resource service is ignored.

For example, if a whiteboard service wants to select a servlet context helper with the name "Admin" the expression would be "(osgi.http.whiteboard.context.name=Admin)". Selecting all contexts could be done with "(osgi.http.whiteboard.context.name=\*)".

For servlet, listener, servlet filter, or resource services, the value of this service property must be of type String.

*See Also* HTTP\_WHITEBOARD\_CONTEXT\_NAME, HTTP\_WHITEBOARD\_CONTEXT\_PATH

**140.16.2.10**      **public static final String HTTP\_WHITEBOARD\_DEFAULT\_CONTEXT\_NAME = "default"**

The name of the default ServletContextHelper. If a service is registered with this property, it is overriding the default context with a custom provided context.

*See Also* HTTP\_WHITEBOARD\_CONTEXT\_NAME

**140.16.2.11**      **public static final String HTTP\_WHITEBOARD\_FILTER\_ASYNC\_SUPPORTED = "osgi.http.whiteboard.filter.asyncSupported"**

Service property specifying whether a servlet Filter service supports asynchronous processing.

By default servlet filters services do not support asynchronous processing.

The value of this service property must be of type Boolean.

*See Also* Java Servlet Specification Version 3.0, Section 2.3.3.3 Asynchronous Processing

**140.16.2.12**      **public static final String HTTP\_WHITEBOARD\_FILTER\_DISPATCHER = "osgi.http.whiteboard.filter.dispatcher"**

Service property specifying the dispatcher handling of a servlet Filter.

By default servlet filter services are associated with client requests only (see value DISPATCHER\_REQUEST).

The value of this service property must be of type String, String[], or Collection<String>. Allowed values are DISPATCHER\_ASYNC, DISPATCHER\_ERROR, DISPATCHER\_FORWARD, DISPATCHER\_INCLUDE, DISPATCHER\_REQUEST.

*See Also* Java Servlet Specification Version 3.0, Section 6.2.5 Filters and the RequestDispatcher

**140.16.2.13**      **public static final String HTTP\_WHITEBOARD\_FILTER\_INIT\_PARAM\_PREFIX = "filter.init."**

Service property prefix referencing a Filter service.

For Filter services this prefix can be used for service properties to mark them as initialization parameters which can be retrieved from the associated filter config. The prefix is removed from the service property name to build the initialization parameter name.

For Filter services, the value of each initialization parameter service property must be of type String.

**140.16.2.14**     **public static final String HTTP\_WHITEBOARD\_FILTER\_NAME = "osgi.http.whiteboard.filter.name"**

Service property specifying the servlet filter name of a Filter service.

This name is used as the value for the `FilterConfig.getFilterName()` method. If this service property is not specified, the fully qualified name of the service object's class is used as the servlet filter name.

Servlet filter names should be unique among all servlet filter services associated with a single `ServletContextHelper`.

The value of this service property must be of type String.

**140.16.2.15**     **public static final String HTTP\_WHITEBOARD\_FILTER\_PATTERN = "osgi.http.whiteboard.filter.pattern"**

Service property specifying the request mappings for a Filter service.

The specified patterns are used to determine whether a request should be mapped to the servlet filter. Filter services without this service property or the `HTTP_WHITEBOARD_FILTER_SERVLET` or the `HTTP_WHITEBOARD_FILTER_REGEX` service property are ignored.

The value of this service property must be of type String, `String[]`, or `Collection<String>`.

*See Also* `Java Servlet Specification Version 3.0, Section 12.2 Specification of Mappings`

**140.16.2.16**     **public static final String HTTP\_WHITEBOARD\_FILTER\_REGEX = "osgi.http.whiteboard.filter.regex"**

Service property specifying the request mappings for a servlet Filter service.

The specified regular expressions are used to determine whether a request should be mapped to the servlet filter. The regular expressions must follow the syntax defined in `java.util.regex.Pattern`. Servlet filter services without this service property or the `HTTP_WHITEBOARD_FILTER_SERVLET` or the `HTTP_WHITEBOARD_FILTER_PATTERN` service property are ignored.

The value of this service property must be of type String, `String[]`, or `Collection<String>`.

*See Also* `java.util.regex.Pattern`

**140.16.2.17**     **public static final String HTTP\_WHITEBOARD\_FILTER\_SERVLET = "osgi.http.whiteboard.filter.servlet"**

Service property specifying the servlet names for a servlet Filter service.

The specified names are used to determine the servlets whose requests should be mapped to the servlet filter. Servlet filter services without this service property or the `HTTP_WHITEBOARD_FILTER_PATTERN` or the `HTTP_WHITEBOARD_FILTER_REGEX` service property are ignored.

The value of this service property must be of type String, `String[]`, or `Collection<String>`.

**140.16.2.18**     **public static final String HTTP\_WHITEBOARD\_LISTENER = "osgi.http.whiteboard.listener"**

Service property to mark a Listener service as a Whiteboard service. Listener services with this property set to the string value "true" will be treated as Whiteboard services opting in to being handled by the Http Whiteboard implementation. If the value "false" is specified, the service is opting out and this case is treated exactly the same as if this property is missing. If an invalid value is specified this is treated as a failure.

The value of this service property must be of type String. Valid values are "true" and "false" ignoring case.

**140.16.2.19**     **public static final String HTTP\_WHITEBOARD\_RESOURCE\_PATTERN = "osgi.http.whiteboard.resource.pattern"**

Service property specifying the request mappings for resources.

The specified patterns are used to determine whether a request should be mapped to resources. Resource services without this service property are ignored.

The value of this service property must be of type `String`, `String[]`, or `Collection<String>`.

*See Also* Java Servlet Specification Version 3.0, Section 12.2 Specification of Mappings, `HTTP_WHITEBOARD_RESOURCE_PREFIX`

**140.16.2.20**      **public static final String HTTP\_WHITEBOARD\_RESOURCE\_PREFIX = "osgi.http.whiteboard.resource.prefix"**

Service property specifying the resource entry prefix for a resource service.

If a resource service is registered with this property, requests are served with bundle resources.

This prefix is used to map a requested resource to the bundle's entries. The value must not end with slash ("/") with the exception that a name of the form "/" is used to denote the root of the bundle. See the specification text for details on how HTTP requests are mapped.

The value of this service property must be of type `String`.

*See Also* `HTTP_WHITEBOARD_RESOURCE_PATTERN`

**140.16.2.21**      **public static final String HTTP\_WHITEBOARD\_SERVLET\_ASYNC\_SUPPORTED = "osgi.http.whiteboard.servlet.asyncSupported"**

Service property specifying whether a Servlet service supports asynchronous processing.

By default servlet services do not support asynchronous processing.

The value of this service property must be of type `Boolean`.

*See Also* Java Servlet Specification Version 3.0, Section 2.3.3.3 Asynchronous Processing

**140.16.2.22**      **public static final String HTTP\_WHITEBOARD\_SERVLET\_ERROR\_PAGE = "osgi.http.whiteboard.servlet.errorPage"**

Service property specifying whether a Servlet service acts as an error page.

The service property values may be the name of a fully qualified exception class, a three digit HTTP status code, the value "4xx" for all error codes in the 400 range, or the value "5xx" for all error codes in the 500 range. Any value that is not a three digit number, or one of the two special values is considered to be the name of a fully qualified exception class.

The value of this service property must be of type `String`, `String[]`, or `Collection<String>`.

**140.16.2.23**      **public static final String HTTP\_WHITEBOARD\_SERVLET\_INIT\_PARAM\_PREFIX = "servlet.init."**

Service property prefix referencing a Servlet service.

For Servlet services this prefix can be used for service properties to mark them as initialization parameters which can be retrieved from the associated servlet config. The prefix is removed from the service property name to build the initialization parameter name.

For Servlet services, the value of each initialization parameter service property must be of type `String`.

**140.16.2.24**      **public static final String HTTP\_WHITEBOARD\_SERVLET\_NAME = "osgi.http.whiteboard.servlet.name"**

Service property specifying the servlet name of a Servlet service.

This name is used as the value for the `ServletConfig.getServletName()` method. If this service property is not specified, the fully qualified name of the service object's class is used as the servlet name. Filter services may refer to servlets by this name in their `HTTP_WHITEBOARD_FILTER_SERVLET` service property to apply the filter to the servlet.

Servlet names should be unique among all servlet services associated with a single `ServletContextHelper`.

The value of this service property must be of type String.

**140.16.2.25** **public static final String HTTP\_WHITEBOARD\_SERVLET\_PATTERN = "osgi.http.whiteboard.servlet.pattern"**

Service property specifying the request mappings for a Servlet service.

The specified patterns are used to determine whether a request should be mapped to the servlet. Servlet services without this service property or HTTP\_WHITEBOARD\_SERVLET\_ERROR\_PAGE are ignored.

The value of this service property must be of type String, String[], or Collection<String>.

*See Also* Java Servlet Specification Version 3.0, Section 12.2 Specification of Mappings

**140.16.2.26** **public static final String HTTP\_WHITEBOARD\_TARGET = "osgi.http.whiteboard.target"**

Service property specifying the target filter to select the Http Whiteboard implementation to process the service.

An Http Whiteboard implementation can define any number of service properties which can be referenced by the target filter. The service properties should always include the osgi.http.endpoint service property if the endpoint information is known.

If this service property is not specified, then all Http Whiteboard implementations can process the service.

The value of this service property must be of type String and be a valid filter string.

## 140.17 References

- [1] *HTTP 1.0 Specification RFC-1945*  
<http://www.ietf.org/rfc/rfc1945.txt>, May 1996
- [2] *HTTP 1.1 Specifications RFCs 7230-7235*  
<https://tools.ietf.org/html/rfc7230>, <https://tools.ietf.org/html/rfc7231>, <https://tools.ietf.org/html/rfc7232>, <https://tools.ietf.org/html/rfc7233>, <https://tools.ietf.org/html/rfc7234>, <https://tools.ietf.org/html/rfc7235>
- [3] *HTTP/2 Specifications*  
<https://http2.github.io>
- [4] *Java Servlet 3.1 Specification*  
<https://jcp.org/aboutjava/communityprocess/final/jsr340/>
- [5] *Portable Java Contract Definitions*  
<http://www.osgi.org/Specifications/ReferenceContract>
- [6] *RFC 2617: HTTP Authentication: Basic and Digest Access Authentication*  
<http://www.ietf.org/rfc/rfc2617.txt>
- [7] *Whiteboard Pattern*  
<http://www.osgi.org/wiki/uploads/Links/whiteboard.pdf>
- [8] *Core Service Hooks*  
OSGi Core, Chapter 55 Service Hook Service Specification

# 702 XML Parser Service Specification

## Version 1.0

### 702.1 Introduction

The Extensible Markup Language (XML) has become a popular method of describing data. As more bundles use XML to describe their data, a common XML Parser becomes necessary in an embedded environment in order to reduce the need for space. Not all XML Parsers are equivalent in function, however, and not all bundles have the same requirements on an XML parser.

This problem was addressed in the Java API for XML Processing, see [4] *JAXP* for Java 2 Standard Edition and Enterprise Edition. This specification addresses how the classes defined in JAXP can be used in an OSGi framework. It defines how:

- Implementations of XML parsers can become available to other bundles
- Bundles can find a suitable parser
- A standard parser in a JAR can be transformed to a bundle

#### 702.1.1 Essentials

- *Standards* - Leverage existing standards in Java based XML parsing: JAXP, SAX and DOM
- *Unmodified JAXP code* - Run unmodified JAXP code
- *Simple* - It should be easy to provide a SAX or DOM parser as well as easy to find a matching parser
- *Multiple* - It should be possible to have multiple implementations of parsers available
- *Extendable* - It is likely that parsers will be extended in the future with more functionality

#### 702.1.2 Entities

- *XMLParserActivator* - A utility class that registers a parser factory from declarative information in the Manifest file.
- *SAXParserFactory* - A class that can create an instance of a SAXParser class.
- *DocumentBuilderFactory* - A class that can create an instance of a DocumentBuilder class.
- *SAXParser* - A parser, instantiated by a SaxParserFactory object, that parses according to the SAX specifications.
- *DocumentBuilder* - A parser, instantiated by a DocumentBuilderFactory, that parses according to the DOM specifications.

Figure 702.1

XML Parsing diagram

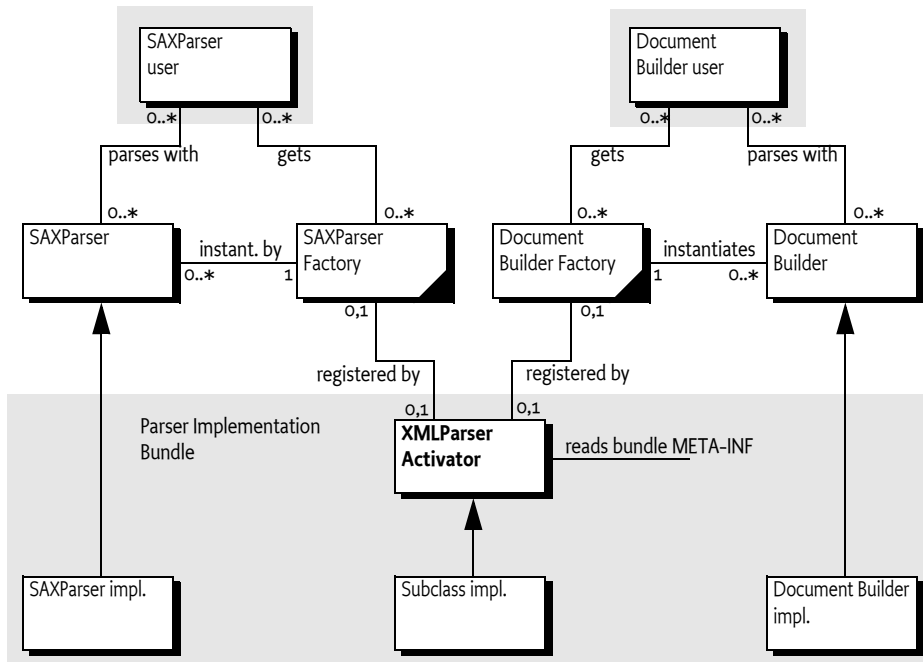

### 702.1.3

## Operations

A bundle containing a SAX or DOM parser is started. This bundle registers a SAXParserFactory and/or a DocumentBuilderFactory service object with the Framework. Service registration properties describe the features of the parsers to other bundles. A bundle that needs an XML parser will get a SAXParserFactory or DocumentBuilderFactory service object from the Framework service registry. This object is then used to instantiate the requested parsers according to their specifications.

## 702.2

## JAXP

XML has become very popular in the last few years because it allows the interchange of complex information between different parties. Though only a single XML standard exists, there are multiple APIs to XML parsers, primarily of two types:

- The Simple API for XML (SAX1 and SAX2)
- Based on the Document Object Model (DOM 1 and 2)

Both standards, however, define an abstract API that can be implemented by different vendors.

A given XML Parser implementation may support either or both of these parser types by implementing the `org.w3c.dom` and/or `org.xml.sax` packages. In addition, parsers have characteristics such as whether they are validating or non-validating parsers and whether or not they are namespace aware.

An application which uses a specific XML Parser must code to that specific parser and become coupled to that specific implementation. If the parser has implemented [4] JAXP, however, the application developer can code against SAX or DOM and let the runtime environment decide which parser implementation is used.

JAXP uses the concept of a *factory*. A factory object is an object that abstracts the creation of another object. JAXP defines a `DocumentBuilderFactory` and a `SAXParserFactory` class for this purpose.



JAXP is implemented in the `javax.xml.parsers` package and provides an abstraction layer between an application and a specific XML Parser implementation. Using JAXP, applications can choose to use any JAXP compliant parser without changing any code, simply by changing a System property which specifies the SAX- and DOM factory class names.

In JAXP, the default factory is obtained with a static method in the `SAXParserFactory` or `DocumentBuilderFactory` class. This method will inspect the associated System property and create a new instance of that class.

## 702.3 XML Parser service

The current specification of JAXP has the limitation that only one of each type of parser factories can be registered. This specification specifies how multiple `SAXParserFactory` objects and `DocumentBuilderFactory` objects can be made available to bundles simultaneously.

Providers of parsers should register a JAXP factory object with the OSGi service registry under the factory class name. Service properties are used to describe whether the parser:

- Is validating
- Is name-space aware
- Has additional features

With this functionality, bundles can query the OSGi service registry for parsers supporting the specific functionality that they require.

## 702.4 Properties

Parsers must be registered with a number of properties that qualify the service. In this specification, the following properties are specified:

- [PARSER\\_NAMESPACEAWARE](#) - The registered parser is aware of name-spaces. Name-spaces allow an XML document to consist of independently developed DTDs. In an XML document, they are recognized by the `xmlns` attribute and names prefixed with an abbreviated name-space identifier, like: `<xsl:if ...>`. The type is a Boolean object that must be true when the parser supports name-spaces. All other values, or the absence of the property, indicate that the parser does not implement name-spaces.
- [PARSER\\_VALIDATING](#) - The registered parser can read the DTD and can validate the XML accordingly. The type is a Boolean object that must true when the parser is validating. All other values, or the absence of the property, indicate that the parser does not validate.

## 702.5 Getting a Parser Factory

Getting a parser factory requires a bundle to get the appropriate factory from the service registry. In a simple case in which a non-validating, non-name-space aware parser would suffice, it is best to use `getServiceReference(String)`.

```
DocumentBuilder getParser(BundleContext context)
    throws Exception {
    ServiceReference ref = context.getServiceReference(
        DocumentBuilderFactory.class.getName() );
    if ( ref == null )
        return null;
```

```

    DocumentBuilderFactory factory =
        (DocumentBuilderFactory) context.getService(ref);
    return factory.newDocumentBuilder();
}

```

In a more demanding case, the filtered version allows the bundle to select a parser that is validating and name-space aware:

```

SAXParser getParser(BundleContext context)
    throws Exception {
    ServiceReference refs[] = context.getServiceReferences(
        SAXParserFactory.class.getName(),
        "(&(parser.namespaceAware=true)"
        + "(parser.validating=true))");
    if ( refs == null )
        return null;
    SAXParserFactory factory =
        (SAXParserFactory) context.getService(refs[0]);
    return factory.newSAXParser();
}

```

## 702.6 Adapting a JAXP Parser to OSGi

If an XML Parser supports JAXP, then it can be converted to an OSGi aware bundle by adding a `BundleActivator` class which registers an XML Parser Service. The utility `org.osgi.util.xml.XMLParserActivator` class provides this function and can be added (copied, not referenced) to any XML Parser bundle, or it can be extended and customized if desired.

### 702.6.1 JAR Based Services

Its functionality is based on the definition of the [5] *JAR File specification, services directory*. This specification defines a concept for service providers. A JAR file can contain an implementation of an abstractly defined service. The class (or classes) implementing the service are designated from a file in the `META-INF/services` directory. The name of this file is the same as the abstract service class.

The content of the UTF-8 encoded file is a list of class names separated by new lines. White space is ignored and the number sign (`'#' \u0023`) is the comment character.

JAXP uses this service provider mechanism. It is therefore likely that vendors will place these service files in the `META-INF/services` directory.

### 702.6.2 XMLParserActivator

To support this mechanism, the XML Parser service provides a utility class that should be normally delivered with the OSGi framework implementation. This class is a `BundleActivator` and must start when the bundle is started. This class is copied into the parser bundle, and *not* imported.

The start method of the utility `BundleActivator` class will look in the `META-INF/services` service provider directory for the files `javax.xml.parsers.SAXParserFactory` (`SAXFACTORYNAME`) or `javax.xml.parsers.DocumentBuilderFactory` (`DOMFACTORYNAME`). The full path name is specified in the constants `SAXCLASSFILE` and `DOMCLASSFILE` respectively.

If either of these files exist, the utility `BundleActivator` class will parse the contents according to the specification. A service provider file can contain multiple class names. Each name is read and a new instance is created. The following example shows the possible content of such a file:

```
# ACME example SAXParserFactory file
```

```
com.acme.saxparser.SAXParserFast           # Fast
com.acme.saxparser.SAXParserValidating    # Validates
```

Both the `javax.xml.parsers.SAXParserFactory` and the `javax.xml.parsers.DocumentBuilderFactory` provide methods that describe the features of the parsers they can create. The `XMLParserActivator` activator will use these methods to set the values of the properties, as defined in *Properties* on page 1109, that describe the instances.

### 702.6.3 Adapting an Existing JAXP Compatible Parser

To incorporate this bundle activator into a XML Parser Bundle, do the following:

- If SAX parsing is supported, create a `/META-INF/services/javax.xml.parsers.SAXParserFactory` resource file containing the class names of the `SAXParserFactory` classes.
- If DOM parsing is supported, create a `/META-INF/services/javax.xml.parsers.DocumentBuilderFactory` file containing the fully qualified class names of the `DocumentBuilderFactory` classes.
- Create manifest file which imports the packages `org.w3c.dom`, `org.xml.sax`, and `javax.xml.parsers`.
- Add a `Bundle-Activator` header to the manifest pointing to the `XMLParserActivator`, the sub-class that was created, or a fully custom one.
- If the parsers support attributes, properties, or features that should be registered as properties so they can be searched, extend the `XMLParserActivator` class and override `setSAXProperties(javax.xml.parsers.SAXParserFactory, Hashtable)` and `setDOMProperties(javax.xml.parsers.DocumentBuilderFactory, Hashtable)`.
- Ensure that custom properties are put into the `Hashtable` object. JAXP does not provide a way for `XMLParserActivator` to query the parser to find out what properties were added.
- Bundles that extend the `XMLParserActivator` class must call the original methods via `super` to correctly initialize the XML Parser Service properties.
- Compile this class into the bundle.
- Install the new XML Parser Service bundle.
- Ensure that the `org.osgi.util.xml.XMLParserActivator` class is contained in the bundle.

## 702.7 Usage of JAXP

A single bundle should export the JAXP, SAX, and DOM APIs. The version of contained packages must be appropriately labeled. JAXP 1.1 or later is required which references SAX 2 and DOM 2. See [4] *JAXP* for the exact version dependencies.

This specification is related to related packages as defined in the JAXP 1.1 document. The following table contains the expected minimum versions.

Table 702.1 *JAXP 1.1 minimum package versions*

Package	Minimum Version
<code>javax.xml.parsers</code>	1.1
<code>org.xml.sax</code>	2.0
<code>org.xml.sax.helpers</code>	2.0
<code>org.xml.sax.ext</code>	1.0
<code>org.w3c.dom</code>	2.0

The Xerces project from the Apache group, [6] *Xerces 2 Java Parser*, contains a number libraries that implement the necessary APIs. These libraries can be wrapped in a bundle to provide the relevant packages.

## 702.8 Security

A centralized XML parser is likely to see sensitive information from other bundles. Provisioning an XML parser should therefore be limited to trusted bundles. This security can be achieved by providing `ServicePermission[javax.xml.parsers.DocumentBuilderFactory|javax.xml.parsers.SAXFactory,REGISTER]` to only trusted bundles.

Using an XML parser is a common function, and `ServicePermission[javax.xml.parsers.DOMParserFactory|javax.xml.parsers.SAXFactory, GET]` should not be restricted.

The XML parser bundle will need `FilePermission[<<ALL FILES>>,READ]` for parsing of files because it is not known beforehand where those files will be located. This requirement further implies that the XML parser is a system bundle that must be fully trusted.

## 702.9 org.osgi.util.xml

XML Parser Package Version 1.0.

Bundles wishing to use this package must list the package in the `Import-Package` header of the bundle's manifest.

Example import for consumers using the API in this package:

```
Import-Package: org.osgi.util.xml; version="[1.0,2.0)"
```

### 702.9.1 Summary

- `XMLParserActivator` - A `BundleActivator` class that allows any JAXP compliant XML Parser to register itself as an OSGi parser service.

### 702.9.2 public class XMLParserActivator implements BundleActivator, ServiceFactory

A `BundleActivator` class that allows any JAXP compliant XML Parser to register itself as an OSGi parser service. Multiple JAXP compliant parsers can concurrently register by using this `BundleActivator` class. Bundles who wish to use an XML parser can then use the framework's service registry to locate available XML Parsers with the desired characteristics such as validating and namespace-aware.

The services that this bundle activator enables a bundle to provide are:

- `javax.xml.parsers.SAXParserFactory(SAXFACTORYNAME)`
- `javax.xml.parsers.DocumentBuilderFactory(DOMFACTORYNAME)`

The algorithm to find the implementations of the abstract parsers is derived from the JAR file specifications, specifically the Services API.

An `XMLParserActivator` assumes that it can find the class file names of the factory classes in the following files:

- `/META-INF/services/javax.xml.parsers.SAXParserFactory` is a file contained in a jar available to the runtime which contains the implementation class name(s) of the `SAXParserFactory`.
- `/META-INF/services/javax.xml.parsers.DocumentBuilderFactory` is a file contained in a jar available to the runtime which contains the implementation class name(s) of the `DocumentBuilderFactory`

If either of the files does not exist, XMLParserActivator assumes that the parser does not support that parser type.

XMLParserActivator attempts to instantiate both the SAXParserFactory and the DocumentBuilderFactory. It registers each factory with the framework along with service properties:

- `PARSER_VALIDATING`- indicates if this factory supports validating parsers. It's value is a Boolean.
- `PARSER_NAMESPACEAWARE`- indicates if this factory supports namespace aware parsers. Its value is a Boolean.

Individual parser implementations may have additional features, properties, or attributes which could be used to select a parser with a filter. These can be added by extending this class and overriding the `setSAXProperties` and `setDOMProperties` methods.

*Concurrency* Thread-safe

**702.9.2.1**      **public static final String DOMCLASSFILE = "/META-INF/services/javax.xml.parsers.DocumentBuilderFactory"**  
Fully qualified path name of DOM Parser Factory Class Name file

**702.9.2.2**      **public static final String DOMFACTORYNAME = "javax.xml.parsers.DocumentBuilderFactory"**  
Filename containing the DOM Parser Factory Class name. Also used as the basis for the `SERVICE_PID` registration property.

**702.9.2.3**      **public static final String PARSER\_NAMESPACEAWARE = "parser.namespaceAware"**  
Service property specifying if factory is configured to support namespace aware parsers. The value is of type Boolean.

**702.9.2.4**      **public static final String PARSER\_VALIDATING = "parser.validating"**  
Service property specifying if factory is configured to support validating parsers. The value is of type Boolean.

**702.9.2.5**      **public static final String SAXCLASSFILE = "/META-INF/services/javax.xml.parsers.SAXParserFactory"**  
Fully qualified path name of SAX Parser Factory Class Name file

**702.9.2.6**      **public static final String SAXFACTORYNAME = "javax.xml.parsers.SAXParserFactory"**  
Filename containing the SAX Parser Factory Class name. Also used as the basis for the `SERVICE_PID` registration property.

**702.9.2.7**      **public XMLParserActivator()**

**702.9.2.8**      **public Object getService(Bundle bundle, ServiceRegistration registration)**

*bundle* The bundle using the service.

*registration* The ServiceRegistration object for the service.

- Creates a new XML Parser Factory object.

A unique XML Parser Factory object is returned for each call to this method.

The returned XML Parser Factory object will be configured for validating and namespace aware support as specified in the service properties of the specified ServiceRegistration object. This method can be overridden to configure additional features in the returned XML Parser Factory object.

*Returns* A new, configured XML Parser Factory object or null if a configuration error was encountered

**702.9.2.9**      **public void setDOMProperties(DocumentBuilderFactory factory, Hashtable props)**

*factory* - the DocumentBuilderFactory object

*props* - Hashtable of service properties.

Set the customizable DOM Parser Service Properties.

This method attempts to instantiate a validating parser and a namespace aware parser to determine if the parser can support those features. The appropriate properties are then set in the specified *props* object.

This method can be overridden to add additional DOM2 features and properties. If you want to be able to filter searches of the OSGi service registry, this method must put a key, value pair into the properties object for each feature or property. For example, `properties.put("http://www.acme.com/features/foo", Boolean.TRUE);`

#### **702.9.2.10 public void setSAXProperties(SAXParserFactory factory,Hashtable properties)**

*factory* - the SAXParserFactory object

*properties* - the properties object for the service

Set the customizable SAX Parser Service Properties.

This method attempts to instantiate a validating parser and a namespace aware parser to determine if the parser can support those features. The appropriate properties are then set in the specified properties object.

This method can be overridden to add additional SAX2 features and properties. If you want to be able to filter searches of the OSGi service registry, this method must put a key, value pair into the properties object for each feature or property. For example, `properties.put("http://www.acme.com/features/foo", Boolean.TRUE);`

#### **702.9.2.11 public void start(BundleContext context) throws Exception**

*context* The execution context of the bundle being started.

- Called when this bundle is started so the Framework can perform the bundle-specific activities necessary to start this bundle. This method can be used to register services or to allocate any resources that this bundle needs.

This method must complete and return to its caller in a timely manner.

This method attempts to register a SAX and DOM parser with the Framework's service registry.

*Throws* Exception— If this method throws an exception, this bundle is marked as stopped and the Framework will remove this bundle's listeners, unregister all services registered by this bundle, and release all services used by this bundle.

#### **702.9.2.12 public void stop(BundleContext context) throws Exception**

*context* The execution context of the bundle being stopped.

- This method has nothing to do as all active service registrations will automatically get unregistered when the bundle stops.

*Throws* Exception— If this method throws an exception, the bundle is still marked as stopped, and the Framework will remove the bundle's listeners, unregister all services registered by the bundle, and release all services used by the bundle.

#### **702.9.2.13 public void ungetService(Bundle bundle,ServiceRegistration registration,Object service)**

*bundle* The bundle releasing the service.

*registration* The ServiceRegistration object for the service.

*service* The XML Parser Factory object returned by a previous call to the `getService` method.

- Releases a XML Parser Factory object.

## 702.10 References

- [1] *XML*  
<http://www.w3.org/XML>
- [2] *SAX*  
<http://www.saxproject.org/>
- [3] *DOM Java Language Binding*  
<http://www.w3.org/TR/REC-DOM-Level-1/java-language-binding.html>
- [4] *JAXP*  
<http://jaxp.java.net/>
- [5] *JAR File specification, services directory*  
<http://download.oracle.com/javase/1.4.2/docs/guide/jar/jar.html>
- [6] *Xerces 2 Java Parser*  
<http://xerces.apache.org/xerces2-j/>





# 703 Position Specification

## Version 1.0

### 703.1 Introduction

The Position class is a utility providing bundle developers with a consistent way of handling geographic positions in OSGi applications. The Position class is intended to be used with the Wire Admin service but has wider applicability.

The Position class is designed to be compatible with the Global Positioning System (GPS). This specification will not define or explain the complexities of positioning information. It is assumed that the reader has the appropriate background to understand this information.

#### 703.1.1 Essentials

- *Position* - Provide an information object that has well defined semantics for a position.
- *WGS-84* - Use the World Geodetic System 84 as the datum.
- *Speed* - Provide speed and track information.
- *Errors* - Position information always has certain errors or cannot be measured at all. This information must be available to the users of the information.
- *Units* - Use SI units for all measurements.
- *Wire Admin* - This specification must work within the Wire Admin service.

#### 703.1.2 Entities

- *Position* - An object containing the different aspects of a position.
- *Measurement* - Contains a typed measurement made at a certain time and with a specified error.

Figure 703.1

Class Diagram, *org.osgi.util.position*

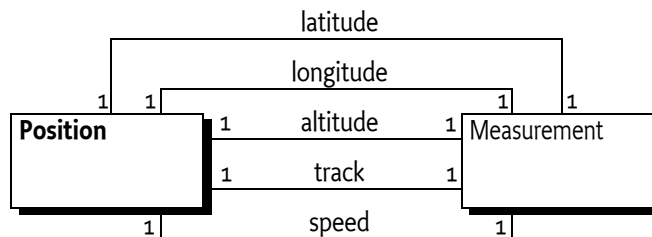

### 703.2 Positioning

The Position class is used to give information about the position and movement of a vehicle with a specified amount of uncertainty. The position is based on WGS-84.

The Position class offers the following information:

- `getLatitude()` - The WGS-84 latitude of the current position. The unit of a latitude must be rad (radians).

- `getLongitude()` - The WGS-84 longitude of the current position. The unit of a longitude must be rad (radians).
- `getAltitude()` - Altitude is expressed as height in meters above the WGS-84 ellipsoid. This value can differ from the actual height above mean sea level depending on the place on earth where the measurement is taken place. This value is not corrected for the geoid.
- `getTrack()` - The true north course of the vehicle in radians.
- `getSpeed()` - The ground speed. This speed must not include vertical speed.

## 703.3 Units

Longitude and latitude are represented in radians, not degrees. This is consistent with the use of the Measurement object. Radians can be converted to degrees with the following formula, when lonlat is the longitude or latitude:

$$\text{degrees} = (\text{lonlat} / \pi) * 180$$

Calculation errors are significantly reduced when all calculations are done with a single unit system. This approach increases the complexity of presentation, but presentations are usually localized and require conversion anyway. Also, the radians are the units in the SI system and the `java.lang.Math` class uses only radians for angles.

## 703.4 Optimizations

A Position object must be immutable. It must remain its original values after it is created.

The Position class is not final. This approach implies that developers are allowed to sub-class it and provide optimized implementations. For example, it is possible that the Measurement objects are only constructed when actually requested.

## 703.5 Errors

Positioning information is never exact. Even large errors can exist in certain conditions. For this reason, the Position class returns all its measurements as Measurement objects. The Measurement class maintains an error value for each measurement.

In certain cases it is not possible to supply a value; in those cases, the method should return a NaN as specified in the Measurement class.

## 703.6 Using Position With Wire Admin

The primary reason the Position is specified, is to use it with the *Wire Admin Service Specification* on page 199. A bundle that needs position information should register a Consumer service and the configuration should connect this service to an appropriate Producer service.

## 703.7 Related Standards

### 703.7.1 JSR 179

In JCP, started [2] *Location API for J2ME*. This API is targeted at embedded systems and is likely to not contain some of the features found in this API. This API is targeted to be reviewed at Q4 of 2002. This API should be considered in a following release.

## 703.8 Security

The security aspects of the Position class are delegated to the security aspects of the Wire Admin service. The Position object only carries the information. The Wire Admin service will define what Consumer services will receive position information from what Producer services. It is therefore up to the administrator of the Wire Admin service to assure that only trusted bundles receive this information, or can supply it.

## 703.9 org.osgi.util.position

Position Package Version 1.0.

Bundles wishing to use this package must list the package in the Import-Package header of the bundle's manifest.

Example import for consumers using the API in this package:

```
Import-Package: org.osgi.util.position; version="[1.0,2.0]"
```

### 703.9.1 Summary

- Position - Position represents a geographic location, based on the WGS84 System (World Geodetic System 1984).

### 703.9.2 public class Position

Position represents a geographic location, based on the WGS84 System (World Geodetic System 1984).

The org.osgi.util.measurement.Measurement class is used to represent the values that make up a position.

A given position object may lack any of it's components, i.e. the altitude may not be known. Such missing values will be represented by null.

Position does not override the implementation of either equals() or hashCode() because it is not clear how missing values should be handled. It is up to the user of a position to determine how best to compare two position objects. A Position object is immutable.

*Concurrency* Immutable

#### 703.9.2.1 public Position(Measurement lat, Measurement lon, Measurement alt, Measurement speed, Measurement track)

*lat* a Measurement object specifying the latitude in radians, or null

*lon* a Measurement object specifying the longitude in radians, or null

*alt* a Measurement object specifying the altitude in meters, or null

*speed* a Measurement object specifying the speed in meters per second, or null

*track* a Measurement object specifying the track in radians, or null

- Constructs a Position object with the given values.

#### **703.9.2.2 public Measurement getAltitude()**

- Returns the altitude of this position in meters.

*Returns* a Measurement object in Unit.m representing the altitude in meters above the ellipsoid null if the altitude is not known.

#### **703.9.2.3 public Measurement getLatitude()**

- Returns the latitude of this position in radians.

*Returns* a Measurement object in Unit.rad representing the latitude, or null if the latitude is not known..

#### **703.9.2.4 public Measurement getLongitude()**

- Returns the longitude of this position in radians.

*Returns* a Measurement object in Unit.rad representing the longitude, or null if the longitude is not known.

#### **703.9.2.5 public Measurement getSpeed()**

- Returns the ground speed of this position in meters per second.

*Returns* a Measurement object in Unit.m\_s representing the speed, or null if the speed is not known..

#### **703.9.2.6 public Measurement getTrack()**

- Returns the track of this position in radians as a compass heading. The track is the extrapolation of previous previously measured positions to a future position.

*Returns* a Measurement object in Unit.rad representing the track, or null if the track is not known..

## **703.10 References**

- [1] *World Geodetic System 84 (WGS-84)*  
[http://earth-info.nga.mil/GandG/publications/tr8350.2/tr8350\\_2.html](http://earth-info.nga.mil/GandG/publications/tr8350.2/tr8350_2.html)
- [2] *Location API for J2ME*  
<http://www.jcp.org/jst/detail/179.jsp>

# 704 Measurement and State Specification

*Version 1.0*

## 704.1 Introduction

The Measurement class is a utility that provides a consistent way of handling a diverse range of measurements for bundle developers. Its purpose is to simplify the correct handling of measurements in OSGi Frameworks.

OSGi bundle developers from all over the world have different preferences for measurement units, such as feet versus meters. In an OSGi environment, bundles developed in different parts of the world can and will exchange measurements when collaborating.

Distributing a measurement such as a simple floating point number requires the correct and equal understanding of the measurement's semantic by both the sender and the receiver. Numerous accidents have occurred due to misunderstandings between the sender and receiver because there are so many different ways to represent the same value. For example, on September 23, 1999, the Mars Polar Lander was lost because calculations used to program the craft's trajectory were input with English units while the operation documents specified metric units. See [5] *Mars Polar Lander failure* for more information.

This Measurement and State Specification defines the norm that should be used by all applications that execute in an OSGi Framework. This specification also provides utility classes.

### 704.1.1 Measurement Essentials

- *Numerical error* - All floating point measurements should be able to have a numerical error.
- *Numerical error calculations simplification* - Support should be provided to simplify measurements calculations.
- *Unit conflict resolution* - It must not be possible to perform addition or subtraction with different units when they are not compatible. For example, it must not be possible to add meters to amperes or watts to pascals.
- *Unit coercion* - Multiplication and division operations involving more than one type of measurement must result in a different unit. For example, if meters are divided by seconds, the result must be a new unit that represents m/s.
- *Time-stamp* - Measurements should contain a time-stamp so that bundles can determine the age of a particular measurement.
- *Support for floating and discrete values* - Both floating point values (64 bit Java double floats) and discrete measurements (32 bit Java int) should be supported.
- *Consistency* - The method of error calculation and handling of unit types should be consistent.
- *Presentation* - The format of measurements and specified units should be easy to read and understand.

### 704.1.2 Measurement Entities

- *Measurement object* - A Measurement object contains a double value, a double error, and a long time-stamp. It is associated with a Unit object that represents its *type*.
- *State object* - A State object contains a discrete measurement (int) with a time-stamp and a name.
- *Unit object* - A Unit object represents a unit such as meter, second, mol, or Pascal. A number of Unit objects are predefined and have common names. Other Unit objects are created as needed from the 7 basic Système International d'Unité (SI) units. Different units are *not* used when a conversion is sufficient. For example, the unit of a Measurement object for length is *always* meters. If the length is needed in feet, then the number of feet is calculated by multiplying the value of the Measurement object in meters with the necessary conversion factor.
- *Error* - When a measurement is taken, it is *never* accurate. This specification defines the error as the value that is added and subtracted to the value to produce an interval, where the probability is 95% that the actual value falls within this interval.
- *Unit* - A unit is the *type* of a measurement: meter, feet, liter, gallon etc.
- *Base Unit* - One of the 7 base units defined in the SI.
- *Derived SI unit* - A unit is a derived SI unit when it is a combination of exponentiated base units. For example, a volt (V) is a derived unit because it can be expressed as  $(m^2 \times kg) / (s^3 \times A)$ , where m, kg, s and A are all base units.
- *Quantitative derivation* - A unit is quantitatively derived when it is converted to one of the base units or derived units using a conversion formula. For example, kilometers (km) can be converted to meters (m), gallons can be converted to liters, or horsepower can be converted to watts.

Figure 704.1

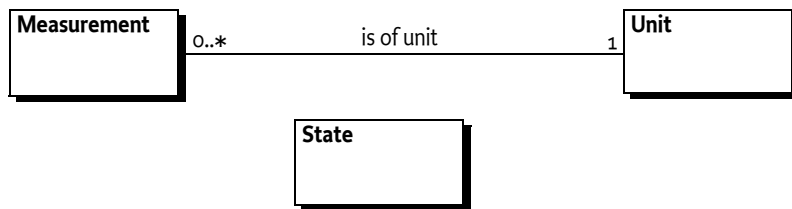
Class Diagram, `org.osgi.util.measurement`

## 704.2 Measurement Object

A Measurement object contains a value, an error, and a time-stamp. It is linked to a Unit object that describes the measurement unit in an SI Base Unit or Derived SI Unit.

### 704.2.1 Value

The value of the Measurement object is the measured value. It is set in a constructor. The type of the value is double.

### 704.2.2 Error

The Measurement object can contain a numerical error. This error specifies an interval by adding and subtracting the error value from the measured value. The type of the error is double. A valid error value indicates that the actual measured value has a 95% chance of falling within this interval (see Figure 704.2). If the error is not known it should be represented as a `Double.NaN`.

Figure 704.2 The Error Interval

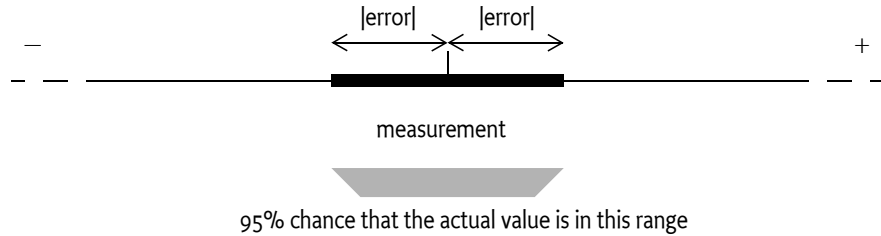

### 704.2.3 Time-stamp

When a Measurement object is created, the time-stamp can be set. A time-stamp is a long value representing the number of milliseconds since the epoch midnight of January 1, 1970, UTC (this is the value from `System.currentTimeMillis()` method).

By default, a time-stamp is not set because the call to `System.currentTimeMillis()` incurs overhead. If the time-stamp is not set when the Measurement object is created, then its default value is zero. If the time-stamp is set, the creator of the Measurement object must give the time as an argument to the constructor. For example:

```
Measurement m = new Measurement(
    v, e, null, System.currentTimeMillis() );
```

## 704.3 Error Calculations

Once a measurement is taken, it often is used in calculations. The error value assigned to the result of a calculation depends largely on the error values of the operands. Therefore, the Measurement class offers addition, subtraction, multiplication, and division functions for measurements and constants. These functions take the error into account when performing the specific operation.

The Measurement class uses absolute errors and has methods to calculate a new absolute error when multiplication, division, addition, or subtraction is performed. Error calculations must therefore adhere to the rules listed in the following table. In this table,  $\Delta a$  is the absolute positive error in a value  $a$  and  $\Delta b$  is the absolute positive error in a value  $b$ .  $c$  is a constant floating point value without an error.

Table 704.1 Error Calculation Rules

Calculation	Function	Error
$a \times b$	<code>mul(Measurement)</code>	$ \Delta a \times b  +  a \times \Delta b $
$a / b$	<code>div(Measurement)</code>	$( \Delta a \times b  +  a \times \Delta b ) / b^2$
$a + b$	<code>add(Measurement)</code>	$\Delta a + \Delta b$
$a - b$	<code>sub(Measurement)</code>	$\Delta a + \Delta b$
$a \times c$	<code>mul(double)</code>	$ \Delta a \times c $
$a / c$	<code>div(double)</code>	$ \Delta a / c $
$a + c$	<code>add(double)</code>	$\Delta a$
$a - c$	<code>sub(double)</code>	$\Delta a$

## 704.4 Constructing and Comparing Measurements

Measurement objects have a value and an error range, making comparing and constructing these objects more complicated than normal scalars.

### 704.4.1 Constructors

The Measurements object has the following constructors that the value, error, unit and timestamp:

- `Measurement(double,double,Unit,long)`
- `Measurement(double,double,Unit)`
- `Measurement(double,Unit)`
- `Measurement(double)`

### 704.4.2 Identity and Equality

Both `equals(Object)` and `hashCode()` methods are overridden to provide value-based equality. Two Measurement objects are equal when the unit, error, and value are the same. The time-stamp is not relevant for equality or the hash code.

### 704.4.3 Comparing Measurement Objects

The Measurement class implements the `java.lang.Comparable` interface and thus implements the `compareTo(Object)` method. Comparing two Measurement objects is not straightforward, however, due to the associated error. The error effectively creates a range, so comparing two Measurement objects is actually comparing intervals.

Two Measurement objects are considered to be equal when their intervals overlap. In all other cases, the value is used in the comparison.

Figure 704.3 Comparing Measurement Objects

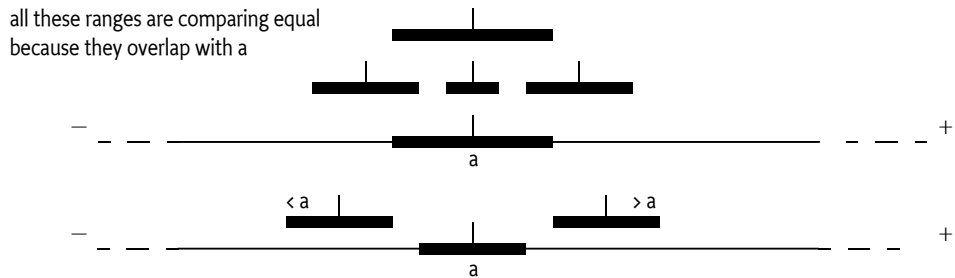

This comparison implies that the `equals(Object)` method may return false while the `compareTo(Object)` method returns 0 for the same Measurement object.

## 704.5 Unit Object

Each Measurement object is related to a Unit object. The Unit object defines the unit of the measurement value and error. For example, the Unit object might define the unit of the measurement value and the error as meters (m). For convenience, the Unit class defines a number of standard units as constants. Measurement objects are given a specific Unit with the constructor. The following example shows how a measurement can be associated with meters (m):

```
Measurement length = new Measurement( v, 0.01,Unit.m );
```

Units are based on the *Système International d'Unité* (SI), developed after the French Revolution. The SI consists of 7 different units that can be combined in many ways to form a large series of derived units. The basic 7 units are listed in the following table. For more information, see [2] *General SI index*.



Table 704.2

*Basic SI units.*

Description	Unit name	Symbol
length	meter	m
mass	kilogram	kg
time	second	s
electric current	ampere	A
thermodynamic temperature	kelvin	K
amount of substance	mole	mol
luminous intensity	candela	cd

Additional units are derived in the following ways:

Derived units can be a combination of exponentiated base units. For example, Hz (Hertz) is the unit for frequencies and is actually derived from the calculation of 1/s. A more complicated derived unit is volt (V). A volt is actually:

$$( \text{m}^2 \times \text{kg} ) / ( \text{s}^3 \times \text{A} )$$

The SI defines various derived units with their own name, for example pascal (Pa), watt (W), volt (V), and many more.

The Measurement class must maintain its unit by keeping track of the exponents of the 7 basic SI units.

If different units are used in addition or subtraction of Measurement objects, an ArithmeticException must be thrown.

```
Measurement length = new Measurement( v1, 0.01, Unit.m );
Measurement duration = new Measurement( v2, 0, Unit.s );
try {
    Measurement r = length.add( duration );
}
catch( ArithmeticException e ) {
    // This must be thrown
}
```

When two Measurement objects are multiplied, the Unit object of the result contains the sum of the exponents. When two Measurement objects are divided, the exponents of the Unit object of the result are calculated by subtraction of the exponents.

The Measurement class must support exponents of -64 to +63. Overflow must not be reported but must result in an invalid Unit object. All calculations with an invalid Unit object should result in an invalid Unit object. Typical computations generate exponents for units between +/- 4.

## 704.5.1

### Quantitative Differences

The base and derived units can be converted to other units that are of the same *quality*, but require a conversion because their scales and offsets may differ. For example, degrees Fahrenheit, kelvin, and Celsius are all temperatures and, therefore, only differ in their quantity. Kelvin and Celsius are the same scale and differ only in their starting points. Fahrenheit differs from kelvin in that both scale and starting point differ.

Using different Unit objects for the units that differ only in quantity can easily introduce serious software bugs. Therefore, the Unit class utilizes the SI units. Any exchange of measurements should be done using SI units to prevent these errors. When a measurement needs to be displayed, the presentation logic should perform the necessary conversions to present it in a localized form. For exam-

ple, when speed is presented in a car purchased in the United States, it should be presented as miles instead of meters.

## 704.5.2 Why Use SI Units

The adoption of the SI in the United States and the United Kingdom has met with resistance. This issue raises the question why the SI system has to be the preferred measurement system in the OSGi Specifications.

The SI system is utilized because it is the only measurement *system* that has a consistent set of base units. The base units can be combined to create a large number of derived units without requiring a large number of complicated conversion formulas. For example, a watt is simply a combination of meters, kilograms, and seconds ( $\text{m}^2 \times \text{kg} / \text{s}^3$ ). In contrast, horsepower is not easily related to inches, feet, fathoms, yards, furlongs, ounces, pounds, stones, or miles. This difficulty is the reason that science has utilized the SI for a long time. It is also the reason that the SI has been chosen as the system used for the Measurement class.

The purpose of the Measurement class is internal, however, and should not restrict the usability of the OSGi environment. Users should be able to use the local measurement units when data is input or displayed. This choice is the responsibility of the application developer.

## 704.6 State Object

The State object is used to represent discrete states. It contains a time-stamp but does not contain an error or Unit object. The Measurement object is not suitable to maintain discrete states. For example, a car door can be LOCKED, UNLOCKED, or CHILDLCKED. Measuring and operating with these values does not require error calculations, nor does it require SI units. Therefore, the State object is a simple, named object that holds an integer value.

## 704.7 Related Standards

### 704.7.1 GNU Math Library in Kawa

The open source project Kawa, a scheme-based Java environment, has included a `gnu.math` library that contains unit handling similar to this specification. It can be found at [4] *A Math Library containing unit handling in Kawa*.

The library seems considerably more complex without offering much more functionality than this specification. It also does not strictly separate basic SI units such as meter from quantitatively derived units such as pica.

## 704.8 Security Considerations

The Measurement, Unit and State classes have been made immutable. Instances of these classes can be freely handed out to other bundles because they cannot be extended, nor can the value, error, or time-stamp be altered after the object is created.

## 704.9 org.osgi.util.measurement

Measurement Package Version 1.0.

Bundles wishing to use this package must list the package in the Import-Package header of the bundle's manifest.

Example import for consumers using the API in this package:

```
Import-Package: org.osgi.util.measurement; version="[1.0,2.0)"
```

## 704.9.1 Summary

- Measurement - Represents a value with an error, a unit and a time-stamp.
- State - Groups a state name, value and timestamp.
- Unit - A unit system for measurements.

## 704.9.2 public class Measurement implements Comparable

Represents a value with an error, a unit and a time-stamp.

A Measurement object is used for maintaining the tuple of value, error, unit and time-stamp. The value and error are represented as doubles and the time is measured in milliseconds since midnight, January 1, 1970 UTC.

Mathematic methods are provided that correctly calculate taking the error into account. A runtime error will occur when two measurements are used in an incompatible way. E.g., when a speed (m/s) is added to a distance (m). The measurement class will correctly track changes in unit during multiplication and division, always coercing the result to the most simple form. See Unit for more information on the supported units.

Errors in the measurement class are absolute errors. Measurement errors should use the P95 rule. Actual values must fall in the range value +/- error 95% or more of the time.

A Measurement object is immutable in order to be easily shared.

Note: This class has a natural ordering that is inconsistent with equals. See compareTo(Object).

*Concurrency* Immutable

### 704.9.2.1 public Measurement(double value,double error,Unit unit,long time)

*value* The value of the Measurement.

*error* The error of the Measurement.

*unit* The Unit object in which the value is measured. If this argument is null, then the unit will be set to Unit.unity.

*time* The time measured in milliseconds since midnight, January 1, 1970 UTC.

- Create a new Measurement object.

### 704.9.2.2 public Measurement(double value,double error,Unit unit)

*value* The value of the Measurement.

*error* The error of the Measurement.

*unit* The Unit object in which the value is measured. If this argument is null, then the unit will be set to Unit.unity.

- Create a new Measurement object with a time of zero.

### 704.9.2.3 public Measurement(double value,Unit unit)

*value* The value of the Measurement.

*unit* The Unit in which the value is measured. If this argument is null, then the unit will be set to Unit.unit.

- Create a new Measurement object with an error of 0.0 and a time of zero.

#### 704.9.2.4 **public Measurement(double value)**

*value* The value of the Measurement.

- Create a new Measurement object with an error of 0.0, a unit of Unit.unit and a time of zero.

#### 704.9.2.5 **public Measurement add(Measurement m)**

*m* The Measurement object that will be added with this object.

- Returns a new Measurement object that is the sum of this object added to the specified object. The error and unit of the new object are computed. The time of the new object is set to the time of this object.

*Returns* A new Measurement object that is the sum of this and m.

*Throws* ArithmeticException— If the Unit objects of this object and the specified object cannot be added.

*See Also* Unit

#### 704.9.2.6 **public Measurement add(double d,Unit u)**

*d* The value that will be added with this object.

*u* The Unit object of the specified value.

- Returns a new Measurement object that is the sum of this object added to the specified value.

*Returns* A new Measurement object that is the sum of this object added to the specified value. The unit of the new object is computed. The error and time of the new object is set to the error and time of this object.

*Throws* ArithmeticException— If the Unit objects of this object and the specified value cannot be added.

*See Also* Unit

#### 704.9.2.7 **public Measurement add(double d)**

*d* The value that will be added with this object.

- Returns a new Measurement object that is the sum of this object added to the specified value.

*Returns* A new Measurement object that is the sum of this object added to the specified value. The error, unit, and time of the new object is set to the error, Unit and time of this object.

#### 704.9.2.8 **public int compareTo(Object obj)**

*obj* The object to be compared.

- Compares this object with the specified object for order. Returns a negative integer, zero, or a positive integer if this object is less than, equal to, or greater than the specified object.

Note: This class has a natural ordering that is inconsistent with equals. For this method, another Measurement object is considered equal if there is some  $x$  such that

$$\text{getValue}() - \text{getError}() \leq x \leq \text{getValue}() + \text{getError}()$$

for both Measurement objects being compared.

*Returns* A negative integer, zero, or a positive integer if this object is less than, equal to, or greater than the specified object.

*Throws* ClassCastException— If the specified object is not of type Measurement.

ArithmeticException– If the unit of the specified Measurement object is not equal to the Unit object of this object.

**704.9.2.9      public Measurement div(Measurement m)**

*m* The Measurement object that will be the divisor of this object.

- Returns a new Measurement object that is the quotient of this object divided by the specified object.

*Returns* A new Measurement object that is the quotient of this object divided by the specified object. The error and unit of the new object are computed. The time of the new object is set to the time of this object.

*Throws* ArithmeticException– If the Unit objects of this object and the specified object cannot be divided.

*See Also* Unit

**704.9.2.10     public Measurement div(double d,Unit u)**

*d* The value that will be the divisor of this object.

*u* The Unit object of the specified value.

- Returns a new Measurement object that is the quotient of this object divided by the specified value.

*Returns* A new Measurement that is the quotient of this object divided by the specified value. The error and unit of the new object are computed. The time of the new object is set to the time of this object.

*Throws* ArithmeticException– If the Unit objects of this object and the specified object cannot be divided.

*See Also* Unit

**704.9.2.11     public Measurement div(double d)**

*d* The value that will be the divisor of this object.

- Returns a new Measurement object that is the quotient of this object divided by the specified value.

*Returns* A new Measurement object that is the quotient of this object divided by the specified value. The error of the new object is computed. The unit and time of the new object is set to the Unit and time of this object.

**704.9.2.12     public boolean equals(Object obj)**

*obj* The object to compare with this object.

- Returns whether the specified object is equal to this object. Two Measurement objects are equal if they have same value, error and Unit.

Note: This class has a natural ordering that is inconsistent with equals. See compareTo(Object).

*Returns* true if this object is equal to the specified object; false otherwise.

**704.9.2.13     public final double getError()**

- Returns the error of this Measurement object. The error is always a positive value.

*Returns* The error of this Measurement as a double.

**704.9.2.14     public final long getTime()**

- Returns the time at which this Measurement object was taken. The time is measured in milliseconds since midnight, January 1, 1970 UTC, or zero when not defined.

*Returns* The time at which this Measurement object was taken or zero.

**704.9.2.15     public final Unit getUnit()**

- Returns the Unit object of this Measurement object.

*Returns* The Unit object of this Measurement object.

*See Also* Unit

**704.9.2.16**      **public final double getValue()**

- Returns the value of this Measurement object.

*Returns* The value of this Measurement object as a double.

**704.9.2.17**      **public int hashCode()**

- Returns a hash code value for this object.

*Returns* A hash code value for this object.

**704.9.2.18**      **public Measurement mul(Measurement m)**

*m* The Measurement object that will be multiplied with this object.

- Returns a new Measurement object that is the product of this object multiplied by the specified object.

*Returns* A new Measurement that is the product of this object multiplied by the specified object. The error and unit of the new object are computed. The time of the new object is set to the time of this object.

*Throws* ArithmeticException– If the Unit objects of this object and the specified object cannot be multiplied.

*See Also* Unit

**704.9.2.19**      **public Measurement mul(double d,Unit u)**

*d* The value that will be multiplied with this object.

*u* The Unit of the specified value.

- Returns a new Measurement object that is the product of this object multiplied by the specified value.

*Returns* A new Measurement object that is the product of this object multiplied by the specified value. The error and unit of the new object are computed. The time of the new object is set to the time of this object.

*Throws* ArithmeticException– If the units of this object and the specified value cannot be multiplied.

*See Also* Unit

**704.9.2.20**      **public Measurement mul(double d)**

*d* The value that will be multiplied with this object.

- Returns a new Measurement object that is the product of this object multiplied by the specified value.

*Returns* A new Measurement object that is the product of this object multiplied by the specified value. The error of the new object is computed. The unit and time of the new object is set to the unit and time of this object.

**704.9.2.21**      **public Measurement sub(Measurement m)**

*m* The Measurement object that will be subtracted from this object.

- Returns a new Measurement object that is the subtraction of the specified object from this object.

*Returns* A new Measurement object that is the subtraction of the specified object from this object. The error and unit of the new object are computed. The time of the new object is set to the time of this object.

*Throws* ArithmeticException– If the Unit objects of this object and the specified object cannot be subtracted.

*See Also* Unit

#### 704.9.2.22 **public Measurement sub(double d,Unit u)**

*d* The value that will be subtracted from this object.

*u* The Unit object of the specified value.

- Returns a new Measurement object that is the subtraction of the specified value from this object.

*Returns* A new Measurement object that is the subtraction of the specified value from this object. The unit of the new object is computed. The error and time of the new object is set to the error and time of this object.

*Throws* ArithmeticException– If the Unit objects of this object and the specified object cannot be subtracted.

*See Also* Unit

#### 704.9.2.23 **public Measurement sub(double d)**

*d* The value that will be subtracted from this object.

- Returns a new Measurement object that is the subtraction of the specified value from this object.

*Returns* A new Measurement object that is the subtraction of the specified value from this object. The error, unit and time of the new object is set to the error, Unit object and time of this object.

#### 704.9.2.24 **public String toString()**

- Returns a String object representing this Measurement object.

*Returns* a String object representing this Measurement object.

### 704.9.3 **public class State**

Groups a state name, value and timestamp.

The state itself is represented as an integer and the time is measured in milliseconds since midnight, January 1, 1970 UTC.

A State object is immutable so that it may be easily shared.

*Concurrency* Immutable

#### 704.9.3.1 **public State(int value,String name,long time)**

*value* The value of the state.

*name* The name of the state.

*time* The time measured in milliseconds since midnight, January 1, 1970 UTC.

- Create a new State object.

#### 704.9.3.2 **public State(int value,String name)**

*value* The value of the state.

*name* The name of the state.

- Create a new State object with a time of 0.

#### 704.9.3.3 **public boolean equals(Object obj)**

*obj* The object to compare with this object.

- Return whether the specified object is equal to this object. Two State objects are equal if they have same value and name.

*Returns* true if this object is equal to the specified object; false otherwise.

**704.9.3.4 public final String getName()**

- Returns the name of this State.

*Returns* The name of this State object.

**704.9.3.5 public final long getTime()**

- Returns the time with which this State was created.

*Returns* The time with which this State was created. The time is measured in milliseconds since midnight, January 1, 1970 UTC.

**704.9.3.6 public final int getValue()**

- Returns the value of this State.

*Returns* The value of this State object.

**704.9.3.7 public int hashCode()**

- Returns a hash code value for this object.

*Returns* A hash code value for this object.

**704.9.3.8 public String toString()**

- Returns a String object representing this object.

*Returns* a String object representing this object.

**704.9.4 public class Unit**

A unit system for measurements. This class contains definitions of the most common SI units.

This class only support exponents for the base SI units in the range -64 to +63. Any operation which produces an exponent outside of this range will result in a Unit object with undefined exponents.

*Concurrency* Immutable

**704.9.4.1 public static final Unit A**

The electric current unit ampere (A)

**704.9.4.2 public static final Unit C**

The electric charge unit coulomb (C).

coulomb is expressed in SI units as s·A

**704.9.4.3 public static final Unit cd**

The luminous intensity unit candela (cd)

**704.9.4.4 public static final Unit F**

The capacitance unit farad (F).

farad is equal to C/V or is expressed in SI units as  $s^4 \cdot A^2 / m^2 \cdot kg$

**704.9.4.5 public static final Unit Gy**

The absorbed dose unit gray (Gy).

Gy is equal to J/kg or is expressed in SI units as  $m^2/s^2$

**704.9.4.6 public static final Unit Hz**

The frequency unit hertz (Hz).



hertz is expressed in SI units as 1/s

**704.9.4.7****public static final Unit J**

The energy unit joule (J).

joule is equal to N·m or is expressed in SI units as  $\text{m}^2 \cdot \text{kg} / \text{s}^2$

**704.9.4.8****public static final Unit K**

The temperature unit kelvin (K)

**704.9.4.9****public static final Unit kat**

The catalytic activity unit katal (kat).

katal is expressed in SI units as mol/s

**704.9.4.10****public static final Unit kg**

The mass unit kilogram (kg)

**704.9.4.11****public static final Unit lx**

The illuminance unit lux (lx).

lux is expressed in SI units as  $\text{cd} / \text{m}^2$

**704.9.4.12****public static final Unit m**

The length unit meter (m)

**704.9.4.13****public static final Unit m2**

The area unit square meter ( $\text{m}^2$ )

**704.9.4.14****public static final Unit m3**

The volume unit cubic meter ( $\text{m}^3$ )

**704.9.4.15****public static final Unit m\_s**

The speed unit meter per second (m/s)

**704.9.4.16****public static final Unit m\_s2**

The acceleration unit meter per second squared ( $\text{m} / \text{s}^2$ )

**704.9.4.17****public static final Unit mol**

The amount of substance unit mole (mol)

**704.9.4.18****public static final Unit N**

The force unit newton (N).

N is expressed in SI units as  $\text{m} \cdot \text{kg} / \text{s}^2$

**704.9.4.19****public static final Unit Ohm**

The electric resistance unit ohm.

ohm is equal to V/A or is expressed in SI units as  $\text{m}^2 \cdot \text{kg} / \text{s}^3 \cdot \text{A}^2$

**704.9.4.20****public static final Unit Pa**

The pressure unit pascal (Pa).

Pa is equal to  $\text{N} / \text{m}^2$  or is expressed in SI units as  $\text{kg} / \text{m} \cdot \text{s}^2$

- 704.9.4.21 public static final Unit rad**  
The angle unit radians (rad)
- 704.9.4.22 public static final Unit s**  
The time unit second (s)
- 704.9.4.23 public static final Unit S**  
The electric conductance unit siemens (S).  
siemens is equal to A/V or is expressed in SI units as  $s^3 \cdot A^2 / m^2 \cdot kg$
- 704.9.4.24 public static final Unit T**  
The magnetic flux density unit tesla (T).  
tesla is equal to  $Wb/m^2$  or is expressed in SI units as  $kg/s^2 \cdot A$
- 704.9.4.25 public static final Unit unity**  
No Unit (Unity)
- 704.9.4.26 public static final Unit V**  
The electric potential difference unit volt (V).  
volt is equal to W/A or is expressed in SI units as  $m^2 \cdot kg/s^3 \cdot A$
- 704.9.4.27 public static final Unit W**  
The power unit watt (W).  
watt is equal to J/s or is expressed in SI units as  $m^2 \cdot kg/s^3$
- 704.9.4.28 public static final Unit Wb**  
The magnetic flux unit weber (Wb).  
weber is equal to V·s or is expressed in SI units as  $m^2 \cdot kg/s^2 \cdot A$
- 704.9.4.29 public boolean equals(Object obj)**  
*obj* the Unit object that should be checked for equality  
  - Checks whether this Unit object is equal to the specified Unit object. The Unit objects are considered equal if their exponents are equal.*Returns* true if the specified Unit object is equal to this Unit object.
- 704.9.4.30 public int hashCode()**  
  - Returns the hash code for this object.*Returns* This object's hash code.
- 704.9.4.31 public String toString()**  
  - Returns a String object representing the Unit*Returns* A String object representing the Unit

## 704.10 References

[1] *SI Units information*

- 
- <http://physics.nist.gov/cuu/Units>
- [2] *General SI index*  
<http://en.wikipedia.org/wiki/SI>
- [3] *JSR 108 Units Specification*  
<http://www.jcp.org/jsr/detail/108.jsp>
- [4] *A Math Library containing unit handling in Kawa*  
<http://www.gnu.org/software/kawa>
- [5] *Mars Polar Lander failure*  
<http://mars.jpl.nasa.gov/msp98/news/mco990930.html>



# 705 Promises Specification

## Version 1.0

### 705.1 Introduction

One of the fundamental pieces of an asynchronous programming model is the mechanism by which clients retrieve the result of the asynchronous task. Since Java 5, there has been a `java.util.concurrent.Future` interface available in the Java class libraries, which means that it is the *de facto* API in Java for handling the result of an asynchronous task. Futures have some limitations however in that they have no mechanism for registering callbacks. Java 8 introduces the class `java.util.concurrent.CompletableFuture` which addresses this but the requirement of Java 8 is unsuitable for many OSGi users at this time.

This specification defines a Promises API which can be used on many versions of Java including Java 5 and Java ME CDC/Foundation. The Promises API defined by this specification is independent of all other OSGi specifications including the OSGi Framework and thus can be easily used outside of the OSGi environment.

A Promise object holds the result of a potentially asynchronous task. The receiver of a Promise object can register callbacks on the Promise to be notified when the result is available or can block on the result becoming available. Promises can be chained together in powerful ways to handle asynchronous work flows and recovery.

Promises capture the effects of latency and errors by making these explicit in the API signatures. Latency is represented by callbacks which will eventually be called. Errors are represented by the failure member. In essence, this is what sets Promises apart from things such as RPC calls where such effects are not explicitly captured but rather attempted to be transparently handled.

#### 705.1.1 Essentials

- *Common concepts* - The API is inspired by the Promises work in JavaScript and uses the same basic concepts. See [2] *JavaScript Promises*.
- *Independent* - The design is independent of all other OSGi specifications and can be used outside of an OSGi environment.
- *Asynchronous* - The design supports asynchronous tasks.
- *Small* - The API and implementation are very compact.
- *Complete* - The design provides a very complete set of operations for Promise which are primitives that can be used to address most use cases.
- *Monad* - The design supports monadic programming. See [4] *Monad*.
- *Resolution* - A Promise can be resolved successfully with a value or unsuccessfully with an exception.
- *Generified* - Generics are used to promote type safety.

#### 705.1.2 Entities

- *Promise* - A Promise object holds the eventual result of a potentially asynchronous task.
- *Callback* - The receiver of a Promise can register callbacks on the Promise to be notified when the task is completed.

- *Deferred* - A Deferred object represents the potentially asynchronous task and is used to resolve the Promise.

Figure 705.1

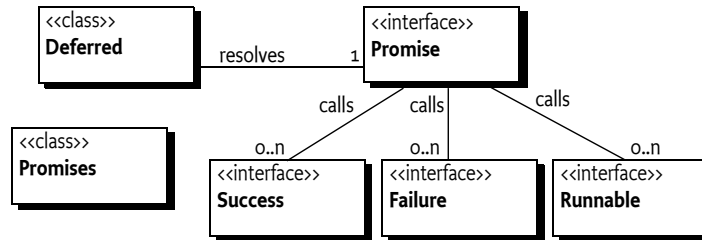
Class diagram of *org.osgi.util.promise*

## 705.2 Promise

A Promise object holds the eventual result of a potentially asynchronous task. A Promise is either unresolved or resolved. An *unresolved* Promise does not have the result of the associated task available while a *resolved* Promise has the result of the associated task available. The `isDone()` method must return true if the Promise is resolved and false if the Promise is unresolved. A Promise must only be resolved once.

A resolved Promise can be either resolved with a value, which means the associated task *completed successfully* and supplied a result, or resolved with a failure, which means the associated task *completed unsuccessfully* and supplied an exception. The `getFailure()` method can be called to determine if the resolved Promise completed successfully with a value or unsuccessfully with a failure. If the `getFailure()` method returns a Throwable, the Promise resolved unsuccessfully with a failure. If the `getFailure()` method returns null, the Promise resolved successfully with a value that can be obtained from `getValue()`.

If the Promise is unresolved, then calling `getFailure()` or `getValue()` must block until the Promise is resolved. In general, these two methods should not be used outside of a callback. Use callbacks to be notified when the Promise is resolved. See *Callbacks* on page 1139.

## 705.3 Deferred

**Promise** is an interface which can allow for many Promise implementations. This API contains the **Deferred** class which provides a standard Promise implementation. A Deferred object can be created with the `Deferred()` constructor and the Promise associated with the new Deferred object can be obtained using `getPromise()`. This Promise can then be supplied to other parties who can use it to be notified of and obtain the eventual result.

```

public Promise<String> getTimeConsumingAnswer () {
    Deferred<String> deferred = new Deferred<String> ();
    asynchronously (() -> doTask(deferred));
    return deferred.getPromise();
}
  
```

A Deferred object can later be used to resolve the associated Promise successfully by calling `resolve(T)` or unsuccessfully by calling `fail(Throwable)`.

```

private void doTask(Deferred<String> deferred) {
    try {
        String answer = computeTimeConsumingAnswer ();
    }
  }
  
```

```

        deferred.resolve(answer); // successfully resolve with value
    } catch (Exception e) {
        deferred.fail(e); // unsuccessfully resolve with exception
    }
}

```

A Deferred object can also be used to resolve the associated Promise with the eventual result of another Promise by calling `resolveWith(Promise)`.

```

private void doTask(Deferred<String> deferred) {
    try {
        Promise<String> answer = getPromiseWithTheAnswer();
        deferred.resolveWith(answer); // resolve with another Promise
    } catch (Exception e) {
        deferred.fail(e); // unsuccessfully resolve with exception
    }
}

```

If `resolve(T)` or `fail(Throwable)` is called when the Promise associated with the Deferred is already resolved, then an Illegal State Exception must be thrown.

Care must be taken in sharing a Deferred object with other parties since the other parties can resolve the associated Promise. A Deferred object should be made available only to the party that will responsible for resolving the associated Promise.

## 705.4 Callbacks

To be notified when a Promise has been resolved, callbacks are used. The Promise API provides two forms of callbacks: the basic Runnable callback and the more specialized `Success` and `Failure` callbacks.

A callback may be called on a different thread than the thread which registered the callback. So the callback must be thread safe but can rely upon that the registration of the callback *happens-before* the callback is called.

Resolving a Promise *happens-before* any registered callback is called. That is, for the resolved Promise, in a registered callback `isDone()` must return true and `getValue()` and `getFailure()` must not block.

Callbacks may be registered at any time including before and after a Promise has been resolved. If a callback is registered before the Promise is resolved, it will be called later when the Promise is resolved. If a callback is registered on an already resolved Promise, it will be called right away.

### 705.4.1 Runnable

The `onResolve(Runnable)` method is used to register a Runnable with the Promise which must be called when the Promise is resolved either successfully with a value or unsuccessfully with a failure. The resolved Promise is not passed to the Runnable, so if the Runnable implementation needs access to the resolved Promise, it must take care to ensure it has access.

```

final Promise<String> answer = getTimeConsumingAnswer();
answer.onResolve(new Runnable() {
    public void run() {
        doSomethingWithAnswer(answer);
    }
});

```

The `onResolve(Runnable)` method returns the Promise object upon which it is called.

### 705.4.2 Success and Failure

The `then(Success)` and `then(Success,Failure)` methods can be used to register the more specialized `Success` and `Failure` callbacks. The `Success` callback is only called if the Promise is successfully resolved with a value. The `Failure` callback is only called if the Promise is unsuccessfully resolved with a failure.

```
Promise<String> answer = getTimeConsumingAnswer();
answer.then(p -> processResult(p.getValue()), p -> handleFailure(p.getFailure()));
```

The `then` methods return a new Promise which can be used to chain Promises together.

## 705.5 Chaining Promises

The `then(Success)` and `then(Success,Failure)` methods also provide a means to chain Promises together. The `then` methods return a new Promise which is chained to the original Promise upon which the `then` method was called. The returned Promise must be resolved when the original Promise is resolved after the specified `Success` or `Failure` callback is executed. The result of the executed callback must be used to resolve the returned Promise. A sequence of calls to the `then` methods can be used to create a chain of promises which are resolved in sequence.

If the original Promise is successfully resolved, the `Success` callback is executed and the Promise returned by the `Success` callback, if any, or thrown exception is used to resolve the Promise returned from the `then` method. If the original Promise is resolved with a failure, the `Failure` callback is executed and the Promise returned from the `then` method is resolved with a failure.

In the following example, a Promise which will supply the name of the file to download is chained to a Promise which will return a mirror URL to use to download the file which is then further chained to a Promise which will return an Input Stream from which to read the download file.

```
Promise<String> name = getDownloadName();
Promise<URL> mirror = name.then(p -> getMirror(p.getValue()));
Promise<InputStream> in = mirror.then(p -> getStream(p.getValue()));
```

Since we probably do not need the intermediate Promises, we can collapse the chain into a single statement.

```
Promise<InputStream> in = getDownloadName().then(p -> getMirror(p.getValue()))
    .then(p -> getStream(p.getValue()));
```

The chain of Promises will also propagate any exceptions that occur to resolve the last Promise in the chain which means we do not need to do any exception handling in the intermediate tasks.

## 705.6 Monad

The Promise API supports monadic programming. See [4] *Monad*. The `Promise` interface defines a number of interesting methods including `map`, `flatMap` and `filter`.

- `filter(Predicate)` - Filter the value of the Promise.

If the Promise is successfully resolved, the predicate argument is called with the value of the Promise. If the predicate accepts the value, then the value is used to successfully resolve the Promise returned by the `filter` method. If the predicate does not accept the value, the Promise returned by the `filter` method is unsuccessfully resolved with a `No Such Element Exception`. If the predicate throws an exception, the Promise returned by the `filter` method is unsuccessfully resolved with that exception.



If the Promise is unsuccessfully resolved, the predicate argument is not called and the Promise returned by the filter method is unsuccessfully resolved with the failure of the Promise.

- [map\(Function\)](#) - Map the value of the Promise.

If the Promise is successfully resolved, the function argument is called with the value of the Promise. The value returned by the function is used to successfully resolve the Promise returned by the map method. If the function throws an exception, the Promise returned by the map method is unsuccessfully resolved with that exception.

If the Promise is unsuccessfully resolved, the function argument is not called and the Promise returned by the map method is unsuccessfully resolved with the failure of the Promise.

- [flatMap\(Function\)](#) - FlatMap the value of the Promise.

If the Promise is successfully resolved, the function argument is called with the value of the Promise. The Promise returned by the function is used to resolve the Promise returned by the flatMap method. If the function throws an exception, the Promise returned by the flatMap method is unsuccessfully resolved with that exception.

If the Promise is unsuccessfully resolved, the function argument is not called and the Promise returned by the flatMap method is unsuccessfully resolved with the failure of the Promise.

- [recover\(Function\)](#) - Recover from the unsuccessful resolution of the Promise with a recovery value.

If the Promise is successfully resolved, the function argument is not called and the Promise returned by the recover method is resolved with the value of the Promise.

If the Promise is unsuccessfully resolved, the function argument is called with the Promise to supply a recovery value. If the recovery value is not null, the Promise returned by the recover method is successfully resolved with the recovery value. If the recovery value is null, the Promise returned by the recover method is unsuccessfully resolved with the failure of the Promise. If the function throws an exception, the Promise returned by the recover method is unsuccessfully resolved with that exception.

- [recoverWith\(Function\)](#) - Recover from the unsuccessful resolution of the Promise with a recovery Promise.

If the Promise is successfully resolved, the function argument is not called and the Promise returned by the recover method is resolved with the value of the Promise.

If the Promise is unsuccessfully resolved, the function argument is called with the Promise to supply a recovery Promise. If the recovery Promise is not null, the Promise returned by the recover method is resolved with the recovery Promise. If the recovery Promise is null, the Promise returned by the recover method is unsuccessfully resolved with the failure of the Promise. If the function throws an exception, the Promise returned by the recover method is unsuccessfully resolved with that exception.

- [fallbackTo\(Promise\)](#) - Fall back to the value of the Promise argument if the Promise unsuccessfully resolves.

If the Promise is successfully resolved, the Promise argument is not used and the Promise returned by the fallbackTo method is resolved with the value of the Promise.

If the Promise is unsuccessfully resolved, the Promise argument is used to provide a fallback value when it becomes resolved. If the Promise argument is successfully resolved, the Promise returned by the fallbackTo method is resolved with the value of the Promise argument. If the Promise argument is unsuccessfully resolved, the Promise returned by the fallbackTo method is unsuccessfully resolved with the failure of the Promise.

These functions can be used to build pipelines of chained Promises that are processed in sequence. For example, in the following chain, the value of the original promise, once resolved, is filtered for

acceptable values. If the filter says the value is not acceptable, the `recover` method will be used to replace it with a default value.

```
return promise.filter(v -> isValueOk(v)).recover(p -> getDefaultValue())
```

With these chains, one can write powerful programs without the need to resort to complex if/else and try/catch logic.

## 705.7 Functional Interfaces

In Java 8, the concept of Functional Interfaces is introduced. See [5] *Function Interfaces*. Functional interfaces are interfaces with a single abstract method. Instances of functional interfaces can be created with lambda expressions, method references, or constructor references. Many methods on [Promise](#) take functional interface arguments and so are suitable for use with lambda expressions and method references in Java 8.

Two of these functional interfaces are [Function](#) and [Predicate](#). These are equivalent to functional interfaces which are part of the `java.util.function` package introduced in Java 8. Since OSGi intends the Promise API to be usable on versions of Java prior to Java 8, we define our own interfaces. In the future, if Java 8 or later, becomes the base supported Java level for this specification, OSGi can update the [Promise](#) interface to add default methods which accept the `java.util.function` versions of these functional interfaces.

## 705.8 Promises Class

The [Promises](#) class provides several useful static methods when working with Promises.

Often, you may need to create an already resolved Promise to return or chain with another Promise. The [resolved\(T\)](#) method can be used to create a new Promise already successfully resolved with the specified value. The [failed\(Throwable\)](#) method can be used to create a new Promise already unsuccessfully resolved with the specified exception.

```
return getTimeConsumingAnswer().fallbackTo(Promises.resolved("Fallback Value"));
```

The Promises class also provides the [all\(Promise...\)](#) and [all\(Collection\)](#) methods which return a new Promise that is a latch on the specified Promises. The returned Promise must resolve only when all of the specified Promises have resolved.

## 705.9 Security

The Promise API does not define any OSGi services nor does the API perform any privileged actions. Therefore, it has no security considerations.

## 705.10 org.osgi.util.promise

Promise Package Version 1.0.

Bundles wishing to use this package must list the package in the `Import-Package` header of the bundle's manifest.

Example import for consumers using the API in this package:

```
Import-Package: org.osgi.util.promise; version="[1.0,2.0)"
```

Example import for providers implementing the API in this package:

```
Import-Package: org.osgi.util.promise; version="[1.0,1.1)"
```

## 705.10.1 Summary

- Deferred - A Deferred Promise resolution.
- FailedPromisesException - Promise failure exception for a collection of failed Promises.
- Failure - Failure callback for a Promise.
- Promise - A Promise of a value.
- Promises - Static helper methods for Promises.
- Success - Success callback for a Promise.

## 705.10.2 **public class Deferred<T>**

<T> The value type associated with the created Promise.

A Deferred Promise resolution.

Instances of this class can be used to create a Promise that can be resolved in the future. The associated Promise can be successfully resolved with `resolve(Object)` or resolved with a failure with `fail(Throwable)`. It can also be resolved with the resolution of another promise using `resolveWith(Promise)`.

The associated Promise can be provided to any one, but the Deferred object should be made available only to the party that will responsible for resolving the Promise.

*Concurrency* Immutable

### 705.10.2.1 **public Deferred()**

- Create a new Deferred with an associated Promise.

### 705.10.2.2 **public void fail(Throwable failure)**

*failure* The failure of the resolved Promise. Must not be null.

- Fail the Promise associated with this Deferred.

After the associated Promise is resolved with the specified failure, all registered callbacks are called and any chained Promises are resolved.

Resolving the associated Promise *happens-before* any registered callback is called. That is, in a registered callback, `Promise.isDone()` must return true and `Promise.getValue()` and `Promise.getFailure()` must not block.

*Throws* `IllegalStateException`— If the associated Promise was already resolved.

### 705.10.2.3 **public Promise<T> getPromise()**

- Returns the Promise associated with this Deferred.

*Returns* The Promise associated with this Deferred.

### 705.10.2.4 **public void resolve(T value)**

*value* The value of the resolved Promise.

- Successfully resolve the Promise associated with this Deferred.

After the associated Promise is resolved with the specified value, all registered callbacks are called and any chained Promises are resolved.

Resolving the associated Promise *happens-before* any registered callback is called. That is, in a registered callback, Promise.isDone() must return true and Promise.getValue() and Promise.getFailure() must not block.

*Throws* IllegalStateException– If the associated Promise was already resolved.

#### 705.10.2.5 **public Promise<Void> resolveWith(Promise<? extends T> with)**

*with* A Promise whose value or failure must be used to resolve the associated Promise. Must not be null.

- Resolve the Promise associated with this Deferred with the specified Promise.

If the specified Promise is successfully resolved, the associated Promise is resolved with the value of the specified Promise. If the specified Promise is resolved with a failure, the associated Promise is resolved with the failure of the specified Promise.

After the associated Promise is resolved with the specified Promise, all registered callbacks are called and any chained Promises are resolved.

Resolving the associated Promise *happens-before* any registered callback is called. That is, in a registered callback, Promise.isDone() must return true and Promise.getValue() and Promise.getFailure() must not block.

*Returns* A Promise that is resolved only when the associated Promise is resolved by the specified Promise. The returned Promise must be successfully resolved with the value null, if the associated Promise was resolved by the specified Promise. The returned Promise must be resolved with a failure of IllegalStateException, if the associated Promise was already resolved when the specified Promise was resolved.

### 705.10.3 **public class FailedPromisesException extends RuntimeException**

Promise failure exception for a collection of failed Promises.

#### 705.10.3.1 **public FailedPromisesException(Collection<Promise<?>> failed,Throwable cause)**

*failed* A collection of Promises that have been resolved with a failure. Must not be null, must not be empty and all of the elements in the collection must not be null.

*cause* The cause of this exception. This is typically the failure of the first Promise in the specified collection.

- Create a new FailedPromisesException with the specified Promises.

#### 705.10.3.2 **public Collection<Promise<?>> getFailedPromises()**

- Returns the collection of Promises that have been resolved with a failure.

*Returns* The collection of Promises that have been resolved with a failure. The returned collection is unmodifiable.

### 705.10.4 **public interface Failure**

Failure callback for a Promise.

A Failure callback is registered with a Promise using the Promise.then(Success, Failure) method and is called if the Promise is resolved with a failure.

This is a functional interface and can be used as the assignment target for a lambda expression or method reference.

*Concurrency* Thread-safe

#### 705.10.4.1 **public void fail(Promise<?> resolved) throws Exception**

*resolved* The failed resolved Promise.

- Failure callback for a Promise.

This method is called if the Promise with which it is registered resolves with a failure.

In the remainder of this description we will refer to the Promise returned by `Promise.then(Success, Failure)` when this Failure callback was registered as the chained Promise.

If this methods completes normally, the chained Promise must be failed with the same exception which failed the resolved Promise. If this method throws an exception, the chained Promise must be failed with the thrown exception.

*Throws* Exception– The chained Promise must be failed with the thrown exception.

## 705.10.5 **public interface Promise<T>**

<T> The value type associated with this Promise.

A Promise of a value.

A Promise represents a future value. It handles the interactions for asynchronous processing. A Deferred object can be used to create a Promise and later resolve the Promise. A Promise is used by the caller of an asynchronous function to get the result or handle the error. The caller can either get a callback when the Promise is resolved with a value or an error, or the Promise can be used in chaining. In chaining, callbacks are provided that receive the resolved Promise, and a new Promise is generated that resolves based upon the result of a callback.

Both callbacks and chaining can be repeated any number of times, even after the Promise has been resolved.

Example callback usage:

```
final Promise<String> foo = foo();
foo.onResolve(new Runnable() {
    public void run() {
        System.out.println(foo.getValue());
    }
});
```

Example chaining usage;

```
Success<String,String> doubler = new Success<String,String>() {
    public Promise<String> call(Promise<String> p) throws Exception {
        return Promises.resolved(p.getValue()+p.getValue());
    }
};
final Promise<String> foo = foo().then(doubler).then(doubler);
foo.onResolve(new Runnable() {
    public void run() {
        System.out.println(foo.getValue());
    }
});
```

*Concurrency* Thread-safe

*Provider Type* Consumers of this API must not implement this type

### 705.10.5.1 **public Promise<T> fallbackTo(Promise<? extends T> fallback)**

*fallback* The Promise whose value must be used to resolve the returned Promise if this Promise resolves with a failure. Must not be null.

- Fall back to the value of the specified Promise if this Promise fails.

If this Promise is successfully resolved, the returned Promise must be resolved with the value of this Promise.

If this Promise is resolved with a failure, the successful result of the specified Promise is used to resolve the returned Promise. If the specified Promise is resolved with a failure, the returned Promise must be failed with the failure of this Promise rather than the failure of the specified Promise.

This method may be called at any time including before and after this Promise has been resolved.

*Returns* A Promise that returns the value of this Promise or falls back to the value of the specified Promise.

#### 705.10.5.2 **public Promise<T> filter(Predicate<?> predicate)**

*predicate* The Predicate to evaluate the value of this Promise. Must not be null.

- Filter the value of this Promise.

If this Promise is successfully resolved, the returned Promise must either be resolved with the value of this Promise, if the specified Predicate accepts that value, or failed with a `NoSuchElementException`, if the specified Predicate does not accept that value. If the specified Predicate throws an exception, the returned Promise must be failed with the exception.

If this Promise is resolved with a failure, the returned Promise must be failed with that failure.

This method may be called at any time including before and after this Promise has been resolved.

*Returns* A Promise that filters the value of this Promise.

#### 705.10.5.3 **public Promise<R> flatMap(Function<?,Promise<? extends R>> mapper)**

*Type Arguments* <R>

<R> The value type associated with the returned Promise.

*mapper* The Function that must flatMap the value of this Promise to a Promise that must be used to resolve the returned Promise. Must not be null.

- FlatMap the value of this Promise.

If this Promise is successfully resolved, the returned Promise must be resolved with the Promise from the specified Function as applied to the value of this Promise. If the specified Function throws an exception, the returned Promise must be failed with the exception.

If this Promise is resolved with a failure, the returned Promise must be failed with that failure.

This method may be called at any time including before and after this Promise has been resolved.

*Returns* A Promise that returns the value of this Promise as mapped by the specified Function.

#### 705.10.5.4 **public Throwable getFailure() throws InterruptedException**

- Returns the failure of this Promise.

If this Promise is not resolved, this method must block and wait for this Promise to be resolved before completing.

If this Promise was resolved with a failure, this method returns with the failure of this Promise. If this Promise was successfully resolved, this method must return null.

*Returns* The failure of this resolved Promise or null if this Promise was successfully resolved.

*Throws* `InterruptedException`– If the current thread was interrupted while waiting.

#### 705.10.5.5 **public T getValue() throws InvocationTargetException, InterruptedException**

- Returns the value of this Promise.

If this Promise is not resolved, this method must block and wait for this Promise to be resolved before completing.

If this Promise was successfully resolved, this method returns with the value of this Promise. If this Promise was resolved with a failure, this method must throw an `InvocationTargetException` with the failure exception as the cause.

*Returns* The value of this resolved Promise.

*Throws* `InvocationTargetException`– If this Promise was resolved with a failure. The cause of the `InvocationTargetException` is the failure exception.

`InterruptedException`– If the current thread was interrupted while waiting.

#### 705.10.5.6 **public boolean isDone()**

- Returns whether this Promise has been resolved.

This Promise may be successfully resolved or resolved with a failure.

*Returns* true if this Promise was resolved either successfully or with a failure; false if this Promise is unresolved.

#### 705.10.5.7 **public Promise<R> map(Function<?,? extends R> mapper)**

*Type Arguments* <R>

<R> The value type associated with the returned Promise.

*mapper* The Function that must map the value of this Promise to the value that must be used to resolve the returned Promise. Must not be null.

- Map the value of this Promise.

If this Promise is successfully resolved, the returned Promise must be resolved with the value of specified Function as applied to the value of this Promise. If the specified Function throws an exception, the returned Promise must be failed with the exception.

If this Promise is resolved with a failure, the returned Promise must be failed with that failure.

This method may be called at any time including before and after this Promise has been resolved.

*Returns* A Promise that returns the value of this Promise as mapped by the specified Function.

#### 705.10.5.8 **public Promise<T> onResolve(Runnable callback)**

*callback* A callback to be called when this Promise is resolved. Must not be null.

- Register a callback to be called when this Promise is resolved.

The specified callback is called when this Promise is resolved either successfully or with a failure.

This method may be called at any time including before and after this Promise has been resolved.

Resolving this Promise *happens-before* any registered callback is called. That is, in a registered callback, `isDone()` must return true and `getValue()` and `getFailure()` must not block.

A callback may be called on a different thread than the thread which registered the callback. So the callback must be thread safe but can rely upon that the registration of the callback *happens-before* the registered callback is called.

*Returns* This Promise.

#### 705.10.5.9 **public Promise<T> recover(Function<Promise<?>?,? extends T> recovery)**

*recovery* If this Promise resolves with a failure, the specified Function is called to produce a recovery value to be used to resolve the returned Promise. Must not be null.

- Recover from a failure of this Promise with a recovery value.

If this Promise is successfully resolved, the returned Promise must be resolved with the value of this Promise.

If this Promise is resolved with a failure, the specified Function is applied to this Promise to produce a recovery value.

- If the recovery value is not null, the returned Promise must be resolved with the recovery value.
- If the recovery value is null, the returned Promise must be failed with the failure of this Promise.
- If the specified Function throws an exception, the returned Promise must be failed with that exception.

To recover from a failure of this Promise with a recovery value of null, the `recoverWith(Function)` method must be used. The specified Function for `recoverWith(Function)` can return `Promises.resolved(null)` to supply the desired null value.

This method may be called at any time including before and after this Promise has been resolved.

*Returns* A Promise that resolves with the value of this Promise or recovers from the failure of this Promise.

#### 705.10.5.10 **public Promise<T> recoverWith(Function<Promise<?>,Promise<? extends T>> recovery)**

*recovery* If this Promise resolves with a failure, the specified Function is called to produce a recovery Promise to be used to resolve the returned Promise. Must not be null.

- Recover from a failure of this Promise with a recovery Promise.

If this Promise is successfully resolved, the returned Promise must be resolved with the value of this Promise.

If this Promise is resolved with a failure, the specified Function is applied to this Promise to produce a recovery Promise.

- If the recovery Promise is not null, the returned Promise must be resolved with the recovery Promise.
- If the recovery Promise is null, the returned Promise must be failed with the failure of this Promise.
- If the specified Function throws an exception, the returned Promise must be failed with that exception.

This method may be called at any time including before and after this Promise has been resolved.

*Returns* A Promise that resolves with the value of this Promise or recovers from the failure of this Promise.

#### 705.10.5.11 **public Promise<R> then(Success<?,? extends R> success,Failure failure)**

*Type Arguments* <R>

<R> The value type associated with the returned Promise.

*success* A Success callback to be called when this Promise is successfully resolved. May be null if no Success callback is required. In this case, the returned Promise must be resolved with the value null when this Promise is successfully resolved.

*failure* A Failure callback to be called when this Promise is resolved with a failure. May be null if no Failure callback is required.

- Chain a new Promise to this Promise with Success and Failure callbacks.

The specified Success callback is called when this Promise is successfully resolved and the specified Failure callback is called when this Promise is resolved with a failure.

This method returns a new Promise which is chained to this Promise. The returned Promise must be resolved when this Promise is resolved after the specified Success or Failure callback is executed. The result of the executed callback must be used to resolve the returned Promise. Multiple calls to this method can be used to create a chain of promises which are resolved in sequence.



If this Promise is successfully resolved, the Success callback is executed and the result Promise, if any, or thrown exception is used to resolve the returned Promise from this method. If this Promise is resolved with a failure, the Failure callback is executed and the returned Promise from this method is failed.

This method may be called at any time including before and after this Promise has been resolved.

Resolving this Promise *happens-before* any registered callback is called. That is, in a registered callback, `isDone()` must return true and `getValue()` and `getFailure()` must not block.

A callback may be called on a different thread than the thread which registered the callback. So the callback must be thread safe but can rely upon that the registration of the callback *happens-before* the registered callback is called.

*Returns* A new Promise which is chained to this Promise. The returned Promise must be resolved when this Promise is resolved after the specified Success or Failure callback, if any, is executed.

#### 705.10.5.12 **public Promise<R> then(Success<?,? extends R> success)**

*Type Arguments* <R>

<R> The value type associated with the returned Promise.

*success* A Success callback to be called when this Promise is successfully resolved. May be null if no Success callback is required. In this case, the returned Promise must be resolved with the value null when this Promise is successfully resolved.

- Chain a new Promise to this Promise with a Success callback.

This method performs the same function as calling `then(Success, Failure)` with the specified Success callback and null for the Failure callback.

*Returns* A new Promise which is chained to this Promise. The returned Promise must be resolved when this Promise is resolved after the specified Success, if any, is executed.

*See Also* `then(Success, Failure)`

### 705.10.6 **public class Promises**

Static helper methods for Promises.

*Concurrency* Thread-safe

#### 705.10.6.1 **public static Promise<List<T>> all(Collection<Promise<S>> promises)**

*Type Arguments* <T,S extends T>

<T> The value type of the List value associated with the returned Promise.

<S> A subtype of the value type of the List value associated with the returned Promise.

*promises* The Promises which must be resolved before the returned Promise must be resolved. Must not be null and all of the elements in the collection must not be null.

- Create a new Promise that is a latch on the resolution of the specified Promises.

The new Promise acts as a gate and must be resolved after all of the specified Promises are resolved.

*Returns* A Promise that is resolved only when all the specified Promises are resolved. The returned Promise must be successfully resolved with a List of the values in the order of the specified Promises if all the specified Promises are successfully resolved. The List in the returned Promise is the property of the caller and is modifiable. The returned Promise must be resolved with a failure of `FailedPromisesException` if any of the specified Promises are resolved with a failure. The failure `FailedPromisesException` must contain all of the specified Promises which resolved with a failure.

**705.10.6.2 public static Promise<List<T>> all(Promise<? extends T> ... promises)***Type Arguments* <T>

&lt;T&gt; The value type associated with the specified Promises.

*promises* The Promises which must be resolved before the returned Promise must be resolved. Must not be null and all of the arguments must not be null.

- Create a new Promise that is a latch on the resolution of the specified Promises.

The new Promise acts as a gate and must be resolved after all of the specified Promises are resolved.

*Returns* A Promise that is resolved only when all the specified Promises are resolved. The returned Promise must be successfully resolved with a List of the values in the order of the specified Promises if all the specified Promises are successfully resolved. The List in the returned Promise is the property of the caller and is modifiable. The returned Promise must be resolved with a failure of FailedPromisesException if any of the specified Promises are resolved with a failure. The failure FailedPromisesException must contain all of the specified Promises which resolved with a failure.**705.10.6.3 public static Promise<T> failed(Throwable failure)***Type Arguments* <T>

&lt;T&gt; The value type associated with the returned Promise.

*failure* The failure of the resolved Promise. Must not be null.

- Create a new Promise that has been resolved with the specified failure.

*Returns* A new Promise that has been resolved with the specified failure.**705.10.6.4 public static Promise<T> resolved(T value)***Type Arguments* <T>

&lt;T&gt; The value type associated with the returned Promise.

*value* The value of the resolved Promise.

- Create a new Promise that has been resolved with the specified value.

*Returns* A new Promise that has been resolved with the specified value.**705.10.7 public interface Success<T,R>**

&lt;T&gt; The value type of the resolved Promise passed as input to this callback.

&lt;R&gt; The value type of the returned Promise from this callback.

Success callback for a Promise.

A Success callback is registered with a Promise using the Promise.then(Success) method and is called if the Promise is resolved successfully.

This is a functional interface and can be used as the assignment target for a lambda expression or method reference.

*Concurrency* Thread-safe**705.10.7.1 public Promise<R> call(Promise<T> resolved) throws Exception***resolved* The successfully resolved Promise.

- Success callback for a Promise.

This method is called if the Promise with which it is registered resolves successfully.

In the remainder of this description we will refer to the Promise returned by this method as the returned Promise and the Promise returned by `Promise.then(Success)` when this Success callback was registered as the chained Promise.

If the returned Promise is null then the chained Promise must resolve immediately with a successful value of null. If the returned Promise is not null then the chained Promise must be resolved when the returned Promise is resolved.

*Returns* The Promise to use to resolve the chained Promise, or null if the chained Promise is to be resolved immediately with the value null.

*Throws* Exception— The chained Promise must be failed with the thrown exception.

## 705.11 org.osgi.util.function

Function Package Version 1.0.

Bundles wishing to use this package must list the package in the Import-Package header of the bundle's manifest.

Example import for consumers using the API in this package:

```
Import-Package: org.osgi.util.function; version="[1.0,2.0)"
```

Example import for providers implementing the API in this package:

```
Import-Package: org.osgi.util.function; version="[1.0,1.1)"
```

### 705.11.1 Summary

- Function - A function that accepts a single argument and produces a result.
- Predicate - A predicate that accepts a single argument and produces a boolean result.

### 705.11.2 public interface Function<T,R>

<T> The type of the function input.

<R> The type of the function output.

A function that accepts a single argument and produces a result.

This is a functional interface and can be used as the assignment target for a lambda expression or method reference.

*Concurrency* Thread-safe

#### 705.11.2.1 public R apply(T t)

*t* The input to this function.

- Applies this function to the specified argument.

*Returns* The output of this function.

### 705.11.3 public interface Predicate<T>

<T> The type of the predicate input.

A predicate that accepts a single argument and produces a boolean result.

This is a functional interface and can be used as the assignment target for a lambda expression or method reference.

*Concurrency* Thread-safe

**705.11.3.1 public boolean test(T t)**

*t* The input to this predicate.

- Evaluates this predicate on the specified argument.

*Returns* true if the specified argument is accepted by this predicate; false otherwise.

## 705.12 References

- [1] *JavaScript Promises*  
[https://developer.mozilla.org/en-US/docs/Web/JavaScript/Reference/Global\\_Objects/Promise](https://developer.mozilla.org/en-US/docs/Web/JavaScript/Reference/Global_Objects/Promise)
- [2] *JavaScript Promises*  
<http://www.html5rocks.com/en/tutorials/es6/promises/>
- [3] *ECMAScript 6 drafts*  
[http://wiki.ecmascript.org/doku.php?id=harmony:specification\\_drafts](http://wiki.ecmascript.org/doku.php?id=harmony:specification_drafts)
- [4] *Monad*  
[https://en.wikipedia.org/wiki/Monad\\_%28functional\\_programming%29](https://en.wikipedia.org/wiki/Monad_%28functional_programming%29)
- [5] *Function Interfaces*  
<http://docs.oracle.com/javase/specs/jls/se8/html/jls-9.html#jls-9.8>

# 999 Execution Environment Specification

*Version 1.3*

## 999.1 Introduction

This specification defines two different execution environments for OSGi Server Platform Servers. One is based on a minimal environment that supports OSGi Framework and basic services implementations. The other is derived from [6] *Foundation Profile*. Care has been taken to make the minimum requirements a proper subset of Foundation Profile.

This chapter contains a detailed listing of the Execution Environments. This list is the actual specification and is normative. However, this list is not suited for tools. Therefore, the OSGi web site provides the JAR files that contain all the signatures of the Execution Environments on the OSGi web site, see [2] *Downloadable Execution Environments*.

Please note that the OSGi Minimum Execution Requirements do not constitute a specification for a Java technology profile or platform under the Java Community Process, but rather are a list of dependencies on certain elements of the presumed underlying Java profile(s) or platform(s).

### 999.1.1 Essentials

- *Bundle Environment* - A well defined format with handling rules for defining the classes and methods that a bundle can rely on.
- *Machine Processable* - It should be easy to process the specification with tools to verify bundles and Frameworks.
- *Standards* - It should be based on standards as much as possible. It must be compatible with [3] *J2ME, Java 2 Micro Edition*.

### 999.1.2 Entities

- *Execution Environment* - A collection of classes.
- *Class* - Contains a set of qualifiers and a set of signature for each method and field in that class.
- *Signature* - A unique identifier for the type associated with a field or the return type and argument types of a function.
- *Qualifiers* - A set of attributes that further define a signature.
- *Profile* - A SUN/JCP defined set of classes, based on a configuration.
- *Configuration* - A SUN/JCP defined set of classes and VM specification.

Figure 999.1 Entities involved in an Execution Environment

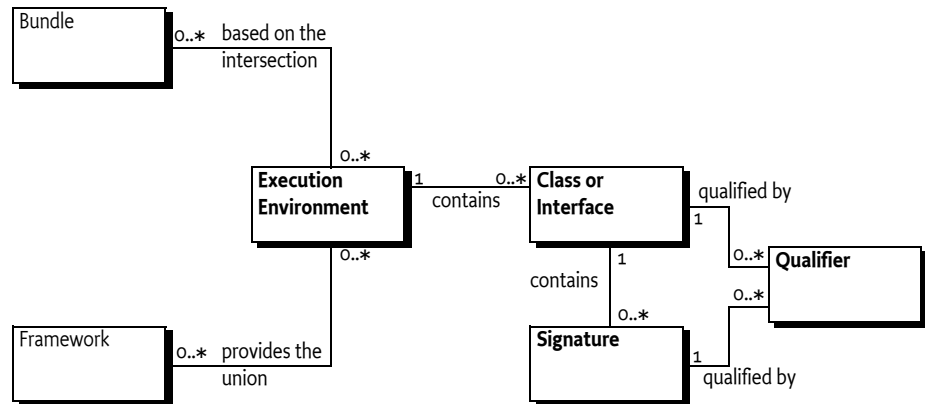

## 999.2 About Execution Environments

### 999.2.1 Signatures

An Execution Environment consists of a set of public and protected *signatures*. A signature is defined to be a unique identifier for a field or method with class and type information. For example, the signature of the `wait(long)` method in `Object` would be:

```
java/lang/Object.wait(J)V
```

The encoding of the signature is defined in [1] *The Java Virtual Machine Specification*.

For this specification, each signature includes a set of *qualifiers* that further qualify the field or method. These are the access qualifiers (like `public`, `private`, and `protected`), and informational qualifiers like `synchronized`, `volatile`, `strictfp`, `interface`, `native`, and `abstract`. These informational qualifiers are not included in the EE listings.

An Execution Environment consists of a set of classes and interfaces with their access qualifiers. Each class consist of a set of signatures.

### 999.2.2 Semantics

An Execution environment is solely based on the signatures of the methods and fields. An OSGi Execution Environment relies on the appropriate SUN Java documents to define the semantics of a methods or fields.

## 999.3 OSGi Defined Execution Environments

This specification contains two Execution Environments. They are listed in the following sections. Each signature is printed in the normal Java format except that public modifiers are not shown to save space (all fields or methods must be public or protected to be included in this list).

Before each signature there are two columns.

1. OSGi/Minimum-1.2 execution requirements
2. CDC-1.1/Foundation-1.1 execution environment.

If the column contains a  $\blacksquare$ , it means that the signature has been *included* in that Execution Environment. A  $\square$  indicates that the signature is missing from the EE.

The information is included here for completeness. However, it is likely that tools will be developed by vendors that validate the compliance of Frameworks and bundles in relation to an Execution Environment. For that reason, it is possible to download a JAR file containing all the signatures as Java class files from the OSGi web site, see [2] *Downloadable Execution Environments*.

## 999.3.1 java.io

■■ package java.io	
■■ class <b>BufferedInputStream</b> extends <b>FilterInputStream</b>	
■■ BufferedInputStream(InputStream)	■■ protected int marklimit
■■ BufferedInputStream(InputStream,int)	■■ protected int markpos
■■ protected byte[] buf	■■ protected int pos
■■ protected int count	
■■ class <b>BufferedOutputStream</b> extends <b>FilterOutputStream</b>	
■■ BufferedOutputStream(OutputStream)	■■ protected byte[] buf
■■ BufferedOutputStream(OutputStream,int)	■■ protected int count
■■ class <b>BufferedReader</b> extends <b>Reader</b>	
■■ BufferedReader(Reader)	■■ int read(char[],int,int) throws IOException
■■ BufferedReader(Reader,int)	■■ String readLine() throws IOException
■■ void close() throws IOException	
■■ class <b>BufferedWriter</b> extends <b>Writer</b>	
■■ BufferedWriter(Writer)	■■ void flush() throws IOException
■■ BufferedWriter(Writer,int)	■■ void newLine() throws IOException
■■ void close() throws IOException	■■ void write(char[],int,int) throws IOException
■■ class <b>ByteArrayInputStream</b> extends <b>InputStream</b>	
■■ ByteArrayInputStream(byte[])	■■ protected int pos
■■ ByteArrayInputStream(byte[],int,int)	■■ int read()
■■ int available()	■■ int read(byte[],int,int)
■■ protected byte[] buf	■■ void reset()
■■ protected int count	■■ long skip(long)
■■ protected int mark	
■■ class <b>ByteArrayOutputStream</b> extends <b>OutputStream</b>	
■■ ByteArrayOutputStream()	■■ byte[] toByteArray()
■■ ByteArrayOutputStream(int)	■■ String toString(String) throws UnsupportedOperationException
■■ protected byte[] buf	■■ void write(byte[],int,int)
■■ protected int count	■■ void write(int)
■■ void reset()	■■ void writeTo(OutputStream) throws IOException
■■ int size()	
■■ class <b>CharArrayReader</b> extends <b>Reader</b>	
■■ CharArrayReader(char[])	■■ protected int count
■■ CharArrayReader(char[],int,int)	■■ protected int markPos
■■ protected char[] buf	■■ protected int pos
■■ void close()	■■ int read(char[],int,int) throws IOException
■■ class <b>CharArrayWriter</b> extends <b>Writer</b>	
■■ CharArrayWriter()	■■ int size()
■■ CharArrayWriter(int)	■■ char[] toCharArray()
■■ protected char[] buf	■■ void write(char[],int,int)
■■ void close()	■■ void write(int)
■■ protected int count	■■ void write(String,int,int)
■■ void flush()	■■ void writeTo(Writer) throws IOException
■■ void reset()	
■■ class <b>CharConversionException</b> extends <b>IOException</b>	
■■ CharConversionException()	■■ CharConversionException(String)
■■ interface <b>DataInput</b>	
■■ abstract boolean readBoolean() throws IOException	■■ abstract String readLine() throws IOException
■■ abstract byte readByte() throws IOException	■■ abstract long readLong() throws IOException
■■ abstract char readChar() throws IOException	■■ abstract short readShort() throws IOException
■■ abstract double readDouble() throws IOException	■■ abstract int readUnsignedByte() throws IOException
■■ abstract float readFloat() throws IOException	■■ abstract int readUnsignedShort() throws IOException
■■ abstract void readFully(byte[]) throws IOException	■■ abstract String readUTF() throws IOException
■■ abstract void readFully(byte[],int,int) throws IOException	■■ abstract int skipBytes(int) throws IOException
■■ abstract int readInt() throws IOException	
■■ class <b>DataInputStream</b> extends <b>FilterInputStream</b> implements <b>DataInput</b>	

<ul style="list-style-type: none"> <li>■ ■ DataInputStream(InputStream)</li> <li>■ ■ final int read(byte[]) throws IOException</li> <li>■ ■ final int read(byte[],int,int) throws IOException</li> <li>■ ■ final boolean readBoolean() throws IOException</li> <li>■ ■ final byte readByte() throws IOException</li> <li>■ ■ final char readChar() throws IOException</li> <li>■ ■ final double readDouble() throws IOException</li> <li>■ ■ final float readFloat() throws IOException</li> <li>■ ■ final void readFully(byte[]) throws IOException</li> <li>■ ■ final void readFully(byte[],int,int) throws IOException</li> </ul>	<ul style="list-style-type: none"> <li>■ ■ final int readInt() throws IOException</li> <li>■ ■ final String readLine() throws IOException</li> <li>■ ■ final long readLong() throws IOException</li> <li>■ ■ final short readShort() throws IOException</li> <li>■ ■ final int readUnsignedByte() throws IOException</li> <li>■ ■ final int readUnsignedShort() throws IOException</li> <li>■ ■ final String readUTF() throws IOException</li> <li>■ ■ final static String readUTF(DataInput) throws IOException</li> <li>■ ■ final int skipBytes(int) throws IOException</li> </ul>
<ul style="list-style-type: none"> <li>■ ■ <b>interface DataOutput</b></li> <li>■ ■ abstract void write(byte[]) throws IOException</li> <li>■ ■ abstract void write(byte[],int,int) throws IOException</li> <li>■ ■ abstract void write(int) throws IOException</li> <li>■ ■ abstract void writeBoolean(boolean) throws IOException</li> <li>■ ■ abstract void writeByte(int) throws IOException</li> <li>■ ■ abstract void writeBytes(String) throws IOException</li> <li>■ ■ abstract void writeChar(int) throws IOException</li> </ul>	<ul style="list-style-type: none"> <li>■ ■ abstract void writeChars(String) throws IOException</li> <li>■ ■ abstract void writeDouble(double) throws IOException</li> <li>■ ■ abstract void writeFloat(float) throws IOException</li> <li>■ ■ abstract void writeInt(int) throws IOException</li> <li>■ ■ abstract void writeLong(long) throws IOException</li> <li>■ ■ abstract void writeShort(int) throws IOException</li> <li>■ ■ abstract void writeUTF(String) throws IOException</li> </ul>
<ul style="list-style-type: none"> <li>■ ■ <b>class DataOutputStream extends FilterOutputStream implements DataOutput</b></li> <li>■ ■ DataOutputStream(OutputStream)</li> <li>■ ■ final int size()</li> <li>■ ■ final void writeBoolean(boolean) throws IOException</li> <li>■ ■ final void writeByte(int) throws IOException</li> <li>■ ■ final void writeBytes(String) throws IOException</li> <li>■ ■ final void writeChar(int) throws IOException</li> <li>■ ■ final void writeChars(String) throws IOException</li> </ul>	<ul style="list-style-type: none"> <li>■ ■ final void writeDouble(double) throws IOException</li> <li>■ ■ final void writeFloat(float) throws IOException</li> <li>■ ■ final void writeInt(int) throws IOException</li> <li>■ ■ final void writeLong(long) throws IOException</li> <li>■ ■ final void writeShort(int) throws IOException</li> <li>■ ■ final void writeUTF(String) throws IOException</li> <li>■ ■ protected int written</li> </ul>
<ul style="list-style-type: none"> <li>■ ■ <b>class EOFException extends IOException</b></li> <li>■ ■ EOFException()</li> </ul>	<ul style="list-style-type: none"> <li>■ ■ EOFException(String)</li> </ul>
<ul style="list-style-type: none"> <li>■ ■ <b>interface Externalizable extends Serializable</b></li> <li>■ ■ abstract void readExternal(ObjectInput) throws IOException, ClassNotFoundException</li> </ul>	<ul style="list-style-type: none"> <li>■ ■ abstract void writeExternal(ObjectOutput) throws IOException</li> </ul>
<ul style="list-style-type: none"> <li>■ ■ <b>class File implements Serializable , Comparable</b></li> <li>■ ■ File(File,String)</li> <li>■ ■ File(String)</li> <li>■ ■ File(String,String)</li> <li>■ ■ File(java.net.URI)</li> <li>■ ■ boolean canRead()</li> <li>■ ■ boolean canWrite()</li> <li>■ ■ int compareTo(File)</li> <li>■ ■ int compareTo(Object)</li> <li>■ ■ boolean createNewFile() throws IOException</li> <li>■ ■ static File createTempFile(String,String) throws IOException</li> <li>■ ■ static File createTempFile(String,String,File) throws IOException</li> <li>■ ■ boolean delete()</li> <li>■ ■ void deleteOnExit()</li> <li>■ ■ boolean exists()</li> <li>■ ■ File getAbsoluteFile()</li> <li>■ ■ String getAbsolutePath()</li> <li>■ ■ File getCanonicalFile() throws IOException</li> <li>■ ■ String getCanonicalPath() throws IOException</li> <li>■ ■ String getName()</li> <li>■ ■ String getParent()</li> <li>■ ■ File getParentFile()</li> <li>■ ■ String getPath()</li> <li>■ ■ boolean isAbsolute()</li> </ul>	<ul style="list-style-type: none"> <li>■ ■ boolean isDirectory()</li> <li>■ ■ boolean isFile()</li> <li>■ ■ boolean isHidden()</li> <li>■ ■ long lastModified()</li> <li>■ ■ long length()</li> <li>■ ■ String[] list()</li> <li>■ ■ String[] list(FilenameFilter)</li> <li>■ ■ File[] listFiles()</li> <li>■ ■ File[] listFiles(FileFilter)</li> <li>■ ■ File[] listFiles(FilenameFilter)</li> <li>■ ■ static File[] listRoots()</li> <li>■ ■ boolean mkdir()</li> <li>■ ■ boolean mkdirs()</li> <li>■ ■ final static String pathSeparator</li> <li>■ ■ final static char pathSeparatorChar</li> <li>■ ■ boolean renameTo(File)</li> <li>■ ■ final static String separator</li> <li>■ ■ final static char separatorChar</li> <li>■ ■ boolean setLastModified(long)</li> <li>■ ■ boolean setReadOnly()</li> <li>■ ■ java.net.URI toURI()</li> <li>■ ■ java.net.URL toURL() throws java.net.MalformedURLException</li> </ul>
<ul style="list-style-type: none"> <li>■ ■ <b>final class FileDescriptor</b></li> <li>■ ■ FileDescriptor()</li> <li>■ ■ final static FileDescriptor err</li> <li>■ ■ final static FileDescriptor in</li> </ul>	<ul style="list-style-type: none"> <li>■ ■ final static FileDescriptor out</li> <li>■ ■ void sync() throws SyncFailedException</li> <li>■ ■ boolean valid()</li> </ul>
<ul style="list-style-type: none"> <li>■ ■ <b>interface FileFilter</b></li> <li>■ ■ abstract boolean accept(File)</li> </ul>	
<ul style="list-style-type: none"> <li>■ ■ <b>class FileInputStream extends InputStream</b></li> <li>■ ■ FileInputStream(File) throws FileNotFoundException</li> <li>■ ■ FileInputStream(FileDescriptor)</li> <li>■ ■ FileInputStream(String) throws FileNotFoundException</li> </ul>	<ul style="list-style-type: none"> <li>■ ■ protected void finalize() throws IOException</li> <li>■ ■ final FileDescriptor getFD() throws IOException</li> <li>■ ■ int read() throws IOException</li> </ul>
<ul style="list-style-type: none"> <li>■ ■ <b>interface FilenameFilter</b></li> <li>■ ■ abstract boolean accept(File,String)</li> </ul>	
<ul style="list-style-type: none"> <li>■ ■ <b>class FileNotFoundException extends IOException</b></li> <li>■ ■ FileNotFoundException()</li> </ul>	<ul style="list-style-type: none"> <li>■ ■ FileNotFoundException(String)</li> </ul>
<ul style="list-style-type: none"> <li>■ ■ <b>class FileOutputStream extends OutputStream</b></li> </ul>	



<ul style="list-style-type: none"> <li>■ ■ FileOutputStream(File) throws FileNotFoundException</li> <li>■ ■ FileOutputStream(File,boolean) throws FileNotFoundException</li> <li>■ ■ FileOutputStream(FileDescriptor)</li> <li>■ ■ FileOutputStream(String) throws FileNotFoundException</li> </ul>	<ul style="list-style-type: none"> <li>■ ■ FileOutputStream(String,boolean) throws FileNotFoundException</li> <li>■ ■ protected void finalize() throws IOException</li> <li>■ ■ final FileDescriptor getFD() throws IOException</li> <li>■ ■ void write(int) throws IOException</li> </ul>
<p>■ ■ <b>final class FilePermission extends java.security.Permission implements Serializable</b></p>	
<ul style="list-style-type: none"> <li>■ ■ FilePermission(String,String)</li> <li>■ ■ boolean equals(Object)</li> <li>■ ■ String getActions()</li> </ul>	<ul style="list-style-type: none"> <li>■ ■ int hashCode()</li> <li>■ ■ boolean implies(java.security.Permission)</li> </ul>
<p>■ ■ <b>class FileReader extends InputStreamReader</b></p>	
<ul style="list-style-type: none"> <li>■ ■ FileReader(File) throws FileNotFoundException</li> <li>■ ■ FileReader(FileDescriptor)</li> </ul>	<ul style="list-style-type: none"> <li>■ ■ FileReader(String) throws FileNotFoundException</li> </ul>
<p>■ ■ <b>class FileWriter extends OutputStreamWriter</b></p>	
<ul style="list-style-type: none"> <li>■ ■ FileWriter(File) throws IOException</li> <li>■ ■ FileWriter(File,boolean) throws IOException</li> <li>■ ■ FileWriter(FileDescriptor)</li> </ul>	<ul style="list-style-type: none"> <li>■ ■ FileWriter(String) throws IOException</li> <li>■ ■ FileWriter(String,boolean) throws IOException</li> </ul>
<p>■ ■ <b>class FilterInputStream extends InputStream</b></p>	
<ul style="list-style-type: none"> <li>■ ■ protected FilterInputStream(InputStream)</li> <li>■ ■ protected InputStream in</li> </ul>	<ul style="list-style-type: none"> <li>■ ■ int read() throws IOException</li> </ul>
<p>■ ■ <b>class FilterOutputStream extends OutputStream</b></p>	
<ul style="list-style-type: none"> <li>■ ■ FilterOutputStream(OutputStream)</li> <li>■ ■ protected OutputStream out</li> </ul>	<ul style="list-style-type: none"> <li>■ ■ void write(int) throws IOException</li> </ul>
<p>■ ■ <b>abstract class FilterReader extends Reader</b></p>	
<ul style="list-style-type: none"> <li>■ ■ protected FilterReader(Reader)</li> <li>■ ■ void close() throws IOException</li> </ul>	<ul style="list-style-type: none"> <li>■ ■ protected Reader in</li> <li>■ ■ int read(char[],int,int) throws IOException</li> </ul>
<p>■ ■ <b>abstract class FilterWriter extends Writer</b></p>	
<ul style="list-style-type: none"> <li>■ ■ protected FilterWriter(Writer)</li> <li>■ ■ void close() throws IOException</li> <li>■ ■ void flush() throws IOException</li> </ul>	<ul style="list-style-type: none"> <li>■ ■ protected Writer out</li> <li>■ ■ void write(char[],int,int) throws IOException</li> </ul>
<p>■ ■ <b>abstract class InputStream</b></p>	
<ul style="list-style-type: none"> <li>■ ■ InputStream()</li> <li>■ ■ int available() throws IOException</li> <li>■ ■ void close() throws IOException</li> <li>■ ■ void mark(int)</li> <li>■ ■ boolean markSupported()</li> </ul>	<ul style="list-style-type: none"> <li>■ ■ abstract int read() throws IOException</li> <li>■ ■ int read(byte[]) throws IOException</li> <li>■ ■ int read(byte[],int,int) throws IOException</li> <li>■ ■ void reset() throws IOException</li> <li>■ ■ long skip(long) throws IOException</li> </ul>
<p>■ ■ <b>class InputStreamReader extends Reader</b></p>	
<ul style="list-style-type: none"> <li>■ ■ InputStreamReader(InputStream)</li> <li>■ ■ InputStreamReader(InputStream,String)</li> <li>throws UnsupportedOperationException</li> <li>■ ■ void close() throws IOException</li> </ul>	<ul style="list-style-type: none"> <li>■ ■ String getEncoding()</li> <li>■ ■ int read(char[],int,int) throws IOException</li> </ul>
<p>■ ■ <b>class InterruptedIOException extends IOException</b></p>	
<ul style="list-style-type: none"> <li>■ ■ InterruptedIOException()</li> <li>■ ■ InterruptedIOException(String)</li> </ul>	<ul style="list-style-type: none"> <li>■ ■ int bytesTransferred</li> </ul>
<p>■ ■ <b>class InvalidClassException extends ObjectStreamException</b></p>	
<ul style="list-style-type: none"> <li>■ ■ InvalidClassException(String)</li> <li>■ ■ InvalidClassException(String,String)</li> </ul>	<ul style="list-style-type: none"> <li>■ ■ String classname</li> </ul>
<p>■ ■ <b>class InvalidObjectException extends ObjectStreamException</b></p>	
<ul style="list-style-type: none"> <li>■ ■ InvalidObjectException(String)</li> </ul>	
<p>■ ■ <b>class IOException extends Exception</b></p>	
<ul style="list-style-type: none"> <li>■ ■ IOException()</li> </ul>	<ul style="list-style-type: none"> <li>■ ■ IOException(String)</li> </ul>
<p>■ ■ <b>class LineNumberReader extends BufferedReader</b></p>	
<ul style="list-style-type: none"> <li>■ ■ LineNumberReader(Reader)</li> <li>■ ■ LineNumberReader(Reader,int)</li> </ul>	<ul style="list-style-type: none"> <li>■ ■ int getLineNumber()</li> <li>■ ■ void setLineNumber(int)</li> </ul>
<p>■ ■ <b>class NotActiveException extends ObjectStreamException</b></p>	
<ul style="list-style-type: none"> <li>■ ■ NotActiveException()</li> </ul>	<ul style="list-style-type: none"> <li>■ ■ NotActiveException(String)</li> </ul>
<p>■ ■ <b>class NotSerializableException extends ObjectStreamException</b></p>	
<ul style="list-style-type: none"> <li>■ ■ NotSerializableException()</li> </ul>	<ul style="list-style-type: none"> <li>■ ■ NotSerializableException(String)</li> </ul>
<p>■ ■ <b>interface ObjectInput extends DataInput</b></p>	
<ul style="list-style-type: none"> <li>■ ■ abstract int available() throws IOException</li> <li>■ ■ abstract void close() throws IOException</li> <li>■ ■ abstract int read() throws IOException</li> <li>■ ■ abstract int read(byte[]) throws IOException</li> </ul>	<ul style="list-style-type: none"> <li>■ ■ abstract int read(byte[],int,int) throws IOException</li> <li>■ ■ abstract Object readObject() throws IOException, ClassNotFoundException</li> <li>■ ■ abstract long skip(long) throws IOException</li> </ul>
<p>■ ■ <b>class ObjectInputStream extends InputStream implements ObjectInput , ObjectStreamConstants</b></p>	

<ul style="list-style-type: none"> <li>■ ■ protected <code>ObjectInputStream()</code> throws <code>IOException</code></li> <li>■ ■ <code>ObjectInputStream(InputStream)</code> throws <code>IOException</code></li> <li>■ ■ void <code>defaultReadObject()</code> throws <code>IOException</code>, <code>ClassNotFoundException</code></li> <li>■ ■ protected boolean <code>enableResolveObject(boolean)</code></li> <li>■ ■ int <code>read()</code> throws <code>IOException</code></li> <li>■ ■ boolean <code>readBoolean()</code> throws <code>IOException</code></li> <li>■ ■ byte <code>readByte()</code> throws <code>IOException</code></li> <li>■ ■ char <code>readChar()</code> throws <code>IOException</code></li> <li>■ ■ protected <code>ObjectStreamClass readClassDescriptor()</code> throws <code>IOException</code>, <code>ClassNotFoundException</code></li> <li>■ ■ double <code>readDouble()</code> throws <code>IOException</code></li> <li>■ ■ <code>ObjectInputStream.GetField readFields()</code> throws <code>IOException</code>, <code>ClassNotFoundException</code></li> <li>■ ■ float <code>readFloat()</code> throws <code>IOException</code></li> <li>■ ■ void <code>readFully(byte[])</code> throws <code>IOException</code></li> <li>■ ■ void <code>readFully(byte[],int,int)</code> throws <code>IOException</code></li> <li>■ ■ int <code>readInt()</code> throws <code>IOException</code></li> </ul>	<ul style="list-style-type: none"> <li>■ ■ <code>String readLine()</code> throws <code>IOException</code></li> <li>■ ■ long <code>readLong()</code> throws <code>IOException</code></li> <li>■ ■ final <code>Object readObject()</code> throws <code>IOException</code>, <code>ClassNotFoundException</code></li> <li>■ ■ protected <code>Object readObjectOverride()</code> throws <code>IOException</code>, <code>ClassNotFoundException</code></li> <li>■ ■ short <code>readShort()</code> throws <code>IOException</code></li> <li>■ ■ protected void <code>readStreamHeader()</code> throws <code>IOException</code></li> <li>■ ■ <code>Object readUnshared()</code> throws <code>IOException</code>, <code>ClassNotFoundException</code></li> <li>■ ■ int <code>readUnsignedByte()</code> throws <code>IOException</code></li> <li>■ ■ int <code>readUnsignedShort()</code> throws <code>IOException</code></li> <li>■ ■ <code>String readUTF()</code> throws <code>IOException</code></li> <li>■ ■ void <code>registerValidation(ObjectInputValidation,int)</code> throws <code>InvalidObjectException</code>, <code>NotActiveException</code></li> <li>■ ■ protected <code>Class resolveClass(ObjectStreamClass)</code> throws <code>IOException</code>, <code>ClassNotFoundException</code></li> <li>■ ■ protected <code>Object resolveObject(Object)</code> throws <code>IOException</code></li> <li>■ ■ protected <code>Class resolveProxyClass(String[])</code> throws <code>IOException</code>, <code>ClassNotFoundException</code></li> <li>■ ■ int <code>skipBytes(int)</code> throws <code>IOException</code></li> </ul>
<ul style="list-style-type: none"> <li>■ ■ <b>abstract class <code>ObjectInputStream.GetField</code></b></li> <li>■ ■ <code>ObjectInputStream.GetField()</code></li> <li>■ ■ abstract boolean <code>defaulted(String)</code> throws <code>IOException</code></li> <li>■ ■ abstract byte <code>get(String,byte)</code> throws <code>IOException</code></li> <li>■ ■ abstract char <code>get(String,char)</code> throws <code>IOException</code></li> <li>■ ■ abstract double <code>get(String,double)</code> throws <code>IOException</code></li> <li>■ ■ abstract float <code>get(String,float)</code> throws <code>IOException</code></li> </ul>	<ul style="list-style-type: none"> <li>■ ■ abstract int <code>get(String,int)</code> throws <code>IOException</code></li> <li>■ ■ abstract long <code>get(String,long)</code> throws <code>IOException</code></li> <li>■ ■ abstract <code>Object get(String,Object)</code> throws <code>IOException</code></li> <li>■ ■ abstract short <code>get(String,short)</code> throws <code>IOException</code></li> <li>■ ■ abstract boolean <code>get(String,boolean)</code> throws <code>IOException</code></li> <li>■ ■ abstract <code>ObjectStreamClass getObjectStreamClass()</code></li> </ul>
<ul style="list-style-type: none"> <li>■ ■ <b>interface <code>ObjectInputValidation</code></b></li> <li>■ ■ abstract void <code>validateObject()</code> throws <code>InvalidObjectException</code></li> </ul>	
<ul style="list-style-type: none"> <li>■ ■ <b>interface <code>ObjectOutput</code> extends <code>DataOutput</code></b></li> <li>■ ■ abstract void <code>close()</code> throws <code>IOException</code></li> <li>■ ■ abstract void <code>flush()</code> throws <code>IOException</code></li> </ul>	<ul style="list-style-type: none"> <li>■ ■ abstract void <code>writeObject(Object)</code> throws <code>IOException</code></li> </ul>
<ul style="list-style-type: none"> <li>■ ■ <b>class <code>ObjectOutputStream</code> extends <code>OutputStream</code> implements <code>ObjectOutput</code> , <code>ObjectStreamConstants</code></b></li> <li>■ ■ protected <code>ObjectOutputStream()</code> throws <code>IOException</code></li> <li>■ ■ <code>ObjectOutputStream(OutputStream)</code> throws <code>IOException</code></li> <li>■ ■ protected void <code>annotateClass(Class)</code> throws <code>IOException</code></li> <li>■ ■ protected void <code>annotateProxyClass(Class)</code> throws <code>IOException</code></li> <li>■ ■ void <code>defaultWriteObject()</code> throws <code>IOException</code></li> <li>■ ■ protected void <code>drain()</code> throws <code>IOException</code></li> <li>■ ■ protected boolean <code>enableReplaceObject(boolean)</code></li> <li>■ ■ <code>ObjectOutputStream.PutField putFields()</code> throws <code>IOException</code></li> <li>■ ■ protected <code>Object replaceObject(Object)</code> throws <code>IOException</code></li> <li>■ ■ void <code>reset()</code> throws <code>IOException</code></li> <li>■ ■ void <code>useProtocolVersion(int)</code> throws <code>IOException</code></li> <li>■ ■ void <code>write(int)</code> throws <code>IOException</code></li> <li>■ ■ void <code>writeBoolean(boolean)</code> throws <code>IOException</code></li> <li>■ ■ void <code>writeByte(int)</code> throws <code>IOException</code></li> <li>■ ■ void <code>writeBytes(String)</code> throws <code>IOException</code></li> </ul>	<ul style="list-style-type: none"> <li>■ ■ void <code>writeChar(int)</code> throws <code>IOException</code></li> <li>■ ■ void <code>writeChars(String)</code> throws <code>IOException</code></li> <li>■ ■ protected void <code>writeClassDescriptor(ObjectStreamClass)</code> throws <code>IOException</code></li> <li>■ ■ void <code>writeDouble(double)</code> throws <code>IOException</code></li> <li>■ ■ void <code>writeFields()</code> throws <code>IOException</code></li> <li>■ ■ void <code>writeFloat(float)</code> throws <code>IOException</code></li> <li>■ ■ void <code>writeInt(int)</code> throws <code>IOException</code></li> <li>■ ■ void <code>writeLong(long)</code> throws <code>IOException</code></li> <li>■ ■ final void <code>writeObject(Object)</code> throws <code>IOException</code></li> <li>■ ■ protected void <code>writeObjectOverride(Object)</code> throws <code>IOException</code></li> <li>■ ■ void <code>writeShort(int)</code> throws <code>IOException</code></li> <li>■ ■ protected void <code>writeStreamHeader()</code> throws <code>IOException</code></li> <li>■ ■ void <code>writeUnshared(Object)</code> throws <code>IOException</code></li> <li>■ ■ void <code>writeUTF(String)</code> throws <code>IOException</code></li> </ul>
<ul style="list-style-type: none"> <li>■ ■ <b>abstract class <code>ObjectOutputStream.PutField</code></b></li> <li>■ ■ <code>ObjectOutputStream.PutField()</code></li> <li>■ ■ abstract void <code>put(String,byte)</code></li> <li>■ ■ abstract void <code>put(String,char)</code></li> <li>■ ■ abstract void <code>put(String,double)</code></li> <li>■ ■ abstract void <code>put(String,float)</code></li> <li>■ ■ abstract void <code>put(String,int)</code></li> </ul>	<ul style="list-style-type: none"> <li>■ ■ abstract void <code>put(String,long)</code></li> <li>■ ■ abstract void <code>put(String,Object)</code></li> <li>■ ■ abstract void <code>put(String,short)</code></li> <li>■ ■ abstract void <code>put(String,boolean)</code></li> <li>■ ■ abstract void <code>write(ObjectOutput)</code> throws <code>IOException</code></li> </ul>
<ul style="list-style-type: none"> <li>■ ■ <b>class <code>ObjectStreamClass</code> implements <code>Serializable</code></b></li> <li>■ ■ <code>Class forClass()</code></li> <li>■ ■ <code>ObjectStreamField getField(String)</code></li> <li>■ ■ <code>ObjectStreamField[] getFields()</code></li> <li>■ ■ <code>String getName()</code></li> </ul>	<ul style="list-style-type: none"> <li>■ ■ long <code>getSerialVersionUID()</code></li> <li>■ ■ static <code>ObjectStreamClass lookup(Class)</code></li> <li>■ ■ final static <code>ObjectStreamField[] NO_FIELDS</code></li> </ul>
<ul style="list-style-type: none"> <li>■ ■ <b>interface <code>ObjectStreamConstants</code></b></li> </ul>	

<ul style="list-style-type: none"> <li>■ final static int baseWireHandle</li> <li>■ final static int PROTOCOL_VERSION_1</li> <li>■ final static int PROTOCOL_VERSION_2</li> <li>■ final static byte SC_BLOCK_DATA</li> <li>■ final static byte SC_EXTERNALIZABLE</li> <li>■ final static byte SC_SERIALIZABLE</li> <li>■ final static byte SC_WRITE_METHOD</li> <li>■ final static short STREAM_MAGIC</li> <li>■ final static short STREAM_VERSION</li> <li>■ final static SerializablePermission SUBCLASS_IMPLEMENTATION_PERMISSION</li> <li>■ final static SerializablePermission SUBSTITUTION_PERMISSION</li> <li>■ final static byte TC_ARRAY</li> <li>■ final static byte TC_BASE</li> <li>■ final static byte TC_BLOCKDATA</li> </ul>	<ul style="list-style-type: none"> <li>■ final static byte TC_BLOCKDATALONG</li> <li>■ final static byte TC_CLASS</li> <li>■ final static byte TC_CLASSDESC</li> <li>■ final static byte TC_ENDBLOCKDATA</li> <li>■ final static byte TC_EXCEPTION</li> <li>■ final static byte TC_LONGSTRING</li> <li>■ final static byte TC_MAX</li> <li>■ final static byte TC_NULL</li> <li>■ final static byte TC_OBJECT</li> <li>■ final static byte TC_PROXYCLASSDESC</li> <li>■ final static byte TC_REFERENCE</li> <li>■ final static byte TC_RESET</li> <li>■ final static byte TC_STRING</li> </ul>
<ul style="list-style-type: none"> <li>■ <b>abstract class ObjectStreamException extends IOException</b></li> <li>■ protected ObjectStreamException()</li> </ul>	<ul style="list-style-type: none"> <li>■ protected ObjectStreamException(String)</li> </ul>
<ul style="list-style-type: none"> <li>■ <b>class ObjectStreamField implements Comparable</b></li> <li>■ ObjectStreamField(String,Class)</li> <li>■ ObjectStreamField(String,Class,boolean)</li> <li>■ int compareTo(Object)</li> <li>■ String getName()</li> <li>■ int getOffset()</li> </ul>	<ul style="list-style-type: none"> <li>■ Class getType()</li> <li>■ char getTypeCode()</li> <li>■ String getTypeString()</li> <li>■ boolean isPrimitive()</li> <li>■ protected void setOffset(int)</li> </ul>
<ul style="list-style-type: none"> <li>■ <b>class OptionalDataException extends ObjectStreamException</b></li> <li>■ boolean eof</li> </ul>	<ul style="list-style-type: none"> <li>■ int length</li> </ul>
<ul style="list-style-type: none"> <li>■ <b>abstract class OutputStream</b></li> <li>■ OutputStream()</li> <li>■ void close() throws IOException</li> <li>■ void flush() throws IOException</li> </ul>	<ul style="list-style-type: none"> <li>■ void write(byte[]) throws IOException</li> <li>■ void write(byte[],int,int) throws IOException</li> <li>■ abstract void write(int) throws IOException</li> </ul>
<ul style="list-style-type: none"> <li>■ <b>class OutputStreamWriter extends Writer</b></li> <li>■ OutputStreamWriter(OutputStream)</li> <li>■ OutputStreamWriter(OutputStream,String)</li> <li>throws UnsupportedEncodingException</li> <li>■ void close() throws IOException</li> </ul>	<ul style="list-style-type: none"> <li>■ void flush() throws IOException</li> <li>■ String getEncoding()</li> <li>■ void write(char[],int,int) throws IOException</li> </ul>
<ul style="list-style-type: none"> <li>■ <b>class PipedInputStream extends InputStream</b></li> <li>■ PipedInputStream()</li> <li>■ PipedInputStream(PipedOutputStream) throws IOException</li> <li>■ protected byte[] buffer</li> <li>■ void connect(PipedOutputStream) throws IOException</li> <li>■ protected int in</li> </ul>	<ul style="list-style-type: none"> <li>■ protected int out</li> <li>■ final protected static int PIPE_SIZE</li> <li>■ int read() throws IOException</li> <li>■ protected void receive(int) throws IOException</li> </ul>
<ul style="list-style-type: none"> <li>■ <b>class PipedOutputStream extends OutputStream</b></li> <li>■ PipedOutputStream()</li> <li>■ PipedOutputStream(PipedInputStream) throws IOException</li> </ul>	<ul style="list-style-type: none"> <li>■ void connect(PipedInputStream) throws IOException</li> <li>■ void write(int) throws IOException</li> </ul>
<ul style="list-style-type: none"> <li>■ <b>class PipedReader extends Reader</b></li> <li>■ PipedReader()</li> <li>■ PipedReader(PipedWriter) throws IOException</li> <li>■ void close() throws IOException</li> </ul>	<ul style="list-style-type: none"> <li>■ void connect(PipedWriter) throws IOException</li> <li>■ int read(char[],int,int) throws IOException</li> </ul>
<ul style="list-style-type: none"> <li>■ <b>class PipedWriter extends Writer</b></li> <li>■ PipedWriter()</li> <li>■ PipedWriter(PipedReader) throws IOException</li> <li>■ void close() throws IOException</li> </ul>	<ul style="list-style-type: none"> <li>■ void connect(PipedReader) throws IOException</li> <li>■ void flush() throws IOException</li> <li>■ void write(char[],int,int) throws IOException</li> </ul>
<ul style="list-style-type: none"> <li>■ <b>class PrintStream extends FilterOutputStream</b></li> <li>■ PrintStream(OutputStream)</li> <li>■ PrintStream(OutputStream,boolean)</li> <li>■ PrintStream(OutputStream,boolean,String)</li> <li>throws UnsupportedEncodingException</li> <li>■ boolean checkError()</li> <li>■ void close()</li> <li>■ void flush()</li> <li>■ void print(char[])</li> <li>■ void print(char)</li> <li>■ void print(double)</li> <li>■ void print(float)</li> <li>■ void print(int)</li> <li>■ void print(long)</li> <li>■ void print(Object)</li> <li>■ void print(String)</li> </ul>	<ul style="list-style-type: none"> <li>■ void print(boolean)</li> <li>■ void println()</li> <li>■ void println(char[])</li> <li>■ void println(char)</li> <li>■ void println(double)</li> <li>■ void println(float)</li> <li>■ void println(int)</li> <li>■ void println(long)</li> <li>■ void println(Object)</li> <li>■ void println(String)</li> <li>■ void println(boolean)</li> <li>■ protected void setError()</li> <li>■ void write(byte[],int,int)</li> <li>■ void write(int)</li> </ul>
<ul style="list-style-type: none"> <li>■ <b>class PrintWriter extends Writer</b></li> </ul>	

<ul style="list-style-type: none"> <li>■ ■ <code>PrintWriter(OutputStream)</code></li> <li>■ ■ <code>PrintWriter(OutputStream,boolean)</code></li> <li>■ ■ <code>PrintWriter(Writer)</code></li> <li>■ ■ <code>PrintWriter(Writer,boolean)</code></li> <li>■ ■ <code>boolean checkError()</code></li> <li>■ ■ <code>void close()</code></li> <li>■ ■ <code>void flush()</code></li> <li>■ ■ <code>protected Writer out</code></li> <li>■ ■ <code>void print(char[])</code></li> <li>■ ■ <code>void print(char)</code></li> <li>■ ■ <code>void print(double)</code></li> <li>■ ■ <code>void print(float)</code></li> <li>■ ■ <code>void print(int)</code></li> <li>■ ■ <code>void print(long)</code></li> <li>■ ■ <code>void print(Object)</code></li> <li>■ ■ <code>void print(String)</code></li> <li>■ ■ <code>void print(boolean)</code></li> </ul>	<ul style="list-style-type: none"> <li>■ ■ <code>void println()</code></li> <li>■ ■ <code>void println(char[])</code></li> <li>■ ■ <code>void println(char)</code></li> <li>■ ■ <code>void println(double)</code></li> <li>■ ■ <code>void println(float)</code></li> <li>■ ■ <code>void println(int)</code></li> <li>■ ■ <code>void println(long)</code></li> <li>■ ■ <code>void println(Object)</code></li> <li>■ ■ <code>void println(String)</code></li> <li>■ ■ <code>void println(boolean)</code></li> <li>■ ■ <code>protected void setError()</code></li> <li>■ ■ <code>void write(char[])</code></li> <li>■ ■ <code>void write(char[],int,int)</code></li> <li>■ ■ <code>void write(int)</code></li> <li>■ ■ <code>void write(String)</code></li> <li>■ ■ <code>void write(String,int,int)</code></li> </ul>
<ul style="list-style-type: none"> <li>■ ■ <b>class <code>PushbackInputStream</code> extends <code>FilterInputStream</code></b></li> <li>■ ■ <code>PushbackInputStream(InputStream)</code></li> <li>■ ■ <code>PushbackInputStream(InputStream,int)</code></li> <li>■ ■ <code>protected byte[] buf</code></li> <li>■ ■ <code>protected int pos</code></li> </ul>	<ul style="list-style-type: none"> <li>■ ■ <code>void unread(byte[]) throws IOException</code></li> <li>■ ■ <code>void unread(byte[],int,int) throws IOException</code></li> <li>■ ■ <code>void unread(int) throws IOException</code></li> </ul>
<ul style="list-style-type: none"> <li>■ ■ <b>class <code>PushbackReader</code> extends <code>FilterReader</code></b></li> <li>■ ■ <code>PushbackReader(Reader)</code></li> <li>■ ■ <code>PushbackReader(Reader,int)</code></li> <li>■ ■ <code>void unread(char[]) throws IOException</code></li> </ul>	<ul style="list-style-type: none"> <li>■ ■ <code>void unread(char[],int,int) throws IOException</code></li> <li>■ ■ <code>void unread(int) throws IOException</code></li> </ul>
<ul style="list-style-type: none"> <li>■ ■ <b>class <code>RandomAccessFile</code> implements <code>DataInput</code> , <code>DataOutput</code></b></li> <li>■ ■ <code>RandomAccessFile(File,String) throws FileNotFoundException</code></li> <li>■ ■ <code>RandomAccessFile(String,String) throws FileNotFoundException</code></li> <li>■ ■ <code>void close() throws IOException</code></li> <li>■ ■ <code>final FileDescriptor getFD() throws IOException</code></li> <li>■ ■ <code>long getFilePointer() throws IOException</code></li> <li>■ ■ <code>long length() throws IOException</code></li> <li>■ ■ <code>int read() throws IOException</code></li> <li>■ ■ <code>int read(byte[]) throws IOException</code></li> <li>■ ■ <code>int read(byte[],int,int) throws IOException</code></li> <li>■ ■ <code>final boolean readBoolean() throws IOException</code></li> <li>■ ■ <code>final byte readByte() throws IOException</code></li> <li>■ ■ <code>final char readChar() throws IOException</code></li> <li>■ ■ <code>final double readDouble() throws IOException</code></li> <li>■ ■ <code>final float readFloat() throws IOException</code></li> <li>■ ■ <code>final void readFully(byte[]) throws IOException</code></li> <li>■ ■ <code>final void readFully(byte[],int,int) throws IOException</code></li> <li>■ ■ <code>final int readInt() throws IOException</code></li> <li>■ ■ <code>final String readLine() throws IOException</code></li> <li>■ ■ <code>final long readLong() throws IOException</code></li> <li>■ ■ <code>final short readShort() throws IOException</code></li> </ul>	<ul style="list-style-type: none"> <li>■ ■ <code>final int readUnsignedByte() throws IOException</code></li> <li>■ ■ <code>final int readUnsignedShort() throws IOException</code></li> <li>■ ■ <code>final String readUTF() throws IOException</code></li> <li>■ ■ <code>void seek(long) throws IOException</code></li> <li>■ ■ <code>void setLength(long) throws IOException</code></li> <li>■ ■ <code>int skipBytes(int) throws IOException</code></li> <li>■ ■ <code>void write(byte[]) throws IOException</code></li> <li>■ ■ <code>void write(byte[],int,int) throws IOException</code></li> <li>■ ■ <code>void write(int) throws IOException</code></li> <li>■ ■ <code>final void writeBoolean(boolean) throws IOException</code></li> <li>■ ■ <code>final void writeByte(int) throws IOException</code></li> <li>■ ■ <code>final void writeBytes(String) throws IOException</code></li> <li>■ ■ <code>final void writeChar(int) throws IOException</code></li> <li>■ ■ <code>final void writeChars(String) throws IOException</code></li> <li>■ ■ <code>final void writeDouble(double) throws IOException</code></li> <li>■ ■ <code>final void writeFloat(float) throws IOException</code></li> <li>■ ■ <code>final void writeInt(int) throws IOException</code></li> <li>■ ■ <code>final void writeLong(long) throws IOException</code></li> <li>■ ■ <code>final void writeShort(int) throws IOException</code></li> <li>■ ■ <code>final void writeUTF(String) throws IOException</code></li> </ul>
<ul style="list-style-type: none"> <li>■ ■ <b>abstract class <code>Reader</code></b></li> <li>■ ■ <code>protected Reader()</code></li> <li>■ ■ <code>protected Reader(Object)</code></li> <li>■ ■ <code>abstract void close() throws IOException</code></li> <li>■ ■ <code>protected Object lock</code></li> <li>■ ■ <code>void mark(int) throws IOException</code></li> <li>■ ■ <code>boolean markSupported()</code></li> </ul>	<ul style="list-style-type: none"> <li>■ ■ <code>int read() throws IOException</code></li> <li>■ ■ <code>int read(char[]) throws IOException</code></li> <li>■ ■ <code>abstract int read(char[],int,int) throws IOException</code></li> <li>■ ■ <code>boolean ready() throws IOException</code></li> <li>■ ■ <code>void reset() throws IOException</code></li> <li>■ ■ <code>long skip(long) throws IOException</code></li> </ul>
<ul style="list-style-type: none"> <li>■ ■ <b>class <code>SequenceInputStream</code> extends <code>InputStream</code></b></li> <li>■ ■ <code>SequenceInputStream(InputStream,InputStream)</code></li> <li>■ ■ <code>SequenceInputStream(java.util.Enumeration)</code></li> </ul>	<ul style="list-style-type: none"> <li>■ ■ <code>int read() throws IOException</code></li> </ul>
<ul style="list-style-type: none"> <li>■ ■ <b>interface <code>Serializable</code></b></li> </ul>	
<ul style="list-style-type: none"> <li>■ ■ <b>final class <code>SerializablePermission</code> extends <code>java.security.BasicPermission</code></b></li> <li>■ ■ <code>SerializablePermission(String)</code></li> <li>■ ■ <code>SerializablePermission(String,String)</code></li> </ul>	
<ul style="list-style-type: none"> <li>■ ■ <b>class <code>StreamCorruptedException</code> extends <code>ObjectStreamException</code></b></li> <li>■ ■ <code>StreamCorruptedException()</code></li> <li>■ ■ <code>StreamCorruptedException(String)</code></li> </ul>	
<ul style="list-style-type: none"> <li>■ ■ <b>class <code>StreamTokenizer</code></b></li> </ul>	

<ul style="list-style-type: none"> <li>■ StreamTokenizer(Reader)</li> <li>■ void commentChar(int)</li> <li>■ void eollsSignificant(boolean)</li> <li>■ int lineno()</li> <li>■ void lowerCaseMode(boolean)</li> <li>■ int nextToken() throws IOException</li> <li>■ double nval</li> <li>■ void ordinaryChar(int)</li> <li>■ void ordinaryChars(int,int)</li> <li>■ void parseNumbers()</li> <li>■ void pushBack()</li> <li>■ void quoteChar(int)</li> </ul>	<ul style="list-style-type: none"> <li>■ void resetSyntax()</li> <li>■ void slashSlashComments(boolean)</li> <li>■ void slashStarComments(boolean)</li> <li>■ String sval</li> <li>■ final static int TT_EOF</li> <li>■ final static int TT_EOL</li> <li>■ final static int TT_NUMBER</li> <li>■ final static int TT_WORD</li> <li>■ int ttype</li> <li>■ void whitespaceChars(int,int)</li> <li>■ void wordChars(int,int)</li> </ul>
<ul style="list-style-type: none"> <li>■ <b>class StringReader extends Reader</b></li> <li>■ StringReader(String)</li> <li>■ void close()</li> </ul>	<ul style="list-style-type: none"> <li>■ int read(char[],int,int) throws IOException</li> </ul>
<ul style="list-style-type: none"> <li>■ <b>class StringWriter extends Writer</b></li> <li>■ StringWriter()</li> <li>■ StringWriter(int)</li> <li>■ void close() throws IOException</li> <li>■ void flush()</li> <li>■ StringBuffer getBuffer()</li> </ul>	<ul style="list-style-type: none"> <li>■ void write(char[],int,int)</li> <li>■ void write(int)</li> <li>■ void write(String)</li> <li>■ void write(String,int,int)</li> </ul>
<ul style="list-style-type: none"> <li>■ <b>class SyncFailedException extends IOException</b></li> <li>■ SyncFailedException(String)</li> </ul>	
<ul style="list-style-type: none"> <li>■ <b>class UnsupportedEncodingException extends IOException</b></li> <li>■ UnsupportedEncodingException()</li> </ul>	<ul style="list-style-type: none"> <li>■ UnsupportedEncodingException(String)</li> </ul>
<ul style="list-style-type: none"> <li>■ <b>class UTFDataFormatException extends IOException</b></li> <li>■ UTFDataFormatException()</li> </ul>	<ul style="list-style-type: none"> <li>■ UTFDataFormatException(String)</li> </ul>
<ul style="list-style-type: none"> <li>■ <b>class WriteAbortedException extends ObjectStreamException</b></li> <li>■ WriteAbortedException(String,Exception)</li> </ul>	<ul style="list-style-type: none"> <li>■ Exception detail</li> </ul>
<ul style="list-style-type: none"> <li>■ <b>abstract class Writer</b></li> <li>■ protected Writer()</li> <li>■ protected Writer(Object)</li> <li>■ abstract void close() throws IOException</li> <li>■ abstract void flush() throws IOException</li> <li>■ protected Object lock</li> </ul>	<ul style="list-style-type: none"> <li>■ void write(char[]) throws IOException</li> <li>■ abstract void write(char[],int,int) throws IOException</li> <li>■ void write(int) throws IOException</li> <li>■ void write(String) throws IOException</li> <li>■ void write(String,int,int) throws IOException</li> </ul>

999.3.2

java.lang

<ul style="list-style-type: none"> <li>■ <b>package java.lang</b></li> <li>■ <b>class AbstractMethodError extends IncompatibleClassChangeError</b></li> <li>■ AbstractMethodError()</li> </ul>	<ul style="list-style-type: none"> <li>■ AbstractMethodError(String)</li> </ul>
<ul style="list-style-type: none"> <li>■ <b>class ArithmeticException extends RuntimeException</b></li> <li>■ ArithmeticException()</li> </ul>	<ul style="list-style-type: none"> <li>■ ArithmeticException(String)</li> </ul>
<ul style="list-style-type: none"> <li>■ <b>class ArrayIndexOutOfBoundsException extends IndexOutOfBoundsException</b></li> <li>■ ArrayIndexOutOfBoundsException()</li> <li>■ ArrayIndexOutOfBoundsException(int)</li> </ul>	<ul style="list-style-type: none"> <li>■ ArrayIndexOutOfBoundsException(String)</li> </ul>
<ul style="list-style-type: none"> <li>■ <b>class ArrayStoreException extends RuntimeException</b></li> <li>■ ArrayStoreException()</li> </ul>	<ul style="list-style-type: none"> <li>■ ArrayStoreException(String)</li> </ul>
<ul style="list-style-type: none"> <li>■ <b>class AssertionError extends Error</b></li> <li>■ AssertionError()</li> <li>■ AssertionError(char)</li> <li>■ AssertionError(double)</li> <li>■ AssertionError(float)</li> </ul>	<ul style="list-style-type: none"> <li>■ AssertionError(int)</li> <li>■ AssertionError(long)</li> <li>■ AssertionError(Object)</li> <li>■ AssertionError(boolean)</li> </ul>
<ul style="list-style-type: none"> <li>■ <b>final class Boolean implements java.io.Serializable</b></li> <li>■ Boolean(String)</li> <li>■ Boolean(boolean)</li> <li>■ boolean booleanValue()</li> <li>■ final static Boolean FALSE</li> <li>■ static boolean getBoolean(String)</li> </ul>	<ul style="list-style-type: none"> <li>■ static String toString(boolean)</li> <li>■ final static Boolean TRUE</li> <li>■ final static Class TYPE</li> <li>■ static Boolean valueOf(String)</li> <li>■ static Boolean valueOf(boolean)</li> </ul>
<ul style="list-style-type: none"> <li>■ <b>final class Byte extends Number implements Comparable</b></li> <li>■ Byte(byte)</li> <li>■ Byte(String)</li> <li>■ int compareTo(Byte)</li> <li>■ int compareTo(Object)</li> <li>■ static Byte decode(String)</li> <li>■ double doubleValue()</li> <li>■ float floatValue()</li> <li>■ int intValue()</li> <li>■ long longValue()</li> </ul>	<ul style="list-style-type: none"> <li>■ final static byte MAX_VALUE</li> <li>■ final static byte MIN_VALUE</li> <li>■ static byte parseByte(String)</li> <li>■ static byte parseByte(String,int)</li> <li>■ static String toString(byte)</li> <li>■ final static Class TYPE</li> <li>■ static Byte valueOf(String)</li> <li>■ static Byte valueOf(String,int)</li> </ul>
<ul style="list-style-type: none"> <li>■ <b>final class Character implements java.io.Serializable , Comparable</b></li> </ul>	

- ■ Character(char)
- ■ char charValue()
- ■ final static byte COMBINING\_SPACING\_MARK
- ■ int compareTo(Character)
- ■ int compareTo(Object)
- ■ final static byte CONNECTOR\_PUNCTUATION
- ■ final static byte CONTROL
- ■ final static byte CURRENCY\_SYMBOL
- ■ final static byte DASH\_PUNCTUATION
- ■ final static byte DECIMAL\_DIGIT\_NUMBER
- ■ static int digit(char,int)
- ■ final static byte DIRECTIONALITY\_ARABIC\_NUMBER
- ■ final static byte DIRECTIONALITY\_BOUNDARY\_NEUTRAL
- ■ final static byte DIRECTIONALITY\_COMMON\_NUMBER\_SEPARATOR
- ■ final static byte DIRECTIONALITY\_EUROPEAN\_NUMBER
- ■ final static byte DIRECTIONALITY\_EUROPEAN\_NUMBER\_SEPARATOR
- ■ final static byte
- DIRECTIONALITY\_EUROPEAN\_NUMBER\_TERMINATOR
- ■ final static byte DIRECTIONALITY\_LEFT\_TO\_RIGHT
- ■ final static byte DIRECTIONALITY\_LEFT\_TO\_RIGHT\_EMBEDDING
- ■ final static byte DIRECTIONALITY\_LEFT\_TO\_RIGHT\_OVERRIDE
- ■ final static byte DIRECTIONALITY\_NONSPACING\_MARK
- ■ final static byte DIRECTIONALITY\_OTHER\_NEUTRALS
- ■ final static byte DIRECTIONALITY\_PARAGRAPH\_SEPARATOR
- ■ final static byte DIRECTIONALITY\_POP\_DIRECTIONAL\_FORMAT
- ■ final static byte DIRECTIONALITY\_RIGHT\_TO\_LEFT
- ■ final static byte DIRECTIONALITY\_RIGHT\_TO\_LEFT\_ARABIC
- ■ final static byte DIRECTIONALITY\_RIGHT\_TO\_LEFT\_EMBEDDING
- ■ final static byte DIRECTIONALITY\_RIGHT\_TO\_LEFT\_OVERRIDE
- ■ final static byte DIRECTIONALITY\_SEGMENT\_SEPARATOR
- ■ final static byte DIRECTIONALITY\_UNDEFINED
- ■ final static byte DIRECTIONALITY\_WHITESPACE
- ■ final static byte ENCLOSING\_MARK
- ■ final static byte END\_PUNCTUATION
- ■ final static byte FINAL\_QUOTE\_PUNCTUATION
- ■ static char forDigit(int,int)
- ■ final static byte FORMAT
- ■ static byte getDirectionality(char)
- ■ static int getNumericValue(char)
- ■ static int getType(char)
- ■ final static byte INITIAL\_QUOTE\_PUNCTUATION
- ■ static boolean isDefined(char)
- ■ static boolean isDigit(char)
- ■ **class Character.Subset**
- ■ protected Character.Subset(String)
- ■ final boolean equals(Object)
- ■ **final class Character.UnicodeBlock extends Character.Subset**
- ■ static boolean isIdentifierIgnorable(char)
- ■ static boolean isISOControl(char)
- ■ static boolean isJavalIdentifierPart(char)
- ■ static boolean isJavalIdentifierStart(char)
- ■ static boolean isLetter(char)
- ■ static boolean isLetterOrDigit(char)
- ■ static boolean isLowerCase(char)
- ■ static boolean isMirrored(char)
- ■ static boolean isSpaceChar(char)
- ■ static boolean isTitleCase(char)
- ■ static boolean isUnicodeIdentifierPart(char)
- ■ static boolean isUnicodeIdentifierStart(char)
- ■ static boolean isUpperCase(char)
- ■ static boolean isWhitespace(char)
- ■ final static byte LETTER\_NUMBER
- ■ final static byte LINE\_SEPARATOR
- ■ final static byte LOWERCASE\_LETTER
- ■ final static byte MATH\_SYMBOL
- ■ final static int MAX\_RADIX
- ■ final static char MAX\_VALUE
- ■ final static int MIN\_RADIX
- ■ final static char MIN\_VALUE
- ■ final static byte MODIFIER\_LETTER
- ■ final static byte MODIFIER\_SYMBOL
- ■ final static byte NON\_SPACING\_MARK
- ■ final static byte OTHER\_LETTER
- ■ final static byte OTHER\_NUMBER
- ■ final static byte OTHER\_PUNCTUATION
- ■ final static byte OTHER\_SYMBOL
- ■ final static byte PARAGRAPH\_SEPARATOR
- ■ final static byte PRIVATE\_USE
- ■ final static byte SPACE\_SEPARATOR
- ■ final static byte START\_PUNCTUATION
- ■ final static byte SURROGATE
- ■ final static byte TITLECASE\_LETTER
- ■ static char toLowerCase(char)
- ■ static String toString(char)
- ■ static char toTitleCase(char)
- ■ static char toUpperCase(char)
- ■ final static Class TYPE
- ■ final static byte UNASSIGNED
- ■ final static byte UPPERCASE\_LETTER
- ■ final int hashCode()
- ■ final String toString()

- ■ final static Character.UnicodeBlock ALPHABETIC\_PRESENTATION\_FORMS
- ■ final static Character.UnicodeBlock ARABIC
- ■ final static Character.UnicodeBlock ARABIC\_PRESENTATION\_FORMS\_A
- ■ final static Character.UnicodeBlock ARABIC\_PRESENTATION\_FORMS\_B
- ■ final static Character.UnicodeBlock ARMENIAN
- ■ final static Character.UnicodeBlock ARROWS
- ■ final static Character.UnicodeBlock BASIC\_LATIN
- ■ final static Character.UnicodeBlock BENGALI
- ■ final static Character.UnicodeBlock BLOCK\_ELEMENTS
- ■ final static Character.UnicodeBlock BOPOMOFO
- ■ final static Character.UnicodeBlock BOPOMOFO\_EXTENDED
- ■ final static Character.UnicodeBlock BOX\_DRAWING
- ■ final static Character.UnicodeBlock BRAILLE\_PATTERNS
- ■ final static Character.UnicodeBlock CHEROKEE
- ■ final static Character.UnicodeBlock CJK\_COMPATIBILITY
- ■ final static Character.UnicodeBlock CJK\_COMPATIBILITY\_FORMS
- ■ final static Character.UnicodeBlock CJK\_COMPATIBILITY\_IDEOGRAPHS
- ■ final static Character.UnicodeBlock CJK\_RADICALS\_SUPPLEMENT
- ■ final static Character.UnicodeBlock CJK\_SYMBOLS\_AND\_PUNCTUATION
- ■ final static Character.UnicodeBlock CJK\_UNIFIED\_IDEOGRAPHS
- ■ final static Character.UnicodeBlock CJK\_UNIFIED\_IDEOGRAPHS\_EXTENSION\_A
- ■ final static Character.UnicodeBlock COMBINING\_DIACRITICAL\_MARKS
- ■ final static Character.UnicodeBlock COMBINING\_HALF\_MARKS
- ■ final static Character.UnicodeBlock COMBINING\_MARKS\_FOR\_SYMBOLS
- ■ final static Character.UnicodeBlock CONTROL\_PICTURES
- ■ final static Character.UnicodeBlock CURRENCY\_SYMBOLS
- ■ final static Character.UnicodeBlock CYRILLIC
- ■ final static Character.UnicodeBlock DEVANAGARI
- ■ final static Character.UnicodeBlock DINGBATS
- ■ final static Character.UnicodeBlock ENCLOSED\_ALPHANUMERICS
- ■ final static Character.UnicodeBlock ENCLOSED\_CJK\_LETTERS\_AND\_MONTHS
- ■ final static Character.UnicodeBlock ETHIOPIA
- ■ final static Character.UnicodeBlock GENERAL\_PUNCTUATION
- ■ final static Character.UnicodeBlock GEOMETRIC\_SHAPES
- ■ final static Character.UnicodeBlock GEORGIAN
- ■ final static Character.UnicodeBlock GREEK
- ■ final static Character.UnicodeBlock GREEK\_EXTENDED
- ■ final static Character.UnicodeBlock GUJARATI
- ■ final static Character.UnicodeBlock GURMUKHI
- ■ final static Character.UnicodeBlock HALFWIDTH\_AND\_FULLWIDTH\_FORMS
- ■ final static Character.UnicodeBlock HANGUL\_COMPATIBILITY\_JAMO
- ■ final static Character.UnicodeBlock HANGUL\_JAMO
- ■ final static Character.UnicodeBlock HANGUL\_SYLLABLES
- ■ **interface CharSequence**
- ■ abstract char charAt(int)
- ■ abstract int length()
- ■ **final class Class implements java.io.Serializable**
- ■ final static Character.UnicodeBlock HEBREW
- ■ final static Character.UnicodeBlock HIRAGANA
- ■ final static Character.UnicodeBlock IDEOGRAPHIC\_DESCRIPTION\_CHARACTERS
- ■ final static Character.UnicodeBlock IPA\_EXTENSIONS
- ■ final static Character.UnicodeBlock KANBUN
- ■ final static Character.UnicodeBlock KANGXI\_RADICALS
- ■ final static Character.UnicodeBlock KANNADA
- ■ final static Character.UnicodeBlock KATAKANA
- ■ final static Character.UnicodeBlock KHMER
- ■ final static Character.UnicodeBlock LAO
- ■ final static Character.UnicodeBlock LATIN\_1\_SUPPLEMENT
- ■ final static Character.UnicodeBlock LATIN\_EXTENDED\_A
- ■ final static Character.UnicodeBlock LATIN\_EXTENDED\_ADDITIONAL
- ■ final static Character.UnicodeBlock LATIN\_EXTENDED\_B
- ■ final static Character.UnicodeBlock LETTERLIKE\_SYMBOLS
- ■ final static Character.UnicodeBlock MALAYALAM
- ■ final static Character.UnicodeBlock MATHEMATICAL\_OPERATORS
- ■ final static Character.UnicodeBlock MISCELLANEOUS\_SYMBOLS
- ■ final static Character.UnicodeBlock MISCELLANEOUS\_TECHNICAL
- ■ final static Character.UnicodeBlock MONGOLIAN
- ■ final static Character.UnicodeBlock MYANMAR
- ■ final static Character.UnicodeBlock NUMBER\_FORMS
- ■ static Character.UnicodeBlock off(char)
- ■ final static Character.UnicodeBlock OGHAM
- ■ final static Character.UnicodeBlock OPTICAL\_CHARACTER\_RECOGNITION
- ■ final static Character.UnicodeBlock ORIYA
- ■ final static Character.UnicodeBlock PRIVATE\_USE\_AREA
- ■ final static Character.UnicodeBlock RUNIC
- ■ final static Character.UnicodeBlock SINHALA
- ■ final static Character.UnicodeBlock SMALL\_FORM\_VARIANTS
- ■ final static Character.UnicodeBlock SPACING\_MODIFIER\_LETTERS
- ■ final static Character.UnicodeBlock SPECIALS
- ■ final static Character.UnicodeBlock SUPERSCRIPTS\_AND\_SUBSCRIPTS
- ■ final static Character.UnicodeBlock SURROGATES\_AREA
- ■ final static Character.UnicodeBlock SYRIAC
- ■ final static Character.UnicodeBlock TAMIL
- ■ final static Character.UnicodeBlock TELUGU
- ■ final static Character.UnicodeBlock THAANA
- ■ final static Character.UnicodeBlock THAI
- ■ final static Character.UnicodeBlock TIBETAN
- ■ final static Character.UnicodeBlock UNIFIED\_CANADIAN\_ABORIGINAL\_SYLLABICS
- ■ final static Character.UnicodeBlock YI\_RADICALS
- ■ final static Character.UnicodeBlock YI\_SYLLABLES
- ■ abstract CharSequence subSequence(int,int)
- ■ abstract String toString()

<ul style="list-style-type: none"> <li>■ ■ boolean desiredAssertionStatus()</li> <li>■ ■ static Class forName(String) throws ClassNotFoundException</li> <li>■ ■ static Class forName(String,boolean,ClassLoader) throws ClassNotFoundException</li> <li>■ ■ Class[] getClasses()</li> <li>■ ■ ClassLoader getClassLoader()</li> <li>■ ■ Class getComponentType()</li> <li>■ ■ Constructor getConstructor(Class[]) throws NoSuchMethodException</li> <li>■ ■ Constructor[] getConstructors()</li> <li>■ ■ Class[] getDeclaredClasses()</li> <li>■ ■ Constructor getDeclaredConstructor(Class[]) throws NoSuchMethodException</li> <li>■ ■ Constructor[] getDeclaredConstructors()</li> <li>■ ■ Field getDeclaredField(String) throws NoSuchFieldException</li> <li>■ ■ Field[] getDeclaredFields()</li> <li>■ ■ Method getDeclaredMethod(String,Class[]) throws NoSuchMethodException</li> <li>■ ■ Method[] getDeclaredMethods()</li> <li>■ ■ Class getDeclaringClass()</li> <li>■ ■ Field getField(String) throws NoSuchFieldException</li> <li>■ ■ Field[] getFields()</li> </ul>	<ul style="list-style-type: none"> <li>■ ■ Class[] getInterfaces()</li> <li>■ ■ Method getMethod(String,Class[]) throws NoSuchMethodException</li> <li>■ ■ Method[] getMethods()</li> <li>■ ■ int getModifiers()</li> <li>■ ■ String getName()</li> <li>■ ■ Package getPackage()</li> <li>■ ■ java.security.ProtectionDomain getProtectionDomain()</li> <li>■ ■ java.net.URL getResource(String)</li> <li>■ ■ java.io.InputStream getResourceAsStream(String)</li> <li>■ ■ Object[] getSigners()</li> <li>■ ■ Class getSuperclass()</li> <li>■ ■ boolean isArray()</li> <li>■ ■ boolean isAssignableFrom(Class)</li> <li>■ ■ boolean isInstance(Object)</li> <li>■ ■ boolean isInterface()</li> <li>■ ■ boolean isPrimitive()</li> <li>■ ■ Object newInstance() throws IllegalAccessException, InstantiationException</li> </ul>
<ul style="list-style-type: none"> <li>■ ■ class ClassCastException extends RuntimeException</li> <li>■ ■ ClassCastException()</li> </ul>	<ul style="list-style-type: none"> <li>■ ■ ClassCastException(String)</li> </ul>
<ul style="list-style-type: none"> <li>■ ■ class ClassCircularityError extends LinkageError</li> <li>■ ■ ClassCircularityError()</li> </ul>	<ul style="list-style-type: none"> <li>■ ■ ClassCircularityError(String)</li> </ul>
<ul style="list-style-type: none"> <li>■ ■ class ClassFormatError extends LinkageError</li> <li>■ ■ ClassFormatError()</li> </ul>	<ul style="list-style-type: none"> <li>■ ■ ClassFormatError(String)</li> </ul>
<ul style="list-style-type: none"> <li>■ ■ abstract class ClassLoader</li> <li>■ ■ protected ClassLoader()</li> <li>■ ■ protected ClassLoader(ClassLoader)</li> <li>■ ■ void clearAssertionStatus()</li> <li>■ ■ final protected Class defineClass(String,byte[],int,int) throws ClassFormatError</li> <li>■ ■ final protected Class defineClass(String,byte[],int,int, java.security.ProtectionDomain) throws ClassFormatError</li> <li>■ ■ protected Package definePackage(String,String,String,String,String,String,java.net.URL)</li> <li>■ ■ protected Class findClass(String) throws ClassNotFoundException</li> <li>■ ■ protected String findLibrary(String)</li> <li>■ ■ final protected Class findLoadedClass(String)</li> <li>■ ■ protected java.net.URL findResource(String)</li> <li>■ ■ protected java.util.Enumeration findResources(String) throws java.io.IOException</li> <li>■ ■ final protected Class findSystemClass(String) throws ClassNotFoundException</li> <li>■ ■ protected Package getPackage(String)</li> <li>■ ■ protected Package[] getPackages()</li> <li>■ ■ final ClassLoader getParent()</li> </ul>	<ul style="list-style-type: none"> <li>■ ■ java.net.URL getResource(String)</li> <li>■ ■ java.io.InputStream getResourceAsStream(String)</li> <li>■ ■ final java.util.Enumeration getResources(String) throws java.io.IOException</li> <li>■ ■ static ClassLoader getSystemClassLoader()</li> <li>■ ■ static java.net.URL getSystemResource(String)</li> <li>■ ■ static java.io.InputStream getSystemResourceAsStream(String)</li> <li>■ ■ static java.util.Enumeration getSystemResources(String) throws java.io.IOException</li> <li>■ ■ Class loadClass(String) throws ClassNotFoundException</li> <li>■ ■ protected Class loadClass(String,boolean) throws ClassNotFoundException</li> <li>■ ■ final protected void resolveClass(Class)</li> <li>■ ■ void setClassAssertionStatus(String,boolean)</li> <li>■ ■ void setDefaultAssertionStatus(boolean)</li> <li>■ ■ void setPackageAssertionStatus(String,boolean)</li> <li>■ ■ final protected void setSigners(Class,Object[])</li> </ul>
<ul style="list-style-type: none"> <li>■ ■ class ClassNotFoundException extends Exception</li> <li>■ ■ ClassNotFoundException()</li> <li>■ ■ ClassNotFoundException(String)</li> </ul>	<ul style="list-style-type: none"> <li>■ ■ ClassNotFoundException(String,Throwable)</li> <li>■ ■ Throwable getException()</li> </ul>
<ul style="list-style-type: none"> <li>■ ■ interface Cloneable</li> </ul>	
<ul style="list-style-type: none"> <li>■ ■ class CloneNotSupportedException extends Exception</li> <li>■ ■ CloneNotSupportedException()</li> </ul>	<ul style="list-style-type: none"> <li>■ ■ CloneNotSupportedException(String)</li> </ul>
<ul style="list-style-type: none"> <li>■ ■ interface Comparable</li> <li>■ ■ abstract int compareTo(Object)</li> </ul>	
<ul style="list-style-type: none"> <li>■ ■ final class Compiler</li> <li>■ ■ static Object command(Object)</li> <li>■ ■ static boolean compileClass(Class)</li> <li>■ ■ static boolean compileClasses(String)</li> </ul>	<ul style="list-style-type: none"> <li>■ ■ static void disable()</li> <li>■ ■ static void enable()</li> </ul>
<ul style="list-style-type: none"> <li>■ ■ final class Double extends Number implements Comparable</li> </ul>	



<ul style="list-style-type: none"> <li>■ ■ Double(double)</li> <li>■ ■ Double(String)</li> <li>■ ■ static int compare(double,double)</li> <li>■ ■ int compareTo(Double)</li> <li>■ ■ int compareTo(Object)</li> <li>■ ■ static long doubleToLongBits(double)</li> <li>■ ■ static long doubleToRawLongBits(double)</li> <li>■ ■ double doubleValue()</li> <li>■ ■ float floatValue()</li> <li>■ ■ int intValue()</li> <li>■ ■ boolean isInfinite()</li> <li>■ ■ static boolean isInfinite(double)</li> <li>■ ■ boolean isNaN()</li> </ul>	<ul style="list-style-type: none"> <li>■ ■ static boolean isNaN(double)</li> <li>■ ■ static double longBitsToDouble(long)</li> <li>■ ■ long longValue()</li> <li>■ ■ final static double MAX_VALUE</li> <li>■ ■ final static double MIN_VALUE</li> <li>■ ■ final static double NaN</li> <li>■ ■ final static double NEGATIVE_INFINITY</li> <li>■ ■ static double parseDouble(String)</li> <li>■ ■ final static double POSITIVE_INFINITY</li> <li>■ ■ static String toString(double)</li> <li>■ ■ final static Class TYPE</li> <li>■ ■ static Double valueOf(String)</li> </ul>
<ul style="list-style-type: none"> <li>■ ■ <b>class Error extends Throwable</b></li> <li>■ ■ Error()</li> <li>■ ■ Error(String)</li> </ul>	<ul style="list-style-type: none"> <li>■ ■ Error(String,Throwable)</li> <li>■ ■ Error(Throwable)</li> </ul>
<ul style="list-style-type: none"> <li>■ ■ <b>class Exception extends Throwable</b></li> <li>■ ■ Exception()</li> <li>■ ■ Exception(String)</li> </ul>	<ul style="list-style-type: none"> <li>■ ■ Exception(String,Throwable)</li> <li>■ ■ Exception(Throwable)</li> </ul>
<ul style="list-style-type: none"> <li>■ ■ <b>class ExceptionInitializerError extends LinkageError</b></li> <li>■ ■ ExceptionInitializerError()</li> <li>■ ■ ExceptionInitializerError(String)</li> </ul>	<ul style="list-style-type: none"> <li>■ ■ ExceptionInitializerError(Throwable)</li> <li>■ ■ Throwable getException()</li> </ul>
<ul style="list-style-type: none"> <li>■ ■ <b>final class Float extends Number implements Comparable</b></li> <li>■ ■ Float(double)</li> <li>■ ■ Float(float)</li> <li>■ ■ Float(String)</li> <li>■ ■ static int compare(float,float)</li> <li>■ ■ int compareTo(Float)</li> <li>■ ■ int compareTo(Object)</li> <li>■ ■ double doubleValue()</li> <li>■ ■ static int floatToIntBits(float)</li> <li>■ ■ static int floatToRawIntBits(float)</li> <li>■ ■ float floatValue()</li> <li>■ ■ static float intBitsToFloat(int)</li> <li>■ ■ int intValue()</li> <li>■ ■ boolean isInfinite()</li> </ul>	<ul style="list-style-type: none"> <li>■ ■ static boolean isInfinite(float)</li> <li>■ ■ boolean isNaN()</li> <li>■ ■ static boolean isNaN(float)</li> <li>■ ■ long longValue()</li> <li>■ ■ final static float MAX_VALUE</li> <li>■ ■ final static float MIN_VALUE</li> <li>■ ■ final static float NaN</li> <li>■ ■ final static float NEGATIVE_INFINITY</li> <li>■ ■ static float parseFloat(String)</li> <li>■ ■ final static float POSITIVE_INFINITY</li> <li>■ ■ static String toString(float)</li> <li>■ ■ final static Class TYPE</li> <li>■ ■ static Float valueOf(String)</li> </ul>
<ul style="list-style-type: none"> <li>■ ■ <b>class IllegalAccessError extends IncompatibleClassChangeError</b></li> <li>■ ■ IllegalAccessError()</li> </ul>	<ul style="list-style-type: none"> <li>■ ■ IllegalAccessError(String)</li> </ul>
<ul style="list-style-type: none"> <li>■ ■ <b>class IllegalAccessException extends Exception</b></li> <li>■ ■ IllegalAccessException()</li> </ul>	<ul style="list-style-type: none"> <li>■ ■ IllegalAccessException(String)</li> </ul>
<ul style="list-style-type: none"> <li>■ ■ <b>class IllegalArgumentException extends RuntimeException</b></li> <li>■ ■ IllegalArgumentException()</li> </ul>	<ul style="list-style-type: none"> <li>■ ■ IllegalArgumentException(String)</li> </ul>
<ul style="list-style-type: none"> <li>■ ■ <b>class IllegalMonitorStateException extends RuntimeException</b></li> <li>■ ■ IllegalMonitorStateException()</li> </ul>	<ul style="list-style-type: none"> <li>■ ■ IllegalMonitorStateException(String)</li> </ul>
<ul style="list-style-type: none"> <li>■ ■ <b>class IllegalStateException extends RuntimeException</b></li> <li>■ ■ IllegalStateException()</li> </ul>	<ul style="list-style-type: none"> <li>■ ■ IllegalStateException(String)</li> </ul>
<ul style="list-style-type: none"> <li>■ ■ <b>class IllegalThreadStateException extends IllegalArgumentException</b></li> <li>■ ■ IllegalThreadStateException()</li> </ul>	<ul style="list-style-type: none"> <li>■ ■ IllegalThreadStateException(String)</li> </ul>
<ul style="list-style-type: none"> <li>■ ■ <b>class IncompatibleClassChangeError extends LinkageError</b></li> <li>■ ■ IncompatibleClassChangeError()</li> </ul>	<ul style="list-style-type: none"> <li>■ ■ IncompatibleClassChangeError(String)</li> </ul>
<ul style="list-style-type: none"> <li>■ ■ <b>class IndexOutOfBoundsException extends RuntimeException</b></li> <li>■ ■ IndexOutOfBoundsException()</li> </ul>	<ul style="list-style-type: none"> <li>■ ■ IndexOutOfBoundsException(String)</li> </ul>
<ul style="list-style-type: none"> <li>■ ■ <b>class InheritableThreadLocal extends ThreadLocal</b></li> <li>■ ■ InheritableThreadLocal()</li> </ul>	<ul style="list-style-type: none"> <li>■ ■ protected Object childValue(Object)</li> </ul>
<ul style="list-style-type: none"> <li>■ ■ <b>class InstantiationException extends IncompatibleClassChangeError</b></li> <li>■ ■ InstantiationException()</li> </ul>	<ul style="list-style-type: none"> <li>■ ■ InstantiationException(String)</li> </ul>
<ul style="list-style-type: none"> <li>■ ■ <b>class InstantiationException extends Exception</b></li> <li>■ ■ InstantiationException()</li> </ul>	<ul style="list-style-type: none"> <li>■ ■ InstantiationException(String)</li> </ul>
<ul style="list-style-type: none"> <li>■ ■ <b>final class Integer extends Number implements Comparable</b></li> </ul>	

<ul style="list-style-type: none"> <li>■ ■ Integer(int)</li> <li>■ ■ Integer(String)</li> <li>■ ■ int compareTo(Integer)</li> <li>■ ■ int compareTo(Object)</li> <li>■ ■ static Integer decode(String)</li> <li>■ ■ double doubleValue()</li> <li>■ ■ float floatValue()</li> <li>■ ■ static Integer getInteger(String)</li> <li>■ ■ static Integer getInteger(String,int)</li> <li>■ ■ static Integer getInteger(String,Integer)</li> <li>■ ■ int intValue()</li> <li>■ ■ long longValue()</li> </ul>	<ul style="list-style-type: none"> <li>■ ■ final static int MAX_VALUE</li> <li>■ ■ final static int MIN_VALUE</li> <li>■ ■ static int parseInt(String)</li> <li>■ ■ static int parseInt(String,int)</li> <li>■ ■ static String toBinaryString(int)</li> <li>■ ■ static String toHexString(int)</li> <li>■ ■ static String toOctalString(int)</li> <li>■ ■ static String toString(int)</li> <li>■ ■ static String toString(int,int)</li> <li>■ ■ final static Class TYPE</li> <li>■ ■ static Integer valueOf(String)</li> <li>■ ■ static Integer valueOf(String,int)</li> </ul>
<ul style="list-style-type: none"> <li>■ ■ class InternalError extends VirtualMachineError</li> <li>■ ■ InternalError()</li> </ul>	<ul style="list-style-type: none"> <li>■ ■ InternalError(String)</li> </ul>
<ul style="list-style-type: none"> <li>■ ■ class InterruptedException extends Exception</li> <li>■ ■ InterruptedException()</li> </ul>	<ul style="list-style-type: none"> <li>■ ■ InterruptedException(String)</li> </ul>
<ul style="list-style-type: none"> <li>■ ■ class LinkageError extends Error</li> <li>■ ■ LinkageError()</li> </ul>	<ul style="list-style-type: none"> <li>■ ■ LinkageError(String)</li> </ul>
<ul style="list-style-type: none"> <li>■ ■ final class Long extends Number implements Comparable</li> <li>■ ■ Long(long)</li> <li>■ ■ Long(String)</li> <li>■ ■ int compareTo(Long)</li> <li>■ ■ int compareTo(Object)</li> <li>■ ■ static Long decode(String)</li> <li>■ ■ double doubleValue()</li> <li>■ ■ float floatValue()</li> <li>■ ■ static Long getLong(String)</li> <li>■ ■ static Long getLong(String,long)</li> <li>■ ■ static Long getLong(String,Long)</li> <li>■ ■ int intValue()</li> <li>■ ■ long longValue()</li> </ul>	<ul style="list-style-type: none"> <li>■ ■ final static long MAX_VALUE</li> <li>■ ■ final static long MIN_VALUE</li> <li>■ ■ static long parseLong(String)</li> <li>■ ■ static long parseLong(String,int)</li> <li>■ ■ static String toBinaryString(long)</li> <li>■ ■ static String toHexString(long)</li> <li>■ ■ static String toOctalString(long)</li> <li>■ ■ static String toString(long)</li> <li>■ ■ static String toString(long,int)</li> <li>■ ■ final static Class TYPE</li> <li>■ ■ static Long valueOf(String)</li> <li>■ ■ static Long valueOf(String,int)</li> </ul>
<ul style="list-style-type: none"> <li>■ ■ final class Math</li> <li>■ ■ static double abs(double)</li> <li>■ ■ static float abs(float)</li> <li>■ ■ static int abs(int)</li> <li>■ ■ static long abs(long)</li> <li>■ ■ static double acos(double)</li> <li>■ ■ static double asin(double)</li> <li>■ ■ static double atan(double)</li> <li>■ ■ static double atan2(double,double)</li> <li>■ ■ static double ceil(double)</li> <li>■ ■ static double cos(double)</li> <li>■ ■ final static double E</li> <li>■ ■ static double exp(double)</li> <li>■ ■ static double floor(double)</li> <li>■ ■ static double IEEEremainder(double,double)</li> <li>■ ■ static double log(double)</li> <li>■ ■ static double max(double,double)</li> <li>■ ■ static float max(float,float)</li> </ul>	<ul style="list-style-type: none"> <li>■ ■ static int max(int,int)</li> <li>■ ■ static long max(long,long)</li> <li>■ ■ static double min(double,double)</li> <li>■ ■ static float min(float,float)</li> <li>■ ■ static int min(int,int)</li> <li>■ ■ static long min(long,long)</li> <li>■ ■ final static double PI</li> <li>■ ■ static double pow(double,double)</li> <li>■ ■ static double random()</li> <li>■ ■ static double rint(double)</li> <li>■ ■ static long round(double)</li> <li>■ ■ static int round(float)</li> <li>■ ■ static double sin(double)</li> <li>■ ■ static double sqrt(double)</li> <li>■ ■ static double tan(double)</li> <li>■ ■ static double toDegrees(double)</li> <li>■ ■ static double toRadians(double)</li> </ul>
<ul style="list-style-type: none"> <li>■ ■ class NegativeArraySizeException extends RuntimeException</li> <li>■ ■ NegativeArraySizeException()</li> </ul>	<ul style="list-style-type: none"> <li>■ ■ NegativeArraySizeException(String)</li> </ul>
<ul style="list-style-type: none"> <li>■ ■ class NoClassDefFoundError extends LinkageError</li> <li>■ ■ NoClassDefFoundError()</li> </ul>	<ul style="list-style-type: none"> <li>■ ■ NoClassDefFoundError(String)</li> </ul>
<ul style="list-style-type: none"> <li>■ ■ class NoSuchFieldError extends IncompatibleClassChangeError</li> <li>■ ■ NoSuchFieldError()</li> </ul>	<ul style="list-style-type: none"> <li>■ ■ NoSuchFieldError(String)</li> </ul>
<ul style="list-style-type: none"> <li>■ ■ class NoSuchFieldException extends Exception</li> <li>■ ■ NoSuchFieldException()</li> </ul>	<ul style="list-style-type: none"> <li>■ ■ NoSuchFieldException(String)</li> </ul>
<ul style="list-style-type: none"> <li>■ ■ class NoSuchMethodError extends IncompatibleClassChangeError</li> <li>■ ■ NoSuchMethodError()</li> </ul>	<ul style="list-style-type: none"> <li>■ ■ NoSuchMethodError(String)</li> </ul>
<ul style="list-style-type: none"> <li>■ ■ class NoSuchMethodException extends Exception</li> <li>■ ■ NoSuchMethodException()</li> </ul>	<ul style="list-style-type: none"> <li>■ ■ NoSuchMethodException(String)</li> </ul>
<ul style="list-style-type: none"> <li>■ ■ class NullPointerException extends RuntimeException</li> <li>■ ■ NullPointerException()</li> </ul>	<ul style="list-style-type: none"> <li>■ ■ NullPointerException(String)</li> </ul>
<ul style="list-style-type: none"> <li>■ ■ abstract class Number implements java.io.Serializable</li> <li>■ ■ Number()</li> <li>■ ■ byte byteValue()</li> <li>■ ■ abstract double doubleValue()</li> <li>■ ■ abstract float floatValue()</li> </ul>	<ul style="list-style-type: none"> <li>■ ■ abstract int intValue()</li> <li>■ ■ abstract long longValue()</li> <li>■ ■ short shortValue()</li> </ul>
<ul style="list-style-type: none"> <li>■ ■ class NumberFormatException extends IllegalArgumentException</li> <li>■ ■ NumberFormatException()</li> </ul>	<ul style="list-style-type: none"> <li>■ ■ NumberFormatException(String)</li> </ul>
<ul style="list-style-type: none"> <li>■ ■ class Object</li> </ul>	

<ul style="list-style-type: none"> <li>■ ■ Object()</li> <li>■ ■ protected Object clone() throws CloneNotSupportedException</li> <li>■ ■ boolean equals(Object)</li> <li>■ ■ protected void finalize() throws Throwable</li> <li>■ ■ final Class getClass()</li> <li>■ ■ int hashCode()</li> </ul>	<ul style="list-style-type: none"> <li>■ ■ final void notify()</li> <li>■ ■ final void notifyAll()</li> <li>■ ■ String toString()</li> <li>■ ■ final void wait() throws InterruptedException</li> <li>■ ■ final void wait(long) throws InterruptedException</li> <li>■ ■ final void wait(long,int) throws InterruptedException</li> </ul>
<ul style="list-style-type: none"> <li>■ ■ <b>class OutOfMemoryError extends VirtualMachineError</b></li> <li>■ ■ OutOfMemoryError()</li> </ul>	<ul style="list-style-type: none"> <li>■ ■ OutOfMemoryError(String)</li> </ul>
<ul style="list-style-type: none"> <li>■ ■ <b>class Package</b></li> <li>■ ■ String getImplementationTitle()</li> <li>■ ■ String getImplementationVendor()</li> <li>■ ■ String getImplementationVersion()</li> <li>■ ■ String getName()</li> <li>■ ■ static Package getPackage(String)</li> <li>■ ■ static Package[] getPackages()</li> </ul>	<ul style="list-style-type: none"> <li>■ ■ String getSpecificationTitle()</li> <li>■ ■ String getSpecificationVendor()</li> <li>■ ■ String getSpecificationVersion()</li> <li>■ ■ boolean isCompatibleWith(String)</li> <li>■ ■ boolean isSealed()</li> <li>■ ■ boolean isSealed(java.net.URL)</li> </ul>
<ul style="list-style-type: none"> <li>■ ■ <b>abstract class Process</b></li> <li>■ ■ Process()</li> <li>■ ■ abstract void destroy()</li> <li>■ ■ abstract int exitValue()</li> <li>■ ■ abstract java.io.InputStream getErrorStream()</li> </ul>	<ul style="list-style-type: none"> <li>■ ■ abstract java.io.InputStream getInputStream()</li> <li>■ ■ abstract java.io.OutputStream getOutputStream()</li> <li>■ ■ abstract int waitFor() throws InterruptedException</li> </ul>
<ul style="list-style-type: none"> <li>■ ■ <b>interface Runnable</b></li> <li>■ ■ abstract void run()</li> </ul>	
<ul style="list-style-type: none"> <li>■ ■ <b>class Runtime</b></li> <li>■ ■ void addShutdownHook(Thread)</li> <li>■ ■ int availableProcessors()</li> <li>■ ■ Process exec(String[]) throws java.io.IOException</li> <li>■ ■ Process exec(String[],String[]) throws java.io.IOException</li> <li>■ ■ Process exec(String[],String[],java.io.File) throws java.io.IOException</li> <li>■ ■ Process exec(String) throws java.io.IOException</li> <li>■ ■ Process exec(String,String[]) throws java.io.IOException</li> <li>■ ■ Process exec(String,String[],java.io.File) throws java.io.IOException</li> <li>■ ■ void exit(int)</li> <li>■ ■ long freeMemory()</li> <li>■ ■ void gc()</li> </ul>	<ul style="list-style-type: none"> <li>■ ■ static Runtime getRuntime()</li> <li>■ ■ void halt(int)</li> <li>■ ■ void load(String)</li> <li>■ ■ void loadLibrary(String)</li> <li>■ ■ long maxMemory()</li> <li>■ ■ boolean removeShutdownHook(Thread)</li> <li>■ ■ void runFinalization()</li> <li>■ ■ long totalMemory()</li> <li>■ ■ void traceInstructions(boolean)</li> <li>■ ■ void traceMethodCalls(boolean)</li> </ul>
<ul style="list-style-type: none"> <li>■ ■ <b>class RuntimeException extends Exception</b></li> <li>■ ■ RuntimeException()</li> <li>■ ■ RuntimeException(String)</li> </ul>	<ul style="list-style-type: none"> <li>■ ■ RuntimeException(String,Throwable)</li> <li>■ ■ RuntimeException(Throwable)</li> </ul>
<ul style="list-style-type: none"> <li>■ ■ <b>final class RuntimePermission extends java.security.BasicPermission</b></li> <li>■ ■ RuntimePermission(String)</li> </ul>	<ul style="list-style-type: none"> <li>■ ■ RuntimePermission(String,String)</li> </ul>
<ul style="list-style-type: none"> <li>■ ■ <b>class SecurityException extends RuntimeException</b></li> <li>■ ■ SecurityException()</li> </ul>	<ul style="list-style-type: none"> <li>■ ■ SecurityException(String)</li> </ul>
<ul style="list-style-type: none"> <li>■ ■ <b>class SecurityManager</b></li> <li>■ ■ SecurityManager()</li> <li>■ ■ void checkAccept(String,int)</li> <li>■ ■ void checkAccess(Thread)</li> <li>■ ■ void checkAccess(ThreadGroup)</li> <li>■ ■ void checkAwtEventQueueAccess()</li> <li>■ ■ void checkConnect(String,int)</li> <li>■ ■ void checkConnect(String,int,Object)</li> <li>■ ■ void checkCreateClassLoader()</li> <li>■ ■ void checkDelete(String)</li> <li>■ ■ void checkExec(String)</li> <li>■ ■ void checkExit(int)</li> <li>■ ■ void checkLink(String)</li> <li>■ ■ void checkListen(int)</li> <li>■ ■ void checkMemberAccess(Class,int)</li> <li>■ ■ void checkMulticast(java.net.InetAddress)</li> <li>■ ■ void checkMulticast(java.net.InetAddress,byte)</li> <li>■ ■ void checkPackageAccess(String)</li> <li>■ ■ void checkPackageDefinition(String)</li> </ul>	<ul style="list-style-type: none"> <li>■ ■ void checkPermission(java.security.Permission)</li> <li>■ ■ void checkPermission(java.security.Permission,Object)</li> <li>■ ■ void checkPrintJobAccess()</li> <li>■ ■ void checkPropertiesAccess()</li> <li>■ ■ void checkPropertyAccess(String)</li> <li>■ ■ void checkRead(java.io.FileDescriptor)</li> <li>■ ■ void checkRead(String)</li> <li>■ ■ void checkRead(String,Object)</li> <li>■ ■ void checkSecurityAccess(String)</li> <li>■ ■ void checkSetFactory()</li> <li>■ ■ void checkSystemClipboardAccess()</li> <li>■ ■ boolean checkTopLevelWindow(Object)</li> <li>■ ■ void checkWrite(java.io.FileDescriptor)</li> <li>■ ■ void checkWrite(String)</li> <li>■ ■ protected Class[] getClassContext()</li> <li>■ ■ Object getSecurityContext()</li> <li>■ ■ ThreadGroup getThreadGroup()</li> </ul>
<ul style="list-style-type: none"> <li>■ ■ <b>final class Short extends Number implements Comparable</b></li> <li>■ ■ Short(String)</li> <li>■ ■ Short(short)</li> <li>■ ■ int compareTo(Object)</li> <li>■ ■ int compareTo(Short)</li> <li>■ ■ static Short decode(String)</li> <li>■ ■ double doubleValue()</li> <li>■ ■ float floatValue()</li> <li>■ ■ int intValue()</li> <li>■ ■ long longValue()</li> </ul>	<ul style="list-style-type: none"> <li>■ ■ final static short MAX_VALUE</li> <li>■ ■ final static short MIN_VALUE</li> <li>■ ■ static short parseShort(String)</li> <li>■ ■ static short parseShort(String,int)</li> <li>■ ■ static String toString(short)</li> <li>■ ■ final static Class TYPE</li> <li>■ ■ static Short valueOf(String)</li> <li>■ ■ static Short valueOf(String,int)</li> </ul>
<ul style="list-style-type: none"> <li>■ ■ <b>class StackOverflowError extends VirtualMachineError</b></li> <li>■ ■ StackOverflowError()</li> </ul>	<ul style="list-style-type: none"> <li>■ ■ StackOverflowError(String)</li> </ul>

---

<b>final class StackTraceElement implements java.io.Serializable</b>	
<ul style="list-style-type: none"> <li>■ ■ String getClassName()</li> <li>■ ■ String getFileName()</li> <li>■ ■ int getLineNumber()</li> </ul>	<ul style="list-style-type: none"> <li>■ ■ String getMethodName()</li> <li>■ ■ boolean isNativeMethod()</li> </ul>
<hr/>	
<b>final class StrictMath</b>	
<ul style="list-style-type: none"> <li>■ ■ static double abs(double)</li> <li>■ ■ static float abs(float)</li> <li>■ ■ static int abs(int)</li> <li>■ ■ static long abs(long)</li> <li>■ ■ static double acos(double)</li> <li>■ ■ static double asin(double)</li> <li>■ ■ static double atan(double)</li> <li>■ ■ static double atan2(double,double)</li> <li>■ ■ static double ceil(double)</li> <li>■ ■ static double cos(double)</li> <li>■ ■ final static double E</li> <li>■ ■ static double exp(double)</li> <li>■ ■ static double floor(double)</li> <li>■ ■ static double IEEEremainder(double,double)</li> <li>■ ■ static double log(double)</li> <li>■ ■ static double max(double,double)</li> <li>■ ■ static float max(float,float)</li> </ul>	<ul style="list-style-type: none"> <li>■ ■ static int max(int,int)</li> <li>■ ■ static long max(long,long)</li> <li>■ ■ static double min(double,double)</li> <li>■ ■ static float min(float,float)</li> <li>■ ■ static int min(int,int)</li> <li>■ ■ static long min(long,long)</li> <li>■ ■ final static double PI</li> <li>■ ■ static double pow(double,double)</li> <li>■ ■ static double random()</li> <li>■ ■ static double rint(double)</li> <li>■ ■ static long round(double)</li> <li>■ ■ static int round(float)</li> <li>■ ■ static double sin(double)</li> <li>■ ■ static double sqrt(double)</li> <li>■ ■ static double tan(double)</li> <li>■ ■ static double toDegrees(double)</li> <li>■ ■ static double toRadians(double)</li> </ul>
<hr/>	
<b>final class String implements java.io.Serializable , CharSequence , Comparable</b>	
<ul style="list-style-type: none"> <li>■ ■ String()</li> <li>■ ■ String(byte[])</li> <li>■ ■ String(byte[],int,int)</li> <li>■ ■ String(byte[],int,int,String)</li> </ul>	<ul style="list-style-type: none"> <li>■ ■ int lastIndexOf(int)</li> <li>■ ■ int lastIndexOf(int,int)</li> <li>■ ■ int lastIndexOf(String)</li> <li>■ ■ int lastIndexOf(String,int)</li> <li>■ ■ int length()</li> </ul>
<ul style="list-style-type: none"> <li>throws java.io.UnsupportedEncodingException</li> <li>■ ■ String(byte[],String) throws java.io.UnsupportedEncodingException</li> <li>■ ■ String(char[])</li> <li>■ ■ String(char[],int,int)</li> <li>■ ■ String(String)</li> <li>■ ■ String(StringBuffer)</li> <li>■ ■ final static java.util.Comparator CASE_INSENSITIVE_ORDER</li> <li>■ ■ char charAt(int)</li> <li>■ ■ int compareTo(Object)</li> <li>■ ■ int compareTo(String)</li> <li>■ ■ int compareToIgnoreCase(String)</li> <li>■ ■ String concat(String)</li> <li>■ ■ boolean contentEquals(StringBuffer)</li> <li>■ ■ static String copyValueOf(char[])</li> <li>■ ■ static String copyValueOf(char[],int,int)</li> <li>■ ■ boolean endsWith(String)</li> <li>■ ■ boolean equalsIgnoreCase(String)</li> <li>■ ■ byte[] getBytes()</li> <li>■ ■ byte[] getBytes(String) throws java.io.UnsupportedEncodingException</li> <li>■ ■ void getChars(int,int,char[],int)</li> <li>■ ■ int indexOf(int)</li> <li>■ ■ int indexOf(int,int)</li> <li>■ ■ int indexOf(String)</li> <li>■ ■ int indexOf(String,int)</li> <li>■ ■ String intern()</li> </ul>	<ul style="list-style-type: none"> <li>■ ■ boolean regionMatches(int,String,int,int)</li> <li>■ ■ boolean regionMatches(boolean,int,String,int,int)</li> <li>■ ■ String replace(char,char)</li> <li>■ ■ boolean startsWith(String)</li> <li>■ ■ boolean startsWith(String,int)</li> <li>■ ■ CharSequence subSequence(int,int)</li> <li>■ ■ String substring(int)</li> <li>■ ■ String substring(int,int)</li> <li>■ ■ char[] toCharArray()</li> <li>■ ■ String toLowerCase()</li> <li>■ ■ String toLowerCase(java.util.Locale)</li> <li>■ ■ String toUpperCase()</li> <li>■ ■ String toUpperCase(java.util.Locale)</li> <li>■ ■ String trim()</li> <li>■ ■ static String valueOf(char[])</li> <li>■ ■ static String valueOf(char[],int,int)</li> <li>■ ■ static String valueOf(char)</li> <li>■ ■ static String valueOf(double)</li> <li>■ ■ static String valueOf(float)</li> <li>■ ■ static String valueOf(int)</li> <li>■ ■ static String valueOf(long)</li> <li>■ ■ static String valueOf(Object)</li> <li>■ ■ static String valueOf(boolean)</li> </ul>
<hr/>	
<b>final class StringBuffer implements java.io.Serializable , CharSequence</b>	
<ul style="list-style-type: none"> <li>■ ■ StringBuffer()</li> <li>■ ■ StringBuffer(int)</li> <li>■ ■ StringBuffer(String)</li> <li>■ ■ StringBuffer append(char[])</li> <li>■ ■ StringBuffer append(char[],int,int)</li> <li>■ ■ StringBuffer append(char)</li> <li>■ ■ StringBuffer append(double)</li> <li>■ ■ StringBuffer append(float)</li> <li>■ ■ StringBuffer append(int)</li> <li>■ ■ StringBuffer append(long)</li> <li>■ ■ StringBuffer append(Object)</li> <li>■ ■ StringBuffer append(String)</li> <li>■ ■ StringBuffer append(StringBuffer)</li> <li>■ ■ StringBuffer append(boolean)</li> <li>■ ■ int capacity()</li> <li>■ ■ char charAt(int)</li> <li>■ ■ StringBuffer delete(int,int)</li> <li>■ ■ StringBuffer deleteCharAt(int)</li> <li>■ ■ void ensureCapacity(int)</li> <li>■ ■ void getChars(int,int,char[],int)</li> <li>■ ■ int indexOf(String)</li> </ul>	<ul style="list-style-type: none"> <li>■ ■ int indexOf(String,int)</li> <li>■ ■ StringBuffer insert(int,char[])</li> <li>■ ■ StringBuffer insert(int,char[],int,int)</li> <li>■ ■ StringBuffer insert(int,char)</li> <li>■ ■ StringBuffer insert(int,double)</li> <li>■ ■ StringBuffer insert(int,float)</li> <li>■ ■ StringBuffer insert(int,int)</li> <li>■ ■ StringBuffer insert(int,long)</li> <li>■ ■ StringBuffer insert(int,Object)</li> <li>■ ■ StringBuffer insert(int,String)</li> <li>■ ■ StringBuffer insert(int,boolean)</li> <li>■ ■ int lastIndexOf(String)</li> <li>■ ■ int lastIndexOf(String,int)</li> <li>■ ■ int length()</li> <li>■ ■ StringBuffer replace(int,int,String)</li> <li>■ ■ StringBuffer reverse()</li> <li>■ ■ void setCharAt(int,char)</li> <li>■ ■ void setLength(int)</li> <li>■ ■ CharSequence subSequence(int,int)</li> <li>■ ■ String substring(int)</li> <li>■ ■ String substring(int,int)</li> </ul>

---

---

<b>■ ■ class StringIndexOutOfBoundsException extends IndexOutOfBoundsException</b>	
■ ■ StringIndexOutOfBoundsException()	■ ■ StringIndexOutOfBoundsException(String)
■ ■ StringIndexOutOfBoundsException(int)	
<b>■ ■ final class System</b>	
■ ■ static void arraycopy(Object,int,Object,int,int)	■ ■ static void load(String)
■ ■ static long currentTimeMillis()	■ ■ static void loadLibrary(String)
■ ■ final static java.io.PrintStream err	■ ■ static String mapLibraryName(String)
■ ■ static void exit(int)	■ ■ final static java.io.PrintStream out
■ ■ static void gc()	■ ■ static void runFinalization()
■ ■ static java.util.Properties getProperties()	■ ■ static void setErr(java.io.PrintStream)
■ ■ static String getProperty(String)	■ ■ static void setIn(java.io.InputStream)
■ ■ static String getProperty(String,String)	■ ■ static void setOut(java.io.PrintStream)
■ ■ static SecurityManager getSecurityManager()	■ ■ static void setProperties(java.util.Properties)
■ ■ static int identityHashCode(Object)	■ ■ static String setProperty(String,String)
■ ■ final static java.io.InputStream in	■ ■ static void setSecurityManager(SecurityManager)
<b>■ ■ class Thread implements Runnable</b>	
■ ■ Thread()	■ ■ static boolean interrupted()
■ ■ Thread(Runnable)	■ ■ final boolean isAlive()
■ ■ Thread(Runnable,String)	■ ■ final boolean isDaemon()
■ ■ Thread(String)	■ ■ boolean isInterrupted()
■ ■ Thread(ThreadGroup,Runnable)	■ ■ final void join() throws InterruptedException
■ ■ Thread(ThreadGroup,Runnable,String)	■ ■ final void join(long) throws InterruptedException
■ ■ Thread(ThreadGroup,Runnable,String,long)	■ ■ final void join(long,int) throws InterruptedException
■ ■ Thread(ThreadGroup,String)	■ ■ final static int MAX_PRIORITY
■ ■ static int activeCount()	■ ■ final static int MIN_PRIORITY
■ ■ final void checkAccess()	■ ■ final static int NORM_PRIORITY
■ ■ static Thread currentThread()	■ ■ void run()
■ ■ void destroy()	■ ■ void setContextClassLoader(ClassLoader)
■ ■ static void dumpStack()	■ ■ final void setDaemon(boolean)
■ ■ static int enumerate(Thread[])	■ ■ final void setName(String)
■ ■ ClassLoader getContextClassLoader()	■ ■ final void setPriority(int)
■ ■ final String getName()	■ ■ static void sleep(long) throws InterruptedException
■ ■ final int getPriority()	■ ■ static void sleep(long,int) throws InterruptedException
■ ■ final ThreadGroup getThreadGroup()	■ ■ void start()
■ ■ static boolean holdsLock(Object)	■ ■ static void yield()
■ ■ void interrupt()	
<b>■ ■ class ThreadDeath extends Error</b>	
■ ■ ThreadDeath()	
<b>■ ■ class ThreadGroup</b>	
■ ■ ThreadGroup(String)	■ ■ final String getName()
■ ■ ThreadGroup(ThreadGroup,String)	■ ■ final ThreadGroup getParent()
■ ■ int activeCount()	■ ■ final void interrupt()
■ ■ int activeGroupCount()	■ ■ final boolean isDaemon()
■ ■ final void checkAccess()	■ ■ boolean isDestroyed()
■ ■ final void destroy()	■ ■ void list()
■ ■ int enumerate(Thread[])	■ ■ final boolean parentOf(ThreadGroup)
■ ■ int enumerate(Thread[],boolean)	■ ■ final void setDaemon(boolean)
■ ■ int enumerate(ThreadGroup[])	■ ■ final void setMaxPriority(int)
■ ■ int enumerate(ThreadGroup[],boolean)	■ ■ void uncaughtException(Thread,Throwable)
■ ■ final int getMaxPriority()	
<b>■ ■ class ThreadLocal</b>	
■ ■ ThreadLocal()	■ ■ protected Object initialValue()
■ ■ Object get()	■ ■ void set(Object)
<b>■ ■ class Throwable implements java.io.Serializable</b>	
■ ■ Throwable()	■ ■ String getMessage()
■ ■ Throwable(String)	■ ■ StackTraceElement[] getStackTrace()
■ ■ Throwable(String,Throwable)	■ ■ Throwable initCause(Throwable)
■ ■ Throwable(Throwable)	■ ■ void printStackTrace()
■ ■ Throwable fillInStackTrace()	■ ■ void printStackTrace(java.io.PrintStream)
■ ■ Throwable getCause()	■ ■ void printStackTrace(java.io.PrintWriter)
■ ■ String getLocalizedMessage()	■ ■ void setStackTrace(StackTraceElement[])
<b>■ ■ class UnknownError extends VirtualMachineError</b>	
■ ■ UnknownError()	■ ■ UnknownError(String)
<b>■ ■ class UnsatisfiedLinkError extends LinkageError</b>	
■ ■ UnsatisfiedLinkError()	■ ■ UnsatisfiedLinkError(String)
<b>■ ■ class UnsupportedClassVersionError extends ClassFormatError</b>	
■ ■ UnsupportedClassVersionError()	■ ■ UnsupportedClassVersionError(String)
<b>■ ■ class UnsupportedOperationException extends RuntimeException</b>	
■ ■ UnsupportedOperationException()	■ ■ UnsupportedOperationException(String)
<b>■ ■ class VerifyError extends LinkageError</b>	
■ ■ VerifyError()	■ ■ VerifyError(String)

---

---

■ ■ <b>abstract class VirtualMachineError extends Error</b>	
■ ■ VirtualMachineError()	■ ■ VirtualMachineError(String)
■ ■ <b>final class Void</b>	
■ ■ final static Class TYPE	

---

## 999.3.3

**java.lang.ref**

---

■ ■ <b>package java.lang.ref</b>	
■ ■ <b>class PhantomReference extends Reference</b>	
■ ■ PhantomReference(Object,ReferenceQueue)	
■ ■ <b>abstract class Reference</b>	
■ ■ void clear()	■ ■ Object get()
■ ■ boolean enqueue()	■ ■ boolean isEnqueued()
■ ■ <b>class ReferenceQueue</b>	
■ ■ ReferenceQueue()	■ ■ Reference remove() throws InterruptedException
■ ■ Reference poll()	■ ■ Reference remove(long) throws InterruptedException
■ ■ <b>class SoftReference extends Reference</b>	
■ ■ SoftReference(Object)	■ ■ SoftReference(Object,ReferenceQueue)
■ ■ <b>class WeakReference extends Reference</b>	
■ ■ WeakReference(Object)	■ ■ WeakReference(Object,ReferenceQueue)

---

## 999.3.4

**java.lang.reflect**

---

■ ■ <b>package java.lang.reflect</b>	
■ ■ <b>class AccessibleObject</b>	
■ ■ protected AccessibleObject()	■ ■ static void setAccessible(AccessibleObject[],boolean)
■ ■ boolean isAccessible()	■ ■ void setAccessible(boolean)
■ ■ <b>final class Array</b>	
■ ■ static Object get(Object,int)	■ ■ static Object newInstance(Class,int)
■ ■ static boolean getBoolean(Object,int)	■ ■ static void set(Object,int,Object)
■ ■ static byte getByte(Object,int)	■ ■ static void setBoolean(Object,int,boolean)
■ ■ static char getChar(Object,int)	■ ■ static void setByte(Object,int,byte)
■ ■ static double getDouble(Object,int)	■ ■ static void setChar(Object,int,char)
■ ■ static float getFloat(Object,int)	■ ■ static void setDouble(Object,int,double)
■ ■ static int getInt(Object,int)	■ ■ static void setFloat(Object,int,float)
■ ■ static int getLength(Object)	■ ■ static void setInt(Object,int,int)
■ ■ static long getLong(Object,int)	■ ■ static void setLong(Object,int,long)
■ ■ static short getShort(Object,int)	■ ■ static void setShort(Object,int,short)
■ ■ static Object newInstance(Class,int[])	
■ ■ <b>final class Constructor extends AccessibleObject implements Member</b>	
■ ■ Class getDeclaringClass()	■ ■ String getName()
■ ■ Class[] getExceptionTypes()	■ ■ Class[] getParameterTypes()
■ ■ int getModifiers()	■ ■ Object newInstance(Object[]) throws IllegalAccessException, InstantiationException, InvocationTargetException
■ ■ <b>final class Field extends AccessibleObject implements Member</b>	
■ ■ Object get(Object) throws IllegalAccessException	■ ■ short getShort(Object) throws IllegalAccessException
■ ■ boolean getBoolean(Object) throws IllegalAccessException	■ ■ Class getType()
■ ■ byte getByte(Object) throws IllegalAccessException	■ ■ void set(Object,Object) throws IllegalAccessException
■ ■ char getChar(Object) throws IllegalAccessException	■ ■ void setBoolean(Object,boolean) throws IllegalAccessException
■ ■ Class getDeclaringClass()	■ ■ void setByte(Object,byte) throws IllegalAccessException
■ ■ double getDouble(Object) throws IllegalAccessException	■ ■ void setChar(Object,char) throws IllegalAccessException
■ ■ float getFloat(Object) throws IllegalAccessException	■ ■ void setDouble(Object,double) throws IllegalAccessException
■ ■ int getInt(Object) throws IllegalAccessException	■ ■ void setFloat(Object,float) throws IllegalAccessException
■ ■ long getLong(Object) throws IllegalAccessException	■ ■ void setInt(Object,int) throws IllegalAccessException
■ ■ int getModifiers()	■ ■ void setLong(Object,long) throws IllegalAccessException
■ ■ String getName()	■ ■ void setShort(Object,short) throws IllegalAccessException
■ ■ <b>interface InvocationHandler</b>	
■ ■ abstract Object invoke(Object,Method,Object[]) throws Throwable	
■ ■ <b>class InvocationTargetException extends Exception</b>	
■ ■ protected InvocationTargetException()	■ ■ InvocationTargetException(Throwable,String)
■ ■ InvocationTargetException(Throwable)	■ ■ Throwable getTargetException()
■ ■ <b>interface Member</b>	
■ ■ final static int DECLARED	■ ■ abstract String getName()
■ ■ abstract Class getDeclaringClass()	■ ■ final static int PUBLIC
■ ■ abstract int getModifiers()	
■ ■ <b>final class Method extends AccessibleObject implements Member</b>	
■ ■ Class getDeclaringClass()	■ ■ Class[] getParameterTypes()
■ ■ Class[] getExceptionTypes()	■ ■ Class getReturnType()
■ ■ int getModifiers()	■ ■ Object invoke(Object,Object[]) throws IllegalAccessException, InvocationTargetException
■ ■ String getName()	

---

---

<ul style="list-style-type: none"> <li>■ ■ <b>class Modifier</b></li> <li>■ ■ Modifier()</li> <li>■ ■ final static int ABSTRACT</li> <li>■ ■ final static int FINAL</li> <li>■ ■ final static int INTERFACE</li> <li>■ ■ static boolean isAbstract(int)</li> <li>■ ■ static boolean isFinal(int)</li> <li>■ ■ static boolean isInterface(int)</li> <li>■ ■ static boolean isNative(int)</li> <li>■ ■ static boolean isPrivate(int)</li> <li>■ ■ static boolean isProtected(int)</li> <li>■ ■ static boolean isPublic(int)</li> <li>■ ■ static boolean isStatic(int)</li> <li>■ ■ static boolean isStrict(int)</li> </ul>	<ul style="list-style-type: none"> <li>■ ■ static boolean isSynchronized(int)</li> <li>■ ■ static boolean isTransient(int)</li> <li>■ ■ static boolean isVolatile(int)</li> <li>■ ■ final static int NATIVE</li> <li>■ ■ final static int PRIVATE</li> <li>■ ■ final static int PROTECTED</li> <li>■ ■ final static int PUBLIC</li> <li>■ ■ final static int STATIC</li> <li>■ ■ final static int STRICT</li> <li>■ ■ final static int SYNCHRONIZED</li> <li>■ ■ static String toString(int)</li> <li>■ ■ final static int TRANSIENT</li> <li>■ ■ final static int VOLATILE</li> </ul>
<ul style="list-style-type: none"> <li>■ ■ <b>class Proxy implements java.io.Serializable</b></li> <li>■ ■ protected Proxy(InvocationHandler)</li> <li>■ ■ static InvocationHandler getInvocationHandler(Object)</li> <li>■ ■ static Class getProxyClass(ClassLoader,Class[])</li> </ul>	<ul style="list-style-type: none"> <li>■ ■ protected InvocationHandler h</li> <li>■ ■ static boolean isProxyClass(Class)</li> <li>■ ■ static Object newProxyInstance(ClassLoader,Class[],InvocationHandler)</li> </ul>
<ul style="list-style-type: none"> <li>■ ■ <b>final class ReflectPermission extends java.security.BasicPermission</b></li> <li>■ ■ ReflectPermission(String)</li> </ul>	<ul style="list-style-type: none"> <li>■ ■ ReflectPermission(String,String)</li> </ul>
<ul style="list-style-type: none"> <li>■ ■ <b>class UndeclaredThrowableException extends RuntimeException</b></li> <li>■ ■ UndeclaredThrowableException(Throwable)</li> <li>■ ■ UndeclaredThrowableException(Throwable,String)</li> </ul>	<ul style="list-style-type: none"> <li>■ ■ Throwable getUndeclaredThrowable()</li> </ul>

---

## 999-3.5

**java.math**

---

<ul style="list-style-type: none"> <li>■ ■ <b>package java.math</b></li> <li>■ ■ <b>class BigDecimal extends Number implements Comparable</b></li> <li>■ ■ BigDecimal(double)</li> <li>■ ■ BigDecimal(String)</li> <li>■ ■ BigDecimal(BigInteger)</li> <li>■ ■ BigDecimal(BigInteger,int)</li> <li>■ ■ BigDecimal abs()</li> <li>■ ■ BigDecimal add(BigDecimal)</li> <li>■ ■ int compareTo(Object)</li> <li>■ ■ int compareTo(BigDecimal)</li> <li>■ ■ BigDecimal divide(BigDecimal,int)</li> <li>■ ■ BigDecimal divide(BigDecimal,int,int)</li> <li>■ ■ double doubleValue()</li> <li>■ ■ float floatValue()</li> <li>■ ■ int intValue()</li> <li>■ ■ long longValue()</li> <li>■ ■ BigDecimal max(BigDecimal)</li> <li>■ ■ BigDecimal min(BigDecimal)</li> <li>■ ■ BigDecimal movePointLeft(int)</li> <li>■ ■ BigDecimal movePointRight(int)</li> <li>■ ■ BigDecimal multiply(BigDecimal)</li> </ul>	<ul style="list-style-type: none"> <li>■ ■ BigDecimal negate()</li> <li>■ ■ final static int ROUND_CEILING</li> <li>■ ■ final static int ROUND_DOWN</li> <li>■ ■ final static int ROUND_FLOOR</li> <li>■ ■ final static int ROUND_HALF_DOWN</li> <li>■ ■ final static int ROUND_HALF_EVEN</li> <li>■ ■ final static int ROUND_HALF_UP</li> <li>■ ■ final static int ROUND_UNNECESSARY</li> <li>■ ■ final static int ROUND_UP</li> <li>■ ■ int scale()</li> <li>■ ■ BigDecimal setScale(int)</li> <li>■ ■ BigDecimal setScale(int,int)</li> <li>■ ■ int signum()</li> <li>■ ■ BigDecimal subtract(BigDecimal)</li> <li>■ ■ BigInteger toBigInteger()</li> <li>■ ■ BigInteger unscaledValue()</li> <li>■ ■ static BigDecimal valueOf(long)</li> <li>■ ■ static BigDecimal valueOf(long,int)</li> </ul>
<ul style="list-style-type: none"> <li>■ ■ <b>class BigInteger extends Number implements Comparable</b></li> <li>■ ■ BigInteger(byte[])</li> <li>■ ■ BigInteger(int,byte[])</li> <li>■ ■ BigInteger(int,int,java.util.Random)</li> <li>■ ■ BigInteger(int,java.util.Random)</li> <li>■ ■ BigInteger(String)</li> <li>■ ■ BigInteger(String,int)</li> <li>■ ■ BigInteger abs()</li> <li>■ ■ BigInteger add(BigInteger)</li> <li>■ ■ BigInteger and(BigInteger)</li> <li>■ ■ BigInteger andNot(BigInteger)</li> <li>■ ■ int bitCount()</li> <li>■ ■ int bitLength()</li> <li>■ ■ BigInteger clearBit(int)</li> <li>■ ■ int compareTo(Object)</li> <li>■ ■ int compareTo(BigInteger)</li> <li>■ ■ BigInteger divide(BigInteger)</li> <li>■ ■ BigInteger[] divideAndRemainder(BigInteger)</li> <li>■ ■ double doubleValue()</li> <li>■ ■ BigInteger flipBit(int)</li> <li>■ ■ float floatValue()</li> <li>■ ■ BigInteger gcd(BigInteger)</li> <li>■ ■ int getLowestSetBit()</li> <li>■ ■ int intValue()</li> <li>■ ■ boolean isProbablePrime(int)</li> </ul>	<ul style="list-style-type: none"> <li>■ ■ long longValue()</li> <li>■ ■ BigInteger max(BigInteger)</li> <li>■ ■ BigInteger min(BigInteger)</li> <li>■ ■ BigInteger mod(BigInteger)</li> <li>■ ■ BigInteger modInverse(BigInteger)</li> <li>■ ■ BigInteger modPow(BigInteger,BigInteger)</li> <li>■ ■ BigInteger multiply(BigInteger)</li> <li>■ ■ BigInteger negate()</li> <li>■ ■ BigInteger not()</li> <li>■ ■ final static BigInteger ONE</li> <li>■ ■ BigInteger or(BigInteger)</li> <li>■ ■ BigInteger pow(int)</li> <li>■ ■ BigInteger remainder(BigInteger)</li> <li>■ ■ BigInteger setBit(int)</li> <li>■ ■ BigInteger shiftLeft(int)</li> <li>■ ■ BigInteger shiftRight(int)</li> <li>■ ■ int signum()</li> <li>■ ■ BigInteger subtract(BigInteger)</li> <li>■ ■ boolean testBit(int)</li> <li>■ ■ byte[] toByteArray()</li> <li>■ ■ String toString(int)</li> <li>■ ■ static BigInteger valueOf(long)</li> <li>■ ■ BigInteger xor(BigInteger)</li> <li>■ ■ final static BigInteger ZERO</li> </ul>

---

## 999.3.6

## java.net

<b>package java.net</b>	
<b>abstract class Authenticator</b>	
<ul style="list-style-type: none"> <li>■ Authenticator()</li> <li>■ protected PasswordAuthentication getPasswordAuthentication()</li> <li>■ final protected String getRequestingHost()</li> <li>■ final protected int getRequestingPort()</li> <li>■ final protected String getRequestingPrompt()</li> <li>■ final protected String getRequestingProtocol()</li> </ul>	<ul style="list-style-type: none"> <li>■ final protected String getRequestingScheme()</li> <li>■ final protected InetAddress getRequestingSite()</li> <li>■ static PasswordAuthentication requestPasswordAuthentication(String, InetAddress, int, String, String)</li> <li>■ static PasswordAuthentication requestPasswordAuthentication(InetAddress, int, String, String, String)</li> <li>■ static void setDefault(Authenticator)</li> </ul>
<b>class BindException extends SocketException</b>	
<ul style="list-style-type: none"> <li>■ BindException()</li> </ul>	<ul style="list-style-type: none"> <li>■ BindException(String)</li> </ul>
<b>class ConnectException extends SocketException</b>	
<ul style="list-style-type: none"> <li>■ ConnectException()</li> </ul>	<ul style="list-style-type: none"> <li>■ ConnectException(String)</li> </ul>
<b>abstract class ContentHandler</b>	
<ul style="list-style-type: none"> <li>■ ContentHandler()</li> <li>■ abstract Object getContent(URLConnection)</li> </ul> <p>throws java.io.IOException</p>	<ul style="list-style-type: none"> <li>■ Object getContent(URLConnection, Class[])</li> </ul> <p>throws java.io.IOException</p>
<b>interface ContentHandlerFactory</b>	
<ul style="list-style-type: none"> <li>■ abstract ContentHandler createContentHandler(String)</li> </ul>	
<b>final class DatagramPacket</b>	
<ul style="list-style-type: none"> <li>■ DatagramPacket(byte[], int)</li> <li>■ DatagramPacket(byte[], int, int)</li> <li>■ DatagramPacket(byte[], int, int, InetAddress, int)</li> <li>■ DatagramPacket(byte[], int, int, SocketAddress)</li> </ul> <p>throws SocketException</p> <ul style="list-style-type: none"> <li>■ DatagramPacket(byte[], int, InetAddress, int)</li> <li>■ DatagramPacket(byte[], int, SocketAddress) throws SocketException</li> </ul> <ul style="list-style-type: none"> <li>■ InetAddress getAddress()</li> <li>■ byte[] getData()</li> <li>■ int getLength()</li> </ul>	<ul style="list-style-type: none"> <li>■ int getOffset()</li> <li>■ int getPort()</li> <li>■ SocketAddress getSocketAddress()</li> <li>■ void setAddress(InetAddress)</li> <li>■ void setData(byte[])</li> <li>■ void setData(byte[], int, int)</li> <li>■ void setLength(int)</li> <li>■ void setPort(int)</li> <li>■ void setSocketAddress(SocketAddress)</li> </ul>
<b>class DatagramSocket</b>	
<ul style="list-style-type: none"> <li>■ DatagramSocket() throws SocketException</li> <li>■ DatagramSocket(int) throws SocketException</li> <li>■ DatagramSocket(int, InetAddress) throws SocketException</li> <li>■ protected DatagramSocket(DatagramSocketImpl)</li> <li>■ DatagramSocket(SocketAddress) throws SocketException</li> <li>■ void bind(SocketAddress) throws SocketException</li> <li>■ void close()</li> <li>■ void connect(InetAddress, int)</li> <li>■ void connect(SocketAddress) throws SocketException</li> <li>■ void disconnect()</li> <li>■ boolean getBroadcast() throws SocketException</li> <li>■ InetAddress getInetAddress()</li> <li>■ InetAddress getLocalAddress()</li> <li>■ int getLocalPort()</li> <li>■ SocketAddress getLocalSocketAddress()</li> <li>■ int getPort()</li> <li>■ int getReceiveBufferSize() throws SocketException</li> </ul>	<ul style="list-style-type: none"> <li>■ SocketAddress getRemoteSocketAddress()</li> <li>■ boolean getReuseAddress() throws SocketException</li> <li>■ int getSendBufferSize() throws SocketException</li> <li>■ int getSoTimeout() throws SocketException</li> <li>■ int getTrafficClass() throws SocketException</li> <li>■ boolean isBound()</li> <li>■ boolean isClosed()</li> <li>■ boolean isConnected()</li> <li>■ void receive(DatagramPacket) throws java.io.IOException</li> <li>■ void send(DatagramPacket) throws java.io.IOException</li> <li>■ void setBroadcast(boolean) throws SocketException</li> <li>■ static void setDatagramSocketImplFactory(DatagramSocketImplFactory)</li> <li>■ void setReceiveBufferSize(int) throws SocketException</li> <li>■ void setReuseAddress(boolean) throws SocketException</li> <li>■ void setSendBufferSize(int) throws SocketException</li> <li>■ void setSoTimeout(int) throws SocketException</li> <li>■ void setTrafficClass(int) throws SocketException</li> </ul>
<b>abstract class DatagramSocketImpl implements SocketOptions</b>	
<ul style="list-style-type: none"> <li>■ DatagramSocketImpl()</li> <li>■ abstract protected void bind(int, InetAddress) throws SocketException</li> <li>■ abstract protected void close()</li> <li>■ protected void connect(InetAddress, int) throws SocketException</li> <li>■ abstract protected void create() throws SocketException</li> <li>■ protected void disconnect()</li> <li>■ protected java.io.FileDescriptor fd</li> <li>■ protected java.io.FileDescriptor getFileDescriptor()</li> <li>■ protected int getLocalPort()</li> <li>■ abstract protected int getTimeToLive() throws java.io.IOException</li> </ul>	<ul style="list-style-type: none"> <li>■ abstract protected void join(InetAddress) throws java.io.IOException</li> <li>■ abstract protected void joinGroup(SocketAddress, NetworkInterface) throws java.io.IOException</li> <li>■ abstract protected void leave(InetAddress) throws java.io.IOException</li> <li>■ abstract protected void leaveGroup(SocketAddress, NetworkInterface) throws java.io.IOException</li> <li>■ protected int localPort</li> <li>■ abstract protected int peek(InetAddress) throws java.io.IOException</li> <li>■ abstract protected int peekData(DatagramPacket) throws java.io.IOException</li> <li>■ abstract protected void receive(DatagramPacket) throws java.io.IOException</li> <li>■ abstract protected void send(DatagramPacket) throws java.io.IOException</li> <li>■ abstract protected void setTimeToLive(int) throws java.io.IOException</li> </ul>
<b>interface DatagramSocketImplFactory</b>	
<ul style="list-style-type: none"> <li>■ abstract DatagramSocketImpl createDatagramSocketImpl()</li> </ul>	
<b>interface FileNameMap</b>	
<ul style="list-style-type: none"> <li>■ abstract String getContentTypesFor(String)</li> </ul>	



---

<b>■ ■ abstract class <code>URLConnection</code> extends <code>URLConnection</code></b>	
<ul style="list-style-type: none"> <li>■ ■ protected <code>URLConnection(URL)</code></li> <li>■ ■ abstract void <code>disconnect()</code></li> <li>■ ■ <code>java.io.InputStream</code> <code>getErrorStream()</code></li> <li>■ ■ static boolean <code>getFollowRedirects()</code></li> <li>■ ■ boolean <code>getInstanceFollowRedirects()</code></li> <li>■ ■ String <code>getRequestMethod()</code></li> <li>■ ■ int <code>getResponseCode()</code> throws <code>java.io.IOException</code></li> <li>■ ■ String <code>getResponseMessage()</code> throws <code>java.io.IOException</code></li> <li>■ ■ final static int <code>HTTP_ACCEPTED</code></li> <li>■ ■ final static int <code>HTTP_BAD_GATEWAY</code></li> <li>■ ■ final static int <code>HTTP_BAD_METHOD</code></li> <li>■ ■ final static int <code>HTTP_BAD_REQUEST</code></li> <li>■ ■ final static int <code>HTTP_CLIENT_TIMEOUT</code></li> <li>■ ■ final static int <code>HTTP_CONFLICT</code></li> <li>■ ■ final static int <code>HTTP_CREATED</code></li> <li>■ ■ final static int <code>HTTP_ENTITY_TOO_LARGE</code></li> <li>■ ■ final static int <code>HTTP_FORBIDDEN</code></li> <li>■ ■ final static int <code>HTTP_GATEWAY_TIMEOUT</code></li> <li>■ ■ final static int <code>HTTP_GONE</code></li> <li>■ ■ final static int <code>HTTP_INTERNAL_ERROR</code></li> <li>■ ■ final static int <code>HTTP_LENGTH_REQUIRED</code></li> <li>■ ■ final static int <code>HTTP_MOVED_PERM</code></li> <li>■ ■ final static int <code>HTTP_MOVED_TEMP</code></li> <li>■ ■ final static int <code>HTTP_MULT_CHOICE</code></li> <li>■ ■ final static int <code>HTTP_NO_CONTENT</code></li> <li>■ ■ final static int <code>HTTP_NOT_ACCEPTABLE</code></li> </ul>	<ul style="list-style-type: none"> <li>■ ■ final static int <code>HTTP_NOT_AUTHORITY</code></li> <li>■ ■ final static int <code>HTTP_NOT_FOUND</code></li> <li>■ ■ final static int <code>HTTP_NOT_IMPLEMENTED</code></li> <li>■ ■ final static int <code>HTTP_NOT_MODIFIED</code></li> <li>■ ■ final static int <code>HTTP_OK</code></li> <li>■ ■ final static int <code>HTTP_PARTIAL</code></li> <li>■ ■ final static int <code>HTTP_PAYMENT_REQUIRED</code></li> <li>■ ■ final static int <code>HTTP_PRECON_FAILED</code></li> <li>■ ■ final static int <code>HTTP_PROXY_AUTH</code></li> <li>■ ■ final static int <code>HTTP_REQ_TOO_LONG</code></li> <li>■ ■ final static int <code>HTTP_RESET</code></li> <li>■ ■ final static int <code>HTTP_SEE_OTHER</code></li> <li>■ ■ final static int <code>HTTP_UNAUTHORIZED</code></li> <li>■ ■ final static int <code>HTTP_UNAVAILABLE</code></li> <li>■ ■ final static int <code>HTTP_UNSUPPORTED_TYPE</code></li> <li>■ ■ final static int <code>HTTP_USE_PROXY</code></li> <li>■ ■ final static int <code>HTTP_VERSION</code></li> <li>■ ■ protected boolean <code>instanceFollowRedirects</code></li> <li>■ ■ protected String <code>method</code></li> <li>■ ■ protected int <code>statusCode</code></li> <li>■ ■ protected String <code>responseMessage</code></li> <li>■ ■ static void <code>setFollowRedirects(boolean)</code></li> <li>■ ■ void <code>setInstanceFollowRedirects(boolean)</code></li> <li>■ ■ void <code>setRequestMethod(String)</code> throws <code>ProtocolException</code></li> <li>■ ■ abstract boolean <code>usingProxy()</code></li> </ul>
<b>■ ■ final class <code>InetAddress</code> extends <code>InetAddress</code></b>	
<hr/>	
<b>■ ■ final class <code>Inet6Address</code> extends <code>InetAddress</code></b>	
<ul style="list-style-type: none"> <li>■ ■ boolean <code>isIPv4CompatibleAddress()</code></li> </ul>	
<b>■ ■ class <code>InetAddress</code> implements <code>java.io.Serializable</code></b>	
<ul style="list-style-type: none"> <li>■ ■ byte[] <code>getAddress()</code></li> <li>■ ■ static <code>InetAddress[]</code> <code>getAllByName(String)</code></li> </ul> <p>throws <code>UnknownHostException</code></p> <ul style="list-style-type: none"> <li>■ ■ static <code>InetAddress</code> <code>getByAddress(byte[])</code></li> </ul> <p>throws <code>UnknownHostException</code></p> <ul style="list-style-type: none"> <li>■ ■ static <code>InetAddress</code> <code>getByAddress(String,byte[])</code></li> </ul> <p>throws <code>UnknownHostException</code></p> <ul style="list-style-type: none"> <li>■ ■ static <code>InetAddress</code> <code>getByName(String)</code> throws <code>UnknownHostException</code></li> <li>■ ■ String <code>getCanonicalHostName()</code></li> <li>■ ■ String <code>getHostAddress()</code></li> <li>■ ■ String <code>getHostName()</code></li> <li>■ ■ static <code>InetAddress</code> <code>getLocalHost()</code> throws <code>UnknownHostException</code></li> <li>■ ■ boolean <code>isAnyLocalAddress()</code></li> </ul>	<ul style="list-style-type: none"> <li>■ ■ boolean <code>isLinkLocalAddress()</code></li> <li>■ ■ boolean <code>isLoopbackAddress()</code></li> <li>■ ■ boolean <code>isMCGlobal()</code></li> <li>■ ■ boolean <code>isMCLinkLocal()</code></li> <li>■ ■ boolean <code>isMCNodeLocal()</code></li> <li>■ ■ boolean <code>isMCOrgLocal()</code></li> <li>■ ■ boolean <code>isMCSiteLocal()</code></li> <li>■ ■ boolean <code>isMulticastAddress()</code></li> <li>■ ■ boolean <code>isSiteLocalAddress()</code></li> </ul>
<hr/>	
<b>■ ■ class <code>InetSocketAddress</code> extends <code>SocketAddress</code></b>	
<ul style="list-style-type: none"> <li>■ ■ <code>InetSocketAddress(int)</code></li> <li>■ ■ <code>InetSocketAddress(String,int)</code></li> <li>■ ■ <code>InetSocketAddress(InetAddress,int)</code></li> <li>■ ■ final boolean <code>equals(Object)</code></li> <li>■ ■ final <code>InetAddress</code> <code>getAddress()</code></li> </ul>	<ul style="list-style-type: none"> <li>■ ■ final String <code>getHostName()</code></li> <li>■ ■ final int <code>getPort()</code></li> <li>■ ■ final int <code>hashCode()</code></li> <li>■ ■ final boolean <code>isUnresolved()</code></li> </ul>
<hr/>	
<b>■ ■ abstract class <code>JarURLConnection</code> extends <code>URLConnection</code></b>	
<ul style="list-style-type: none"> <li>■ ■ protected <code>JarURLConnection(URL)</code> throws <code>MalformedURLException</code></li> <li>■ ■ <code>java.util.jar.Attributes</code> <code>getAttributes()</code> throws <code>java.io.IOException</code></li> <li>■ ■ <code>java.security.cert.Certificate[]</code> <code>getCertificates()</code></li> </ul> <p>throws <code>java.io.IOException</code></p> <ul style="list-style-type: none"> <li>■ ■ String <code>getEntryName()</code></li> <li>■ ■ <code>java.util.jar.JarEntry</code> <code>getJarEntry()</code> throws <code>java.io.IOException</code></li> </ul>	<ul style="list-style-type: none"> <li>■ ■ abstract <code>java.util.jar.JarFile</code> <code>getJarFile()</code> throws <code>java.io.IOException</code></li> <li>■ ■ URL <code>getJarFileURL()</code></li> <li>■ ■ <code>java.util.jar.Attributes</code> <code>getMainAttributes()</code> throws <code>java.io.IOException</code></li> <li>■ ■ <code>java.util.jar.Manifest</code> <code>getManifest()</code> throws <code>java.io.IOException</code></li> <li>■ ■ protected <code>URLConnection</code> <code>jarURLConnection</code></li> </ul>
<hr/>	
<b>■ ■ class <code>MalformedURLException</code> extends <code>java.io.IOException</code></b>	
<ul style="list-style-type: none"> <li>■ ■ <code>MalformedURLException()</code></li> </ul>	<ul style="list-style-type: none"> <li>■ ■ <code>MalformedURLException(String)</code></li> </ul>
<hr/>	
<b>■ ■ class <code>MulticastSocket</code> extends <code>DatagramSocket</code></b>	
<ul style="list-style-type: none"> <li>■ ■ <code>MulticastSocket()</code> throws <code>java.io.IOException</code></li> <li>■ ■ <code>MulticastSocket(int)</code> throws <code>java.io.IOException</code></li> <li>■ ■ <code>MulticastSocket(SocketAddress)</code> throws <code>java.io.IOException</code></li> <li>■ ■ <code>InetAddress</code> <code>getInterface()</code> throws <code>SocketException</code></li> <li>■ ■ boolean <code>getLoopbackMode()</code> throws <code>SocketException</code></li> <li>■ ■ <code>NetworkInterface</code> <code>getNetworkInterface()</code> throws <code>SocketException</code></li> <li>■ ■ int <code>getTimeToLive()</code> throws <code>java.io.IOException</code></li> <li>■ ■ void <code>joinGroup(InetAddress)</code> throws <code>java.io.IOException</code></li> </ul>	<ul style="list-style-type: none"> <li>■ ■ void <code>joinGroup(SocketAddress,NetworkInterface)</code> throws <code>java.io.IOException</code></li> <li>■ ■ void <code>leaveGroup(InetAddress)</code> throws <code>java.io.IOException</code></li> <li>■ ■ void <code>leaveGroup(SocketAddress,NetworkInterface)</code> throws <code>java.io.IOException</code></li> <li>■ ■ void <code>send(DatagramPacket,byte)</code> throws <code>java.io.IOException</code></li> <li>■ ■ void <code>setInterface(InetAddress)</code> throws <code>SocketException</code></li> <li>■ ■ void <code>setLoopbackMode(boolean)</code> throws <code>SocketException</code></li> <li>■ ■ void <code>setNetworkInterface(NetworkInterface)</code> throws <code>SocketException</code></li> <li>■ ■ void <code>setTimeToLive(int)</code> throws <code>java.io.IOException</code></li> </ul>
<hr/>	
<b>■ ■ final class <code>NetPermission</code> extends <code>java.security.BasicPermission</code></b>	
<ul style="list-style-type: none"> <li>■ ■ <code>NetPermission(String)</code></li> </ul>	<ul style="list-style-type: none"> <li>■ ■ <code>NetPermission(String,String)</code></li> </ul>

---

<ul style="list-style-type: none"> <li>■ ■ <b>final class <code>NetworkInterface</code></b></li> <li>■ ■ <code>static NetworkInterface getByNetAddress(InetAddress)</code> throws <code>SocketException</code></li> <li>■ ■ <code>static NetworkInterface getName(String)</code> throws <code>SocketException</code></li> <li>■ ■ <code>String getDisplayName()</code></li> </ul>	<ul style="list-style-type: none"> <li>■ ■ <code>java.util.Enumeration getNetAddresses()</code></li> <li>■ ■ <code>String getName()</code></li> <li>■ ■ <code>static java.util.Enumeration getNetworkInterfaces()</code> throws <code>SocketException</code></li> </ul>
<ul style="list-style-type: none"> <li>■ ■ <b>class <code>NoRouteToHostException</code> extends <code>SocketException</code></b></li> <li>■ ■ <code>NoRouteToHostException()</code></li> </ul>	<ul style="list-style-type: none"> <li>■ ■ <code>NoRouteToHostException(String)</code></li> </ul>
<ul style="list-style-type: none"> <li>■ ■ <b>final class <code>PasswordAuthentication</code></b></li> <li>■ ■ <code>PasswordAuthentication(String, char[])</code></li> <li>■ ■ <code>char[] getPassword()</code></li> </ul>	<ul style="list-style-type: none"> <li>■ ■ <code>String getUserName()</code></li> </ul>
<ul style="list-style-type: none"> <li>■ ■ <b>class <code>PortUnreachableException</code> extends <code>SocketException</code></b></li> <li>■ ■ <code>PortUnreachableException()</code></li> </ul>	<ul style="list-style-type: none"> <li>■ ■ <code>PortUnreachableException(String)</code></li> </ul>
<ul style="list-style-type: none"> <li>■ ■ <b>class <code>ProtocolException</code> extends <code>java.io.IOException</code></b></li> <li>■ ■ <code>ProtocolException()</code></li> </ul>	<ul style="list-style-type: none"> <li>■ ■ <code>ProtocolException(String)</code></li> </ul>
<ul style="list-style-type: none"> <li>■ ■ <b>class <code>ServerSocket</code></b></li> <li>■ ■ <code>ServerSocket()</code> throws <code>java.io.IOException</code></li> <li>■ ■ <code>ServerSocket(int)</code> throws <code>java.io.IOException</code></li> <li>■ ■ <code>ServerSocket(int, int)</code> throws <code>java.io.IOException</code></li> <li>■ ■ <code>ServerSocket(int, int, InetAddress)</code> throws <code>java.io.IOException</code></li> <li>■ ■ <code>Socket accept()</code> throws <code>java.io.IOException</code></li> <li>■ ■ <code>void bind(SocketAddress)</code> throws <code>java.io.IOException</code></li> <li>■ ■ <code>void bind(SocketAddress, int)</code> throws <code>java.io.IOException</code></li> <li>■ ■ <code>void close()</code> throws <code>java.io.IOException</code></li> <li>■ ■ <code>InetAddress getInetAddress()</code></li> <li>■ ■ <code>int getLocalPort()</code></li> <li>■ ■ <code>SocketAddress getLocalSocketAddress()</code></li> </ul>	<ul style="list-style-type: none"> <li>■ ■ <code>int getReceiveBufferSize()</code> throws <code>SocketException</code></li> <li>■ ■ <code>boolean getReuseAddress()</code> throws <code>SocketException</code></li> <li>■ ■ <code>int getSoTimeout()</code> throws <code>java.io.IOException</code></li> <li>■ ■ <code>final protected void implAccept(Socket)</code> throws <code>java.io.IOException</code></li> <li>■ ■ <code>boolean isBound()</code></li> <li>■ ■ <code>boolean isClosed()</code></li> <li>■ ■ <code>void setReceiveBufferSize(int)</code> throws <code>SocketException</code></li> <li>■ ■ <code>void setReuseAddress(boolean)</code> throws <code>SocketException</code></li> <li>■ ■ <code>static void setSocketFactory(SocketImplFactory)</code> throws <code>java.io.IOException</code></li> <li>■ ■ <code>void setSoTimeout(int)</code> throws <code>SocketException</code></li> </ul>
<ul style="list-style-type: none"> <li>■ ■ <b>class <code>Socket</code></b></li> <li>■ ■ <code>Socket()</code></li> <li>■ ■ <code>Socket(String, int)</code> throws <code>java.io.IOException</code></li> <li>■ ■ <code>Socket(String, int, InetAddress, int)</code> throws <code>java.io.IOException</code></li> <li>■ ■ <code>Socket(InetAddress, int)</code> throws <code>java.io.IOException</code></li> <li>■ ■ <code>Socket(InetAddress, int, InetAddress, int)</code> throws <code>java.io.IOException</code></li> <li>■ ■ <code>protected Socket(SocketImpl)</code> throws <code>SocketException</code></li> <li>■ ■ <code>void bind(SocketAddress)</code> throws <code>java.io.IOException</code></li> <li>■ ■ <code>void close()</code> throws <code>java.io.IOException</code></li> <li>■ ■ <code>void connect(SocketAddress)</code> throws <code>java.io.IOException</code></li> <li>■ ■ <code>void connect(SocketAddress, int)</code> throws <code>java.io.IOException</code></li> <li>■ ■ <code>InetAddress getInetAddress()</code></li> <li>■ ■ <code>java.io.InputStream getInputStream()</code> throws <code>java.io.IOException</code></li> <li>■ ■ <code>boolean getKeepAlive()</code> throws <code>SocketException</code></li> <li>■ ■ <code>InetAddress getLocalAddress()</code></li> <li>■ ■ <code>int getLocalPort()</code></li> <li>■ ■ <code>SocketAddress getLocalSocketAddress()</code></li> <li>■ ■ <code>boolean getOOBInline()</code> throws <code>SocketException</code></li> <li>■ ■ <code>java.io.OutputStream getOutputStream()</code> throws <code>java.io.IOException</code></li> <li>■ ■ <code>int getPort()</code></li> <li>■ ■ <code>int getReceiveBufferSize()</code> throws <code>SocketException</code></li> <li>■ ■ <code>SocketAddress getRemoteSocketAddress()</code></li> <li>■ ■ <code>boolean getReuseAddress()</code> throws <code>SocketException</code></li> <li>■ ■ <code>int getSendBufferSize()</code> throws <code>SocketException</code></li> </ul>	<ul style="list-style-type: none"> <li>■ ■ <code>int getSoLinger()</code> throws <code>SocketException</code></li> <li>■ ■ <code>int getSoTimeout()</code> throws <code>SocketException</code></li> <li>■ ■ <code>boolean getTcpNoDelay()</code> throws <code>SocketException</code></li> <li>■ ■ <code>int getTrafficClass()</code> throws <code>SocketException</code></li> <li>■ ■ <code>boolean isBound()</code></li> <li>■ ■ <code>boolean isClosed()</code></li> <li>■ ■ <code>boolean isConnected()</code></li> <li>■ ■ <code>boolean isInputShutdown()</code></li> <li>■ ■ <code>boolean isOutputShutdown()</code></li> <li>■ ■ <code>void sendUrgentData(int)</code> throws <code>java.io.IOException</code></li> <li>■ ■ <code>void setKeepAlive(boolean)</code> throws <code>SocketException</code></li> <li>■ ■ <code>void setOOBInline(boolean)</code> throws <code>SocketException</code></li> <li>■ ■ <code>void setReceiveBufferSize(int)</code> throws <code>SocketException</code></li> <li>■ ■ <code>void setReuseAddress(boolean)</code> throws <code>SocketException</code></li> <li>■ ■ <code>void setSendBufferSize(int)</code> throws <code>SocketException</code></li> <li>■ ■ <code>static void setSocketImplFactory(SocketImplFactory)</code> throws <code>java.io.IOException</code></li> <li>■ ■ <code>void setSoLinger(boolean, int)</code> throws <code>SocketException</code></li> <li>■ ■ <code>void setSoTimeout(int)</code> throws <code>SocketException</code></li> <li>■ ■ <code>void setTcpNoDelay(boolean)</code> throws <code>SocketException</code></li> <li>■ ■ <code>void setTrafficClass(int)</code> throws <code>SocketException</code></li> <li>■ ■ <code>void shutdownInput()</code> throws <code>java.io.IOException</code></li> <li>■ ■ <code>void shutdownOutput()</code> throws <code>java.io.IOException</code></li> </ul>
<ul style="list-style-type: none"> <li>■ ■ <b>abstract class <code>SocketAddress</code> implements <code>java.io.Serializable</code></b></li> <li>■ ■ <code>SocketAddress()</code></li> </ul>	
<ul style="list-style-type: none"> <li>■ ■ <b>class <code>SocketException</code> extends <code>java.io.IOException</code></b></li> <li>■ ■ <code>SocketException()</code></li> </ul>	<ul style="list-style-type: none"> <li>■ ■ <code>SocketException(String)</code></li> </ul>
<ul style="list-style-type: none"> <li>■ ■ <b>abstract class <code>SocketImpl</code> implements <code>SocketOptions</code></b></li> <li>■ ■ <code>SocketImpl()</code></li> <li>■ ■ <code>abstract protected void accept(SocketImpl)</code> throws <code>java.io.IOException</code></li> <li>■ ■ <code>protected InetAddress address</code></li> <li>■ ■ <code>abstract protected int available()</code> throws <code>java.io.IOException</code></li> <li>■ ■ <code>abstract protected void bind(InetAddress, int)</code> throws <code>java.io.IOException</code></li> <li>■ ■ <code>abstract protected void close()</code> throws <code>java.io.IOException</code></li> <li>■ ■ <code>abstract protected void connect(String, int)</code> throws <code>java.io.IOException</code></li> <li>■ ■ <code>abstract protected void connect(InetAddress, int)</code> throws <code>java.io.IOException</code></li> <li>■ ■ <code>abstract protected void connect(SocketAddress, int)</code> throws <code>java.io.IOException</code></li> <li>■ ■ <code>abstract protected void create(boolean)</code> throws <code>java.io.IOException</code></li> <li>■ ■ <code>protected java.io.FileDescriptor fd</code></li> <li>■ ■ <code>protected java.io.FileDescriptor getFileDescriptor()</code></li> </ul>	<ul style="list-style-type: none"> <li>■ ■ <code>protected InetAddress getInetAddress()</code></li> <li>■ ■ <code>abstract protected java.io.InputStream getInputStream()</code> throws <code>java.io.IOException</code></li> <li>■ ■ <code>protected int getLocalPort()</code></li> <li>■ ■ <code>abstract protected java.io.OutputStream getOutputStream()</code> throws <code>java.io.IOException</code></li> <li>■ ■ <code>protected int getPort()</code></li> <li>■ ■ <code>abstract protected void listen(int)</code> throws <code>java.io.IOException</code></li> <li>■ ■ <code>protected int localport</code></li> <li>■ ■ <code>protected int port</code></li> <li>■ ■ <code>abstract protected void sendUrgentData(int)</code> throws <code>java.io.IOException</code></li> <li>■ ■ <code>protected void shutdownInput()</code> throws <code>java.io.IOException</code></li> <li>■ ■ <code>protected void shutdownOutput()</code> throws <code>java.io.IOException</code></li> <li>■ ■ <code>protected boolean supportsUrgentData()</code></li> </ul>
<ul style="list-style-type: none"> <li>■ ■ <b>interface <code>SocketImplFactory</code></b></li> </ul>	

<ul style="list-style-type: none"> <li>■ ■ abstract SocketImpl createSocketImpl()</li> </ul>	
<ul style="list-style-type: none"> <li>■ ■ <b>interface SocketOptions</b></li> </ul>	
<ul style="list-style-type: none"> <li>■ ■ abstract Object getOption(int) throws SocketException</li> <li>■ ■ final static int IP_MULTICAST_IF</li> <li>■ ■ final static int IP_MULTICAST_IF2</li> <li>■ ■ final static int IP_MULTICAST_LOOP</li> <li>■ ■ final static int IP_TOS</li> <li>■ ■ abstract void setOption(int,Object) throws SocketException</li> <li>■ ■ final static int SO_BINDADDR</li> <li>■ ■ final static int SO_BROADCAST</li> </ul>	<ul style="list-style-type: none"> <li>■ ■ final static int SO_KEEPALIVE</li> <li>■ ■ final static int SO_LINGER</li> <li>■ ■ final static int SO_OOBINLINE</li> <li>■ ■ final static int SO_RCVBUF</li> <li>■ ■ final static int SO_REUSEADDR</li> <li>■ ■ final static int SO_SNDBUF</li> <li>■ ■ final static int SO_TIMEOUT</li> <li>■ ■ final static int TCP_NODELAY</li> </ul>
<ul style="list-style-type: none"> <li>■ ■ <b>final class SocketPermission extends java.security.Permission implements java.io.Serializable</b></li> </ul>	
<ul style="list-style-type: none"> <li>■ ■ SocketPermission(String,String)</li> <li>■ ■ boolean equals(Object)</li> <li>■ ■ String getActions()</li> </ul>	<ul style="list-style-type: none"> <li>■ ■ int hashCode()</li> <li>■ ■ boolean implies(java.security.Permission)</li> </ul>
<ul style="list-style-type: none"> <li>■ ■ <b>class SocketTimeoutException extends java.io.InterruptedIOException</b></li> </ul>	
<ul style="list-style-type: none"> <li>■ ■ SocketTimeoutException()</li> </ul>	<ul style="list-style-type: none"> <li>■ ■ SocketTimeoutException(String)</li> </ul>
<ul style="list-style-type: none"> <li>■ ■ <b>class UnknownHostException extends java.io.IOException</b></li> </ul>	
<ul style="list-style-type: none"> <li>■ ■ UnknownHostException()</li> </ul>	<ul style="list-style-type: none"> <li>■ ■ UnknownHostException(String)</li> </ul>
<ul style="list-style-type: none"> <li>■ ■ <b>class UnknownServiceException extends java.io.IOException</b></li> </ul>	
<ul style="list-style-type: none"> <li>■ ■ UnknownServiceException()</li> </ul>	<ul style="list-style-type: none"> <li>■ ■ UnknownServiceException(String)</li> </ul>
<ul style="list-style-type: none"> <li>■ ■ <b>final class URI implements java.io.Serializable , Comparable</b></li> </ul>	
<ul style="list-style-type: none"> <li>■ ■ URI(String) throws URISyntaxException</li> <li>■ ■ URI(String,String,String) throws URISyntaxException</li> <li>■ ■ URI(String,String,String,int,String,String,String) throws URISyntaxException</li> </ul>	<ul style="list-style-type: none"> <li>■ ■ String getRawQuery()</li> <li>■ ■ String getRawSchemeSpecificPart()</li> <li>■ ■ String getRawUserInfo()</li> <li>■ ■ String getScheme()</li> <li>■ ■ String getSchemeSpecificPart()</li> <li>■ ■ String getUserInfo()</li> <li>■ ■ boolean isAbsolute()</li> <li>■ ■ boolean isOpaque()</li> <li>■ ■ URI normalize()</li> <li>■ ■ URI parseServerAuthority() throws URISyntaxException</li> <li>■ ■ URI relativize(URI)</li> <li>■ ■ URI resolve(String)</li> <li>■ ■ URI resolve(URI)</li> <li>■ ■ String toASCIIString()</li> <li>■ ■ URL toURL() throws MalformedURLException</li> </ul>
<ul style="list-style-type: none"> <li>throws URISyntaxException</li> <li>■ ■ URI(String,String,String,String) throws URISyntaxException</li> <li>■ ■ URI(String,String,String,String,String) throws URISyntaxException</li> <li>■ ■ int compareTo(Object)</li> <li>■ ■ static URI create(String)</li> <li>■ ■ String getAuthority()</li> <li>■ ■ String getFragment()</li> <li>■ ■ String getHost()</li> <li>■ ■ String getPath()</li> <li>■ ■ int getPort()</li> <li>■ ■ String getQuery()</li> <li>■ ■ String getRawAuthority()</li> <li>■ ■ String getRawFragment()</li> <li>■ ■ String getRawPath()</li> </ul>	
<ul style="list-style-type: none"> <li>■ ■ <b>class URISyntaxException extends Exception</b></li> </ul>	
<ul style="list-style-type: none"> <li>■ ■ URISyntaxException(String,String)</li> <li>■ ■ URISyntaxException(String,String,int)</li> <li>■ ■ int getIndex()</li> </ul>	<ul style="list-style-type: none"> <li>■ ■ String getInput()</li> <li>■ ■ String getReason()</li> </ul>
<ul style="list-style-type: none"> <li>■ ■ <b>final class URL implements java.io.Serializable</b></li> </ul>	
<ul style="list-style-type: none"> <li>■ ■ URL(String) throws MalformedURLException</li> <li>■ ■ URL(String,String,int,String) throws MalformedURLException</li> <li>■ ■ URL(String,String,int,String,URLStreamHandler) throws MalformedURLException</li> </ul>	<ul style="list-style-type: none"> <li>■ ■ int getPort()</li> <li>■ ■ String getProtocol()</li> <li>■ ■ String getQuery()</li> <li>■ ■ String getRef()</li> <li>■ ■ String getUserInfo()</li> <li>■ ■ URLConnection openConnection() throws java.io.IOException</li> <li>■ ■ final java.io.InputStream openStream() throws java.io.IOException</li> <li>■ ■ boolean sameFile(URL)</li> <li>■ ■ protected void set(String,String,int,String,String)</li> <li>■ ■ protected void set(String,String,int,String,String,String,String)</li> <li>■ ■ static void setURLStreamHandlerFactory(URLStreamHandlerFactory)</li> <li>■ ■ String toExternalForm()</li> </ul>
<ul style="list-style-type: none"> <li>throws MalformedURLException</li> <li>■ ■ URL(String,String,String) throws MalformedURLException</li> <li>■ ■ URL(URL,String) throws MalformedURLException</li> <li>■ ■ URL(URL,String,URLStreamHandler) throws MalformedURLException</li> <li>■ ■ String getAuthority()</li> <li>■ ■ final Object getContent() throws java.io.IOException</li> <li>■ ■ final Object getContent(Class[]) throws java.io.IOException</li> <li>■ ■ int getDefaultPort()</li> <li>■ ■ String getFile()</li> <li>■ ■ String getHost()</li> <li>■ ■ String getPath()</li> </ul>	
<ul style="list-style-type: none"> <li>■ ■ <b>class URLClassLoader extends java.security.SecureClassLoader</b></li> </ul>	
<ul style="list-style-type: none"> <li>■ ■ URLClassLoader(URL[])</li> <li>■ ■ URLClassLoader(URL[],ClassLoader)</li> <li>■ ■ URLClassLoader(URL[],ClassLoader,URLStreamHandlerFactory)</li> <li>■ ■ protected void addURL(URL)</li> <li>■ ■ protected Package definePackage(String,java.util.jar.Manifest,URL)</li> </ul>	<ul style="list-style-type: none"> <li>■ ■ URL findResource(String)</li> <li>■ ■ java.util.Enumeration findResources(String) throws java.io.IOException</li> <li>■ ■ URL[] getURLs()</li> <li>■ ■ static URLClassLoader newInstance(URL[])</li> <li>■ ■ static URLClassLoader newInstance(URL[],ClassLoader)</li> </ul>
<ul style="list-style-type: none"> <li>■ ■ <b>abstract class URLConnection</b></li> </ul>	

<ul style="list-style-type: none"> <li>■ ■ protected URLConnection(URL)</li> <li>■ ■ void addRequestProperty(String,String)</li> <li>■ ■ protected boolean allowUserInteraction</li> <li>■ ■ abstract void connect() throws java.io.IOException</li> <li>■ ■ protected boolean connected</li> <li>■ ■ protected boolean doInput</li> <li>■ ■ protected boolean doOutput</li> <li>■ ■ boolean getAllowUserInteraction()</li> <li>■ ■ Object getContent() throws java.io.IOException</li> <li>■ ■ Object getContent(Class[]) throws java.io.IOException</li> <li>■ ■ String getContentEncoding()</li> <li>■ ■ int getContentLength()</li> <li>■ ■ String getContentType()</li> <li>■ ■ long getDate()</li> <li>■ ■ static boolean getDefaultAllowUserInteraction()</li> <li>■ ■ boolean getDefaultUseCaches()</li> <li>■ ■ boolean getDoInput()</li> <li>■ ■ boolean getDoOutput()</li> <li>■ ■ long getExpiration()</li> <li>■ ■ static FileNameMap getFileNameMap()</li> <li>■ ■ String getHeaderField(int)</li> <li>■ ■ String getHeaderField(String)</li> <li>■ ■ long getHeaderFieldDate(String,long)</li> <li>■ ■ int getHeaderFieldInt(String,int)</li> <li>■ ■ String getHeaderFieldKey(int)</li> </ul>	<ul style="list-style-type: none"> <li>■ ■ java.util.Map getHeaderFields()</li> <li>■ ■ long getIfModifiedSince()</li> <li>■ ■ java.io.InputStream getInputStream() throws java.io.IOException</li> <li>■ ■ long getLastModified()</li> <li>■ ■ java.io.OutputStream getOutputStream() throws java.io.IOException</li> <li>■ ■ java.security.Permission getPermission() throws java.io.IOException</li> <li>■ ■ java.util.Map getRequestProperties()</li> <li>■ ■ String getRequestProperty(String)</li> <li>■ ■ URL getURL()</li> <li>■ ■ boolean getUseCaches()</li> <li>■ ■ static String guessContentTypeFromName(String)</li> <li>■ ■ static String guessContentTypeFromStream(java.io.InputStream) throws java.io.IOException</li> <li>■ ■ protected long ifModifiedSince</li> <li>■ ■ void setAllowUserInteraction(boolean)</li> <li>■ ■ static void setConnectionFactory(URLConnectionHandlerFactory)</li> <li>■ ■ static void setDefaultAllowUserInteraction(boolean)</li> <li>■ ■ void setDefaultUseCaches(boolean)</li> <li>■ ■ void setDoInput(boolean)</li> <li>■ ■ void setDoOutput(boolean)</li> <li>■ ■ static void setFileNameMap(FileNameMap)</li> <li>■ ■ void setIfModifiedSince(long)</li> <li>■ ■ void setRequestProperty(String,String)</li> <li>■ ■ void setUseCaches(boolean)</li> <li>■ ■ protected URL url</li> <li>■ ■ protected boolean useCaches</li> </ul>
<ul style="list-style-type: none"> <li>■ ■ class URLDecoder</li> <li>■ ■ URLDecoder()</li> <li>■ ■ static String decode(String)</li> </ul>	<ul style="list-style-type: none"> <li>■ ■ static String decode(String,String) throws java.io.UnsupportedEncodingException</li> </ul>
<ul style="list-style-type: none"> <li>■ ■ class URLEncoder</li> <li>■ ■ static String encode(String)</li> </ul>	<ul style="list-style-type: none"> <li>■ ■ static String encode(String,String) throws java.io.UnsupportedEncodingException</li> </ul>
<ul style="list-style-type: none"> <li>■ ■ abstract class URLStreamHandler</li> <li>■ ■ URLStreamHandler()</li> <li>■ ■ protected boolean equals(URL,URL)</li> <li>■ ■ protected int getDefaultPort()</li> <li>■ ■ protected InetAddress getHostAddress(URL)</li> <li>■ ■ protected int hashCode(URL)</li> <li>■ ■ protected boolean hostsEqual(URL,URL)</li> </ul>	<ul style="list-style-type: none"> <li>■ ■ abstract protected URLConnection openConnection(URL) throws java.io.IOException</li> <li>■ ■ protected void parseURL(URL,String,int,int)</li> <li>■ ■ protected boolean sameFile(URL,URL)</li> <li>■ ■ protected void setURL(URL,String,String,int,String,String,String,String) throws java.io.UnsupportedEncodingException</li> <li>■ ■ protected String toExternalForm(URL)</li> </ul>
<ul style="list-style-type: none"> <li>■ ■ interface URLStreamHandlerFactory</li> <li>■ ■ abstract URLStreamHandler createURLStreamHandler(String)</li> </ul>	

## 999.3.7

## java.security

<ul style="list-style-type: none"> <li>■ ■ package java.security</li> </ul>	
<ul style="list-style-type: none"> <li>■ ■ final class AccessControlContext</li> <li>■ ■ AccessControlContext(ProtectionDomain[])</li> <li>■ ■ AccessControlContext(AccessControlContext,DomainCombiner)</li> </ul>	<ul style="list-style-type: none"> <li>■ ■ void checkPermission(Permission)</li> <li>■ ■ DomainCombiner getDomainCombiner()</li> </ul>
<ul style="list-style-type: none"> <li>■ ■ class AccessControlException extends SecurityException</li> <li>■ ■ AccessControlException(String)</li> <li>■ ■ AccessControlException(String,Permission)</li> </ul>	<ul style="list-style-type: none"> <li>■ ■ Permission getPermission()</li> </ul>
<ul style="list-style-type: none"> <li>■ ■ final class AccessController</li> <li>■ ■ static void checkPermission(Permission)</li> <li>■ ■ static Object doPrivileged(PrivilegedAction)</li> <li>■ ■ static Object doPrivileged(PrivilegedAction,AccessControlContext)</li> </ul>	<ul style="list-style-type: none"> <li>■ ■ static Object doPrivileged(PrivilegedExceptionAction) throws PrivilegedActionException</li> <li>■ ■ static Object doPrivileged(PrivilegedExceptionAction,AccessControlContext) throws PrivilegedActionException</li> <li>■ ■ static AccessControlContext getContext()</li> </ul>
<ul style="list-style-type: none"> <li>■ ■ class AlgorithmParameterGenerator</li> <li>■ ■ protected AlgorithmParameterGenerator(AlgorithmParameterGeneratorSpi,Provider,String)</li> <li>■ ■ final AlgorithmParameters generateParameters()</li> <li>■ ■ final String getAlgorithm()</li> <li>■ ■ static AlgorithmParameterGenerator getInstance(String) throws NoSuchAlgorithmException</li> <li>■ ■ static AlgorithmParameterGenerator getInstance(String,String) throws NoSuchAlgorithmException, NoSuchProviderException</li> <li>■ ■ static AlgorithmParameterGenerator getInstance(String,Provider) throws NoSuchAlgorithmException</li> </ul>	<ul style="list-style-type: none"> <li>■ ■ final Provider getProvider()</li> <li>■ ■ final void init(int)</li> <li>■ ■ final void init(int,SecureRandom)</li> <li>■ ■ final void init(AlgorithmParameterSpec) throws InvalidAlgorithmParameterException</li> <li>■ ■ final void init(AlgorithmParameterSpec,SecureRandom) throws InvalidAlgorithmParameterException</li> </ul>
<ul style="list-style-type: none"> <li>■ ■ abstract class AlgorithmParameterGeneratorSpi</li> </ul>	

<ul style="list-style-type: none"> <li>■ ■ AlgorithmParameterGeneratorSpi()</li> <li>■ ■ abstract protected AlgorithmParameters engineGenerateParameters()</li> </ul>	<ul style="list-style-type: none"> <li>■ ■ abstract protected void engineInit(int,SecureRandom)</li> <li>■ ■ abstract protected void engineInit(AlgorithmParameterSpec,SecureRandom) throws InvalidAlgorithmParameterException</li> </ul>
<ul style="list-style-type: none"> <li>■ ■ <b>class AlgorithmParameters</b></li> <li>■ ■ protected AlgorithmParameters(AlgorithmParametersSpi,Provider,String)</li> <li>■ ■ final String getAlgorithm()</li> <li>■ ■ final byte[] getEncoded() throws java.io.IOException</li> <li>■ ■ final byte[] getEncoded(String) throws java.io.IOException</li> <li>■ ■ static AlgorithmParameters getInstance(String)</li> <li>throws NoSuchAlgorithmException</li> <li>■ ■ static AlgorithmParameters getInstance(String,String)</li> <li>throws NoSuchAlgorithmException, NoSuchProviderException</li> <li>■ ■ static AlgorithmParameters getInstance(String,Provider)</li> <li>throws NoSuchAlgorithmException</li> </ul>	<ul style="list-style-type: none"> <li>■ ■ final AlgorithmParameterSpec getParameterSpec(Class) throws InvalidParameterSpecException</li> <li>■ ■ final Provider getProvider()</li> <li>■ ■ final void init(byte[]) throws java.io.IOException</li> <li>■ ■ final void init(byte[],String) throws java.io.IOException</li> <li>■ ■ final void init(AlgorithmParameterSpec)</li> <li>throws InvalidParameterSpecException</li> <li>■ ■ final String toString()</li> </ul>
<ul style="list-style-type: none"> <li>■ ■ <b>abstract class AlgorithmParametersSpi</b></li> <li>■ ■ AlgorithmParametersSpi()</li> <li>■ ■ abstract protected byte[] engineGetEncoded()</li> <li>throws java.io.IOException</li> <li>■ ■ abstract protected byte[] engineGetEncoded(String)</li> <li>throws java.io.IOException</li> <li>■ ■ abstract protected AlgorithmParameterSpec engineGetParameterSpec(Class) throws InvalidParameterSpecException</li> </ul>	<ul style="list-style-type: none"> <li>■ ■ abstract protected void engineInit(byte[]) throws java.io.IOException</li> <li>■ ■ abstract protected void engineInit(byte[],String) throws java.io.IOException</li> <li>■ ■ abstract protected void engineInit(AlgorithmParameterSpec) throws InvalidParameterSpecException</li> <li>■ ■ abstract protected String engineToString()</li> </ul>
<ul style="list-style-type: none"> <li>■ ■ <b>final class AllPermission extends Permission</b></li> <li>■ ■ AllPermission()</li> <li>■ ■ AllPermission(String,String)</li> <li>■ ■ boolean equals(Object)</li> </ul>	<ul style="list-style-type: none"> <li>■ ■ String getActions()</li> <li>■ ■ int hashCode()</li> <li>■ ■ boolean implies(Permission)</li> </ul>
<ul style="list-style-type: none"> <li>■ ■ <b>abstract class BasicPermission extends Permission implements java.io.Serializable</b></li> <li>■ ■ BasicPermission(String)</li> <li>■ ■ BasicPermission(String,String)</li> <li>■ ■ boolean equals(Object)</li> </ul>	<ul style="list-style-type: none"> <li>■ ■ String getActions()</li> <li>■ ■ int hashCode()</li> <li>■ ■ boolean implies(Permission)</li> </ul>
<ul style="list-style-type: none"> <li>■ ■ <b>interface Certificate</b></li> <li>■ ■ abstract void decode(java.io.InputStream) throws java.io.IOException, KeyException</li> <li>■ ■ abstract void encode(java.io.OutputStream)</li> <li>throws java.io.IOException, KeyException</li> <li>■ ■ abstract String getFormat()</li> <li>■ ■ abstract Principal getGuarantor()</li> </ul>	<ul style="list-style-type: none"> <li>■ ■ abstract Principal getPrincipal()</li> <li>■ ■ abstract PublicKey getPublicKey()</li> <li>■ ■ abstract String toString(boolean)</li> </ul>
<ul style="list-style-type: none"> <li>■ ■ <b>class CodeSource implements java.io.Serializable</b></li> <li>■ ■ CodeSource(java.net.URL,Certificate[])</li> <li>■ ■ final Certificate[] getCertificates()</li> </ul>	<ul style="list-style-type: none"> <li>■ ■ final java.net.URL getLocation()</li> <li>■ ■ boolean implies(CodeSource)</li> </ul>
<ul style="list-style-type: none"> <li>■ ■ <b>class DigestException extends GeneralSecurityException</b></li> <li>■ ■ DigestException()</li> </ul>	<ul style="list-style-type: none"> <li>■ ■ DigestException(String)</li> </ul>
<ul style="list-style-type: none"> <li>■ ■ <b>class DigestInputStream extends java.io.FilterInputStream</b></li> <li>■ ■ DigestInputStream(java.io.InputStream,MessageDigest)</li> <li>■ ■ protected MessageDigest digest</li> <li>■ ■ MessageDigest getMessageDigest()</li> </ul>	<ul style="list-style-type: none"> <li>■ ■ void on(boolean)</li> <li>■ ■ void setMessageDigest(MessageDigest)</li> </ul>
<ul style="list-style-type: none"> <li>■ ■ <b>class DigestOutputStream extends java.io.FilterOutputStream</b></li> <li>■ ■ DigestOutputStream(java.io.OutputStream,MessageDigest)</li> <li>■ ■ protected MessageDigest digest</li> <li>■ ■ MessageDigest getMessageDigest()</li> </ul>	<ul style="list-style-type: none"> <li>■ ■ void on(boolean)</li> <li>■ ■ void setMessageDigest(MessageDigest)</li> </ul>
<ul style="list-style-type: none"> <li>■ ■ <b>interface DomainCombiner</b></li> <li>■ ■ abstract ProtectionDomain[] combine(ProtectionDomain[],ProtectionDomain[])</li> </ul>	
<ul style="list-style-type: none"> <li>■ ■ <b>class GeneralSecurityException extends Exception</b></li> <li>■ ■ GeneralSecurityException()</li> </ul>	<ul style="list-style-type: none"> <li>■ ■ GeneralSecurityException(String)</li> </ul>
<ul style="list-style-type: none"> <li>■ ■ <b>interface Guard</b></li> <li>■ ■ abstract void checkGuard(Object)</li> </ul>	
<ul style="list-style-type: none"> <li>■ ■ <b>class GuardedObject implements java.io.Serializable</b></li> <li>■ ■ GuardedObject(Object,Guard)</li> </ul>	<ul style="list-style-type: none"> <li>■ ■ Object getObject()</li> </ul>
<ul style="list-style-type: none"> <li>■ ■ <b>abstract class Identity implements java.io.Serializable , Principal</b></li> <li>■ ■ protected Identity()</li> <li>■ ■ Identity(String)</li> <li>■ ■ Identity(String,IdentityScope) throws KeyManagementException</li> <li>■ ■ void addCertificate(Certificate) throws KeyManagementException</li> <li>■ ■ Certificate[] certificates()</li> <li>■ ■ final boolean equals(Object)</li> <li>■ ■ String getInfo()</li> <li>■ ■ final String getName()</li> </ul>	<ul style="list-style-type: none"> <li>■ ■ PublicKey getPublicKey()</li> <li>■ ■ final IdentityScope getScope()</li> <li>■ ■ protected boolean identityEquals(Identity)</li> <li>■ ■ void removeCertificate(Certificate) throws KeyManagementException</li> <li>■ ■ void setInfo(String)</li> <li>■ ■ void setPublicKey(PublicKey) throws KeyManagementException</li> <li>■ ■ String toString(boolean)</li> </ul>
<ul style="list-style-type: none"> <li>■ ■ <b>abstract class IdentityScope extends Identity</b></li> </ul>	

<ul style="list-style-type: none"> <li>■ ■ protected IdentityScope()</li> <li>■ ■ IdentityScope(String)</li> <li>■ ■ IdentityScope(String,IdentityScope)</li> </ul>	<ul style="list-style-type: none"> <li>■ ■ abstract Identity getIdentity(PublicKey)</li> <li>■ ■ static IdentityScope getSystemScope()</li> <li>■ ■ abstract java.util.Enumeration identities()</li> <li>■ ■ abstract void removeIdentity(Identity)</li> </ul>
<ul style="list-style-type: none"> <li>throws KeyManagementException</li> <li>■ ■ abstract void addIdentity(Identity) throws KeyManagementException</li> <li>■ ■ abstract Identity getIdentity(String)</li> <li>■ ■ Identity getIdentity(Principal)</li> </ul>	<ul style="list-style-type: none"> <li>throws KeyManagementException</li> <li>■ ■ protected static void setSystemScope(IdentityScope)</li> <li>■ ■ abstract int size()</li> </ul>
<hr/>	
<ul style="list-style-type: none"> <li>■ ■ <b>class InvalidAlgorithmParameterException extends GeneralSecurityException</b></li> </ul>	
<ul style="list-style-type: none"> <li>■ ■ InvalidAlgorithmParameterException()</li> </ul>	<ul style="list-style-type: none"> <li>■ ■ InvalidAlgorithmParameterException(String)</li> </ul>
<hr/>	
<ul style="list-style-type: none"> <li>■ ■ <b>class InvalidKeyException extends KeyException</b></li> </ul>	
<ul style="list-style-type: none"> <li>■ ■ InvalidKeyException()</li> </ul>	<ul style="list-style-type: none"> <li>■ ■ InvalidKeyException(String)</li> </ul>
<hr/>	
<ul style="list-style-type: none"> <li>■ ■ <b>class InvalidParameterException extends IllegalArgumentException</b></li> </ul>	
<ul style="list-style-type: none"> <li>■ ■ InvalidParameterException()</li> </ul>	<ul style="list-style-type: none"> <li>■ ■ InvalidParameterException(String)</li> </ul>
<hr/>	
<ul style="list-style-type: none"> <li>■ ■ <b>interface Key extends java.io.Serializable</b></li> </ul>	
<ul style="list-style-type: none"> <li>■ ■ abstract String getAlgorithm()</li> <li>■ ■ abstract byte[] getEncoded()</li> </ul>	<ul style="list-style-type: none"> <li>■ ■ abstract String getFormat()</li> <li>■ ■ final static long serialVersionUID</li> </ul>
<hr/>	
<ul style="list-style-type: none"> <li>■ ■ <b>class KeyException extends GeneralSecurityException</b></li> </ul>	
<ul style="list-style-type: none"> <li>■ ■ KeyException()</li> </ul>	<ul style="list-style-type: none"> <li>■ ■ KeyException(String)</li> </ul>
<hr/>	
<ul style="list-style-type: none"> <li>■ ■ <b>class KeyFactory</b></li> </ul>	
<ul style="list-style-type: none"> <li>■ ■ protected KeyFactory(KeyFactorySpi,Provider,String)</li> <li>■ ■ final PrivateKey generatePrivate(KeySpec)</li> </ul>	<ul style="list-style-type: none"> <li>■ ■ static KeyFactory getInstance(String,String)</li> </ul>
<ul style="list-style-type: none"> <li>throws InvalidKeySpecException</li> <li>■ ■ final PublicKey generatePublic(KeySpec)</li> </ul>	<ul style="list-style-type: none"> <li>throws NoSuchAlgorithmException, NoSuchProviderException</li> <li>■ ■ static KeyFactory getInstance(String,Provider)</li> </ul>
<ul style="list-style-type: none"> <li>throws InvalidKeySpecException</li> <li>■ ■ final String getAlgorithm()</li> <li>■ ■ static KeyFactory getInstance(String)</li> </ul>	<ul style="list-style-type: none"> <li>throws NoSuchAlgorithmException</li> <li>■ ■ final KeySpec getKeySpec(Key,Class) throws InvalidKeySpecException</li> <li>■ ■ final Provider getProvider()</li> <li>■ ■ final Key translateKey(Key) throws InvalidKeyException</li> </ul>
<ul style="list-style-type: none"> <li>throws NoSuchAlgorithmException</li> </ul>	
<hr/>	
<ul style="list-style-type: none"> <li>■ ■ <b>abstract class KeyFactorySpi</b></li> </ul>	
<ul style="list-style-type: none"> <li>■ ■ KeyFactorySpi()</li> <li>■ ■ abstract protected PrivateKey engineGeneratePrivate(KeySpec)</li> </ul>	<ul style="list-style-type: none"> <li>■ ■ abstract protected KeySpec engineGetKeySpec(Key,Class)</li> </ul>
<ul style="list-style-type: none"> <li>throws InvalidKeySpecException</li> <li>■ ■ abstract protected PublicKey engineGeneratePublic(KeySpec)</li> </ul>	<ul style="list-style-type: none"> <li>throws InvalidKeySpecException</li> <li>■ ■ abstract protected Key engineTranslateKey(Key)</li> </ul>
<ul style="list-style-type: none"> <li>throws InvalidKeySpecException</li> </ul>	
<hr/>	
<ul style="list-style-type: none"> <li>■ ■ <b>class KeyManagementException extends KeyException</b></li> </ul>	
<ul style="list-style-type: none"> <li>■ ■ KeyManagementException()</li> </ul>	<ul style="list-style-type: none"> <li>■ ■ KeyManagementException(String)</li> </ul>
<hr/>	
<ul style="list-style-type: none"> <li>■ ■ <b>final class KeyPair implements java.io.Serializable</b></li> </ul>	
<ul style="list-style-type: none"> <li>■ ■ KeyPair(PublicKey,PrivateKey)</li> <li>■ ■ PrivateKey getPrivate()</li> </ul>	<ul style="list-style-type: none"> <li>■ ■ PublicKey getPublic()</li> </ul>
<hr/>	
<ul style="list-style-type: none"> <li>■ ■ <b>abstract class KeyPairGenerator extends KeyPairGeneratorSpi</b></li> </ul>	
<ul style="list-style-type: none"> <li>■ ■ protected KeyPairGenerator(String)</li> <li>■ ■ KeyPair generateKeyPair()</li> <li>■ ■ final KeyPair genKeyPair()</li> <li>■ ■ String getAlgorithm()</li> <li>■ ■ static KeyPairGenerator getInstance(String)</li> </ul>	<ul style="list-style-type: none"> <li>■ ■ static KeyPairGenerator getInstance(String,Provider)</li> </ul>
<ul style="list-style-type: none"> <li>throws NoSuchAlgorithmException</li> <li>■ ■ static KeyPairGenerator getInstance(String,String)</li> </ul>	<ul style="list-style-type: none"> <li>throws NoSuchAlgorithmException, NoSuchProviderException</li> <li>■ ■ final Provider getProvider()</li> <li>■ ■ void initialize(int)</li> <li>■ ■ void initialize(int,SecureRandom)</li> <li>■ ■ void initialize(AlgorithmParameterSpec)</li> </ul>
<ul style="list-style-type: none"> <li>throws NoSuchAlgorithmException, NoSuchProviderException</li> </ul>	<ul style="list-style-type: none"> <li>throws InvalidAlgorithmParameterException</li> </ul>
<hr/>	
<ul style="list-style-type: none"> <li>■ ■ <b>abstract class KeyPairGeneratorSpi</b></li> </ul>	
<ul style="list-style-type: none"> <li>■ ■ KeyPairGeneratorSpi()</li> <li>■ ■ abstract KeyPair generateKeyPair()</li> </ul>	<ul style="list-style-type: none"> <li>■ ■ abstract void initialize(int,SecureRandom)</li> <li>■ ■ void initialize(AlgorithmParameterSpec,SecureRandom)</li> </ul>
	<ul style="list-style-type: none"> <li>throws InvalidAlgorithmParameterException</li> </ul>
<hr/>	
<ul style="list-style-type: none"> <li>■ ■ <b>class KeyStore</b></li> </ul>	
<ul style="list-style-type: none"> <li>■ ■ protected KeyStore(KeyStoreSpi,Provider,String)</li> <li>■ ■ final java.util.Enumeration aliases() throws KeyStoreException</li> <li>■ ■ final boolean containsAlias(String) throws KeyStoreException</li> <li>■ ■ final void deleteEntry(String) throws KeyStoreException</li> <li>■ ■ final Certificate getCertificate(String) throws KeyStoreException</li> <li>■ ■ final String getCertificateAlias(Certificate) throws KeyStoreException</li> <li>■ ■ final Certificate[] getCertificateChain(String)</li> </ul>	<ul style="list-style-type: none"> <li>■ ■ final Key getKey(String,char[]) throws KeyStoreException, NoSuchAlgorithmException, UnrecoverableKeyException</li> <li>■ ■ final Provider getProvider()</li> <li>■ ■ final String getType()</li> <li>■ ■ final boolean isCertificateEntry(String) throws KeyStoreException</li> <li>■ ■ final boolean isKeyEntry(String) throws KeyStoreException</li> <li>■ ■ final void load(java.io.InputStream,char[]) throws java.io.IOException, NoSuchAlgorithmException, CertificateException</li> <li>■ ■ final void setCertificateEntry(String,Certificate)</li> </ul>
<ul style="list-style-type: none"> <li>throws KeyStoreException</li> <li>■ ■ final java.util.Date getCreationDate(String) throws KeyStoreException</li> <li>■ ■ final static String getDefaultType()</li> <li>■ ■ static KeyStore getInstance(String) throws KeyStoreException</li> <li>■ ■ static KeyStore getInstance(String,String) throws KeyStoreException, NoSuchProviderException</li> <li>■ ■ static KeyStore getInstance(String,Provider) throws KeyStoreException</li> </ul>	<ul style="list-style-type: none"> <li>throws KeyStoreException</li> <li>■ ■ final void setKeyEntry(String,byte[],Certificate[]) throws KeyStoreException</li> <li>■ ■ final void setKeyEntry(String,Key,char[],Certificate[]) throws KeyStoreException</li> <li>■ ■ final int size() throws KeyStoreException</li> <li>■ ■ final void store(java.io.OutputStream,char[]) throws java.io.IOException, KeyStoreException, NoSuchAlgorithmException, CertificateException</li> </ul>
<hr/>	
<ul style="list-style-type: none"> <li>■ ■ <b>class KeyStoreException extends GeneralSecurityException</b></li> </ul>	

<ul style="list-style-type: none"> <li>■ ■ KeyStoreException()</li> <li>■ ■ <b>abstract class KeyStoreSpi</b></li> <li>■ ■ KeyStoreSpi()</li> <li>■ ■ abstract java.util.Enumeration engineAliases()</li> <li>■ ■ abstract boolean engineContainsAlias(String)</li> <li>■ ■ abstract void engineDeleteEntry(String) throws KeyStoreException</li> <li>■ ■ abstract Certificate engineGetCertificate(String)</li> <li>■ ■ abstract String engineGetCertificateAlias(Certificate)</li> <li>■ ■ abstract Certificate[] engineGetCertificateChain(String)</li> <li>■ ■ abstract java.util.Date engineGetCreationDate(String)</li> <li>■ ■ abstract Key engineGetKey(String, char[])</li> <li>throws NoSuchAlgorithmException, UnrecoverableKeyException</li> </ul>	<ul style="list-style-type: none"> <li>■ ■ KeyStoreException(String)</li> <li>■ ■ abstract boolean engineGetCertificateEntry(String)</li> <li>■ ■ abstract boolean engineGetKeyEntry(String)</li> <li>■ ■ abstract void engineLoad(java.io.InputStream, char[]) throws java.io.IOException, NoSuchAlgorithmException, CertificateException</li> <li>■ ■ abstract void engineSetCertificateEntry(String, Certificate) throws KeyStoreException</li> <li>■ ■ abstract void engineSetKeyEntry(String, byte[], Certificate[]) throws KeyStoreException</li> <li>■ ■ abstract void engineSetKeyEntry(String, Key, char[], Certificate[]) throws KeyStoreException</li> <li>■ ■ abstract int engineGetSize()</li> <li>■ ■ abstract void engineStore(java.io.OutputStream, char[]) throws java.io.IOException, NoSuchAlgorithmException, CertificateException</li> </ul>
<ul style="list-style-type: none"> <li>■ ■ <b>abstract class MessageDigest extends MessageDigestSpi</b></li> <li>■ ■ protected MessageDigest(String)</li> <li>■ ■ byte[] digest()</li> <li>■ ■ byte[] digest(byte[])</li> <li>■ ■ int digest(byte[], int, int) throws DigestException</li> <li>■ ■ final String getAlgorithm()</li> <li>■ ■ final int getDigestLength()</li> <li>■ ■ static MessageDigest getInstance(String) throws NoSuchAlgorithmException</li> <li>■ ■ static MessageDigest getInstance(String, String) throws NoSuchAlgorithmException, NoSuchProviderException</li> </ul>	<ul style="list-style-type: none"> <li>■ ■ static MessageDigest getInstance(String, Provider) throws NoSuchAlgorithmException</li> <li>■ ■ final Provider getProvider()</li> <li>■ ■ static boolean isEqual(byte[], byte[])</li> <li>■ ■ void reset()</li> <li>■ ■ void update(byte[])</li> <li>■ ■ void update(byte[], int, int)</li> <li>■ ■ void update(byte)</li> </ul>
<ul style="list-style-type: none"> <li>■ ■ <b>abstract class MessageDigestSpi</b></li> <li>■ ■ MessageDigestSpi()</li> <li>■ ■ Object clone() throws CloneNotSupportedException</li> <li>■ ■ abstract protected byte[] engineDigest()</li> <li>■ ■ protected int engineDigest(byte[], int, int) throws DigestException</li> </ul>	<ul style="list-style-type: none"> <li>■ ■ protected int engineGetDigestLength()</li> <li>■ ■ abstract protected void engineReset()</li> <li>■ ■ abstract protected void engineUpdate(byte[], int, int)</li> <li>■ ■ abstract protected void engineUpdate(byte)</li> </ul>
<ul style="list-style-type: none"> <li>■ ■ <b>class NoSuchAlgorithmException extends GeneralSecurityException</b></li> <li>■ ■ NoSuchAlgorithmException()</li> <li>■ ■ NoSuchAlgorithmException(String)</li> </ul>	
<ul style="list-style-type: none"> <li>■ ■ <b>class NoSuchProviderException extends GeneralSecurityException</b></li> <li>■ ■ NoSuchProviderException()</li> <li>■ ■ NoSuchProviderException(String)</li> </ul>	
<ul style="list-style-type: none"> <li>■ ■ <b>abstract class Permission implements java.io.Serializable , Guard</b></li> <li>■ ■ Permission(String)</li> <li>■ ■ void checkGuard(Object)</li> <li>■ ■ abstract boolean equals(Object)</li> <li>■ ■ abstract String getActions()</li> </ul>	<ul style="list-style-type: none"> <li>■ ■ final String getName()</li> <li>■ ■ abstract int hashCode()</li> <li>■ ■ abstract boolean implies(Permission)</li> <li>■ ■ PermissionCollection newPermissionCollection()</li> </ul>
<ul style="list-style-type: none"> <li>■ ■ <b>abstract class PermissionCollection implements java.io.Serializable</b></li> <li>■ ■ PermissionCollection()</li> <li>■ ■ abstract void add(Permission)</li> <li>■ ■ abstract java.util.Enumeration elements()</li> </ul>	<ul style="list-style-type: none"> <li>■ ■ abstract boolean implies(Permission)</li> <li>■ ■ boolean isReadOnly()</li> <li>■ ■ void setReadOnly()</li> </ul>
<ul style="list-style-type: none"> <li>■ ■ <b>final class Permissions extends PermissionCollection implements java.io.Serializable</b></li> <li>■ ■ Permissions()</li> <li>■ ■ void add(Permission)</li> </ul>	<ul style="list-style-type: none"> <li>■ ■ java.util.Enumeration elements()</li> <li>■ ■ boolean implies(Permission)</li> </ul>
<ul style="list-style-type: none"> <li>■ ■ <b>abstract class Policy</b></li> <li>■ ■ Policy()</li> <li>■ ■ abstract PermissionCollection getPermissions(CodeSource)</li> <li>■ ■ PermissionCollection getPermissions(ProtectionDomain)</li> <li>■ ■ static Policy getPolicy()</li> </ul>	<ul style="list-style-type: none"> <li>■ ■ boolean implies(ProtectionDomain, Permission)</li> <li>■ ■ abstract void refresh()</li> <li>■ ■ static void setPolicy(Policy)</li> </ul>
<ul style="list-style-type: none"> <li>■ ■ <b>interface Principal</b></li> <li>■ ■ abstract boolean equals(Object)</li> <li>■ ■ abstract String getName()</li> </ul>	<ul style="list-style-type: none"> <li>■ ■ abstract int hashCode()</li> <li>■ ■ abstract String toString()</li> </ul>
<ul style="list-style-type: none"> <li>■ ■ <b>interface PrivateKey extends Key</b></li> <li>■ ■ final static long serialVersionUID</li> </ul>	
<ul style="list-style-type: none"> <li>■ ■ <b>interface PrivilegedAction</b></li> <li>■ ■ abstract Object run()</li> </ul>	
<ul style="list-style-type: none"> <li>■ ■ <b>class PrivilegedActionException extends Exception</b></li> <li>■ ■ PrivilegedActionException(Exception)</li> </ul>	<ul style="list-style-type: none"> <li>■ ■ Exception getException()</li> </ul>
<ul style="list-style-type: none"> <li>■ ■ <b>interface PrivilegedExceptionAction</b></li> <li>■ ■ abstract Object run() throws Exception</li> </ul>	
<ul style="list-style-type: none"> <li>■ ■ <b>class ProtectionDomain</b></li> <li>■ ■ ProtectionDomain(CodeSource, PermissionCollection)</li> <li>■ ■ ProtectionDomain(CodeSource, PermissionCollection, ClassLoader, Principal[])</li> <li>■ ■ final ClassLoader getClassLoader()</li> <li>■ ■ final CodeSource getCodeSource()</li> </ul>	<ul style="list-style-type: none"> <li>■ ■ final PermissionCollection getPermissions()</li> <li>■ ■ final Principal[] getPrincipals()</li> <li>■ ■ boolean implies(Permission)</li> </ul>

<ul style="list-style-type: none"> <li>■ ■ <b>abstract class Provider extends java.util.Properties</b></li> <li>■ ■ protected Provider(String,double,String)</li> <li>■ ■ String getInfo()</li> </ul>	<ul style="list-style-type: none"> <li>■ ■ String getName()</li> <li>■ ■ double getVersion()</li> </ul>
<ul style="list-style-type: none"> <li>■ ■ <b>class ProviderException extends RuntimeException</b></li> <li>■ ■ ProviderException()</li> </ul>	<ul style="list-style-type: none"> <li>■ ■ ProviderException(String)</li> </ul>
<ul style="list-style-type: none"> <li>■ ■ <b>interface PublicKey extends Key</b></li> <li>■ ■ final static long serialVersionUID</li> </ul>	
<ul style="list-style-type: none"> <li>■ ■ <b>class SecureClassLoader extends ClassLoader</b></li> <li>■ ■ protected SecureClassLoader()</li> <li>■ ■ protected SecureClassLoader(ClassLoader)</li> </ul>	<ul style="list-style-type: none"> <li>■ ■ final protected Class defineClass(String,byte[],int,int,CodeSource)</li> <li>■ ■ protected PermissionCollection getPermissions(CodeSource)</li> </ul>
<ul style="list-style-type: none"> <li>■ ■ <b>class SecureRandom extends java.util.Random</b></li> <li>■ ■ SecureRandom()</li> <li>■ ■ SecureRandom(byte[])</li> <li>■ ■ protected SecureRandom(SecureRandomSpi,Provider)</li> <li>■ ■ byte[] generateSeed(int)</li> <li>■ ■ static SecureRandom getInstance(String)</li> <li>throws NoSuchAlgorithmException</li> <li>■ ■ static SecureRandom getInstance(String,String)</li> <li>throws NoSuchAlgorithmException, NoSuchProviderException</li> </ul>	<ul style="list-style-type: none"> <li>■ ■ static SecureRandom getInstance(String,Provider)</li> <li>throws NoSuchAlgorithmException</li> <li>■ ■ final Provider getProvider()</li> <li>■ ■ static byte[] getSeed(int)</li> <li>■ ■ final protected int next(int)</li> <li>■ ■ void setSeed(byte[])</li> </ul>
<ul style="list-style-type: none"> <li>■ ■ <b>abstract class SecureRandomSpi implements java.io.Serializable</b></li> <li>■ ■ SecureRandomSpi()</li> <li>■ ■ abstract protected byte[] engineGenerateSeed(int)</li> </ul>	<ul style="list-style-type: none"> <li>■ ■ abstract protected void engineNextBytes(byte[])</li> <li>■ ■ abstract protected void engineSetSeed(byte[])</li> </ul>
<ul style="list-style-type: none"> <li>■ ■ <b>final class Security</b></li> <li>■ ■ static int addProvider(Provider)</li> <li>■ ■ static java.util.Set getAlgorithms(String)</li> <li>■ ■ static String getProperty(String)</li> <li>■ ■ static Provider getProvider(String)</li> <li>■ ■ static Provider[] getProviders()</li> </ul>	<ul style="list-style-type: none"> <li>■ ■ static Provider[] getProviders(String)</li> <li>■ ■ static Provider[] getProviders(java.util.Map)</li> <li>■ ■ static int insertProviderAt(Provider,int)</li> <li>■ ■ static void removeProvider(String)</li> <li>■ ■ static void setProperty(String,String)</li> </ul>
<ul style="list-style-type: none"> <li>■ ■ <b>final class SecurityPermission extends BasicPermission</b></li> <li>■ ■ SecurityPermission(String)</li> </ul>	<ul style="list-style-type: none"> <li>■ ■ SecurityPermission(String,String)</li> </ul>
<ul style="list-style-type: none"> <li>■ ■ <b>abstract class Signature extends SignatureSpi</b></li> <li>■ ■ protected Signature(String)</li> <li>■ ■ final String getAlgorithm()</li> <li>■ ■ static Signature getInstance(String)</li> <li>throws NoSuchAlgorithmException</li> <li>■ ■ static Signature getInstance(String,String)</li> <li>throws NoSuchAlgorithmException, NoSuchProviderException</li> <li>■ ■ static Signature getInstance(String,Provider)</li> <li>throws NoSuchAlgorithmException</li> <li>■ ■ final AlgorithmParameters getParameters()</li> <li>■ ■ final Provider getProvider()</li> <li>■ ■ final void initSign(PrivateKey) throws InvalidKeyException</li> <li>■ ■ final void initSign(PrivateKey,SecureRandom)</li> <li>throws InvalidKeyException</li> <li>■ ■ final void initVerify(Certificate) throws InvalidKeyException</li> <li>■ ■ final void initVerify(PublicKey) throws InvalidKeyException</li> <li>■ ■ final void setParameter(AlgorithmParameterSpec)</li> <li>throws InvalidAlgorithmParameterException</li> </ul>	<ul style="list-style-type: none"> <li>■ ■ final protected static int SIGN</li> <li>■ ■ final byte[] sign() throws SignatureException</li> <li>■ ■ final int sign(byte[],int,int) throws SignatureException</li> <li>■ ■ protected int state</li> <li>■ ■ final protected static int UNINITIALIZED</li> <li>■ ■ final void update(byte[]) throws SignatureException</li> <li>■ ■ final void update(byte[],int,int) throws SignatureException</li> <li>■ ■ final void update(byte) throws SignatureException</li> <li>■ ■ final protected static int VERIFY</li> <li>■ ■ final boolean verify(byte[]) throws SignatureException</li> <li>■ ■ final boolean verify(byte[],int,int) throws SignatureException</li> </ul>
<ul style="list-style-type: none"> <li>■ ■ <b>class SignatureException extends GeneralSecurityException</b></li> <li>■ ■ SignatureException()</li> </ul>	<ul style="list-style-type: none"> <li>■ ■ SignatureException(String)</li> </ul>
<ul style="list-style-type: none"> <li>■ ■ <b>abstract class SignatureSpi</b></li> <li>■ ■ SignatureSpi()</li> <li>■ ■ protected SecureRandom appRandom</li> <li>■ ■ Object clone() throws CloneNotSupportedException</li> <li>■ ■ protected AlgorithmParameters engineGetParameters()</li> <li>■ ■ abstract protected void engineInitSign(PrivateKey)</li> <li>throws InvalidKeyException</li> <li>■ ■ protected void engineInitSign(PrivateKey,SecureRandom)</li> <li>throws InvalidKeyException</li> <li>■ ■ abstract protected void engineInitVerify(PublicKey)</li> <li>throws InvalidKeyException</li> </ul>	<ul style="list-style-type: none"> <li>■ ■ protected void engineSetParameter(AlgorithmParameterSpec)</li> <li>throws InvalidAlgorithmParameterException</li> <li>■ ■ abstract protected byte[] engineSign() throws SignatureException</li> <li>■ ■ protected int engineSign(byte[],int,int) throws SignatureException</li> <li>■ ■ abstract protected void engineUpdate(byte[],int,int)</li> <li>throws SignatureException</li> <li>■ ■ abstract protected void engineUpdate(byte)</li> <li>throws SignatureException</li> <li>■ ■ abstract protected boolean engineVerify(byte[])</li> <li>throws SignatureException</li> <li>■ ■ protected boolean engineVerify(byte[],int,int)</li> <li>throws SignatureException</li> </ul>
<ul style="list-style-type: none"> <li>■ ■ <b>final class SignedObject implements java.io.Serializable</b></li> <li>■ ■ SignedObject(java.io.Serializable,PrivateKey,Signature)</li> <li>throws java.io.IOException, InvalidKeyException, SignatureException</li> <li>■ ■ String getAlgorithm()</li> <li>■ ■ Object getObject() throws java.io.IOException, ClassNotFoundException</li> </ul>	<ul style="list-style-type: none"> <li>■ ■ byte[] getSignature()</li> <li>■ ■ boolean verify(PublicKey,Signature) throws InvalidKeyException, SignatureException</li> </ul>
<ul style="list-style-type: none"> <li>■ ■ <b>abstract class Signer extends Identity</b></li> </ul>	



- ■ protected Signer()
- ■ Signer(String)
- ■ Signer(String,IdentityScope) throws KeyManagementException
- ■ **class UnrecoverableKeyException extends GeneralSecurityException**
- ■ UnrecoverableKeyException()
- ■ UnrecoverableKeyException(String)
- ■ **final class UnresolvedPermission extends Permission implements java.io.Serializable**
- ■ UnresolvedPermission(String,String,String,Certificate[])
- ■ boolean equals(Object)
- ■ String getActions()
- ■ PrivateKey getPrivateKey()
- ■ final void setKeyPair(KeyPair) throws KeyException
- ■ int hashCode()
- ■ boolean implies(Permission)

999.3.8

**java.security.acl**

- ■ **package java.security.acl**
- ■ **interface Acl extends Owner**
- ■ abstract boolean addEntry(java.security.Principal,AclEntry) throws NotOwnerException
- ■ abstract boolean checkPermission(java.security.Principal,Permission) throws NotOwnerException
- ■ abstract java.util.Enumeration entries()
- ■ abstract String getName()
- ■ abstract java.util.Enumeration getPermissions(java.security.Principal)
- ■ abstract boolean removeEntry(java.security.Principal,AclEntry) throws NotOwnerException
- ■ abstract void setName(java.security.Principal,String) throws NotOwnerException
- ■ abstract String toString()
- ■ **interface AclEntry extends Cloneable**
- ■ abstract boolean addPermission(Permission)
- ■ abstract boolean checkPermission(Permission)
- ■ abstract Object clone()
- ■ abstract java.security.Principal getPrincipal()
- ■ abstract boolean isNegative()
- ■ abstract java.util.Enumeration permissions()
- ■ abstract boolean removePermission(Permission)
- ■ abstract void setNegativePermissions()
- ■ abstract boolean setPrincipal(java.security.Principal)
- ■ abstract String toString()
- ■ **class AclNotFoundException extends Exception**
- ■ AclNotFoundException()
- ■ **interface Group extends java.security.Principal**
- ■ abstract boolean addMember(java.security.Principal)
- ■ abstract boolean isMember(java.security.Principal)
- ■ abstract java.util.Enumeration members()
- ■ abstract boolean removeMember(java.security.Principal)
- ■ **class LastOwnerException extends Exception**
- ■ LastOwnerException()
- ■ **class NotOwnerException extends Exception**
- ■ NotOwnerException()
- ■ **interface Owner**
- ■ abstract boolean addOwner(java.security.Principal,java.security.Principal) throws NotOwnerException
- ■ abstract boolean deleteOwner(java.security.Principal,java.security.Principal) throws LastOwnerException, NotOwnerException
- ■ abstract boolean isOwner(java.security.Principal)
- ■ **interface Permission**
- ■ abstract boolean equals(Object)
- ■ abstract String toString()

999.3.9

**java.security.cert**

- ■ **package java.security.cert**
- ■ **abstract class Certificate implements java.io.Serializable**
- ■ protected Certificate(String)
- ■ abstract byte[] getEncoded() throws CertificateEncodingException
- ■ abstract java.security.PublicKey getPublicKey()
- ■ final String getType()
- ■ abstract String toString()
- ■ abstract void verify(java.security.PublicKey) throws java.security.InvalidKeyException, java.security.NoSuchAlgorithmExceptionException, java.security.NoSuchProviderException, java.security.SignatureException, CertificateException
- ■ abstract void verify(java.security.PublicKey,String) throws java.security.InvalidKeyException, java.security.NoSuchAlgorithmExceptionException, java.security.NoSuchProviderException, java.security.SignatureException, CertificateException
- ■ protected Object writeReplace() throws java.io.ObjectStreamException
- ■ **class Certificate.CertificateRep implements java.io.Serializable**
- ■ protected Certificate.CertificateRep(String,byte[])
- ■ protected Object readResolve() throws java.io.ObjectStreamException
- ■ **class CertificateEncodingException extends CertificateException**
- ■ CertificateEncodingException()
- ■ CertificateEncodingException(String)
- ■ **class CertificateException extends java.security.GeneralSecurityException**
- ■ CertificateException()
- ■ CertificateException(String)
- ■ **class CertificateExpiredException extends CertificateException**
- ■ CertificateExpiredException()
- ■ CertificateExpiredException(String)
- ■ **class CertificateFactory**

<ul style="list-style-type: none"> <li>■ ■ protected CertificateFactory(CertificateFactorySpi, java.security.Provider,String)</li> <li>■ ■ final Certificate generateCertificate(java.io.InputStream) throws CertificateException</li> <li>■ ■ final java.util.Collection generateCertificates(java.io.InputStream) throws CertificateException</li> <li>■ ■ final CertPath generateCertPath(java.io.InputStream) throws CertificateException</li> <li>■ ■ final CertPath generateCertPath(java.io.InputStream,String) throws CertificateException</li> <li>■ ■ final CertPath generateCertPath(java.util.List) throws CertificateException</li> <li>■ ■ final CRL generateCRL(java.io.InputStream) throws CRLException</li> </ul>	<ul style="list-style-type: none"> <li>■ ■ final java.util.Collection generateCRLs(java.io.InputStream) throws CRLException</li> <li>■ ■ final java.util.Iterator getCertPathEncodings()</li> <li>■ ■ final static CertificateFactory getInstance(String) throws CertificateException</li> <li>■ ■ final static CertificateFactory getInstance(String,String) throws java.security.NoSuchProviderException, CertificateException</li> <li>■ ■ final static CertificateFactory getInstance(String,java.security.Provider) throws CertificateException</li> <li>■ ■ final java.security.Provider getProvider()</li> <li>■ ■ final String getType()</li> </ul>
<ul style="list-style-type: none"> <li>■ ■ <b>abstract class CertificateFactorySpi</b></li> <li>■ ■ CertificateFactorySpi()</li> <li>■ ■ abstract Certificate engineGenerateCertificate(java.io.InputStream) throws CertificateException</li> <li>■ ■ abstract java.util.Collection engineGenerateCertificates(java.io.InputStream) throws CertificateException</li> <li>■ ■ CertPath engineGenerateCertPath(java.io.InputStream) throws CertificateException</li> <li>■ ■ CertPath engineGenerateCertPath(java.io.InputStream,String) throws CertificateException</li> </ul>	<ul style="list-style-type: none"> <li>■ ■ CertPath engineGenerateCertPath(java.util.List) throws CertificateException</li> <li>■ ■ abstract CRL engineGenerateCRL(java.io.InputStream) throws CRLException</li> <li>■ ■ abstract java.util.Collection engineGenerateCRLs(java.io.InputStream) throws CRLException</li> <li>■ ■ java.util.Iterator engineGetCertPathEncodings()</li> </ul>
<ul style="list-style-type: none"> <li>■ ■ <b>class CertificateNotYetValidException extends CertificateException</b></li> <li>■ ■ CertificateNotYetValidException()</li> </ul>	<ul style="list-style-type: none"> <li>■ ■ CertificateNotYetValidException(String)</li> </ul>
<ul style="list-style-type: none"> <li>■ ■ <b>class CertificateParsingException extends CertificateException</b></li> <li>■ ■ CertificateParsingException()</li> </ul>	<ul style="list-style-type: none"> <li>■ ■ CertificateParsingException(String)</li> </ul>
<ul style="list-style-type: none"> <li>■ ■ <b>abstract class CertPath implements java.io.Serializable</b></li> <li>■ ■ protected CertPath(String)</li> <li>■ ■ abstract java.util.List getCertificates()</li> <li>■ ■ abstract byte[] getEncoded() throws CertificateEncodingException</li> <li>■ ■ abstract byte[] getEncoded(String) throws CertificateEncodingException</li> </ul>	<ul style="list-style-type: none"> <li>■ ■ abstract java.util.Iterator getEncodings()</li> <li>■ ■ String getType()</li> <li>■ ■ protected Object writeReplace() throws java.io.ObjectStreamException</li> </ul>
<ul style="list-style-type: none"> <li>■ ■ <b>class CertPath.CertPathRep implements java.io.Serializable</b></li> <li>■ ■ protected CertPath.CertPathRep(String,byte[])</li> </ul>	<ul style="list-style-type: none"> <li>■ ■ protected Object readResolve() throws java.io.ObjectStreamException</li> </ul>
<ul style="list-style-type: none"> <li>■ ■ <b>abstract class CRL</b></li> <li>■ ■ protected CRL(String)</li> <li>■ ■ final String getType()</li> </ul>	<ul style="list-style-type: none"> <li>■ ■ abstract boolean isRevoked(Certificate)</li> <li>■ ■ abstract String toString()</li> </ul>
<ul style="list-style-type: none"> <li>■ ■ <b>class CRLException extends java.security.GeneralSecurityException</b></li> <li>■ ■ CRLException()</li> </ul>	<ul style="list-style-type: none"> <li>■ ■ CRLException(String)</li> </ul>
<ul style="list-style-type: none"> <li>■ ■ <b>abstract class X509Certificate extends Certificate implements X509Extension</b></li> <li>■ ■ protected X509Certificate()</li> <li>■ ■ abstract void checkValidity() throws CertificateExpiredException, CertificateNotYetValidException</li> <li>■ ■ abstract void checkValidity(java.util.Date) throws CertificateExpiredException, CertificateNotYetValidException</li> <li>■ ■ abstract int getBasicConstraints()</li> <li>■ ■ java.util.List getExtendedKeyUsage() throws CertificateParsingException</li> <li>■ ■ java.util.Collection getIssuerAlternativeNames() throws CertificateParsingException</li> <li>■ ■ abstract java.security.Principal getIssuerDN()</li> <li>■ ■ abstract boolean[] getIssuerUniqueID()</li> <li>■ ■ javax.security.auth.x500.X500Principal getIssuerX500Principal()</li> <li>■ ■ abstract boolean[] getKeyUsage()</li> <li>■ ■ abstract java.util.Date getNotAfter()</li> <li>■ ■ abstract java.util.Date getNotBefore()</li> </ul>	<ul style="list-style-type: none"> <li>■ ■ abstract java.math.BigInteger getSerialNumber()</li> <li>■ ■ abstract String getSigAlgName()</li> <li>■ ■ abstract String getSigAlgOID()</li> <li>■ ■ abstract byte[] getSigAlgParams()</li> <li>■ ■ abstract byte[] getSignature()</li> <li>■ ■ java.util.Collection getSubjectAlternativeNames() throws CertificateParsingException</li> <li>■ ■ abstract java.security.Principal getSubjectDN()</li> <li>■ ■ abstract boolean[] getSubjectUniqueID()</li> <li>■ ■ javax.security.auth.x500.X500Principal getSubjectX500Principal()</li> <li>■ ■ abstract byte[] getTBSCertificate() throws CertificateEncodingException</li> <li>■ ■ abstract int getVersion()</li> </ul>
<ul style="list-style-type: none"> <li>■ ■ <b>abstract class X509CRL extends CRL implements X509Extension</b></li> </ul>	

- ■ protected X509CRL()
  - ■ abstract byte[] getEncoded() throws CRLException
  - ■ abstract java.security.Principal getIssuerDN()
  - ■ javax.security.auth.x500.X500Principal getIssuerX500Principal()
  - ■ abstract java.util.Date getNextUpdate()
  - ■ abstract X509CRLEntry getRevokedCertificate(java.math.BigInteger)
  - ■ abstract java.util.Set getRevokedCertificates()
  - ■ abstract String getSigAlgName()
  - ■ abstract String getSigAlgOID()
  - ■ abstract byte[] getSigAlgParams()
  - ■ abstract byte[] getSignature()
  - ■ abstract byte[] getTBSCertList() throws CRLException
  - ■ abstract java.util.Date getThisUpdate()
  - ■ abstract int getVersion()
  - ■ abstract void verify(java.security.PublicKey) throws java.security.InvalidKeyException, java.security.NoSuchAlgorithmException, java.security.NoSuchProviderException, java.security.SignatureException, CRLException
  - ■ abstract void verify(java.security.PublicKey, String) throws java.security.InvalidKeyException, java.security.NoSuchAlgorithmException, java.security.NoSuchProviderException, java.security.SignatureException, CRLException
- 
- ■ abstract class X509CRLEntry implements X509Extension
  - ■ X509CRLEntry()
  - ■ abstract byte[] getEncoded() throws CRLException
  - ■ abstract java.util.Date getRevocationDate()
  - ■ abstract java.math.BigInteger getSerialNumber()
  - ■ abstract boolean hasExtensions()
  - ■ abstract String toString()
- 
- ■ interface X509Extension
  - ■ abstract java.util.Set getCriticalExtensionOIDs()
  - ■ abstract byte[] getExtensionValue(String)
  - ■ abstract java.util.Set getNonCriticalExtensionOIDs()
  - ■ abstract boolean hasUnsupportedCriticalExtension()

### 999.3.10 java.security.interfaces

- ■ package java.security.interfaces
- ■ interface DSAKey
- ■ abstract DSAParams getParams()
- ■ interface DSAKeyPairGenerator
- ■ abstract void initialize(int,boolean,java.security.SecureRandom)
- ■ abstract void initialize(DSAParams,java.security.SecureRandom)
- ■ interface DSAParams
- ■ abstract java.math.BigInteger getG()
- ■ abstract java.math.BigInteger getP()
- ■ interface DSAPrivateKey extends java.security.PrivateKey , DSAKey
- ■ abstract java.math.BigInteger getX()
- ■ final static long serialVersionUID
- ■ interface DSAPublicKey extends java.security.PublicKey , DSAKey
- ■ abstract java.math.BigInteger getY()
- ■ final static long serialVersionUID
- ■ interface RSAKey
- ■ abstract java.math.BigInteger getModulus()
- ■ interface RSAPrivateCrtKey extends RSAPrivateKey
- ■ abstract java.math.BigInteger getCrtCoefficient()
- ■ abstract java.math.BigInteger getPrimeExponentP()
- ■ abstract java.math.BigInteger getPrimeExponentQ()
- ■ abstract java.math.BigInteger getPrimeP()
- ■ abstract java.math.BigInteger getPublicExponent()
- ■ interface RSAPrivateKey extends java.security.PrivateKey , RSAKey
- ■ abstract java.math.BigInteger getPrivateExponent()
- ■ interface RSAPublicKey extends java.security.PublicKey , RSAKey
- ■ abstract java.math.BigInteger getPublicExponent()

### 999.3.11 java.security.spec

- ■ package java.security.spec
- ■ interface AlgorithmParameterSpec
- ■ class DSAParameterSpec implements java.security.interfaces.DSAParams , AlgorithmParameterSpec
- ■ DSAParameterSpec(java.math.BigInteger,java.math.BigInteger,java.math.BigInteger)
- ■ java.math.BigInteger getG()
- ■ java.math.BigInteger getP()
- ■ java.math.BigInteger getQ()
- ■ class DSAPrivateKeySpec implements KeySpec
- ■ DSAPrivateKeySpec(java.math.BigInteger,java.math.BigInteger,java.math.BigInteger)
- ■ java.math.BigInteger getG()
- ■ java.math.BigInteger getP()
- ■ class DSAPublicKeySpec implements KeySpec
- ■ DSAPublicKeySpec(java.math.BigInteger,java.math.BigInteger,java.math.BigInteger)
- ■ java.math.BigInteger getG()
- ■ java.math.BigInteger getP()
- ■ abstract class EncodedKeySpec implements KeySpec

<ul style="list-style-type: none"> <li>■ ■ EncodedKeySpec(byte[])</li> <li>■ ■ byte[] getEncoded()</li> </ul>	<ul style="list-style-type: none"> <li>■ ■ abstract String getFormat()</li> </ul>
<ul style="list-style-type: none"> <li>■ ■ <b>class InvalidKeySpecException extends java.security.GeneralSecurityException</b></li> </ul>	
<ul style="list-style-type: none"> <li>■ ■ InvalidKeySpecException()</li> </ul>	<ul style="list-style-type: none"> <li>■ ■ InvalidKeySpecException(String)</li> </ul>
<ul style="list-style-type: none"> <li>■ ■ <b>class InvalidParameterSpecException extends java.security.GeneralSecurityException</b></li> </ul>	
<ul style="list-style-type: none"> <li>■ ■ InvalidParameterSpecException()</li> </ul>	<ul style="list-style-type: none"> <li>■ ■ InvalidParameterSpecException(String)</li> </ul>
<ul style="list-style-type: none"> <li>■ ■ <b>interface KeySpec</b></li> </ul>	
<ul style="list-style-type: none"> <li>■ ■ <b>class PKCS8EncodedKeySpec extends EncodedKeySpec</b></li> </ul>	
<ul style="list-style-type: none"> <li>■ ■ PKCS8EncodedKeySpec(byte[])</li> </ul>	<ul style="list-style-type: none"> <li>■ ■ final String getFormat()</li> </ul>
<ul style="list-style-type: none"> <li>■ ■ <b>class PSSParameterSpec implements AlgorithmParameterSpec</b></li> </ul>	
<ul style="list-style-type: none"> <li>■ ■ PSSParameterSpec(int)</li> </ul>	<ul style="list-style-type: none"> <li>■ ■ int getSaltLength()</li> </ul>
<ul style="list-style-type: none"> <li>■ ■ <b>class RSAKeyGenParameterSpec implements AlgorithmParameterSpec</b></li> </ul>	
<ul style="list-style-type: none"> <li>■ ■ RSAKeyGenParameterSpec(int,java.math.BigInteger)</li> </ul>	<ul style="list-style-type: none"> <li>■ ■ int getKeySize()</li> </ul>
<ul style="list-style-type: none"> <li>■ ■ final static java.math.BigInteger Fo</li> </ul>	<ul style="list-style-type: none"> <li>■ ■ java.math.BigInteger getPublicExponent()</li> </ul>
<ul style="list-style-type: none"> <li>■ ■ final static java.math.BigInteger F4</li> </ul>	
<ul style="list-style-type: none"> <li>■ ■ <b>class RSAPrivateCrtKeySpec extends RSAPrivateKeySpec</b></li> </ul>	
<ul style="list-style-type: none"> <li>■ ■ RSAPrivateCrtKeySpec(java.math.BigInteger,java.math.BigInteger,java.math.BigInteger,java.math.BigInteger,java.math.BigInteger,java.math.BigInteger)</li> </ul>	<ul style="list-style-type: none"> <li>■ ■ java.math.BigInteger getPrimeP()</li> <li>■ ■ java.math.BigInteger getPrimeQ()</li> <li>■ ■ java.math.BigInteger getPublicExponent()</li> </ul>
<ul style="list-style-type: none"> <li>■ ■ java.math.BigInteger getCrtCoefficient()</li> </ul>	
<ul style="list-style-type: none"> <li>■ ■ java.math.BigInteger getPrimeExponentP()</li> </ul>	
<ul style="list-style-type: none"> <li>■ ■ java.math.BigInteger getPrimeExponentQ()</li> </ul>	
<ul style="list-style-type: none"> <li>■ ■ <b>class RSAPrivateKeySpec implements KeySpec</b></li> </ul>	
<ul style="list-style-type: none"> <li>■ ■ RSAPrivateKeySpec(java.math.BigInteger,java.math.BigInteger)</li> </ul>	<ul style="list-style-type: none"> <li>■ ■ java.math.BigInteger getPrivateExponent()</li> </ul>
<ul style="list-style-type: none"> <li>■ ■ java.math.BigInteger getModulus()</li> </ul>	
<ul style="list-style-type: none"> <li>■ ■ <b>class RSAPublicKeySpec implements KeySpec</b></li> </ul>	
<ul style="list-style-type: none"> <li>■ ■ RSAPublicKeySpec(java.math.BigInteger,java.math.BigInteger)</li> </ul>	<ul style="list-style-type: none"> <li>■ ■ java.math.BigInteger getPublicExponent()</li> </ul>
<ul style="list-style-type: none"> <li>■ ■ java.math.BigInteger getModulus()</li> </ul>	
<ul style="list-style-type: none"> <li>■ ■ <b>class X509EncodedKeySpec extends EncodedKeySpec</b></li> </ul>	
<ul style="list-style-type: none"> <li>■ ■ X509EncodedKeySpec(byte[])</li> </ul>	<ul style="list-style-type: none"> <li>■ ■ final String getFormat()</li> </ul>

## 999.3.12

## java.text

<ul style="list-style-type: none"> <li>■ ■ <b>package java.text</b></li> </ul>	
<ul style="list-style-type: none"> <li>■ ■ <b>class Annotation</b></li> </ul>	
<ul style="list-style-type: none"> <li>■ ■ Annotation(Object)</li> </ul>	<ul style="list-style-type: none"> <li>■ ■ Object getValue()</li> </ul>
<ul style="list-style-type: none"> <li>■ ■ <b>interface AttributedCharacterIterator extends CharacterIterator</b></li> </ul>	
<ul style="list-style-type: none"> <li>■ ■ abstract java.util.Set getAllAttributeKeys()</li> </ul>	<ul style="list-style-type: none"> <li>■ ■ abstract int getRunLimit(java.util.Set)</li> </ul>
<ul style="list-style-type: none"> <li>■ ■ abstract Object getAttribute(AttributedCharacterIterator.Attribute)</li> </ul>	<ul style="list-style-type: none"> <li>■ ■ abstract int getRunStart()</li> </ul>
<ul style="list-style-type: none"> <li>■ ■ abstract java.util.Map getAttributes()</li> </ul>	<ul style="list-style-type: none"> <li>■ ■ abstract int getRunStart(AttributedCharacterIterator.Attribute)</li> </ul>
<ul style="list-style-type: none"> <li>■ ■ abstract int getRunLimit()</li> </ul>	<ul style="list-style-type: none"> <li>■ ■ abstract int getRunStart(java.util.Set)</li> </ul>
<ul style="list-style-type: none"> <li>■ ■ abstract int getRunLimit(AttributedCharacterIterator.Attribute)</li> </ul>	
<ul style="list-style-type: none"> <li>■ ■ <b>class AttributedCharacterIterator.Attribute implements java.io.Serializable</b></li> </ul>	
<ul style="list-style-type: none"> <li>■ ■ protected AttributedCharacterIterator.Attribute(String)</li> </ul>	<ul style="list-style-type: none"> <li>■ ■ final static AttributedCharacterIterator.Attribute INPUT_METHOD_SEGMENT</li> </ul>
<ul style="list-style-type: none"> <li>■ ■ final boolean equals(Object)</li> </ul>	<ul style="list-style-type: none"> <li>■ ■ final static AttributedCharacterIterator.Attribute LANGUAGE</li> </ul>
<ul style="list-style-type: none"> <li>■ ■ protected String getName()</li> </ul>	<ul style="list-style-type: none"> <li>■ ■ final static AttributedCharacterIterator.Attribute READING</li> </ul>
<ul style="list-style-type: none"> <li>■ ■ final int hashCode()</li> </ul>	<ul style="list-style-type: none"> <li>■ ■ protected Object readResolve() throws java.io.InvalidObjectException</li> </ul>
<ul style="list-style-type: none"> <li>■ ■ <b>class AttributedString</b></li> </ul>	
<ul style="list-style-type: none"> <li>■ ■ AttributedString(String)</li> </ul>	<ul style="list-style-type: none"> <li>■ ■ void addAttribute(AttributedCharacterIterator.Attribute, Object, int, int)</li> </ul>
<ul style="list-style-type: none"> <li>■ ■ AttributedString(String,java.util.Map)</li> </ul>	<ul style="list-style-type: none"> <li>■ ■ void addAttributes(java.util.Map, int, int)</li> </ul>
<ul style="list-style-type: none"> <li>■ ■ AttributedString(AttributedCharacterIterator)</li> </ul>	<ul style="list-style-type: none"> <li>■ ■ AttributedCharacterIterator getIterator()</li> </ul>
<ul style="list-style-type: none"> <li>■ ■ AttributedString(AttributedCharacterIterator, int, int)</li> </ul>	<ul style="list-style-type: none"> <li>■ ■ AttributedCharacterIterator getIterator(AttributedCharacterIterator.Attribute[])</li> </ul>
<ul style="list-style-type: none"> <li>■ ■ AttributedString(AttributedCharacterIterator, int, int, AttributedCharacterIterator.Attribute[])</li> </ul>	<ul style="list-style-type: none"> <li>■ ■ AttributedCharacterIterator getIterator(AttributedCharacterIterator.Attribute[], int, int)</li> </ul>
<ul style="list-style-type: none"> <li>■ ■ void addAttribute(AttributedCharacterIterator.Attribute, Object)</li> </ul>	
<ul style="list-style-type: none"> <li>■ ■ <b>abstract class BreakIterator implements Cloneable</b></li> </ul>	
<ul style="list-style-type: none"> <li>■ ■ protected BreakIterator()</li> </ul>	<ul style="list-style-type: none"> <li>■ ■ static BreakIterator getSentenceInstance(java.util.Locale)</li> </ul>
<ul style="list-style-type: none"> <li>■ ■ Object clone()</li> </ul>	<ul style="list-style-type: none"> <li>■ ■ abstract CharacterIterator getText()</li> </ul>
<ul style="list-style-type: none"> <li>■ ■ abstract int current()</li> </ul>	<ul style="list-style-type: none"> <li>■ ■ static BreakIterator getWordInstance()</li> </ul>
<ul style="list-style-type: none"> <li>■ ■ final static int DONE</li> </ul>	<ul style="list-style-type: none"> <li>■ ■ static BreakIterator getWordInstance(java.util.Locale)</li> </ul>
<ul style="list-style-type: none"> <li>■ ■ abstract int first()</li> </ul>	<ul style="list-style-type: none"> <li>■ ■ boolean isBoundary(int)</li> </ul>
<ul style="list-style-type: none"> <li>■ ■ abstract int following(int)</li> </ul>	<ul style="list-style-type: none"> <li>■ ■ abstract int last()</li> </ul>
<ul style="list-style-type: none"> <li>■ ■ static java.util.Locale[] getAvailableLocales()</li> </ul>	<ul style="list-style-type: none"> <li>■ ■ abstract int next()</li> </ul>
<ul style="list-style-type: none"> <li>■ ■ static BreakIterator getCharacterInstance()</li> </ul>	<ul style="list-style-type: none"> <li>■ ■ abstract int next(int)</li> </ul>
<ul style="list-style-type: none"> <li>■ ■ static BreakIterator getCharacterInstance(java.util.Locale)</li> </ul>	<ul style="list-style-type: none"> <li>■ ■ int preceding(int)</li> </ul>
<ul style="list-style-type: none"> <li>■ ■ static BreakIterator getLineInstance()</li> </ul>	<ul style="list-style-type: none"> <li>■ ■ abstract int previous()</li> </ul>
<ul style="list-style-type: none"> <li>■ ■ static BreakIterator getLineInstance(java.util.Locale)</li> </ul>	<ul style="list-style-type: none"> <li>■ ■ void setText(String)</li> </ul>
<ul style="list-style-type: none"> <li>■ ■ static BreakIterator getSentenceInstance()</li> </ul>	<ul style="list-style-type: none"> <li>■ ■ abstract void setText(CharacterIterator)</li> </ul>

---

<b>■ ■ interface CharacterIterator extends Cloneable</b>	
■ ■ abstract Object clone()	■ ■ abstract int getIndex()
■ ■ abstract char current()	■ ■ abstract char last()
■ ■ final static char DONE	■ ■ abstract char next()
■ ■ abstract char first()	■ ■ abstract char previous()
■ ■ abstract int getBeginIndex()	■ ■ abstract char setIndex(int)
■ ■ abstract int getEndIndex()	
<hr/>	
<b>■ ■ class ChoiceFormat extends NumberFormat</b>	
■ ■ ChoiceFormat(double[],String[])	■ ■ final static double nextDouble(double)
■ ■ ChoiceFormat(String)	■ ■ static double nextDouble(double,boolean)
■ ■ void applyPattern(String)	■ ■ Number parse(String,ParsePosition)
■ ■ StringBuffer format(double,StringBuffer,FieldPosition)	■ ■ final static double previousDouble(double)
■ ■ StringBuffer format(long,StringBuffer,FieldPosition)	■ ■ void setChoices(double[],String[])
■ ■ Object[] getFormats()	■ ■ String toPattern()
■ ■ double[] getLimits()	
<hr/>	
<b>■ ■ final class CollationElementIterator</b>	
■ ■ int getMaxExpansion(int)	■ ■ void reset()
■ ■ int getOffset()	■ ■ final static short secondaryOrder(int)
■ ■ int next()	■ ■ void setOffset(int)
■ ■ final static int NULLORDER	■ ■ void setText(String)
■ ■ int previous()	■ ■ void setText(CharacterIterator)
■ ■ final static int primaryOrder(int)	■ ■ final static short tertiaryOrder(int)
<hr/>	
<b>■ ■ final class CollationKey implements Comparable</b>	
■ ■ int compareTo(Object)	■ ■ String getSourceString()
■ ■ int compareTo(CollationKey)	■ ■ byte[] toByteArray()
<hr/>	
<b>■ ■ abstract class Collator implements Cloneable , java.util.Comparator</b>	
■ ■ protected Collator()	■ ■ static Collator getInstance(java.util.Locale)
■ ■ final static int CANONICAL_DECOMPOSITION	■ ■ int getStrength()
■ ■ Object clone()	■ ■ abstract int hashCode()
■ ■ int compare(Object, Object)	■ ■ final static int IDENTICAL
■ ■ abstract int compare(String, String)	■ ■ final static int NO_DECOMPOSITION
■ ■ boolean equals(String, String)	■ ■ final static int PRIMARY
■ ■ final static int FULL_DECOMPOSITION	■ ■ final static int SECONDARY
■ ■ static java.util.Locale[] getAvailableLocales()	■ ■ void setDecomposition(int)
■ ■ abstract CollationKey getCollationKey(String)	■ ■ void setStrength(int)
■ ■ int getDecomposition()	■ ■ final static int TERTIARY
■ ■ static Collator getInstance()	
<hr/>	
<b>■ ■ abstract class DateFormat extends Format</b>	
■ ■ protected DateFormat()	■ ■ java.util.TimeZone getTimeZone()
■ ■ final static int AM_PM_FIELD	■ ■ final static int HOURo_FIELD
■ ■ protected java.util.Calendar calendar	■ ■ final static int HOUR1_FIELD
■ ■ final static int DATE_FIELD	■ ■ final static int HOUR_OF_DAYo_FIELD
■ ■ final static int DAY_OF_WEEK_FIELD	■ ■ final static int HOUR_OF_DAY1_FIELD
■ ■ final static int DAY_OF_WEEK_IN_MONTH_FIELD	■ ■ boolean isLenient()
■ ■ final static int DAY_OF_YEAR_FIELD	■ ■ final static int LONG
■ ■ final static int DEFAULT	■ ■ final static int MEDIUM
■ ■ final static int ERA_FIELD	■ ■ final static int MILLISECOND_FIELD
■ ■ final StringBuffer format(Object,StringBuffer,FieldPosition)	■ ■ final static int MINUTE_FIELD
■ ■ final String format(java.util.Date)	■ ■ final static int MONTH_FIELD
■ ■ abstract StringBuffer format(java.util.Date,StringBuffer,FieldPosition)	■ ■ protected NumberFormat numberFormat
■ ■ final static int FULL	■ ■ java.util.Date parse(String) throws ParseException
■ ■ static java.util.Locale[] getAvailableLocales()	■ ■ abstract java.util.Date parse(String,ParsePosition)
■ ■ java.util.Calendar getCalendar()	■ ■ Object parseObject(String,ParsePosition)
■ ■ final static DateFormat getDateInstance()	■ ■ final static int SECONd_FIELD
■ ■ final static DateFormat getDateInstance(int)	■ ■ void setCalendar(java.util.Calendar)
■ ■ final static DateFormat getDateInstance(int,java.util.Locale)	■ ■ void setLenient(boolean)
■ ■ final static DateFormat getDateTimelInstance()	■ ■ void setNumberFormat(NumberFormat)
■ ■ final static DateFormat getDateTimelInstance(int,int)	■ ■ void setTimeZone(java.util.TimeZone)
■ ■ final static DateFormat getDateTimelInstance(int,int,java.util.Locale)	■ ■ final static int SHORT
■ ■ final static DateFormat getlInstance()	■ ■ final static int TIMEZONE_FIELD
■ ■ NumberFormat getNumberFormat()	■ ■ final static int WEEK_OF_MONTH_FIELD
■ ■ final static DateFormat getTimelInstance()	■ ■ final static int WEEK_OF_YEAR_FIELD
■ ■ final static DateFormat getTimelInstance(int)	■ ■ final static int YEAR_FIELD
■ ■ final static DateFormat getTimelInstance(int,java.util.Locale)	
<hr/>	
<b>■ ■ class DateFormat.Field extends Format.Field</b>	

- ■ protected DateFormat.Field(String,int)
  - ■ final static DateFormat.Field AM\_PM
  - ■ final static DateFormat.Field DAY\_OF\_MONTH
  - ■ final static DateFormat.Field DAY\_OF\_WEEK
  - ■ final static DateFormat.Field DAY\_OF\_WEEK\_IN\_MONTH
  - ■ final static DateFormat.Field DAY\_OF\_YEAR
  - ■ final static DateFormat.Field ERA
  - ■ int getCalendarField()
  - ■ final static DateFormat.Field HOURo
  - ■ final static DateFormat.Field HOUR1
  - ■ final static DateFormat.Field HOUR\_OF\_DAYo
  - ■ final static DateFormat.Field HOUR\_OF\_DAY1
  - ■ final static DateFormat.Field HOUR\_OF\_YEAR
  - ■ final static DateFormat.Field YEAR
  - ■ final static DateFormat.Field HOUR\_OF\_DAY1
  - ■ final static DateFormat.Field MILLISSECOND
  - ■ final static DateFormat.Field MINUTE
  - ■ final static DateFormat.Field MONTH
  - ■ static DateFormat.Field ofCalendarField(int)
  - ■ final static DateFormat.Field SECOND
  - ■ final static DateFormat.Field TIME\_ZONE
  - ■ final static DateFormat.Field WEEK\_OF\_MONTH
  - ■ final static DateFormat.Field WEEK\_OF\_YEAR
  - ■ final static DateFormat.Field YEAR
- 
- ■ **class DateFormatSymbols implements java.io.Serializable , Cloneable**
  - ■ DateFormatSymbols()
  - ■ DateFormatSymbols(java.util.Locale)
  - ■ Object clone()
  - ■ String[] getAmPmStrings()
  - ■ String[] getEras()
  - ■ String getLocalPatternChars()
  - ■ String[] getMonths()
  - ■ String[] getShortMonths()
  - ■ String[] getShortWeekdays()
  - ■ String[] getWeekdays()
  - ■ String[] getZoneStrings()
  - ■ void setAmPmStrings(String[])
  - ■ void setEras(String[])
  - ■ void setLocalPatternChars(String)
  - ■ void setMonths(String[])
  - ■ void setShortMonths(String[])
  - ■ void setShortWeekdays(String[])
  - ■ void setWeekdays(String[])
  - ■ void setZoneStrings(String[][])
- 
- ■ **class DecimalFormat extends NumberFormat**
  - ■ DecimalFormat()
  - ■ DecimalFormat(String)
  - ■ DecimalFormat(String,DecimalFormatSymbols)
  - ■ void applyLocalizedPattern(String)
  - ■ void applyPattern(String)
  - ■ StringBuffer format(double,StringBuffer,FieldPosition)
  - ■ StringBuffer format(long,StringBuffer,FieldPosition)
  - ■ DecimalFormatSymbols getDecimalFormatSymbols()
  - ■ int getGroupingSize()
  - ■ int getMultiplier()
  - ■ String getNegativePrefix()
  - ■ String getNegativeSuffix()
  - ■ String getPositivePrefix()
  - ■ String getPositiveSuffix()
  - ■ boolean isDecimalSeparatorAlwaysShown()
  - ■ Number parse(String,ParsePosition)
  - ■ void setDecimalFormatSymbols(DecimalFormatSymbols)
  - ■ void setDecimalSeparatorAlwaysShown(boolean)
  - ■ void setGroupingSize(int)
  - ■ void setMultiplier(int)
  - ■ void setNegativePrefix(String)
  - ■ void setNegativeSuffix(String)
  - ■ void setPositivePrefix(String)
  - ■ void setPositiveSuffix(String)
  - ■ String toLocalizedPattern()
  - ■ String toPattern()
- 
- ■ **final class DecimalFormatSymbols implements java.io.Serializable , Cloneable**
  - ■ DecimalFormatSymbols()
  - ■ DecimalFormatSymbols(java.util.Locale)
  - ■ Object clone()
  - ■ java.util.Currency getCurrency()
  - ■ String getCurrencySymbol()
  - ■ char getDecimalSeparator()
  - ■ char getDigit()
  - ■ char getGroupingSeparator()
  - ■ String getInfinity()
  - ■ String getInternationalCurrencySymbol()
  - ■ char getMinusSign()
  - ■ char getMonetaryDecimalSeparator()
  - ■ String getNaN()
  - ■ char getPatternSeparator()
  - ■ char getPercent()
  - ■ char getPerMill()
  - ■ char getZeroDigit()
  - ■ void setCurrency(java.util.Currency)
  - ■ void setCurrencySymbol(String)
  - ■ void setDecimalSeparator(char)
  - ■ void setDigit(char)
  - ■ void setGroupingSeparator(char)
  - ■ void setInfinity(String)
  - ■ void setInternationalCurrencySymbol(String)
  - ■ void setMinusSign(char)
  - ■ void setMonetaryDecimalSeparator(char)
  - ■ void setNaN(String)
  - ■ void setPatternSeparator(char)
  - ■ void setPercent(char)
  - ■ void setPerMill(char)
  - ■ void setZeroDigit(char)
- 
- ■ **class FieldPosition**
  - ■ FieldPosition(int)
  - ■ FieldPosition(Format.Field)
  - ■ FieldPosition(Format.Field,int)
  - ■ int getBeginIndex()
  - ■ int getEndIndex()
  - ■ int getField()
  - ■ Format.Field getFieldAttribute()
  - ■ void setBeginIndex(int)
  - ■ void setEndIndex(int)
- 
- ■ **abstract class Format implements java.io.Serializable , Cloneable**
  - ■ Format()
  - ■ Object clone()
  - ■ final String format(Object)
  - ■ abstract StringBuffer format(Object,StringBuffer,FieldPosition)
  - ■ AttributedCharacterIterator formatToCharacterIterator(Object)
  - ■ Object parseObject(String) throws ParseException
  - ■ abstract Object parseObject(String,ParsePosition)
- 
- ■ **class Format.Field extends AttributedCharacterIterator.Attribute**
  - ■ protected Format.Field(String)
- 
- ■ **class MessageFormat extends Format**

<ul style="list-style-type: none"> <li>■ ■ MessageFormat(String)</li> <li>■ ■ MessageFormat(String,java.util.Locale)</li> <li>■ ■ void applyPattern(String)</li> <li>■ ■ final StringBuffer format(Object[],StringBuffer,FieldPosition)</li> <li>■ ■ final StringBuffer format(Object,StringBuffer,FieldPosition)</li> <li>■ ■ static String format(String,Object[])</li> <li>■ ■ Format[] getFormats()</li> <li>■ ■ Format[] getFormatsByArgumentIndex()</li> <li>■ ■ java.util.Locale getLocale()</li> </ul>	<ul style="list-style-type: none"> <li>■ ■ Object[] parse(String) throws ParseException</li> <li>■ ■ Object[] parse(String,ParsePosition)</li> <li>■ ■ Object parseObject(String,ParsePosition)</li> <li>■ ■ void setFormat(int,Format)</li> <li>■ ■ void setFormatByArgumentIndex(int,Format)</li> <li>■ ■ void setFormats(Format[])</li> <li>■ ■ void setFormatsByArgumentIndex(Format[])</li> <li>■ ■ void setLocale(java.util.Locale)</li> <li>■ ■ String toPattern()</li> </ul>
<hr/>	
<ul style="list-style-type: none"> <li>■ ■ <b>class MessageFormat.Field extends Format.Field</b></li> <li>■ ■ protected MessageFormat.Field(String)</li> </ul>	<ul style="list-style-type: none"> <li>■ ■ final static MessageFormat.Field ARGUMENT</li> </ul>
<hr/>	
<ul style="list-style-type: none"> <li>■ ■ <b>abstract class NumberFormat extends Format</b></li> <li>■ ■ NumberFormat()</li> <li>■ ■ final String format(double)</li> <li>■ ■ abstract StringBuffer format(double,StringBuffer,FieldPosition)</li> <li>■ ■ final String format(long)</li> <li>■ ■ abstract StringBuffer format(long,StringBuffer,FieldPosition)</li> <li>■ ■ final StringBuffer format(Object,StringBuffer,FieldPosition)</li> <li>■ ■ final static int FRACTION_FIELD</li> <li>■ ■ static java.util.Locale[] getAvailableLocales()</li> <li>■ ■ java.util.Currency getCurrency()</li> <li>■ ■ final static NumberFormat getCurrencyInstance()</li> <li>■ ■ static NumberFormat getCurrencyInstance(java.util.Locale)</li> <li>■ ■ final static NumberFormat getInstance()</li> <li>■ ■ static NumberFormat getInstance(java.util.Locale)</li> <li>■ ■ final static NumberFormat getIntegerInstance()</li> <li>■ ■ static NumberFormat getIntegerInstance(java.util.Locale)</li> <li>■ ■ int getMaximumFractionDigits()</li> <li>■ ■ int getMaximumIntegerDigits()</li> <li>■ ■ int getMinimumFractionDigits()</li> </ul>	<ul style="list-style-type: none"> <li>■ ■ int getMinimumIntegerDigits()</li> <li>■ ■ final static NumberFormat getNumberInstance()</li> <li>■ ■ static NumberFormat getNumberInstance(java.util.Locale)</li> <li>■ ■ final static NumberFormat getPercentInstance()</li> <li>■ ■ static NumberFormat getPercentInstance(java.util.Locale)</li> <li>■ ■ final static int INTEGER_FIELD</li> <li>■ ■ boolean isGroupingUsed()</li> <li>■ ■ boolean isParseIntegerOnly()</li> <li>■ ■ Number parse(String) throws ParseException</li> <li>■ ■ abstract Number parse(String,ParsePosition)</li> <li>■ ■ final Object parseObject(String,ParsePosition)</li> <li>■ ■ void setCurrency(java.util.Currency)</li> <li>■ ■ void setGroupingUsed(boolean)</li> <li>■ ■ void setMaximumFractionDigits(int)</li> <li>■ ■ void setMaximumIntegerDigits(int)</li> <li>■ ■ void setMinimumFractionDigits(int)</li> <li>■ ■ void setMinimumIntegerDigits(int)</li> <li>■ ■ void setParseIntegerOnly(boolean)</li> </ul>
<hr/>	
<ul style="list-style-type: none"> <li>■ ■ <b>class NumberFormat.Field extends Format.Field</b></li> <li>■ ■ protected NumberFormat.Field(String)</li> <li>■ ■ final static NumberFormat.Field CURRENCY</li> <li>■ ■ final static NumberFormat.Field DECIMAL_SEPARATOR</li> <li>■ ■ final static NumberFormat.Field EXPONENT</li> <li>■ ■ final static NumberFormat.Field EXPONENT_SIGN</li> <li>■ ■ final static NumberFormat.Field EXPONENT_SYMBOL</li> </ul>	<ul style="list-style-type: none"> <li>■ ■ final static NumberFormat.Field FRACTION</li> <li>■ ■ final static NumberFormat.Field GROUPING_SEPARATOR</li> <li>■ ■ final static NumberFormat.Field INTEGER</li> <li>■ ■ final static NumberFormat.Field PERCENT</li> <li>■ ■ final static NumberFormat.Field PERMILLE</li> <li>■ ■ final static NumberFormat.Field SIGN</li> </ul>
<hr/>	
<ul style="list-style-type: none"> <li>■ ■ <b>class ParseException extends Exception</b></li> <li>■ ■ ParseException(String,int)</li> </ul>	<ul style="list-style-type: none"> <li>■ ■ int getErrorOffset()</li> </ul>
<hr/>	
<ul style="list-style-type: none"> <li>■ ■ <b>class ParsePosition</b></li> <li>■ ■ ParsePosition(int)</li> <li>■ ■ int getErrorIndex()</li> <li>■ ■ int getIndex()</li> </ul>	<ul style="list-style-type: none"> <li>■ ■ void setErrorIndex(int)</li> <li>■ ■ void setIndex(int)</li> </ul>
<hr/>	
<ul style="list-style-type: none"> <li>■ ■ <b>class RuleBasedCollator extends Collator</b></li> <li>■ ■ RuleBasedCollator(String) throws ParseException</li> <li>■ ■ int compare(String,String)</li> <li>■ ■ CollationElementIterator getCollationElementIterator(String)</li> <li>■ ■ CollationElementIterator getCollationElementIterator(CharacterIterator)</li> </ul>	<ul style="list-style-type: none"> <li>■ ■ CollationKey getCollationKey(String)</li> <li>■ ■ String getRules()</li> <li>■ ■ int hashCode()</li> </ul>
<hr/>	
<ul style="list-style-type: none"> <li>■ ■ <b>class SimpleDateFormat extends DateFormat</b></li> <li>■ ■ SimpleDateFormat()</li> <li>■ ■ SimpleDateFormat(String)</li> <li>■ ■ SimpleDateFormat(String,DateFormatSymbols)</li> <li>■ ■ SimpleDateFormat(String,java.util.Locale)</li> <li>■ ■ void applyLocalizedPattern(String)</li> <li>■ ■ void applyPattern(String)</li> <li>■ ■ StringBuffer format(java.util.Date,StringBuffer,FieldPosition)</li> </ul>	<ul style="list-style-type: none"> <li>■ ■ java.util.Date get2DigitYearStart()</li> <li>■ ■ DateFormatSymbols getDateFormatSymbols()</li> <li>■ ■ java.util.Date parse(String,ParsePosition)</li> <li>■ ■ void set2DigitYearStart(java.util.Date)</li> <li>■ ■ void setDateFormatSymbols(DateFormatSymbols)</li> <li>■ ■ String toLocalizedPattern()</li> <li>■ ■ String toPattern()</li> </ul>
<hr/>	
<ul style="list-style-type: none"> <li>■ ■ <b>final class StringCharacterIterator implements CharacterIterator</b></li> <li>■ ■ StringCharacterIterator(String)</li> <li>■ ■ StringCharacterIterator(String,int)</li> <li>■ ■ StringCharacterIterator(String,int,int,int)</li> <li>■ ■ Object clone()</li> <li>■ ■ char current()</li> <li>■ ■ char first()</li> <li>■ ■ int getBeginIndex()</li> </ul>	<ul style="list-style-type: none"> <li>■ ■ int getEndIndex()</li> <li>■ ■ int getIndex()</li> <li>■ ■ char last()</li> <li>■ ■ char next()</li> <li>■ ■ char previous()</li> <li>■ ■ char setIndex(int)</li> <li>■ ■ void setText(String)</li> </ul>

999.3.13

java.util

- ■ package java.util
- ■ abstract class AbstractCollection implements Collection

<ul style="list-style-type: none"> <li>■ ■ protected AbstractCollection()</li> <li>■ ■ boolean add(Object)</li> <li>■ ■ boolean addAll(Collection)</li> <li>■ ■ void clear()</li> <li>■ ■ boolean contains(Object)</li> <li>■ ■ boolean containsAll(Collection)</li> </ul>	<ul style="list-style-type: none"> <li>■ ■ boolean isEmpty()</li> <li>■ ■ boolean remove(Object)</li> <li>■ ■ boolean removeAll(Collection)</li> <li>■ ■ boolean retainAll(Collection)</li> <li>■ ■ Object[] toArray()</li> <li>■ ■ Object[] toArray(Object[])</li> </ul>
<b>■ ■ abstract class AbstractList extends AbstractCollection implements List</b>	
<ul style="list-style-type: none"> <li>■ ■ protected AbstractList()</li> <li>■ ■ void add(int, Object)</li> <li>■ ■ boolean addAll(int, Collection)</li> <li>■ ■ int indexOf(Object)</li> <li>■ ■ Iterator iterator()</li> <li>■ ■ int lastIndexOf(Object)</li> <li>■ ■ ListIterator listIterator()</li> </ul>	<ul style="list-style-type: none"> <li>■ ■ ListIterator listIterator(int)</li> <li>■ ■ protected int modCount</li> <li>■ ■ Object remove(int)</li> <li>■ ■ protected void removeRange(int, int)</li> <li>■ ■ Object set(int, Object)</li> <li>■ ■ List subList(int, int)</li> </ul>
<b>■ ■ abstract class AbstractMap implements Map</b>	
<ul style="list-style-type: none"> <li>■ ■ protected AbstractMap()</li> <li>■ ■ void clear()</li> <li>■ ■ boolean containsKey(Object)</li> <li>■ ■ boolean containsValue(Object)</li> <li>■ ■ Object get(Object)</li> <li>■ ■ boolean isEmpty()</li> </ul>	<ul style="list-style-type: none"> <li>■ ■ Set keySet()</li> <li>■ ■ Object put(Object, Object)</li> <li>■ ■ void putAll(Map)</li> <li>■ ■ Object remove(Object)</li> <li>■ ■ int size()</li> <li>■ ■ Collection values()</li> </ul>
<b>■ ■ abstract class AbstractSequentialList extends AbstractList</b>	
<ul style="list-style-type: none"> <li>■ ■ protected AbstractSequentialList()</li> <li>■ ■ Object get(int)</li> </ul>	<ul style="list-style-type: none"> <li>■ ■ abstract ListIterator listIterator(int)</li> </ul>
<b>■ ■ abstract class AbstractSet extends AbstractCollection implements Set</b>	
<ul style="list-style-type: none"> <li>■ ■ protected AbstractSet()</li> </ul>	
<b>■ ■ class ArrayList extends AbstractList implements java.io.Serializable , Cloneable , List , RandomAccess</b>	
<ul style="list-style-type: none"> <li>■ ■ ArrayList()</li> <li>■ ■ ArrayList(int)</li> <li>■ ■ ArrayList(Collection)</li> <li>■ ■ Object clone()</li> </ul>	<ul style="list-style-type: none"> <li>■ ■ void ensureCapacity(int)</li> <li>■ ■ Object get(int)</li> <li>■ ■ int size()</li> <li>■ ■ void trimToSize()</li> </ul>
<b>■ ■ class Arrays</b>	
<ul style="list-style-type: none"> <li>■ ■ static List asList(Object[])</li> <li>■ ■ static int binarySearch(byte[], byte)</li> <li>■ ■ static int binarySearch(char[], char)</li> <li>■ ■ static int binarySearch(double[], double)</li> <li>■ ■ static int binarySearch(float[], float)</li> <li>■ ■ static int binarySearch(int[], int)</li> <li>■ ■ static int binarySearch(long[], long)</li> <li>■ ■ static int binarySearch(Object[], Object)</li> <li>■ ■ static int binarySearch(Object[], Object, Comparator)</li> <li>■ ■ static int binarySearch(short[], short)</li> <li>■ ■ static boolean equals(byte[], byte[])</li> <li>■ ■ static boolean equals(char[], char[])</li> <li>■ ■ static boolean equals(double[], double[])</li> <li>■ ■ static boolean equals(float[], float[])</li> <li>■ ■ static boolean equals(int[], int[])</li> <li>■ ■ static boolean equals(long[], long[])</li> <li>■ ■ static boolean equals(Object[], Object[])</li> <li>■ ■ static boolean equals(short[], short[])</li> <li>■ ■ static boolean equals(boolean[], boolean[])</li> <li>■ ■ static void fill(byte[], byte)</li> <li>■ ■ static void fill(byte[], int, int, byte)</li> <li>■ ■ static void fill(char[], char)</li> <li>■ ■ static void fill(char[], int, int, char)</li> <li>■ ■ static void fill(double[], double)</li> <li>■ ■ static void fill(double[], int, int, double)</li> <li>■ ■ static void fill(float[], float)</li> <li>■ ■ static void fill(float[], int, int, float)</li> <li>■ ■ static void fill(int[], int)</li> </ul>	<ul style="list-style-type: none"> <li>■ ■ static void fill(int[], int, int, int)</li> <li>■ ■ static void fill(long[], int, int, long)</li> <li>■ ■ static void fill(long[], long)</li> <li>■ ■ static void fill(Object[], int, int, Object)</li> <li>■ ■ static void fill(Object[], Object)</li> <li>■ ■ static void fill(short[], int, int, short)</li> <li>■ ■ static void fill(short[], short)</li> <li>■ ■ static void fill(boolean[], int, int, boolean)</li> <li>■ ■ static void fill(boolean[], boolean)</li> <li>■ ■ static void sort(byte[])</li> <li>■ ■ static void sort(byte[], int, int)</li> <li>■ ■ static void sort(char[])</li> <li>■ ■ static void sort(char[], int, int)</li> <li>■ ■ static void sort(double[])</li> <li>■ ■ static void sort(double[], int, int)</li> <li>■ ■ static void sort(float[])</li> <li>■ ■ static void sort(float[], int, int)</li> <li>■ ■ static void sort(int[])</li> <li>■ ■ static void sort(int[], int, int)</li> <li>■ ■ static void sort(long[])</li> <li>■ ■ static void sort(long[], int, int)</li> <li>■ ■ static void sort(Object[], int, int, Comparator)</li> <li>■ ■ static void sort(Object[], Comparator)</li> <li>■ ■ static void sort(short[])</li> <li>■ ■ static void sort(short[], int, int)</li> </ul>
<b>■ ■ class BitSet implements java.io.Serializable , Cloneable</b>	



<ul style="list-style-type: none"> <li>■ ■ BitSet()</li> <li>■ ■ BitSet(int)</li> <li>■ ■ void and(BitSet)</li> <li>■ ■ void andNot(BitSet)</li> <li>■ ■ int cardinality()</li> <li>■ ■ void clear()</li> <li>■ ■ void clear(int)</li> <li>■ ■ void clear(int,int)</li> <li>■ ■ Object clone()</li> <li>■ ■ void flip(int)</li> <li>■ ■ void flip(int,int)</li> <li>■ ■ boolean get(int)</li> <li>■ ■ BitSet get(int,int)</li> </ul>	<ul style="list-style-type: none"> <li>■ ■ boolean intersects(BitSet)</li> <li>■ ■ boolean isEmpty()</li> <li>■ ■ int length()</li> <li>■ ■ int nextClearBit(int)</li> <li>■ ■ int nextSetBit(int)</li> <li>■ ■ void or(BitSet)</li> <li>■ ■ void set(int)</li> <li>■ ■ void set(int,int)</li> <li>■ ■ void set(int,int,boolean)</li> <li>■ ■ void set(int,boolean)</li> <li>■ ■ int size()</li> <li>■ ■ void xor(BitSet)</li> </ul>
<hr/>	
<ul style="list-style-type: none"> <li>■ ■ <b>abstract class Calendar implements java.io.Serializable , Cloneable</b></li> </ul>	
<ul style="list-style-type: none"> <li>■ ■ protected Calendar()</li> <li>■ ■ protected Calendar(TimeZone,Locale)</li> <li>■ ■ abstract void add(int,int)</li> <li>■ ■ boolean after(Object)</li> <li>■ ■ final static int AM</li> <li>■ ■ final static int AM_PM</li> <li>■ ■ final static int APRIL</li> <li>■ ■ protected boolean areFieldsSet</li> <li>■ ■ final static int AUGUST</li> <li>■ ■ boolean before(Object)</li> <li>■ ■ final void clear()</li> <li>■ ■ final void clear(int)</li> <li>■ ■ Object clone()</li> <li>■ ■ protected void complete()</li> <li>■ ■ abstract protected void computeFields()</li> <li>■ ■ abstract protected void computeTime()</li> <li>■ ■ final static int DATE</li> <li>■ ■ final static int DAY_OF_MONTH</li> <li>■ ■ final static int DAY_OF_WEEK</li> <li>■ ■ final static int DAY_OF_WEEK_IN_MONTH</li> <li>■ ■ final static int DAY_OF_YEAR</li> <li>■ ■ final static int DECEMBER</li> <li>■ ■ final static int DST_OFFSET</li> <li>■ ■ final static int ERA</li> <li>■ ■ final static int FEBRUARY</li> <li>■ ■ final static int FIELD_COUNT</li> <li>■ ■ protected int[] fields</li> <li>■ ■ final static int FRIDAY</li> <li>■ ■ int get(int)</li> <li>■ ■ int getActualMaximum(int)</li> <li>■ ■ int getActualMinimum(int)</li> <li>■ ■ static Locale[] getAvailableLocales()</li> <li>■ ■ int getFirstDayOfWeek()</li> <li>■ ■ abstract int getGreatestMinimum(int)</li> <li>■ ■ static Calendar getInstance()</li> <li>■ ■ static Calendar getInstance(Locale)</li> <li>■ ■ static Calendar getInstance(TimeZone)</li> <li>■ ■ static Calendar getInstance(TimeZone,Locale)</li> <li>■ ■ abstract int getLeastMaximum(int)</li> <li>■ ■ abstract int getMaximum(int)</li> <li>■ ■ int getMinimalDaysInFirstWeek()</li> <li>■ ■ abstract int getMinimum(int)</li> <li>■ ■ final Date getTime()</li> <li>■ ■ long getTimeInMillis()</li> <li>■ ■ TimeZone getTimeZone()</li> </ul>	<ul style="list-style-type: none"> <li>■ ■ final static int HOUR</li> <li>■ ■ final static int HOUR_OF_DAY</li> <li>■ ■ final protected int internalGet(int)</li> <li>■ ■ boolean isLenient()</li> <li>■ ■ final boolean isSet(int)</li> <li>■ ■ protected boolean[] isSet</li> <li>■ ■ protected boolean isTimeSet</li> <li>■ ■ final static int JANUARY</li> <li>■ ■ final static int JULY</li> <li>■ ■ final static int JUNE</li> <li>■ ■ final static int MARCH</li> <li>■ ■ final static int MAY</li> <li>■ ■ final static int MILLISECOND</li> <li>■ ■ final static int MINUTE</li> <li>■ ■ final static int MONDAY</li> <li>■ ■ final static int MONTH</li> <li>■ ■ final static int NOVEMBER</li> <li>■ ■ final static int OCTOBER</li> <li>■ ■ final static int PM</li> <li>■ ■ void roll(int,int)</li> <li>■ ■ abstract void roll(int,boolean)</li> <li>■ ■ final static int SATURDAY</li> <li>■ ■ final static int SECOND</li> <li>■ ■ final static int SEPTEMBER</li> <li>■ ■ void set(int,int)</li> <li>■ ■ final void set(int,int,int)</li> <li>■ ■ final void set(int,int,int,int,int)</li> <li>■ ■ final void set(int,int,int,int,int,int)</li> <li>■ ■ void setFirstDayOfWeek(int)</li> <li>■ ■ void setLenient(boolean)</li> <li>■ ■ void setMinimalDaysInFirstWeek(int)</li> <li>■ ■ final void setTime(Date)</li> <li>■ ■ void setTimeInMillis(long)</li> <li>■ ■ void setTimeZone(TimeZone)</li> <li>■ ■ final static int SUNDAY</li> <li>■ ■ final static int THURSDAY</li> <li>■ ■ protected long time</li> <li>■ ■ final static int TUESDAY</li> <li>■ ■ final static int UNDECIMBER</li> <li>■ ■ final static int WEDNESDAY</li> <li>■ ■ final static int WEEK_OF_MONTH</li> <li>■ ■ final static int WEEK_OF_YEAR</li> <li>■ ■ final static int YEAR</li> <li>■ ■ final static int ZONE_OFFSET</li> </ul>
<hr/>	
<ul style="list-style-type: none"> <li>■ ■ <b>interface Collection</b></li> </ul>	
<ul style="list-style-type: none"> <li>■ ■ abstract boolean add(Object)</li> <li>■ ■ abstract boolean addAll(Collection)</li> <li>■ ■ abstract void clear()</li> <li>■ ■ abstract boolean contains(Object)</li> <li>■ ■ abstract boolean containsAll(Collection)</li> <li>■ ■ abstract boolean equals(Object)</li> <li>■ ■ abstract int hashCode()</li> <li>■ ■ abstract boolean isEmpty()</li> </ul>	<ul style="list-style-type: none"> <li>■ ■ abstract Iterator iterator()</li> <li>■ ■ abstract boolean remove(Object)</li> <li>■ ■ abstract boolean removeAll(Collection)</li> <li>■ ■ abstract boolean retainAll(Collection)</li> <li>■ ■ abstract int size()</li> <li>■ ■ abstract Object[] toArray()</li> <li>■ ■ abstract Object[] toArrayFirst(Object[])</li> </ul>
<hr/>	
<ul style="list-style-type: none"> <li>■ ■ <b>class Collections</b></li> </ul>	

<ul style="list-style-type: none"> <li>■ ■ static int binarySearch(List, Object)</li> <li>■ ■ static int binarySearch(List, Object, Comparator)</li> <li>■ ■ static void copy(List, List)</li> <li>■ ■ final static List EMPTY_LIST</li> <li>■ ■ final static Map EMPTY_MAP</li> <li>■ ■ final static Set EMPTY_SET</li> <li>■ ■ static Enumeration enumeration(Collection)</li> <li>■ ■ static void fill(List, Object)</li> <li>■ ■ static int indexOfSubList(List, List)</li> <li>■ ■ static int lastIndexOfSubList(List, List)</li> <li>■ ■ static Arraylist list(Enumeration)</li> <li>■ ■ static Object max(Collection)</li> <li>■ ■ static Object max(Collection, Comparator)</li> <li>■ ■ static Object min(Collection)</li> <li>■ ■ static Object min(Collection, Comparator)</li> <li>■ ■ static List nCopies(int, Object)</li> <li>■ ■ static boolean replaceAll(List, Object, Object)</li> <li>■ ■ static void reverse(List)</li> <li>■ ■ static Comparator reverseOrder()</li> <li>■ ■ static void rotate(List, int)</li> </ul>	<ul style="list-style-type: none"> <li>■ ■ static void shuffle(List)</li> <li>■ ■ static void shuffle(List, Random)</li> <li>■ ■ static Set singleton(Object)</li> <li>■ ■ static List singletonList(Object)</li> <li>■ ■ static Map singletonMap(Object, Object)</li> <li>■ ■ static void sort(List)</li> <li>■ ■ static void sort(List, Comparator)</li> <li>■ ■ static void swap(List, int, int)</li> <li>■ ■ static Collection synchronizedCollection(Collection)</li> <li>■ ■ static List synchronizedList(List)</li> <li>■ ■ static Map synchronizedMap(Map)</li> <li>■ ■ static Set synchronizedSet(Set)</li> <li>■ ■ static SortedMap synchronizedSortedMap(SortedMap)</li> <li>■ ■ static SortedSet synchronizedSortedSet(SortedSet)</li> <li>■ ■ static Collection unmodifiableCollection(Collection)</li> <li>■ ■ static List unmodifiableList(List)</li> <li>■ ■ static Map unmodifiableMap(Map)</li> <li>■ ■ static Set unmodifiableSet(Set)</li> <li>■ ■ static SortedMap unmodifiableSortedMap(SortedMap)</li> <li>■ ■ static SortedSet unmodifiableSortedSet(SortedSet)</li> </ul>
<ul style="list-style-type: none"> <li>■ ■ <b>interface Comparator</b></li> <li>■ ■ abstract int compare(Object, Object)</li> </ul>	<ul style="list-style-type: none"> <li>■ ■ abstract boolean equals(Object)</li> </ul>
<ul style="list-style-type: none"> <li>■ ■ <b>class ConcurrentModificationException extends RuntimeException</b></li> <li>■ ■ ConcurrentModificationException()</li> <li>■ ■ ConcurrentModificationException(String)</li> </ul>	
<ul style="list-style-type: none"> <li>■ ■ <b>final class Currency implements java.io.Serializable</b></li> <li>■ ■ String getCurrencyCode()</li> <li>■ ■ int getDefaultFractionDigits()</li> <li>■ ■ static Currency getInstance(String)</li> </ul>	<ul style="list-style-type: none"> <li>■ ■ static Currency getInstance(Locale)</li> <li>■ ■ String getSymbol()</li> <li>■ ■ String getSymbol(Locale)</li> </ul>
<ul style="list-style-type: none"> <li>■ ■ <b>class Date implements java.io.Serializable , Cloneable , Comparable</b></li> <li>■ ■ Date()</li> <li>■ ■ Date(long)</li> <li>■ ■ boolean after(Date)</li> <li>■ ■ boolean before(Date)</li> <li>■ ■ Object clone()</li> </ul>	<ul style="list-style-type: none"> <li>■ ■ int compareTo(Object)</li> <li>■ ■ int compareTo(Date)</li> <li>■ ■ long getTime()</li> <li>■ ■ void setTime(long)</li> </ul>
<ul style="list-style-type: none"> <li>■ ■ <b>abstract class Dictionary</b></li> <li>■ ■ Dictionary()</li> <li>■ ■ abstract Enumeration elements()</li> <li>■ ■ abstract Object get(Object)</li> <li>■ ■ abstract boolean isEmpty()</li> </ul>	<ul style="list-style-type: none"> <li>■ ■ abstract Enumeration keys()</li> <li>■ ■ abstract Object put(Object, Object)</li> <li>■ ■ abstract Object remove(Object)</li> <li>■ ■ abstract int size()</li> </ul>
<ul style="list-style-type: none"> <li>■ ■ <b>class EmptyStackException extends RuntimeException</b></li> <li>■ ■ EmptyStackException()</li> </ul>	
<ul style="list-style-type: none"> <li>■ ■ <b>interface Enumeration</b></li> <li>■ ■ abstract boolean hasMoreElements()</li> </ul>	<ul style="list-style-type: none"> <li>■ ■ abstract Object nextElement()</li> </ul>
<ul style="list-style-type: none"> <li>■ ■ <b>interface EventListener</b></li> </ul>	
<ul style="list-style-type: none"> <li>■ ■ <b>abstract class EventListenerProxy implements EventListener</b></li> <li>■ ■ EventListenerProxy(EventListener)</li> </ul>	<ul style="list-style-type: none"> <li>■ ■ EventListener getListener()</li> </ul>
<ul style="list-style-type: none"> <li>■ ■ <b>class EventObject implements java.io.Serializable</b></li> <li>■ ■ EventObject(Object)</li> <li>■ ■ Object getSource()</li> </ul>	<ul style="list-style-type: none"> <li>■ ■ protected Object source</li> </ul>
<ul style="list-style-type: none"> <li>■ ■ <b>class GregorianCalendar extends Calendar</b></li> <li>■ ■ GregorianCalendar()</li> <li>■ ■ GregorianCalendar(int, int, int)</li> <li>■ ■ GregorianCalendar(int, int, int, int, int)</li> <li>■ ■ GregorianCalendar(int, int, int, int, int, int)</li> <li>■ ■ GregorianCalendar(Locale)</li> <li>■ ■ GregorianCalendar(TimeZone)</li> <li>■ ■ GregorianCalendar(TimeZone, Locale)</li> <li>■ ■ final static int AD</li> <li>■ ■ void add(int, int)</li> <li>■ ■ final static int BC</li> </ul>	<ul style="list-style-type: none"> <li>■ ■ protected void computeFields()</li> <li>■ ■ protected void computeTime()</li> <li>■ ■ int getGreatestMinimum(int)</li> <li>■ ■ final Date getGregorianChange()</li> <li>■ ■ int getLeastMaximum(int)</li> <li>■ ■ int getMaximum(int)</li> <li>■ ■ int getMinimum(int)</li> <li>■ ■ boolean isLeapYear(int)</li> <li>■ ■ void roll(int, boolean)</li> <li>■ ■ void setGregorianChange(Date)</li> </ul>
<ul style="list-style-type: none"> <li>■ ■ <b>class HashMap extends AbstractMap implements java.io.Serializable , Cloneable , Map</b></li> <li>■ ■ HashMap()</li> <li>■ ■ HashMap(int)</li> <li>■ ■ HashMap(int, float)</li> </ul>	<ul style="list-style-type: none"> <li>■ ■ HashMap(Map)</li> <li>■ ■ Object clone()</li> <li>■ ■ Set entrySet()</li> </ul>
<ul style="list-style-type: none"> <li>■ ■ <b>class HashSet extends AbstractSet implements java.io.Serializable , Cloneable , Set</b></li> <li>■ ■ HashSet()</li> <li>■ ■ HashSet(int)</li> <li>■ ■ HashSet(int, float)</li> <li>■ ■ HashSet(Collection)</li> </ul>	<ul style="list-style-type: none"> <li>■ ■ Object clone()</li> <li>■ ■ Iterator iterator()</li> <li>■ ■ int size()</li> </ul>
<ul style="list-style-type: none"> <li>■ ■ <b>class Hashtable extends Dictionary implements java.io.Serializable , Cloneable , Map</b></li> </ul>	

<ul style="list-style-type: none"> <li>■ ■ Hashtable()</li> <li>■ ■ Hashtable(int)</li> <li>■ ■ Hashtable(int,float)</li> <li>■ ■ Hashtable(Map)</li> <li>■ ■ void clear()</li> <li>■ ■ Object clone()</li> <li>■ ■ boolean contains(Object)</li> <li>■ ■ boolean containsKey(Object)</li> <li>■ ■ boolean containsValue(Object)</li> <li>■ ■ Enumeration elements()</li> <li>■ ■ Set entrySet()</li> </ul>	<ul style="list-style-type: none"> <li>■ ■ Object get(Object)</li> <li>■ ■ boolean isEmpty()</li> <li>■ ■ Enumeration keys()</li> <li>■ ■ Set keySet()</li> <li>■ ■ Object put(Object,Object)</li> <li>■ ■ void putAll(Map)</li> <li>■ ■ protected void rehash()</li> <li>■ ■ Object remove(Object)</li> <li>■ ■ int size()</li> <li>■ ■ Collection values()</li> </ul>
<hr/>	
<ul style="list-style-type: none"> <li>■ ■ <b>class IdentityHashMap extends AbstractMap implements java.io.Serializable , Cloneable , Map</b></li> <li>■ ■ IdentityHashMap()</li> <li>■ ■ IdentityHashMap(int)</li> <li>■ ■ IdentityHashMap(Map)</li> </ul>	
<hr/>	
<ul style="list-style-type: none"> <li>■ ■ <b>interface Iterator</b></li> <li>■ ■ abstract boolean hasNext()</li> <li>■ ■ abstract Object next()</li> </ul>	
<hr/>	
<ul style="list-style-type: none"> <li>■ ■ <b>class LinkedHashMap extends HashMap</b></li> <li>■ ■ LinkedHashMap()</li> <li>■ ■ LinkedHashMap(int)</li> <li>■ ■ LinkedHashMap(int,float)</li> </ul>	
<hr/>	
<ul style="list-style-type: none"> <li>■ ■ <b>class LinkedHashMapSet extends HashSet implements java.io.Serializable , Cloneable , Set</b></li> <li>■ ■ LinkedHashMapSet(int,float)</li> <li>■ ■ LinkedHashMapSet(int)</li> <li>■ ■ LinkedHashMapSet(Collection)</li> </ul>	
<hr/>	
<ul style="list-style-type: none"> <li>■ ■ <b>class LinkedList extends AbstractSequentialList implements java.io.Serializable , Cloneable , List</b></li> <li>■ ■ LinkedList()</li> <li>■ ■ LinkedList(Collection)</li> <li>■ ■ void addFirst(Object)</li> <li>■ ■ void addLast(Object)</li> <li>■ ■ Object clone()</li> <li>■ ■ Object getFirst()</li> </ul>	
<hr/>	
<ul style="list-style-type: none"> <li>■ ■ <b>interface List extends Collection</b></li> <li>■ ■ abstract void add(int,Object)</li> <li>■ ■ abstract boolean addAll(int,Collection)</li> <li>■ ■ abstract boolean equals(Object)</li> <li>■ ■ abstract Object get(int)</li> <li>■ ■ abstract int hashCode()</li> <li>■ ■ abstract int indexOf(Object)</li> </ul>	
<hr/>	
<ul style="list-style-type: none"> <li>■ ■ <b>interface ListIterator extends Iterator</b></li> <li>■ ■ abstract void add(Object)</li> <li>■ ■ abstract boolean hasPrevious()</li> <li>■ ■ abstract int nextIndex()</li> </ul>	
<hr/>	
<ul style="list-style-type: none"> <li>■ ■ <b>abstract class ListResourceBundle extends ResourceBundle</b></li> <li>■ ■ ListResourceBundle()</li> <li>■ ■ abstract protected Object[][] getContents()</li> </ul>	
<hr/>	
<ul style="list-style-type: none"> <li>■ ■ <b>final class Locale implements java.io.Serializable , Cloneable</b></li> <li>■ ■ Locale(String)</li> <li>■ ■ Locale(String,String)</li> <li>■ ■ Locale(String,String,String)</li> <li>■ ■ final static Locale CANADA</li> <li>■ ■ final static Locale CANADA_FRENCH</li> <li>■ ■ final static Locale CHINA</li> <li>■ ■ final static Locale CHINESE</li> <li>■ ■ Object clone()</li> <li>■ ■ final static Locale ENGLISH</li> <li>■ ■ final static Locale FRANCE</li> <li>■ ■ final static Locale FRENCH</li> <li>■ ■ final static Locale GERMAN</li> <li>■ ■ final static Locale GERMANY</li> <li>■ ■ static Locale[] getAvailableLocales()</li> <li>■ ■ String getCountry()</li> <li>■ ■ static Locale getDefault()</li> <li>■ ■ final String getDisplayCountry()</li> <li>■ ■ String getDisplayCountry(Locale)</li> <li>■ ■ final String getDisplayLanguage()</li> <li>■ ■ String getDisplayLanguage(Locale)</li> <li>■ ■ final String getDisplayName()</li> <li>■ ■ String getDisplayName(Locale)</li> </ul>	
<hr/>	
<ul style="list-style-type: none"> <li>■ ■ <b>interface Map</b></li> </ul>	

<ul style="list-style-type: none"> <li>■ ■ abstract void clear()</li> <li>■ ■ abstract boolean containsKey(Object)</li> <li>■ ■ abstract boolean containsValue(Object)</li> <li>■ ■ abstract Set entrySet()</li> <li>■ ■ abstract boolean equals(Object)</li> <li>■ ■ abstract Object get(Object)</li> <li>■ ■ abstract int hashCode()</li> </ul>	<ul style="list-style-type: none"> <li>■ ■ abstract boolean isEmpty()</li> <li>■ ■ abstract Set keySet()</li> <li>■ ■ abstract Object put(Object, Object)</li> <li>■ ■ abstract void putAll(Map)</li> <li>■ ■ abstract Object remove(Object)</li> <li>■ ■ abstract int size()</li> <li>■ ■ abstract Collection values()</li> </ul>
<ul style="list-style-type: none"> <li>■ ■ <b>interface Map.Entry</b></li> <li>■ ■ abstract boolean equals(Object)</li> <li>■ ■ abstract Object getKey()</li> <li>■ ■ abstract Object getValue()</li> </ul>	<ul style="list-style-type: none"> <li>■ ■ abstract int hashCode()</li> <li>■ ■ abstract Object setValue(Object)</li> </ul>
<ul style="list-style-type: none"> <li>■ ■ <b>class MissingResourceException extends RuntimeException</b></li> <li>■ ■ MissingResourceException(String, String, String)</li> <li>■ ■ String getClassName()</li> </ul>	<ul style="list-style-type: none"> <li>■ ■ String getKey()</li> </ul>
<ul style="list-style-type: none"> <li>■ ■ <b>class NoSuchElementException extends RuntimeException</b></li> <li>■ ■ NoSuchElementException()</li> </ul>	<ul style="list-style-type: none"> <li>■ ■ NoSuchElementException(String)</li> </ul>
<ul style="list-style-type: none"> <li>■ ■ <b>class Observable</b></li> <li>■ ■ Observable()</li> <li>■ ■ void addObserver(Observer)</li> <li>■ ■ protected void clearChanged()</li> <li>■ ■ int countObservers()</li> <li>■ ■ void deleteObserver(Observer)</li> </ul>	<ul style="list-style-type: none"> <li>■ ■ void deleteObservers()</li> <li>■ ■ boolean hasChanged()</li> <li>■ ■ void notifyObservers()</li> <li>■ ■ void notifyObservers(Object)</li> <li>■ ■ protected void setChanged()</li> </ul>
<ul style="list-style-type: none"> <li>■ ■ <b>interface Observer</b></li> <li>■ ■ abstract void update(Observable, Object)</li> </ul>	
<ul style="list-style-type: none"> <li>■ ■ <b>class Properties extends Hashtable</b></li> <li>■ ■ Properties()</li> <li>■ ■ Properties(Properties)</li> <li>■ ■ protected Properties defaults</li> <li>■ ■ String getProperty(String)</li> <li>■ ■ String getProperty(String, String)</li> <li>■ ■ void list(java.io.PrintStream)</li> </ul>	<ul style="list-style-type: none"> <li>■ ■ void list(java.io.PrintWriter)</li> <li>■ ■ void load(java.io.InputStream) throws java.io.IOException</li> <li>■ ■ Enumeration propertyNames()</li> <li>■ ■ void save(java.io.OutputStream, String)</li> <li>■ ■ Object setProperty(String, String)</li> <li>■ ■ void store(java.io.OutputStream, String) throws java.io.IOException</li> </ul>
<ul style="list-style-type: none"> <li>■ ■ <b>final class PropertyPermission extends java.security.BasicPermission</b></li> <li>■ ■ PropertyPermission(String, String)</li> </ul>	
<ul style="list-style-type: none"> <li>■ ■ <b>class PropertyResourceBundle extends ResourceBundle</b></li> <li>■ ■ PropertyResourceBundle(java.io.InputStream)</li> <li>throws java.io.IOException</li> <li>■ ■ Enumeration getKeys()</li> </ul>	<ul style="list-style-type: none"> <li>■ ■ Object handleGetObject(String)</li> </ul>
<ul style="list-style-type: none"> <li>■ ■ <b>class Random implements java.io.Serializable</b></li> <li>■ ■ Random()</li> <li>■ ■ Random(long)</li> <li>■ ■ protected int next(int)</li> <li>■ ■ boolean nextBoolean()</li> <li>■ ■ void nextBytes(byte[])</li> <li>■ ■ double nextDouble()</li> </ul>	<ul style="list-style-type: none"> <li>■ ■ float nextFloat()</li> <li>■ ■ double nextGaussian()</li> <li>■ ■ int nextInt()</li> <li>■ ■ int nextInt(int)</li> <li>■ ■ long nextLong()</li> <li>■ ■ void setSeed(long)</li> </ul>
<ul style="list-style-type: none"> <li>■ ■ <b>interface RandomAccess</b></li> </ul>	
<ul style="list-style-type: none"> <li>■ ■ <b>abstract class ResourceBundle</b></li> <li>■ ■ ResourceBundle()</li> <li>■ ■ final static ResourceBundle getBundle(String)</li> <li>■ ■ final static ResourceBundle getBundle(String, Locale)</li> <li>■ ■ static ResourceBundle getBundle(String, Locale, ClassLoader)</li> <li>■ ■ abstract Enumeration getKeys()</li> <li>■ ■ Locale getLocale()</li> </ul>	<ul style="list-style-type: none"> <li>■ ■ final Object getObject(String)</li> <li>■ ■ final String getString(String)</li> <li>■ ■ final String[] getStringArray(String)</li> <li>■ ■ abstract protected Object handleGetObject(String)</li> <li>■ ■ protected ResourceBundle parent</li> <li>■ ■ protected void setParent(ResourceBundle)</li> </ul>
<ul style="list-style-type: none"> <li>■ ■ <b>interface Set extends Collection</b></li> <li>■ ■ abstract boolean equals(Object)</li> </ul>	<ul style="list-style-type: none"> <li>■ ■ abstract int hashCode()</li> </ul>
<ul style="list-style-type: none"> <li>■ ■ <b>class SimpleTimeZone extends TimeZone</b></li> <li>■ ■ SimpleTimeZone(int, String)</li> <li>■ ■ SimpleTimeZone(int, String, int, int, int, int, int, int)</li> <li>■ ■ SimpleTimeZone(int, String, int, int, int, int, int, int, int)</li> <li>■ ■ SimpleTimeZone(int, String, int, int, int, int, int, int, int, int)</li> <li>■ ■ int getOffset(int, int, int, int, int)</li> <li>■ ■ int getRawOffset()</li> <li>■ ■ boolean inDaylightTime(Date)</li> <li>■ ■ void setDSTSavings(int)</li> <li>■ ■ void setEndRule(int, int, int)</li> <li>■ ■ void setEndRule(int, int, int, int)</li> </ul>	<ul style="list-style-type: none"> <li>■ ■ void setEndRule(int, int, int, int, boolean)</li> <li>■ ■ void setRawOffset(int)</li> <li>■ ■ void setStartRule(int, int, int)</li> <li>■ ■ void setStartRule(int, int, int, int)</li> <li>■ ■ void setStartRule(int, int, int, int, boolean)</li> <li>■ ■ void setStartYear(int)</li> <li>■ ■ final static int STANDARD_TIME</li> <li>■ ■ boolean useDaylightTime()</li> <li>■ ■ final static int UTC_TIME</li> <li>■ ■ final static int WALL_TIME</li> </ul>
<ul style="list-style-type: none"> <li>■ ■ <b>interface SortedMap extends Map</b></li> <li>■ ■ abstract Comparator comparator()</li> <li>■ ■ abstract Object firstKey()</li> <li>■ ■ abstract SortedMap headMap(Object)</li> </ul>	<ul style="list-style-type: none"> <li>■ ■ abstract Object lastKey()</li> <li>■ ■ abstract SortedMap subMap(Object, Object)</li> <li>■ ■ abstract SortedMap tailMap(Object)</li> </ul>
<ul style="list-style-type: none"> <li>■ ■ <b>interface SortedSet extends Set</b></li> </ul>	

<ul style="list-style-type: none"> <li>■ ■ abstract Comparator comparator()</li> <li>■ ■ abstract Object first()</li> <li>■ ■ abstract SortedSet headSet(Object)</li> </ul>	<ul style="list-style-type: none"> <li>■ ■ abstract Object last()</li> <li>■ ■ abstract SortedSet subSet(Object, Object)</li> <li>■ ■ abstract SortedSet tailSet(Object)</li> </ul>
<hr/>	
<b>■ ■ class Stack extends Vector</b>	
<ul style="list-style-type: none"> <li>■ ■ Stack()</li> <li>■ ■ boolean empty()</li> <li>■ ■ Object peek()</li> </ul>	<ul style="list-style-type: none"> <li>■ ■ Object pop()</li> <li>■ ■ Object push(Object)</li> <li>■ ■ int search(Object)</li> </ul>
<hr/>	
<b>■ ■ class StringTokenizer implements Enumeration</b>	
<ul style="list-style-type: none"> <li>■ ■ StringTokenizer(String)</li> <li>■ ■ StringTokenizer(String, String)</li> <li>■ ■ StringTokenizer(String, String, boolean)</li> <li>■ ■ int countTokens()</li> <li>■ ■ boolean hasMoreElements()</li> </ul>	<ul style="list-style-type: none"> <li>■ ■ boolean hasMoreTokens()</li> <li>■ ■ Object nextElement()</li> <li>■ ■ String nextToken()</li> <li>■ ■ String nextToken(String)</li> </ul>
<hr/>	
<b>■ ■ class Timer</b>	
<ul style="list-style-type: none"> <li>■ ■ Timer()</li> <li>■ ■ Timer(boolean)</li> <li>■ ■ void cancel()</li> <li>■ ■ void schedule(TimerTask, long)</li> <li>■ ■ void schedule(TimerTask, long, long)</li> </ul>	<ul style="list-style-type: none"> <li>■ ■ void schedule(TimerTask, Date)</li> <li>■ ■ void schedule(TimerTask, Date, long)</li> <li>■ ■ void scheduleAtFixedRate(TimerTask, long, long)</li> <li>■ ■ void scheduleAtFixedRate(TimerTask, Date, long)</li> </ul>
<hr/>	
<b>■ ■ abstract class TimerTask implements Runnable</b>	
<ul style="list-style-type: none"> <li>■ ■ protected TimerTask()</li> <li>■ ■ boolean cancel()</li> </ul>	<ul style="list-style-type: none"> <li>■ ■ long scheduledExecutionTime()</li> </ul>
<hr/>	
<b>■ ■ abstract class TimeZone implements java.io.Serializable , Cloneable</b>	
<ul style="list-style-type: none"> <li>■ ■ TimeZone()</li> <li>■ ■ Object clone()</li> <li>■ ■ static String[] getAvailableIDs()</li> <li>■ ■ static String[] getAvailableIDs(int)</li> <li>■ ■ static TimeZone getDefault()</li> <li>■ ■ final String getDisplayName()</li> <li>■ ■ final String getDisplayName(Locale)</li> <li>■ ■ final String getDisplayName(boolean, int)</li> <li>■ ■ String getDisplayName(boolean, int, Locale)</li> <li>■ ■ int getDSTSavings()</li> <li>■ ■ String getID()</li> <li>■ ■ abstract int getOffset(int, int, int, int, int)</li> </ul>	<ul style="list-style-type: none"> <li>■ ■ int getOffset(long)</li> <li>■ ■ abstract int getRawOffset()</li> <li>■ ■ static TimeZone getTimeZone(String)</li> <li>■ ■ boolean hasSameRules(TimeZone)</li> <li>■ ■ abstract boolean inDaylightTime(Date)</li> <li>■ ■ final static int LONG</li> <li>■ ■ static void setDefault(TimeZone)</li> <li>■ ■ void setID(String)</li> <li>■ ■ abstract void setRawOffset(int)</li> <li>■ ■ final static int SHORT</li> <li>■ ■ abstract boolean useDaylightTime()</li> </ul>
<hr/>	
<b>■ ■ class TooManyListenersException extends Exception</b>	
<ul style="list-style-type: none"> <li>■ ■ TooManyListenersException()</li> </ul>	<ul style="list-style-type: none"> <li>■ ■ TooManyListenersException(String)</li> </ul>
<hr/>	
<b>■ ■ class TreeMap extends AbstractMap implements java.io.Serializable , Cloneable , SortedMap</b>	
<ul style="list-style-type: none"> <li>■ ■ TreeMap()</li> <li>■ ■ TreeMap(Comparator)</li> <li>■ ■ TreeMap(Map)</li> <li>■ ■ TreeMap(SortedMap)</li> <li>■ ■ Object clone()</li> <li>■ ■ Comparator comparator()</li> </ul>	<ul style="list-style-type: none"> <li>■ ■ Set entrySet()</li> <li>■ ■ Object firstKey()</li> <li>■ ■ SortedMap headMap(Object)</li> <li>■ ■ Object lastKey()</li> <li>■ ■ SortedMap subMap(Object, Object)</li> <li>■ ■ SortedMap tailMap(Object)</li> </ul>
<hr/>	
<b>■ ■ class TreeSet extends AbstractSet implements java.io.Serializable , Cloneable , SortedSet</b>	
<ul style="list-style-type: none"> <li>■ ■ TreeSet()</li> <li>■ ■ TreeSet(Collection)</li> <li>■ ■ TreeSet(Comparator)</li> <li>■ ■ TreeSet(SortedSet)</li> <li>■ ■ Object clone()</li> <li>■ ■ Comparator comparator()</li> <li>■ ■ Object first()</li> </ul>	<ul style="list-style-type: none"> <li>■ ■ SortedSet headSet(Object)</li> <li>■ ■ Iterator iterator()</li> <li>■ ■ Object last()</li> <li>■ ■ int size()</li> <li>■ ■ SortedSet subSet(Object, Object)</li> <li>■ ■ SortedSet tailSet(Object)</li> </ul>
<hr/>	
<b>■ ■ class Vector extends AbstractList implements java.io.Serializable , Cloneable , List , RandomAccess</b>	
<ul style="list-style-type: none"> <li>■ ■ Vector()</li> <li>■ ■ Vector(int)</li> <li>■ ■ Vector(int, int)</li> <li>■ ■ Vector(Collection)</li> <li>■ ■ void addElement(Object)</li> <li>■ ■ int capacity()</li> <li>■ ■ protected int capacityIncrement</li> <li>■ ■ Object clone()</li> <li>■ ■ void copyInto(Object[])</li> <li>■ ■ Object elementAt(int)</li> <li>■ ■ protected int elementCount</li> <li>■ ■ protected Object[] elementData</li> <li>■ ■ Enumeration elements()</li> <li>■ ■ void ensureCapacity(int)</li> </ul>	<ul style="list-style-type: none"> <li>■ ■ Object firstElement()</li> <li>■ ■ Object get(int)</li> <li>■ ■ int indexOf(Object, int)</li> <li>■ ■ void insertElementAt(Object, int)</li> <li>■ ■ Object lastElement()</li> <li>■ ■ int lastIndexOf(Object, int)</li> <li>■ ■ void removeAllElements()</li> <li>■ ■ boolean removeElement(Object)</li> <li>■ ■ void removeElementAt(int)</li> <li>■ ■ void setElementAt(Object, int)</li> <li>■ ■ void setSize(int)</li> <li>■ ■ int size()</li> <li>■ ■ void trimToSize()</li> </ul>
<hr/>	
<b>■ ■ class WeakHashMap extends AbstractMap implements Map</b>	
<ul style="list-style-type: none"> <li>■ ■ WeakHashMap()</li> <li>■ ■ WeakHashMap(int)</li> <li>■ ■ WeakHashMap(int, float)</li> </ul>	<ul style="list-style-type: none"> <li>■ ■ WeakHashMap(Map)</li> <li>■ ■ Set entrySet()</li> </ul>

## 999.3.14

## java.util.jar

---

**package java.util.jar**
**class Attributes implements Cloneable , java.util.Map**

- |                                                                                                                                                                                                                                                                                                                                                                      |                                                                                                                                                                                                                                                                                                                                                                                                                   |
|----------------------------------------------------------------------------------------------------------------------------------------------------------------------------------------------------------------------------------------------------------------------------------------------------------------------------------------------------------------------|-------------------------------------------------------------------------------------------------------------------------------------------------------------------------------------------------------------------------------------------------------------------------------------------------------------------------------------------------------------------------------------------------------------------|
| <ul style="list-style-type: none"> <li>■ Attributes()</li> <li>■ Attributes(int)</li> <li>■ Attributes(Attributes)</li> <li>■ void clear()</li> <li>■ Object clone()</li> <li>■ boolean containsKey(Object)</li> <li>■ boolean containsValue(Object)</li> <li>■ java.util.Set entrySet()</li> <li>■ Object get(Object)</li> <li>■ String getValue(String)</li> </ul> | <ul style="list-style-type: none"> <li>■ String getValue(Attributes.Name)</li> <li>■ boolean isEmpty()</li> <li>■ java.util.Set keySet()</li> <li>■ protected java.util.Map map</li> <li>■ Object put(Object, Object)</li> <li>■ void putAll(java.util.Map)</li> <li>■ String putValue(String, String)</li> <li>■ Object remove(Object)</li> <li>■ int size()</li> <li>■ java.util.Collection values()</li> </ul> |
|----------------------------------------------------------------------------------------------------------------------------------------------------------------------------------------------------------------------------------------------------------------------------------------------------------------------------------------------------------------------|-------------------------------------------------------------------------------------------------------------------------------------------------------------------------------------------------------------------------------------------------------------------------------------------------------------------------------------------------------------------------------------------------------------------|

**class Attributes.Name**

- |                                                                                                                                                                                                                                                                                                                                                                                                                                                                                                                                                        |                                                                                                                                                                                                                                                                                                                                                                                                                                                                                                                                                                                      |
|--------------------------------------------------------------------------------------------------------------------------------------------------------------------------------------------------------------------------------------------------------------------------------------------------------------------------------------------------------------------------------------------------------------------------------------------------------------------------------------------------------------------------------------------------------|--------------------------------------------------------------------------------------------------------------------------------------------------------------------------------------------------------------------------------------------------------------------------------------------------------------------------------------------------------------------------------------------------------------------------------------------------------------------------------------------------------------------------------------------------------------------------------------|
| <ul style="list-style-type: none"> <li>■ Attributes.Name(String)</li> <li>■ final static Attributes.Name CLASS_PATH</li> <li>■ final static Attributes.Name CONTENT_TYPE</li> <li>■ final static Attributes.Name EXTENSION_INSTALLATION</li> <li>■ final static Attributes.Name EXTENSION_LIST</li> <li>■ final static Attributes.Name EXTENSION_NAME</li> <li>■ final static Attributes.Name IMPLEMENTATION_TITLE</li> <li>■ final static Attributes.Name IMPLEMENTATION_URL</li> <li>■ final static Attributes.Name IMPLEMENTATION_VENDOR</li> </ul> | <ul style="list-style-type: none"> <li>■ final static Attributes.Name IMPLEMENTATION_VENDOR_ID</li> <li>■ final static Attributes.Name IMPLEMENTATION_VERSION</li> <li>■ final static Attributes.Name MAIN_CLASS</li> <li>■ final static Attributes.Name MANIFEST_VERSION</li> <li>■ final static Attributes.Name SEALED</li> <li>■ final static Attributes.Name SIGNATURE_VERSION</li> <li>■ final static Attributes.Name SPECIFICATION_TITLE</li> <li>■ final static Attributes.Name SPECIFICATION_VENDOR</li> <li>■ final static Attributes.Name SPECIFICATION_VERSION</li> </ul> |
|--------------------------------------------------------------------------------------------------------------------------------------------------------------------------------------------------------------------------------------------------------------------------------------------------------------------------------------------------------------------------------------------------------------------------------------------------------------------------------------------------------------------------------------------------------|--------------------------------------------------------------------------------------------------------------------------------------------------------------------------------------------------------------------------------------------------------------------------------------------------------------------------------------------------------------------------------------------------------------------------------------------------------------------------------------------------------------------------------------------------------------------------------------|

**class JarEntry extends java.util.zip.ZipEntry**

- |                                                                                                                                                |                                                                                                                                                                         |
|------------------------------------------------------------------------------------------------------------------------------------------------|-------------------------------------------------------------------------------------------------------------------------------------------------------------------------|
| <ul style="list-style-type: none"> <li>■ JarEntry(String)</li> <li>■ JarEntry(JarEntry)</li> <li>■ JarEntry(java.util.zip.ZipEntry)</li> </ul> | <ul style="list-style-type: none"> <li>■ Attributes getAttributes() throws java.io.IOException</li> <li>■ java.security.cert.Certificate[] getCertificates()</li> </ul> |
|------------------------------------------------------------------------------------------------------------------------------------------------|-------------------------------------------------------------------------------------------------------------------------------------------------------------------------|

**class JarException extends java.util.zip.ZipException**

- |                                                                    |                                                                          |
|--------------------------------------------------------------------|--------------------------------------------------------------------------|
| <ul style="list-style-type: none"> <li>■ JarException()</li> </ul> | <ul style="list-style-type: none"> <li>■ JarException(String)</li> </ul> |
|--------------------------------------------------------------------|--------------------------------------------------------------------------|

**class JarFile extends java.util.zip.ZipFile**

- |                                                                                                                                                                                                                                                                                                                                                                          |                                                                                                                                                                                                                                                                |
|--------------------------------------------------------------------------------------------------------------------------------------------------------------------------------------------------------------------------------------------------------------------------------------------------------------------------------------------------------------------------|----------------------------------------------------------------------------------------------------------------------------------------------------------------------------------------------------------------------------------------------------------------|
| <ul style="list-style-type: none"> <li>■ JarFile(java.io.File) throws java.io.IOException</li> <li>■ JarFile(java.io.File, boolean) throws java.io.IOException</li> <li>■ JarFile(java.io.File, boolean, int) throws java.io.IOException</li> <li>■ JarFile(String) throws java.io.IOException</li> <li>■ JarFile(String, boolean) throws java.io.IOException</li> </ul> | <ul style="list-style-type: none"> <li>■ <input type="checkbox"/> java.util.Enumeration entries()</li> <li>■ JarEntry getJarEntry(String)</li> <li>■ Manifest getManifest() throws java.io.IOException</li> <li>■ final static String MANIFEST_NAME</li> </ul> |
|--------------------------------------------------------------------------------------------------------------------------------------------------------------------------------------------------------------------------------------------------------------------------------------------------------------------------------------------------------------------------|----------------------------------------------------------------------------------------------------------------------------------------------------------------------------------------------------------------------------------------------------------------|

**class JarInputStream extends java.util.zip.ZipInputStream**

- |                                                                                                                                                                                                       |                                                                                                                                             |
|-------------------------------------------------------------------------------------------------------------------------------------------------------------------------------------------------------|---------------------------------------------------------------------------------------------------------------------------------------------|
| <ul style="list-style-type: none"> <li>■ JarInputStream(java.io.InputStream) throws java.io.IOException</li> <li>■ JarInputStream(java.io.InputStream, boolean) throws java.io.IOException</li> </ul> | <ul style="list-style-type: none"> <li>■ Manifest getManifest()</li> <li>■ JarEntry getNextJarEntry() throws java.io.IOException</li> </ul> |
|-------------------------------------------------------------------------------------------------------------------------------------------------------------------------------------------------------|---------------------------------------------------------------------------------------------------------------------------------------------|

**class JarOutputStream extends java.util.zip.ZipOutputStream**

- |                                                                                                                      |                                                                                                                                |
|----------------------------------------------------------------------------------------------------------------------|--------------------------------------------------------------------------------------------------------------------------------|
| <ul style="list-style-type: none"> <li>■ JarOutputStream(java.io.OutputStream) throws java.io.IOException</li> </ul> | <ul style="list-style-type: none"> <li>■ JarOutputStream(java.io.OutputStream, Manifest) throws java.io.IOException</li> </ul> |
|----------------------------------------------------------------------------------------------------------------------|--------------------------------------------------------------------------------------------------------------------------------|

**class Manifest implements Cloneable**

- |                                                                                                                                                                                                                    |                                                                                                                                                                                                                                                                                                                  |
|--------------------------------------------------------------------------------------------------------------------------------------------------------------------------------------------------------------------|------------------------------------------------------------------------------------------------------------------------------------------------------------------------------------------------------------------------------------------------------------------------------------------------------------------|
| <ul style="list-style-type: none"> <li>■ Manifest()</li> <li>■ Manifest(java.io.InputStream) throws java.io.IOException</li> <li>■ Manifest(Manifest)</li> <li>■ void clear()</li> <li>■ Object clone()</li> </ul> | <ul style="list-style-type: none"> <li>■ Attributes getAttributes(String)</li> <li>■ java.util.Map getEntries()</li> <li>■ Attributes getMainAttributes()</li> <li>■ void read(java.io.InputStream) throws java.io.IOException</li> <li>■ void write(java.io.OutputStream) throws java.io.IOException</li> </ul> |
|--------------------------------------------------------------------------------------------------------------------------------------------------------------------------------------------------------------------|------------------------------------------------------------------------------------------------------------------------------------------------------------------------------------------------------------------------------------------------------------------------------------------------------------------|

## 999.3.15

## java.util.zip

---

**package java.util.zip**
**class Adler32 implements Checksum**

- |                                                                                                                  |                                                                                                                                              |
|------------------------------------------------------------------------------------------------------------------|----------------------------------------------------------------------------------------------------------------------------------------------|
| <ul style="list-style-type: none"> <li>■ Adler32()</li> <li>■ long getValue()</li> <li>■ void reset()</li> </ul> | <ul style="list-style-type: none"> <li>■ void update(byte[])</li> <li>■ void update(byte[], int, int)</li> <li>■ void update(int)</li> </ul> |
|------------------------------------------------------------------------------------------------------------------|----------------------------------------------------------------------------------------------------------------------------------------------|

**class CheckedInputStream extends java.io.FilterInputStream**

- |                                                                                                       |                                                                            |
|-------------------------------------------------------------------------------------------------------|----------------------------------------------------------------------------|
| <ul style="list-style-type: none"> <li>■ CheckedInputStream(java.io.InputStream, Checksum)</li> </ul> | <ul style="list-style-type: none"> <li>■ Checksum getChecksum()</li> </ul> |
|-------------------------------------------------------------------------------------------------------|----------------------------------------------------------------------------|

**class CheckedOutputStream extends java.io.FilterOutputStream**

- |                                                                                                         |                                                                            |
|---------------------------------------------------------------------------------------------------------|----------------------------------------------------------------------------|
| <ul style="list-style-type: none"> <li>■ CheckedOutputStream(java.io.OutputStream, Checksum)</li> </ul> | <ul style="list-style-type: none"> <li>■ Checksum getChecksum()</li> </ul> |
|---------------------------------------------------------------------------------------------------------|----------------------------------------------------------------------------|

**interface Checksum**

- |                                                                                                               |                                                                                                                                 |
|---------------------------------------------------------------------------------------------------------------|---------------------------------------------------------------------------------------------------------------------------------|
| <ul style="list-style-type: none"> <li>■ abstract long getValue()</li> <li>■ abstract void reset()</li> </ul> | <ul style="list-style-type: none"> <li>■ abstract void update(byte[], int, int)</li> <li>■ abstract void update(int)</li> </ul> |
|---------------------------------------------------------------------------------------------------------------|---------------------------------------------------------------------------------------------------------------------------------|

**class CRC32 implements Checksum**

- |                                                                                                                |                                                                                                                                              |
|----------------------------------------------------------------------------------------------------------------|----------------------------------------------------------------------------------------------------------------------------------------------|
| <ul style="list-style-type: none"> <li>■ CRC32()</li> <li>■ long getValue()</li> <li>■ void reset()</li> </ul> | <ul style="list-style-type: none"> <li>■ void update(byte[])</li> <li>■ void update(byte[], int, int)</li> <li>■ void update(int)</li> </ul> |
|----------------------------------------------------------------------------------------------------------------|----------------------------------------------------------------------------------------------------------------------------------------------|

**class DataFormatException extends Exception**

- |                                                                           |                                                                                 |
|---------------------------------------------------------------------------|---------------------------------------------------------------------------------|
| <ul style="list-style-type: none"> <li>■ DataFormatException()</li> </ul> | <ul style="list-style-type: none"> <li>■ DataFormatException(String)</li> </ul> |
|---------------------------------------------------------------------------|---------------------------------------------------------------------------------|

---

<b>■ ■ class Deflater</b>	
■ ■ Deflater()	■ ■ boolean finished()
■ ■ Deflater(int)	■ ■ int getAdler()
■ ■ Deflater(int,boolean)	■ ■ int getTotalIn()
■ ■ final static int BEST_COMPRESSION	■ ■ int getTotalOut()
■ ■ final static int BEST_SPEED	■ ■ final static int HUFFMAN_ONLY
■ ■ final static int DEFAULT_COMPRESSION	■ ■ boolean needsInput()
■ ■ final static int DEFAULT_STRATEGY	■ ■ final static int NO_COMPRESSION
■ ■ int deflate(byte[])	■ ■ void reset()
■ ■ int deflate(byte[],int,int)	■ ■ void setDictionary(byte[])
■ ■ final static int DEFLATED	■ ■ void setDictionary(byte[],int,int)
■ ■ void end()	■ ■ void setInput(byte[])
■ ■ final static int FILTERED	■ ■ void setInput(byte[],int,int)
■ ■ protected void finalize()	■ ■ void setLevel(int)
■ ■ void finish()	■ ■ void setStrategy(int)
<hr/>	
<b>■ ■ class DeflaterOutputStream extends java.io.FilterOutputStream</b>	
■ ■ DeflaterOutputStream(java.io.OutputStream)	■ ■ protected Deflater def
■ ■ DeflaterOutputStream(java.io.OutputStream,Deflater)	■ ■ protected void deflate() throws java.io.IOException
■ ■ DeflaterOutputStream(java.io.OutputStream,Deflater,int)	■ ■ void finish() throws java.io.IOException
■ ■ protected byte[] buf	
<hr/>	
<b>■ ■ class GZIPInputStream extends InflaterInputStream</b>	
■ ■ GZIPInputStream(java.io.InputStream) throws java.io.IOException	■ ■ protected boolean eos
■ ■ GZIPInputStream(java.io.InputStream,int) throws java.io.IOException	■ ■ final static int GZIP_MAGIC
■ ■ protected CRC32 crc	
<hr/>	
<b>■ ■ class GZIPOutputStream extends DeflaterOutputStream</b>	
■ ■ GZIPOutputStream(java.io.OutputStream) throws java.io.IOException	■ ■ protected CRC32 crc
■ ■ GZIPOutputStream(java.io.OutputStream,int)	
throws java.io.IOException	
<hr/>	
<b>■ ■ class Inflater</b>	
■ ■ Inflater()	■ ■ int inflate(byte[]) throws DataFormatException
■ ■ Inflater(boolean)	■ ■ int inflate(byte[],int,int) throws DataFormatException
■ ■ void end()	■ ■ boolean needsDictionary()
■ ■ protected void finalize()	■ ■ boolean needsInput()
■ ■ boolean finished()	■ ■ void reset()
■ ■ int getAdler()	■ ■ void setDictionary(byte[])
■ ■ int getRemaining()	■ ■ void setDictionary(byte[],int,int)
■ ■ int getTotalIn()	■ ■ void setInput(byte[])
■ ■ int getTotalOut()	■ ■ void setInput(byte[],int,int)
<hr/>	
<b>■ ■ class InflaterInputStream extends java.io.FilterInputStream</b>	
■ ■ InflaterInputStream(java.io.InputStream)	■ ■ protected void fill() throws java.io.IOException
■ ■ InflaterInputStream(java.io.InputStream,Inflater)	■ ■ protected Inflater inf
■ ■ InflaterInputStream(java.io.InputStream,Inflater,int)	■ ■ protected int len
■ ■ protected byte[] buf	
<hr/>	
<b>■ ■ class ZipEntry implements Cloneable , ZipConstants</b>	
■ ■ ZipEntry(String)	■ ■ long getTime()
■ ■ ZipEntry(ZipEntry)	■ ■ boolean isDirectory()
■ ■ Object clone()	■ ■ void setComment(String)
■ ■ final static int DEFLATED	■ ■ void setCompressedSize(long)
■ ■ String getComment()	■ ■ void setCrc(long)
■ ■ long getCompressedSize()	■ ■ void setExtra(byte[])
■ ■ long getCrc()	■ ■ void setMethod(int)
■ ■ byte[] getExtra()	■ ■ void setSize(long)
■ ■ int getMethod()	■ ■ void setTime(long)
■ ■ String getName()	■ ■ final static int STORED
■ ■ long getSize()	
<hr/>	
<b>■ ■ class ZipException extends java.io.IOException</b>	
■ ■ ZipException()	■ ■ ZipException(String)
<hr/>	
<b>■ ■ class ZipFile implements ZipConstants</b>	
■ ■ ZipFile(java.io.File) throws java.io.IOException	■ ■ ZipEntry getEntry(String)
■ ■ ZipFile(java.io.File,int) throws java.io.IOException	■ ■ java.io.InputStream getInputStream(ZipEntry)
■ ■ ZipFile(String) throws java.io.IOException	throws java.io.IOException
■ ■ void close() throws java.io.IOException	■ ■ String getName()
■ ■ java.util.Enumeration entries()	■ ■ final static int OPEN_DELETE
■ ■ protected void finalize() throws java.io.IOException	■ ■ final static int OPEN_READ
	■ ■ int size()
<hr/>	
<b>■ ■ class ZipInputStream extends InflaterInputStream implements ZipConstants</b>	
■ ■ ZipInputStream(java.io.InputStream)	■ ■ protected ZipEntry createZipEntry(String)
■ ■ void closeEntry() throws java.io.IOException	■ ■ ZipEntry getNextEntry() throws java.io.IOException
<hr/>	
<b>■ ■ class ZipOutputStream extends DeflaterOutputStream implements ZipConstants</b>	

---

- ■ ZipOutputStream(java.io.OutputStream)
- ■ void closeEntry() throws java.io.IOException
- ■ final static int DEFLATED
- ■ void putNextEntry(ZipEntry) throws java.io.IOException
- ■ void setComment(String)
- ■ void setLevel(int)
- ■ void setMethod(int)
- ■ final static int STORED

## 999.3.16

**javax.microedition.io**

---

□ ■ **package javax.microedition.io**

□ ■ **interface CommConnection extends StreamConnection**

□ ■ abstract int getBaudRate()

□ ■ abstract int setBaudRate(int)

□ ■ **interface Connection**

□ ■ abstract void close() throws java.io.IOException

□ ■ **class ConnectionNotFoundException extends java.io.IOException**

□ ■ ConnectionNotFoundException()

□ ■ ConnectionNotFoundException(String)

□ ■ **class Connector**

□ ■ static Connection open(String) throws java.io.IOException

□ ■ static Connection open(String,int) throws java.io.IOException

□ ■ static Connection open(String,int,boolean) throws java.io.IOException

□ ■ static java.io.DataInputStream openDataInputStream(String)

throws java.io.IOException

□ ■ static java.io.DataOutputStream openDataOutputStream(String)

throws java.io.IOException

□ ■ **interface ContentConnection extends StreamConnection**

□ ■ abstract String getEncoding()

□ ■ abstract long getLength()

□ ■ static java.io.InputStream openInputStream(String) throws java.io.IOException

□ ■ static java.io.OutputStream openOutputStream(String)

throws java.io.IOException

□ ■ final static int READ

□ ■ final static int READ\_WRITE

□ ■ final static int WRITE

□ ■ abstract String getType()

□ ■ **interface Datagram extends java.io.DataInput , java.io.DataOutput**

□ ■ abstract String getAddress()

□ ■ abstract byte[] getData()

□ ■ abstract int getLength()

□ ■ abstract int getOffset()

□ ■ abstract void reset()

□ ■ abstract void setAddress(String) throws java.io.IOException

□ ■ abstract void setAddress(Datagram)

□ ■ abstract void setData(byte[],int,int)

□ ■ abstract void setLength(int)

□ ■ **interface DatagramConnection extends Connection**

□ ■ abstract int getMaximumLength() throws java.io.IOException

□ ■ abstract int getNominalLength() throws java.io.IOException

□ ■ abstract Datagram newDatagram(byte[],int)

throws java.io.IOException

□ ■ abstract Datagram newDatagram(byte[],int,String)

throws java.io.IOException

□ ■ abstract Datagram newDatagram(int) throws java.io.IOException

□ ■ abstract Datagram newDatagram(int,String)

throws java.io.IOException

□ ■ abstract void receive(Datagram) throws java.io.IOException

□ ■ abstract void send(Datagram) throws java.io.IOException

□ ■ **interface HttpConnection extends ContentConnection**

□ ■ final static String GET

□ ■ abstract long getDate() throws java.io.IOException

□ ■ abstract long getExpiration() throws java.io.IOException

□ ■ abstract String getFile()

□ ■ abstract String getHeaderField(int) throws java.io.IOException

□ ■ abstract String getHeaderField(String) throws java.io.IOException

□ ■ abstract long getHeaderFieldDate(String,long)

throws java.io.IOException

□ ■ abstract int getHeaderFieldInt(String,int) throws java.io.IOException

□ ■ abstract String getHeaderFieldKey(int) throws java.io.IOException

□ ■ abstract String getHost()

□ ■ abstract long getLastModified() throws java.io.IOException

□ ■ abstract int getPort()

□ ■ abstract String getProtocol()

□ ■ abstract String getQuery()

□ ■ abstract String getRef()

□ ■ abstract String getRequestMethod()

□ ■ abstract String getRequestProperty(String)

□ ■ abstract int getResponseCode() throws java.io.IOException

□ ■ abstract String getResponseMessage() throws java.io.IOException

□ ■ abstract String getURL()

□ ■ final static String HEAD

□ ■ final static int HTTP\_ACCEPTED

□ ■ final static int HTTP\_BAD\_GATEWAY

□ ■ final static int HTTP\_BAD\_METHOD

□ ■ final static int HTTP\_BAD\_REQUEST

□ ■ final static int HTTP\_CLIENT\_TIMEOUT

□ ■ final static int HTTP\_CONFLICT

□ ■ final static int HTTP\_CREATED

□ ■ final static int HTTP\_ENTITY\_TOO\_LARGE

□ ■ final static int HTTP\_EXPECT\_FAILED

□ ■ final static int HTTP\_FORBIDDEN

□ ■ final static int HTTP\_GATEWAY\_TIMEOUT

□ ■ final static int HTTP\_GONE

□ ■ final static int HTTP\_INTERNAL\_ERROR

□ ■ final static int HTTP\_LENGTH\_REQUIRED

□ ■ final static int HTTP\_MOVED\_PERM

□ ■ final static int HTTP\_MOVED\_TEMP

□ ■ final static int HTTP\_MULT\_CHOICE

□ ■ final static int HTTP\_NO\_CONTENT

□ ■ final static int HTTP\_NOT\_ACCEPTABLE

□ ■ final static int HTTP\_REQ\_AUTHORITY

□ ■ final static int HTTP\_NOT\_FOUND

□ ■ final static int HTTP\_NOT\_IMPLEMENTED

□ ■ final static int HTTP\_NOT\_MODIFIED

□ ■ final static int HTTP\_OK

□ ■ final static int HTTP\_PARTIAL

□ ■ final static int HTTP\_PAYMENT\_REQUIRED

□ ■ final static int HTTP\_PRECON\_FAILED

□ ■ final static int HTTP\_PROXY\_AUTH

□ ■ final static int HTTP\_REQ\_TOO\_LONG

□ ■ final static int HTTP\_RESET

□ ■ final static int HTTP\_SEE\_OTHER

□ ■ final static int HTTP\_TEMP\_REDIRECT

□ ■ final static int HTTP\_UNAUTHORIZED

□ ■ final static int HTTP\_UNAVAILABLE

□ ■ final static int HTTP\_UNSUPPORTED\_RANGE

□ ■ final static int HTTP\_UNSUPPORTED\_TYPE

□ ■ final static int HTTP\_USE\_PROXY

□ ■ final static int HTTP\_VERSION

□ ■ final static String POST

□ ■ abstract void setRequestMethod(String) throws java.io.IOException

□ ■ abstract void setRequestProperty(String,String)

throws java.io.IOException

□ ■ **interface HttpsConnection extends HttpConnection**



<ul style="list-style-type: none"> <li>□ ■ abstract SecurityInfo getSecurityInfo() throws java.io.IOException</li> </ul>	
<ul style="list-style-type: none"> <li>□ ■ <b>interface InputConnection extends Connection</b></li> <li>□ ■ abstract java.io.DataInputStream openDataInputStream() throws java.io.IOException</li> </ul>	<ul style="list-style-type: none"> <li>□ ■ abstract java.io.InputStream openInputStream() throws java.io.IOException</li> </ul>
<ul style="list-style-type: none"> <li>□ ■ <b>interface OutputConnection extends Connection</b></li> <li>□ ■ abstract java.io.DataOutputStream openDataOutputStream() throws java.io.IOException</li> </ul>	<ul style="list-style-type: none"> <li>□ ■ abstract java.io.OutputStream openOutputStream() throws java.io.IOException</li> </ul>
<ul style="list-style-type: none"> <li>□ ■ <b>interface SecureConnection extends SocketConnection</b></li> <li>□ ■ abstract SecurityInfo getSecurityInfo() throws java.io.IOException</li> </ul>	
<ul style="list-style-type: none"> <li>□ ■ <b>interface SecurityInfo</b></li> <li>□ ■ abstract String getCipherSuite()</li> <li>□ ■ abstract String getProtocolName()</li> </ul>	<ul style="list-style-type: none"> <li>□ ■ abstract String getProtocolVersion()</li> <li>□ ■ abstract javax.microedition.pki.Certificate getServerCertificate()</li> </ul>
<ul style="list-style-type: none"> <li>□ ■ <b>interface ServerSocketConnection extends StreamConnectionNotifier</b></li> <li>□ ■ abstract String getLocalAddress() throws java.io.IOException</li> </ul>	<ul style="list-style-type: none"> <li>□ ■ abstract int getLocalPort() throws java.io.IOException</li> </ul>
<ul style="list-style-type: none"> <li>□ ■ <b>interface SocketConnection extends StreamConnection</b></li> <li>□ ■ final static byte DELAY</li> <li>□ ■ abstract String getAddress() throws java.io.IOException</li> <li>□ ■ abstract String getLocalAddress() throws java.io.IOException</li> <li>□ ■ abstract int getLocalPort() throws java.io.IOException</li> <li>□ ■ abstract int getPort() throws java.io.IOException</li> <li>□ ■ abstract int getSocketOption(byte) throws java.io.IOException</li> </ul>	<ul style="list-style-type: none"> <li>□ ■ final static byte KEEPALIVE</li> <li>□ ■ final static byte LINGER</li> <li>□ ■ final static byte RCVBUF</li> <li>□ ■ abstract void setSocketOption(byte,int) throws java.io.IOException</li> <li>□ ■ final static byte SNDBUF</li> </ul>
<ul style="list-style-type: none"> <li>□ ■ <b>interface StreamConnection extends InputConnection , OutputConnection</b></li> </ul>	
<ul style="list-style-type: none"> <li>□ ■ <b>interface StreamConnectionNotifier extends Connection</b></li> <li>□ ■ abstract StreamConnection acceptAndOpen() throws java.io.IOException</li> </ul>	
<ul style="list-style-type: none"> <li>□ ■ <b>interface UDPPDatagramConnection extends DatagramConnection</b></li> <li>□ ■ abstract String getLocalAddress() throws java.io.IOException</li> </ul>	<ul style="list-style-type: none"> <li>□ ■ abstract int getLocalPort() throws java.io.IOException</li> </ul>

## 999.3.17

**javax.microedition.pki**

<ul style="list-style-type: none"> <li>□ ■ <b>package javax.microedition.pki</b></li> <li>□ ■ <b>interface Certificate</b></li> <li>□ ■ abstract String getIssuer()</li> <li>□ ■ abstract long getNotAfter()</li> <li>□ ■ abstract long getNotBefore()</li> <li>□ ■ abstract String getSerialNumber()</li> </ul>	<ul style="list-style-type: none"> <li>□ ■ abstract String getSigAlgName()</li> <li>□ ■ abstract String getSubject()</li> <li>□ ■ abstract String getType()</li> <li>□ ■ abstract String getVersion()</li> </ul>
<ul style="list-style-type: none"> <li>□ ■ <b>class CertificateException extends java.io.IOException</b></li> <li>□ ■ CertificateException(String,Certificate,byte)</li> <li>□ ■ CertificateException(Certificate,byte)</li> <li>□ ■ final static byte BAD_EXTENSIONS</li> <li>□ ■ final static byte BROKEN_CHAIN</li> <li>□ ■ final static byte CERTIFICATE_CHAIN_TOO_LONG</li> <li>□ ■ final static byte EXPIRED</li> <li>□ ■ Certificate getCertificate()</li> <li>□ ■ byte getReason()</li> <li>□ ■ final static byte INAPPROPRIATE_KEY_USAGE</li> </ul>	<ul style="list-style-type: none"> <li>□ ■ final static byte MISSING_SIGNATURE</li> <li>□ ■ final static byte NOT_YET_VALID</li> <li>□ ■ final static byte ROOT_CA_EXPIRED</li> <li>□ ■ final static byte SITENAME_MISMATCH</li> <li>□ ■ final static byte UNAUTHORIZED_INTERMEDIATE_CA</li> <li>□ ■ final static byte UNRECOGNIZED_ISSUER</li> <li>□ ■ final static byte UNSUPPORTED_PUBLIC_KEY_TYPE</li> <li>□ ■ final static byte UNSUPPORTED_SIGALG</li> <li>□ ■ final static byte VERIFICATION_FAILED</li> </ul>

## 999.3.18

**javax.security.auth.x500**

<ul style="list-style-type: none"> <li>■ ■ <b>package javax.security.auth.x500</b></li> <li>■ ■ <b>final class X500Principal implements java.io.Serializable , java.security.Principal</b></li> <li>■ ■ X500Principal(byte[])</li> <li>■ ■ X500Principal(java.io.InputStream)</li> <li>■ ■ X500Principal(String)</li> <li>■ ■ final static String CANONICAL</li> <li>■ ■ byte[] getEncoded()</li> </ul>	<ul style="list-style-type: none"> <li>■ ■ String getName()</li> <li>■ ■ String getName(String)</li> <li>■ ■ final static String RFC1779</li> <li>■ ■ final static String RFC2253</li> </ul>
---------------------------------------------------------------------------------------------------------------------------------------------------------------------------------------------------------------------------------------------------------------------------------------------------------------------------------------------------------------------------------------------------------	----------------------------------------------------------------------------------------------------------------------------------------------------------------------------------------------

## 999.4

**References**

- [1] *The Java Virtual Machine Specification*  
Tim Lindholm and Frank Yellin, Addison Wesley, ISBN 0-201-63452-X
- [2] *Downloadable Execution Environments*  
<http://www.osgi.org/Specifications/HomePage>

- 
- [3] *J2ME, Java 2 Micro Edition*  
<http://java.sun.com/j2me>
  - [4] *CDC, Connected Device Configuration*  
<http://java.sun.com/products/cdc>
  - [5] *CLDC, Connected Limited Device Configuration*  
<http://java.sun.com/products/cldc>
  - [6] *Foundation Profile*  
<http://java.sun.com/products/foundation>  
This external specification is © Copyright 2000 Sun Microsystems, Inc.



**End Of Document**