

RED HAT  
**SUMMIT**

# Cloud Solutions for Enterprise Mobility

Powered by the Red Hat Mobile Application Platform on OpenShift

James Mernin  
Chief Technology Officer, Red Hat Mobile  
May 3, 2017

Mobile Context

Cloud Solutions

Enterprise Features

OpenShift

Enterprise Case Study



ACCELERATE APPLICATION  
DELIVERY

MODERN (CLOUD NATIVE)  
APPLICATIONS

NEW APPS, SERVICES, BUSINESS  
MODELS

**RED HAT®**  
**MOBILE APPLICATION  
PLATFORM**

DELIVER MOBILE APPS FASTER

MOBILIZE EXISTING APPS OR  
BUILD NEXT GEN APPS

MOBILE COMPONENT FOR EVERY  
NEW APP



NETWORKING & SECURITY

BUSINESS CONTINUITY  
DISASTER RECOVERY

SUPPORT & MAINTENANCE

**RED HAT®**  
**MOBILE APPLICATION  
PLATFORM**

SPEED OF DEPLOYMENT

FLEXIBLE, OPEN, MODULAR

ENTERPRISE FEATURES

- FeedHenry (2011-2014)
  - FH 1: Server-side JS (Rhino), Solaris Zones
  - FH 2: Node.js, Containers/LXC, Cloud Foundry
  - FH 3: Teams, Lifecycle Mgt, MBaaS Services
  - **Acquired by Red Hat (October 2014)**
- Red Hat Mobile (2015-2016)
  - Red Hat Mobile Application Platform (RHMAP)
  - RHMAP 3: SaaS, targeting OpenShift 2 & 3
  - RHMAP 4: OpenShift 3, On-Premise, SaaS
  - Community Brand: FeedHenry



**RED HAT**<sup>®</sup>  
**MOBILE**

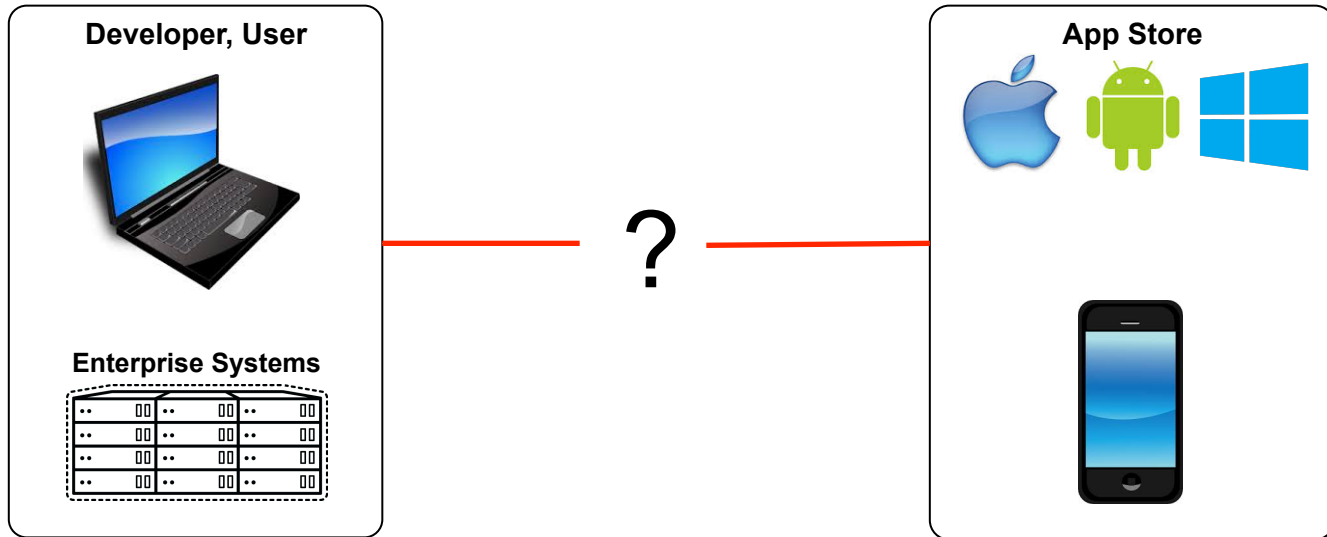

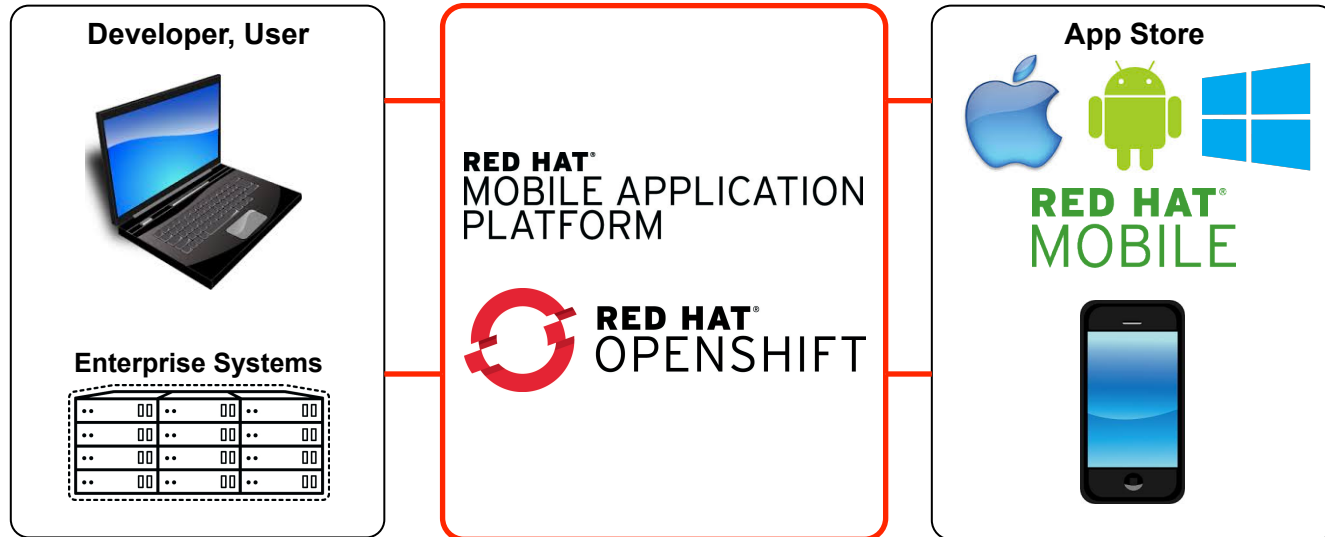

Mobile Context

Cloud Solutions

Enterprise Features

OpenShift

Enterprise Case Study



- Architecture
  - Modular, Resilient, Scalable, Disaster Recovery (Multi-AZ)
- Deployment Models
  - SaaS (Shared, Private, Dedicated Hosted), Hybrid, On-Premise
- Security
  - Enterprise Connectivity, VPC, Multi-MBaaS
- Hosted
  - No Installation, Optimized Configuration, Rapid Deployment

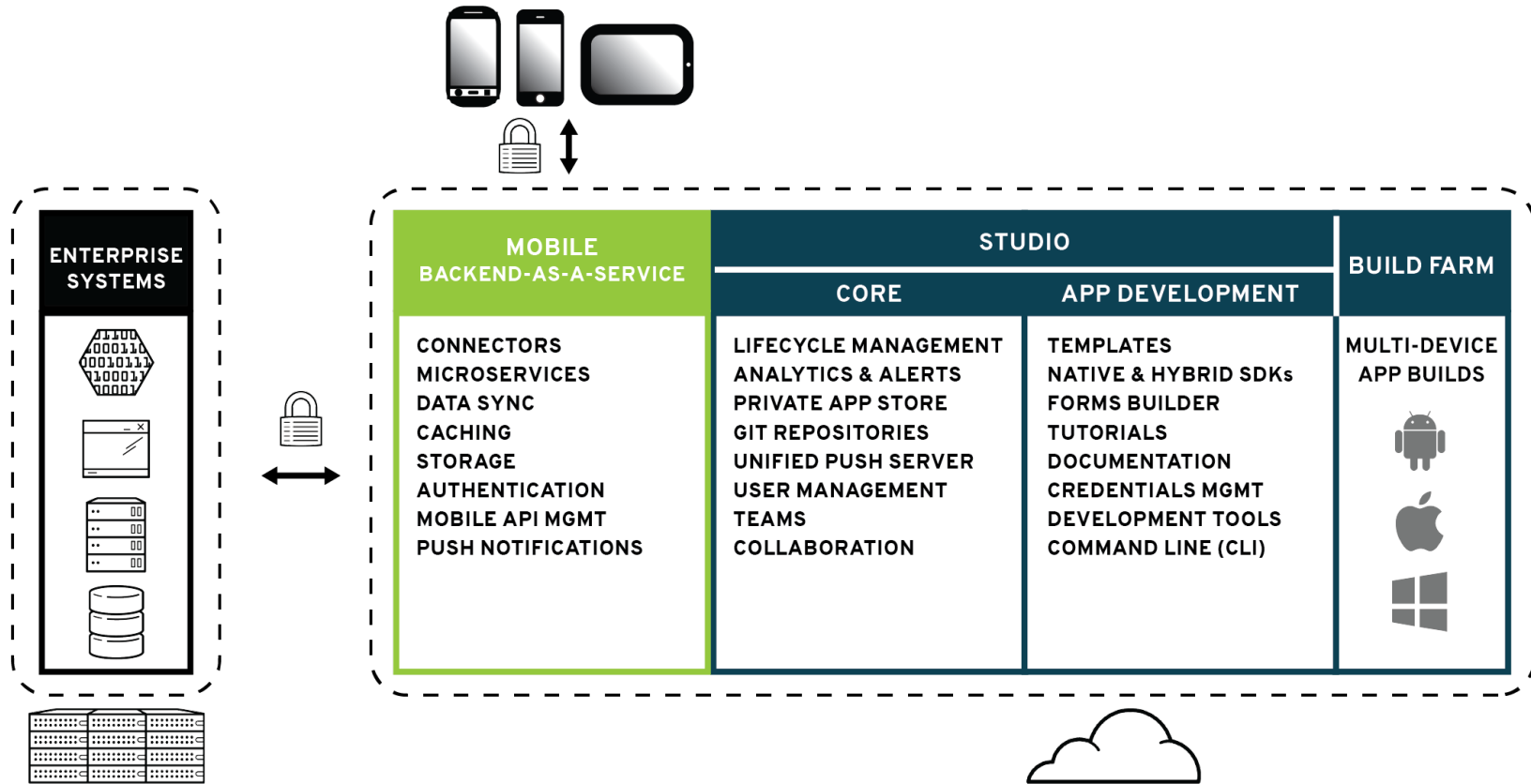



*Develop, Deploy, Manage*



*App Execution, Caching, Persistence, Services, Integration*

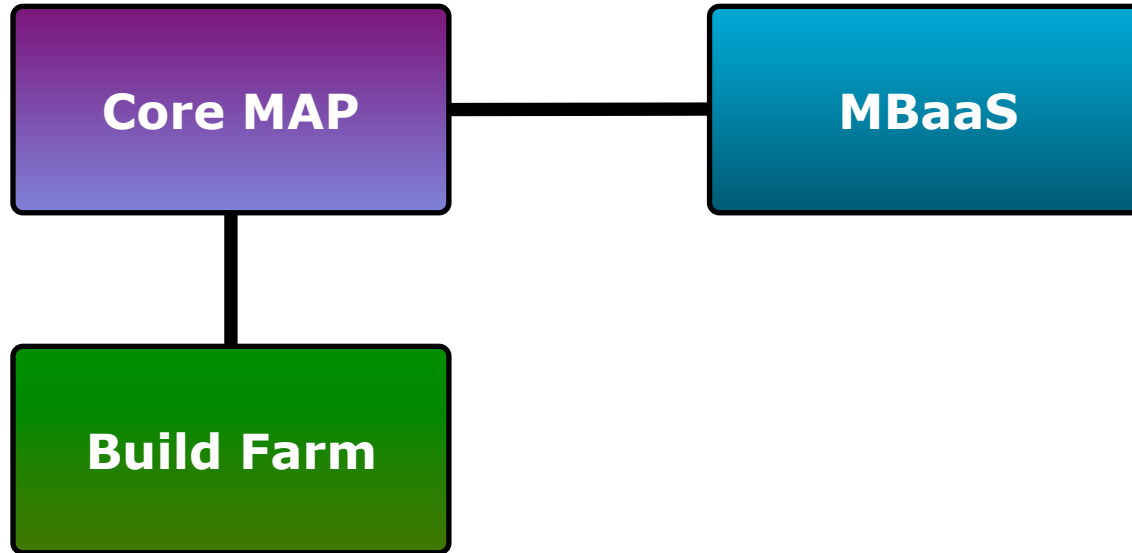

*Build Native & Hybrid, Cross-Platform Apps*

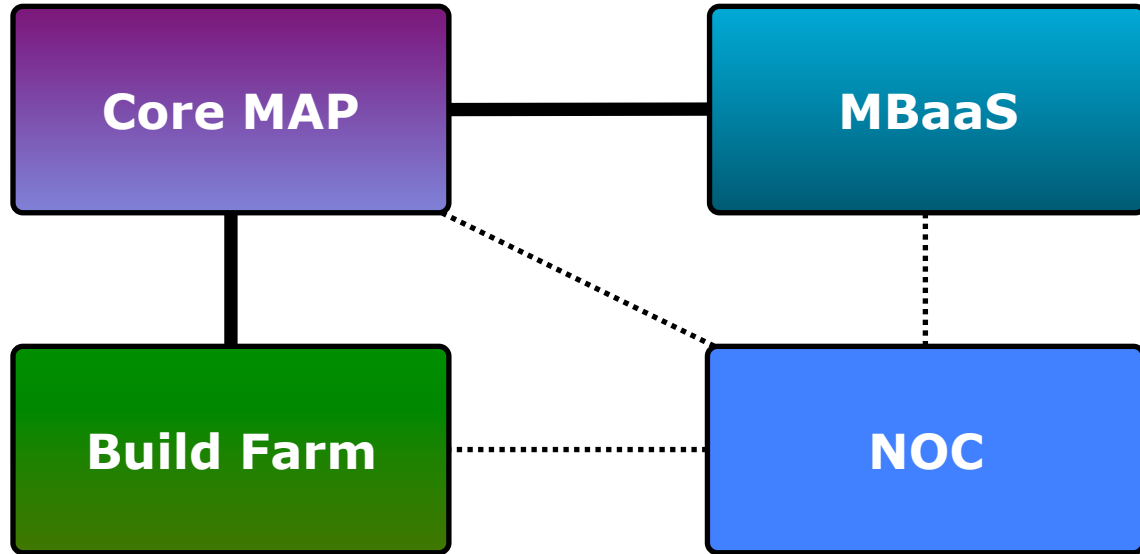

*Manage, Monitor, Access Control, Backups*

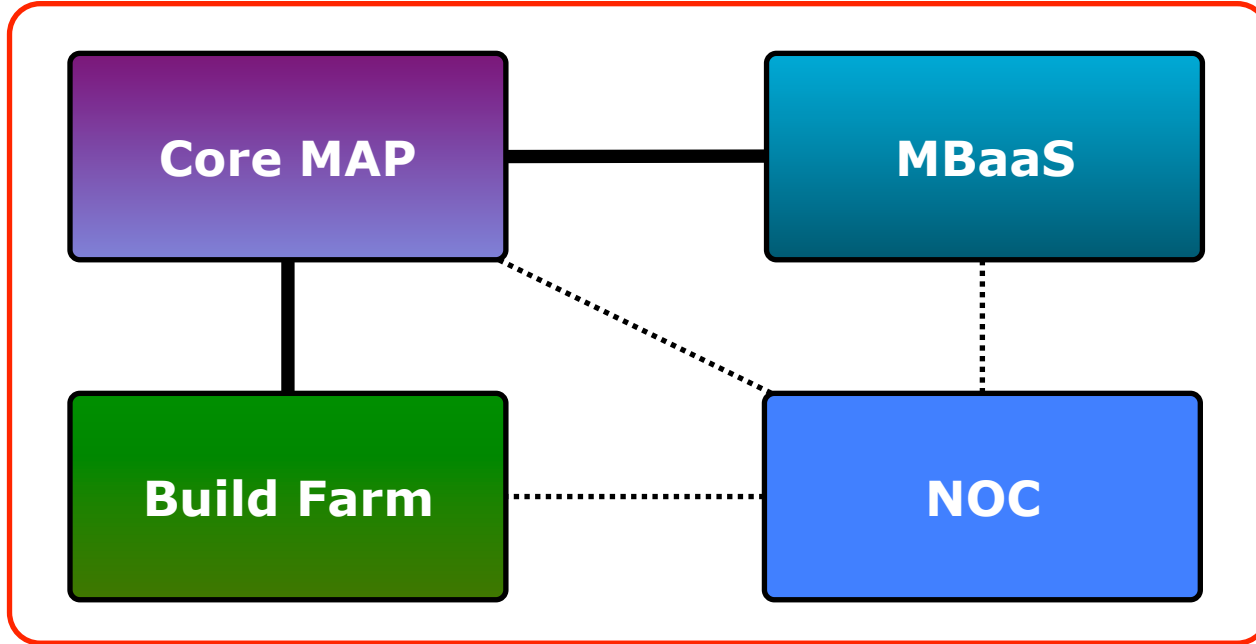

*Grid: Unique Geographic Region + Hosting Account*

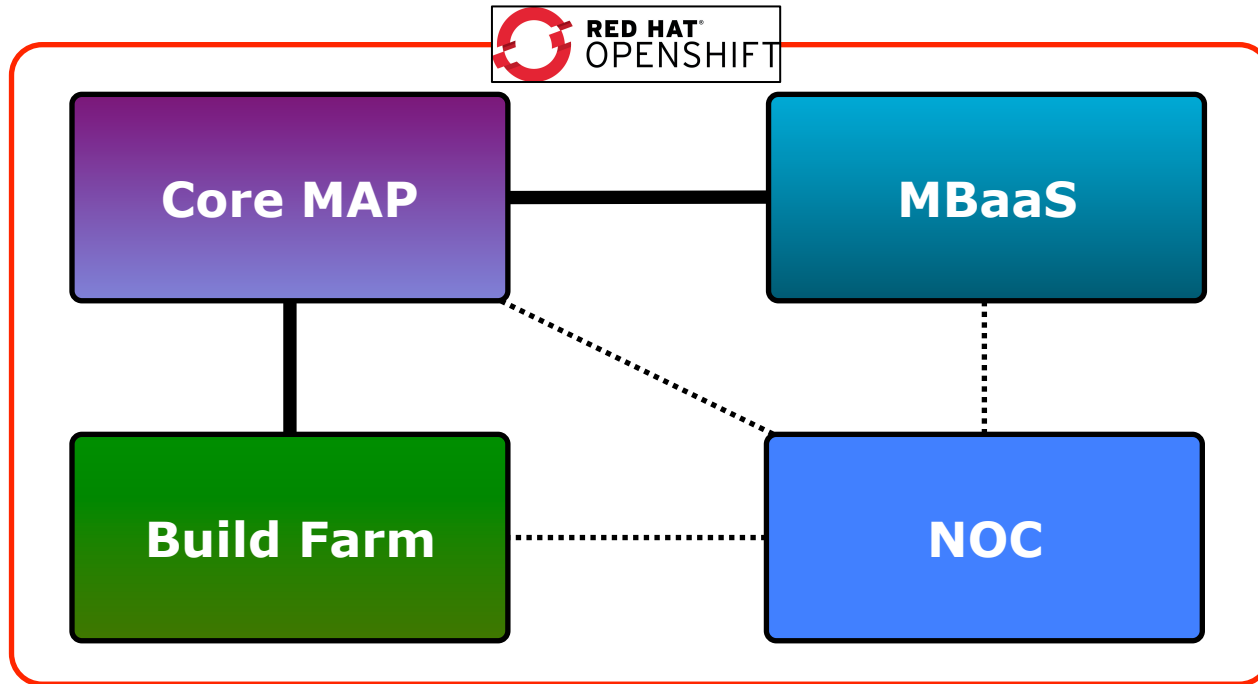



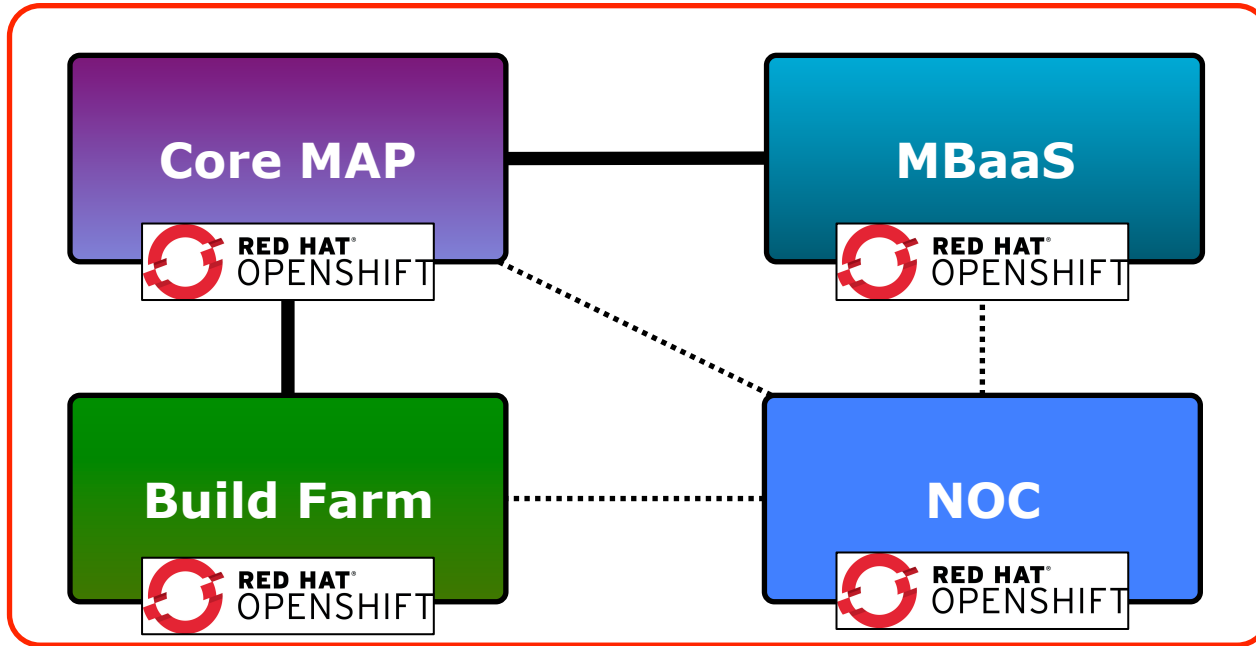

# *Topology Considerations*

**Core MAP**

**MBaaS**

**Build Farm**



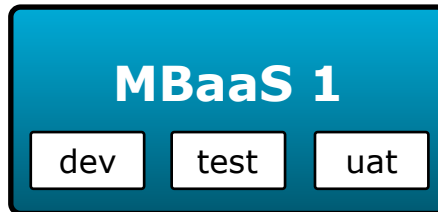

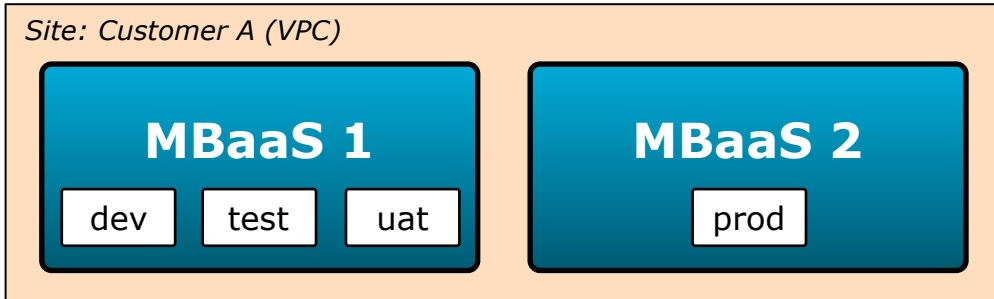

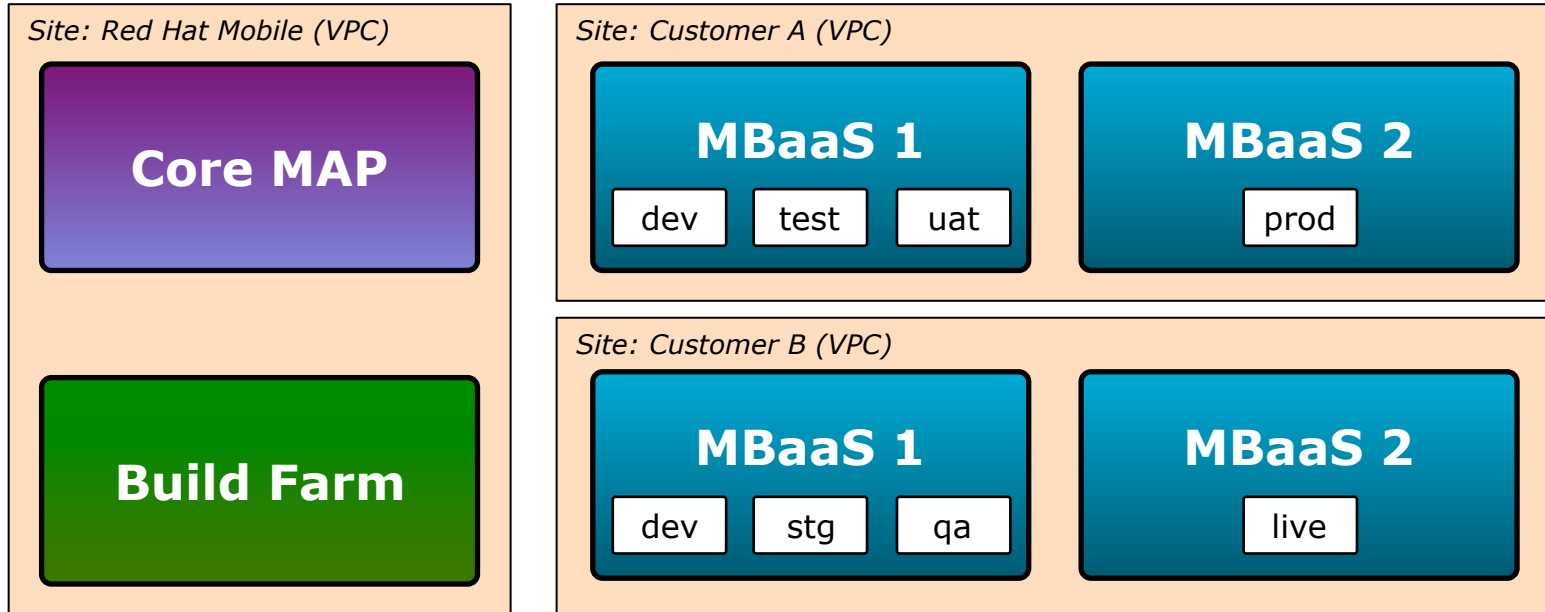

*Deployment Models*  
*and*  
*Enterprise Connectivity*



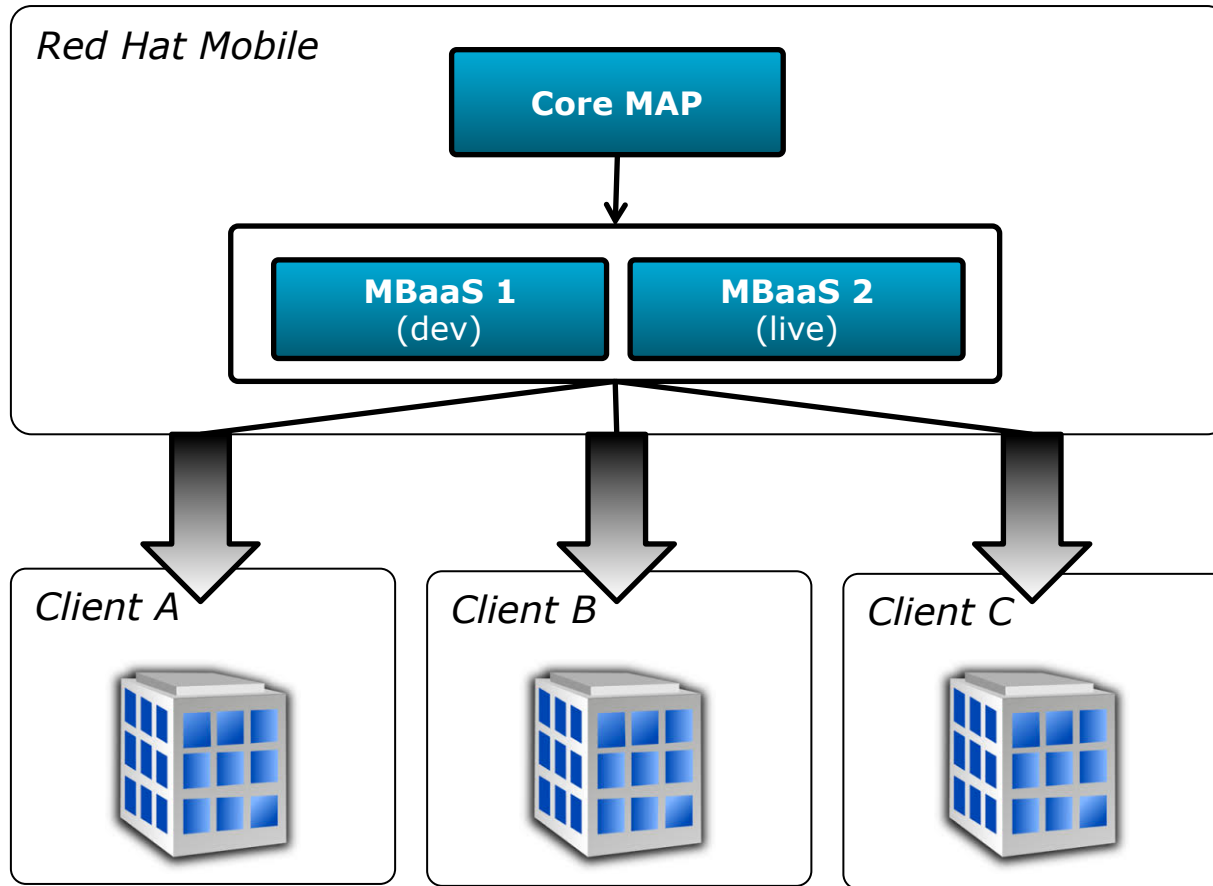

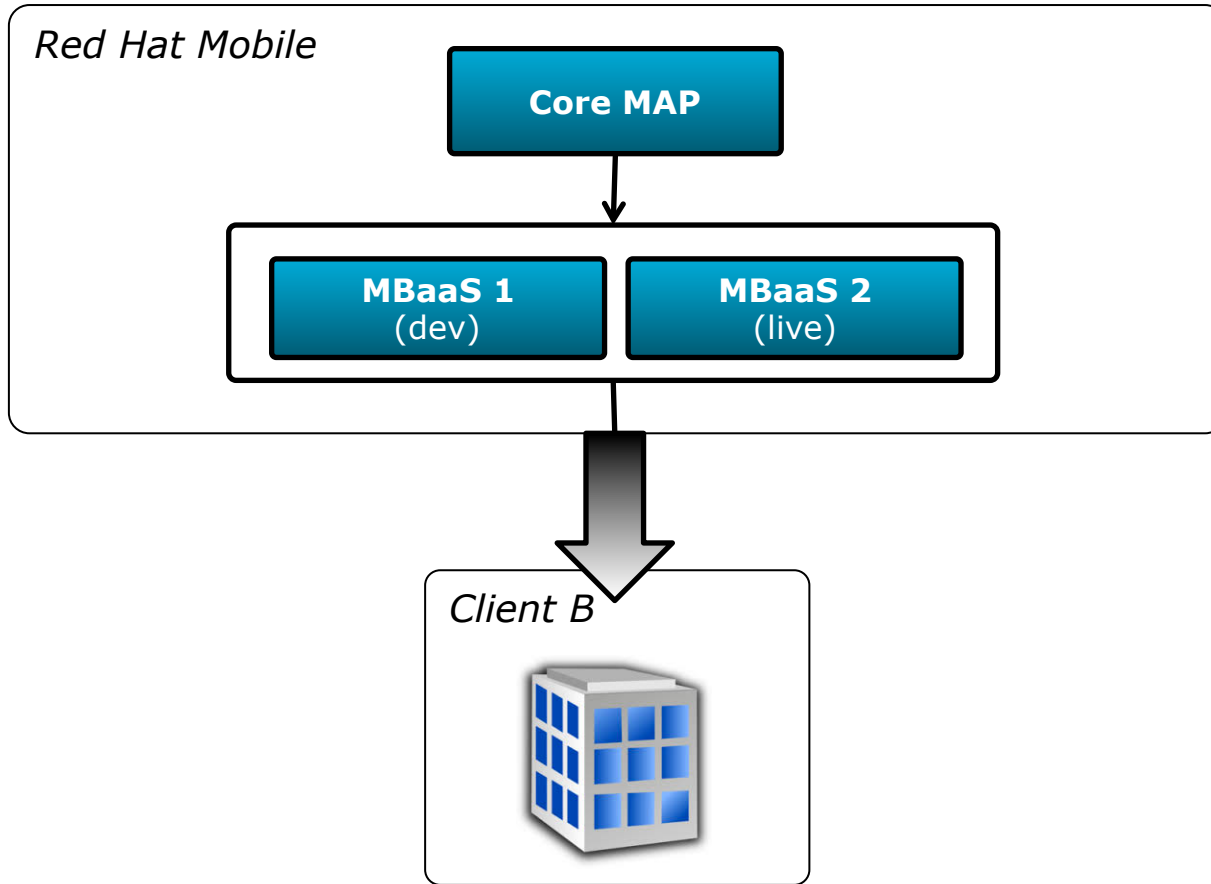

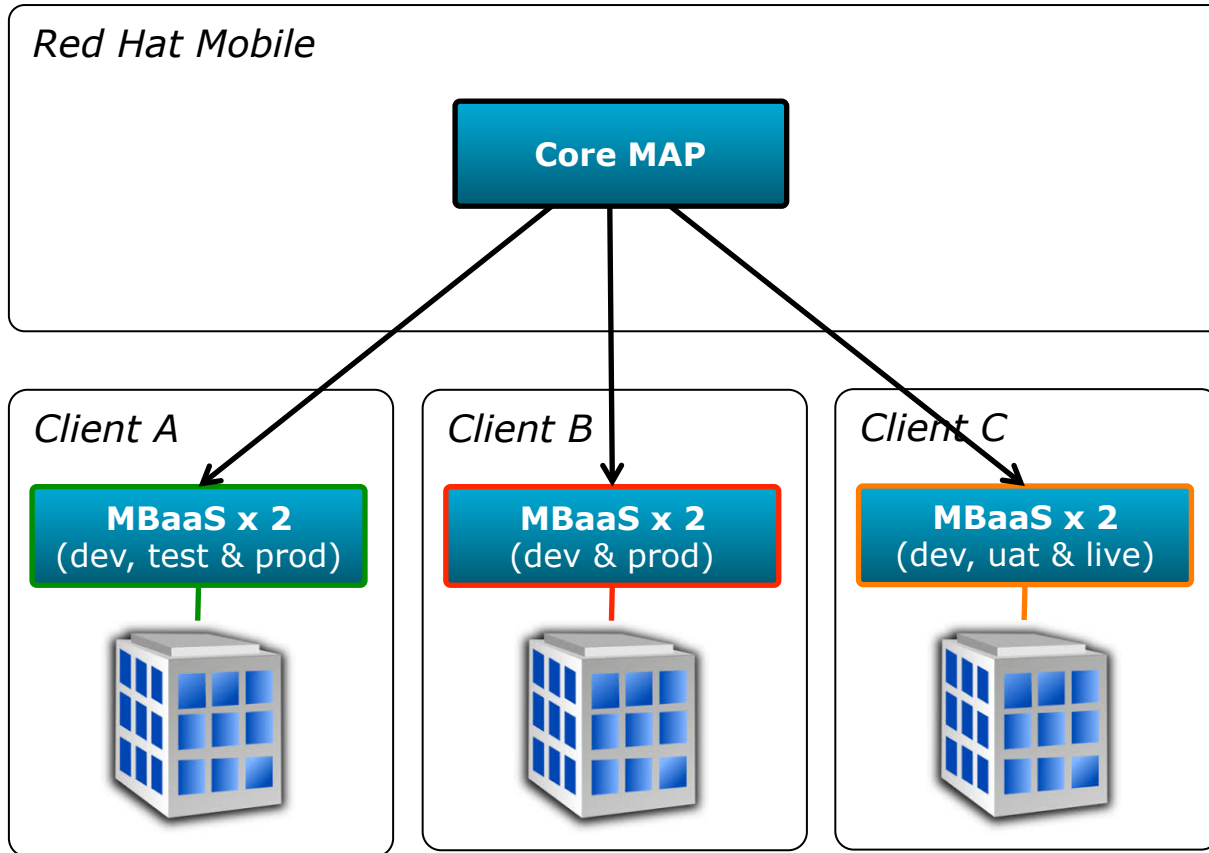

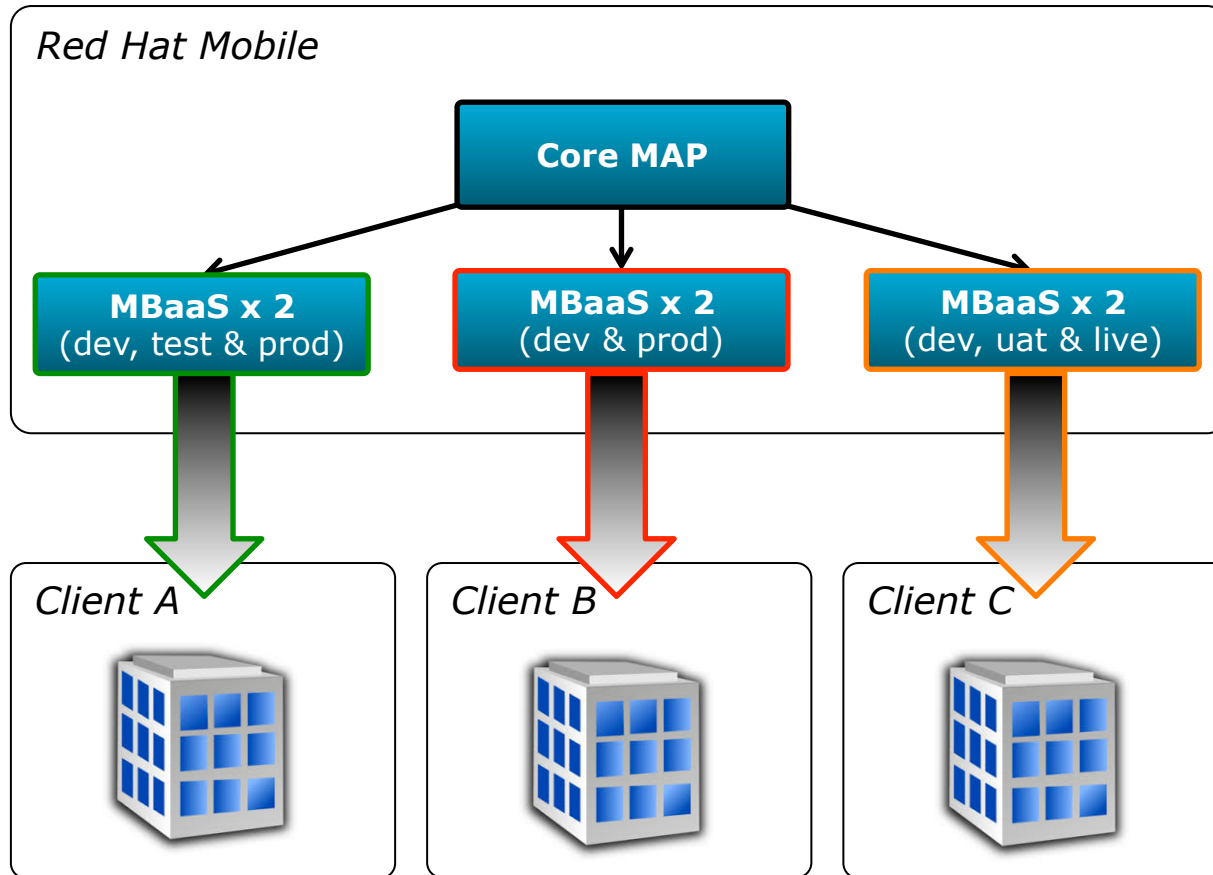

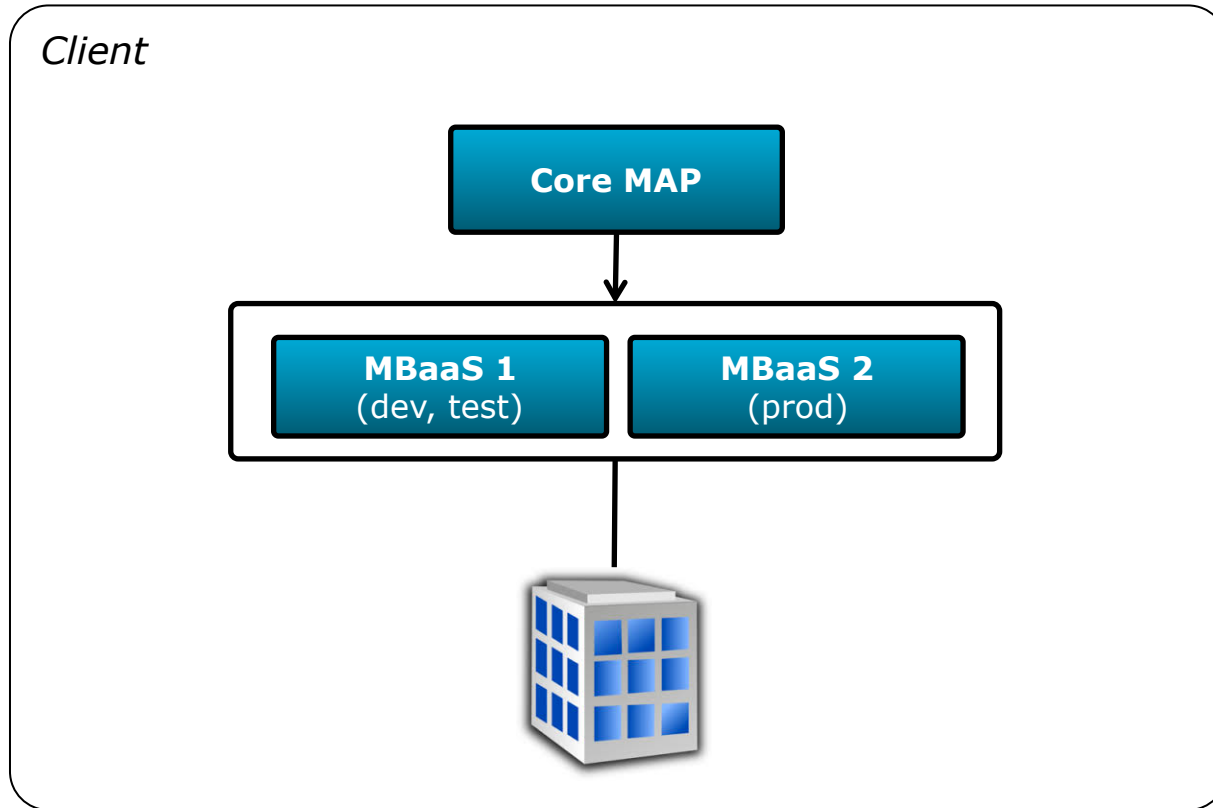

- *Public* (Open)
  - Publicly Addressable, Publicly Accessible
- *Restricted* (IP White-list, ACL)
  - Publicly Addressable, Privately Accessible
- *Private* (Site-to-Site VPN, VPC Peer)
  - Private Network, DMZ
  - VPC Peering (AWS)



Platform Context

Cloud Solutions

Enterprise Features

OpenShift

Enterprise Case Study

- Architecture
  - Multi-tenancy, Client Apps, Cloud Apps
- Security
  - Teams & Collaboration
- Enterprise
  - Lifecycle Management, MBaaS/Environment Services, Connectors
- RMAD
  - Workforce Management, Sync Framework (Offline First)



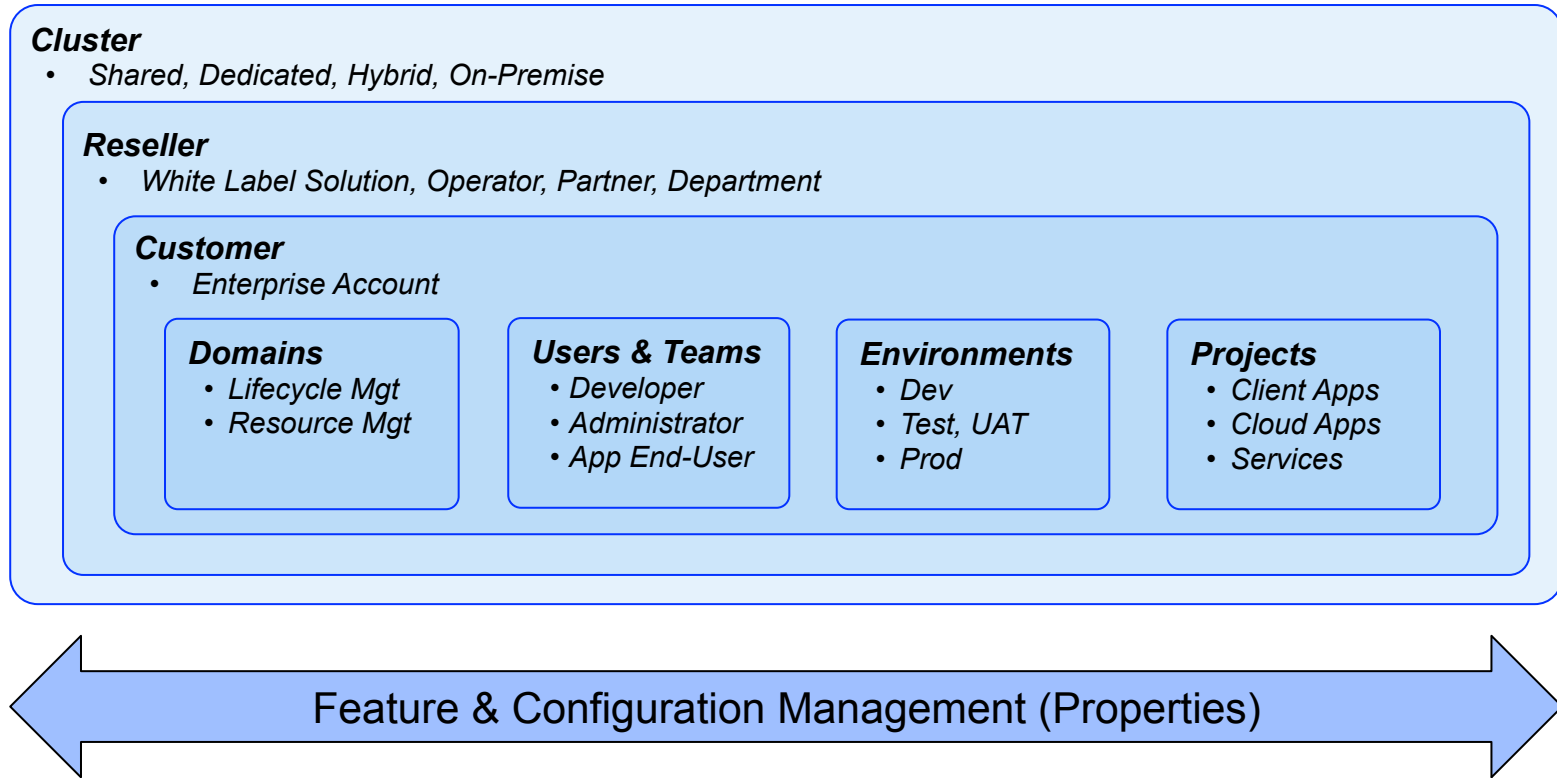

Permissions Tree		<a href="#">? Edit Permissions »</a>
Business Object	Permission Type	
▼ \$ Reseller	None	
▼ 👤 Customer	Edit	
▼ 🌐 Domain	Edit	
➤ ⚙️ Admin	Edit	
➤ ☁️ Services	Edit	
▼ 📊 Project	Edit	
☁️ Project Services	Edit	
☁️ Cloud Resources	Edit	

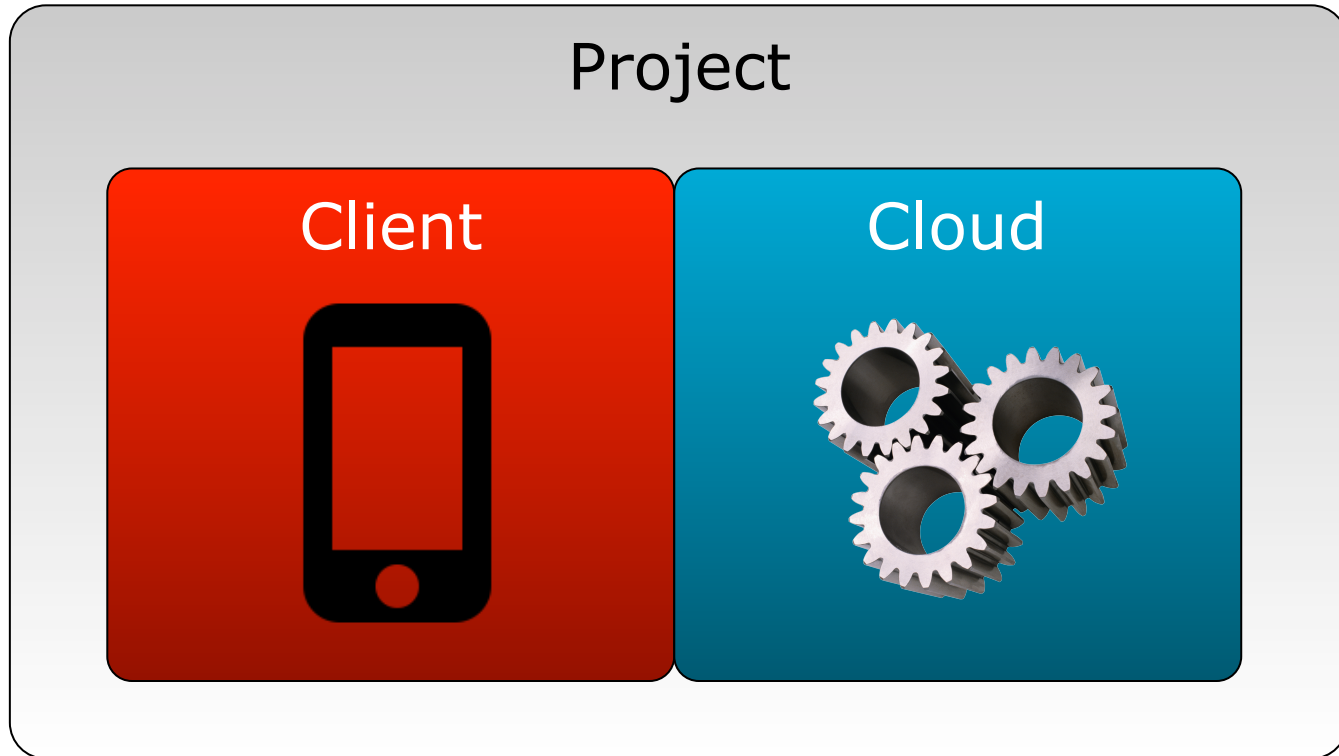



- ✓ Resource Planning
- ✓ Workorder Scheduling
- ✓ Dispatch workflow
- ✓ Real-time Updates
- ✓ Compliance Rules
- ✓ Workorder Completion
- ✓ Signature/Image Capture
- ✓ Reporting and Audit Trail



FEEDHENRY

**RAINCATCHER**

<http://feedhenry.org>

Platform Context

Cloud Solutions

Enterprise Mobility

**OpenShift**

Enterprise Case Study

## Red Hat Mobile Application Platform

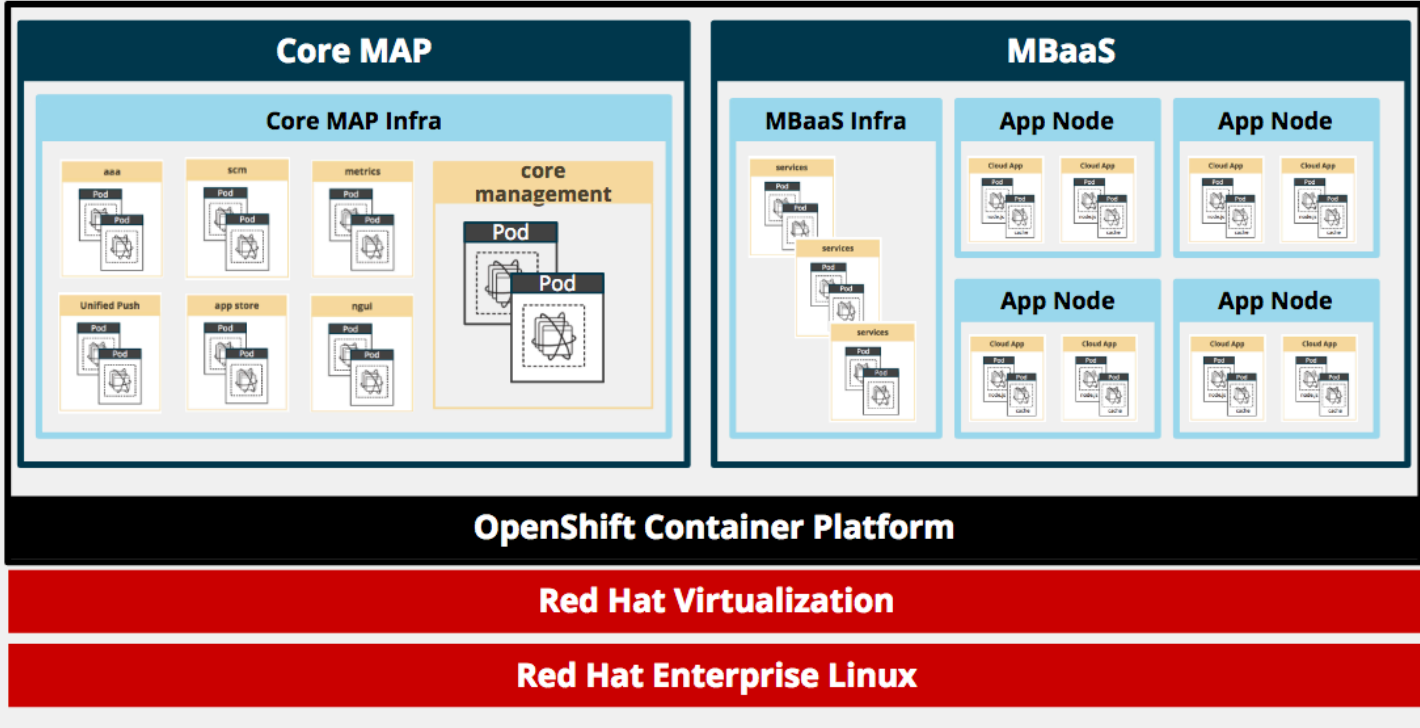

- Architecture
  - Resilience & Scalability (Kubernetes), Federation\* (DR)
- Security
  - Containerization (Docker), Network Isolation
- DevOps, Support
  - Resource Management, Monitoring, Aggregated Logging (ELK)
- CI/CD
  - Rolling Upgrades, Node Evacuation

Platform Context

Cloud Solutions

Enterprise Mobility

OpenShift

**Enterprise Case Study**



*site: xxx1*

*Core MAP*

<https://acme.us.feedhenry.com>  
*xxx1-core*

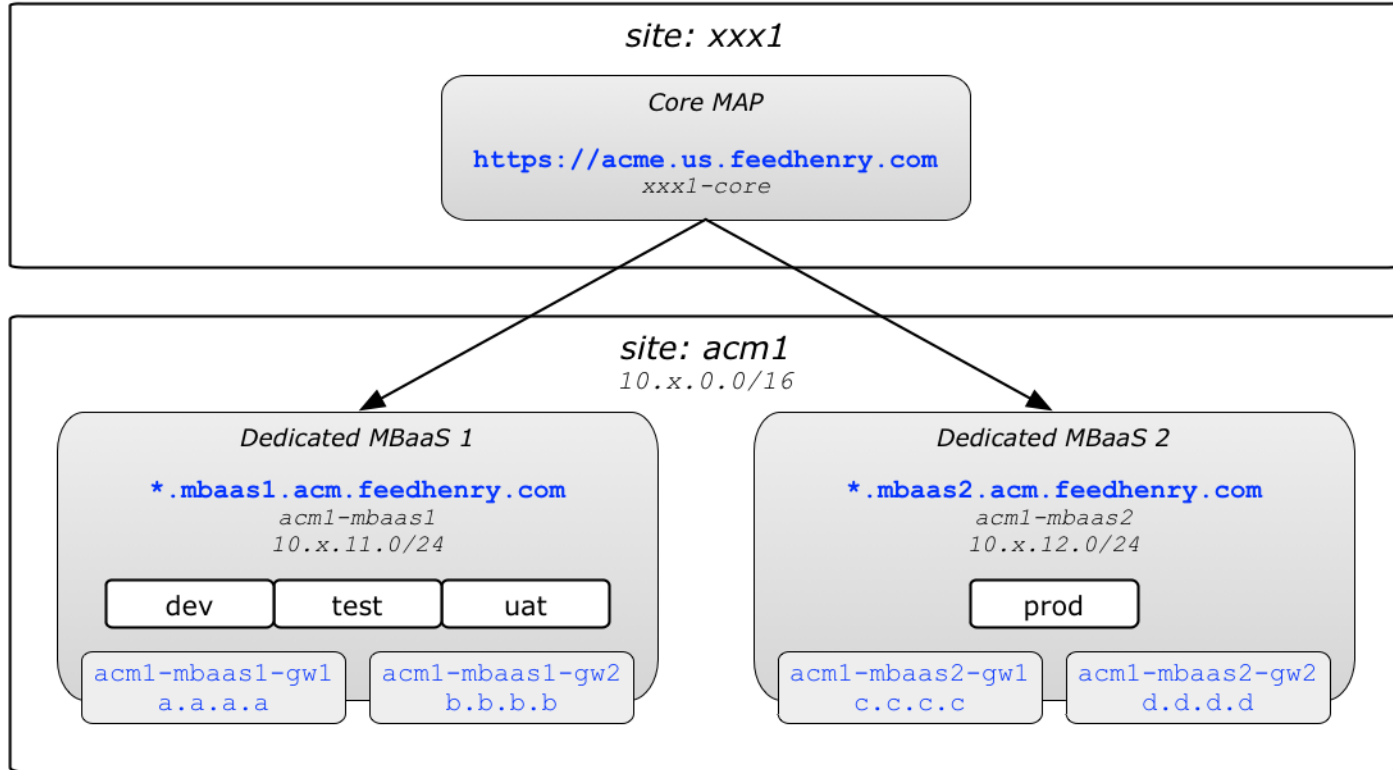

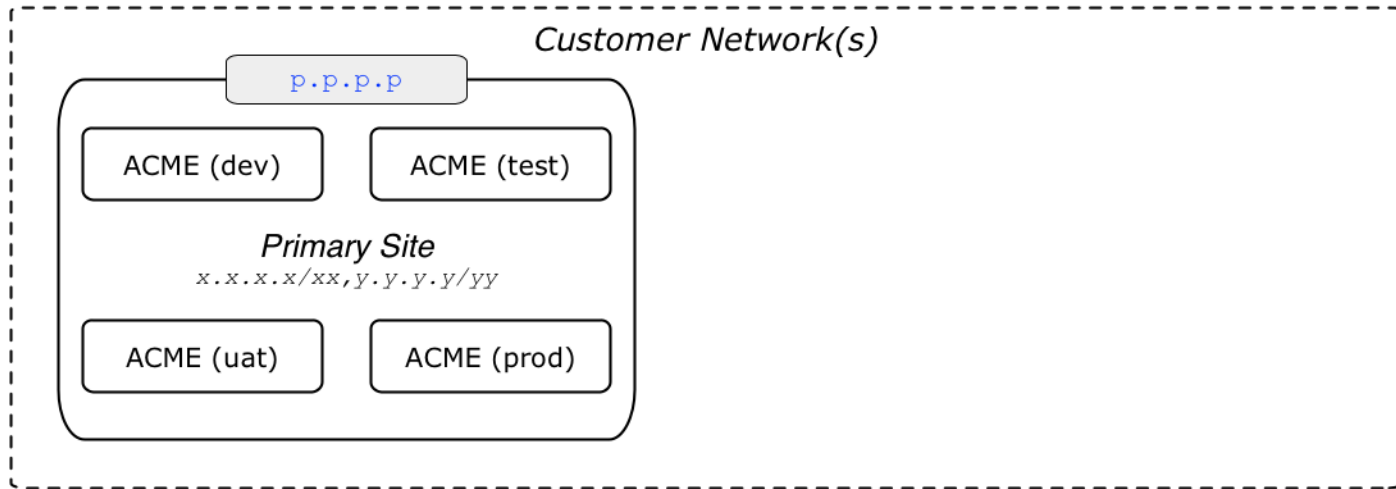

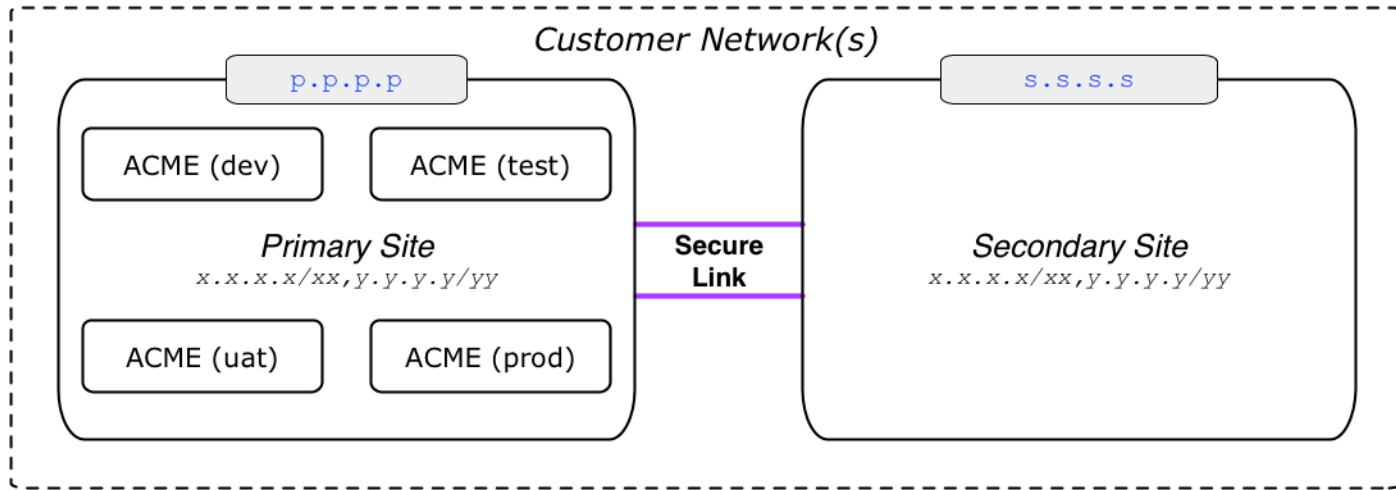

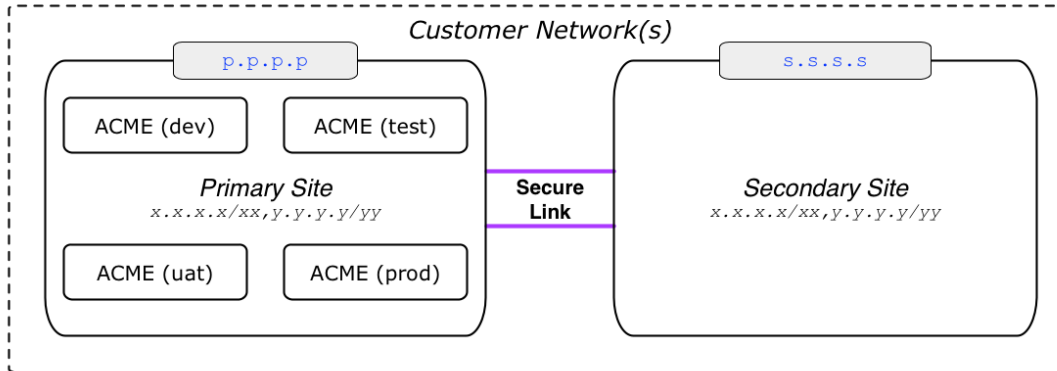
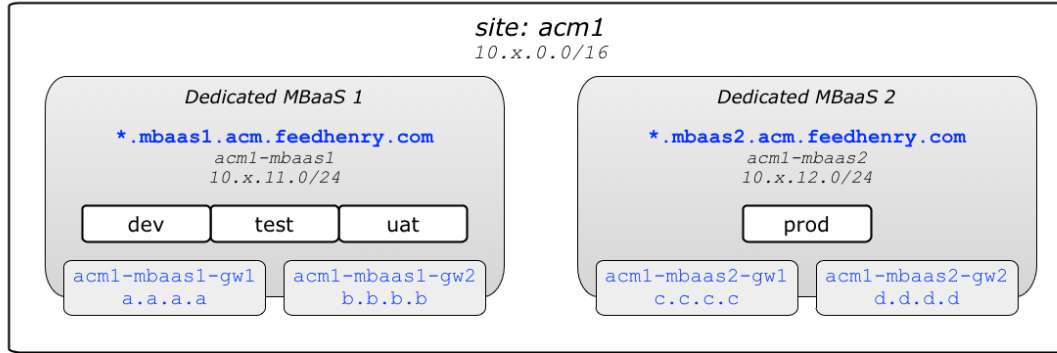

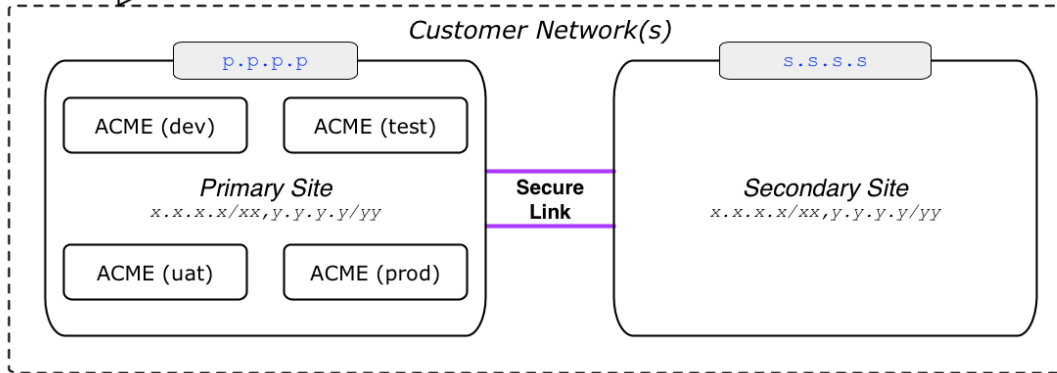
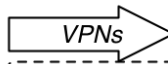
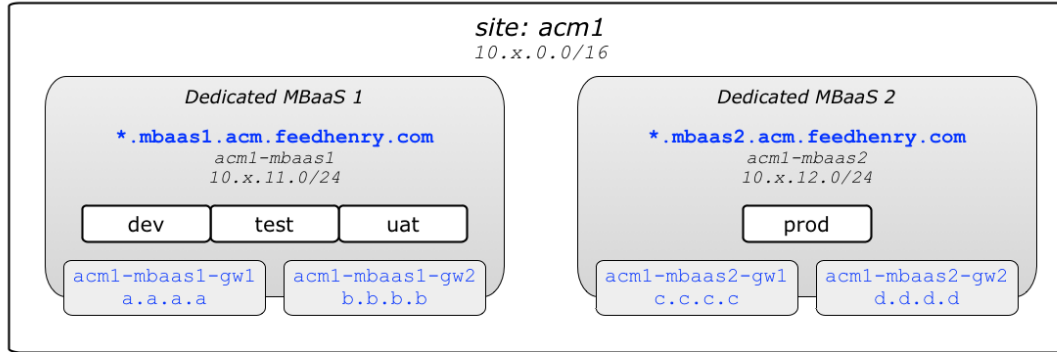

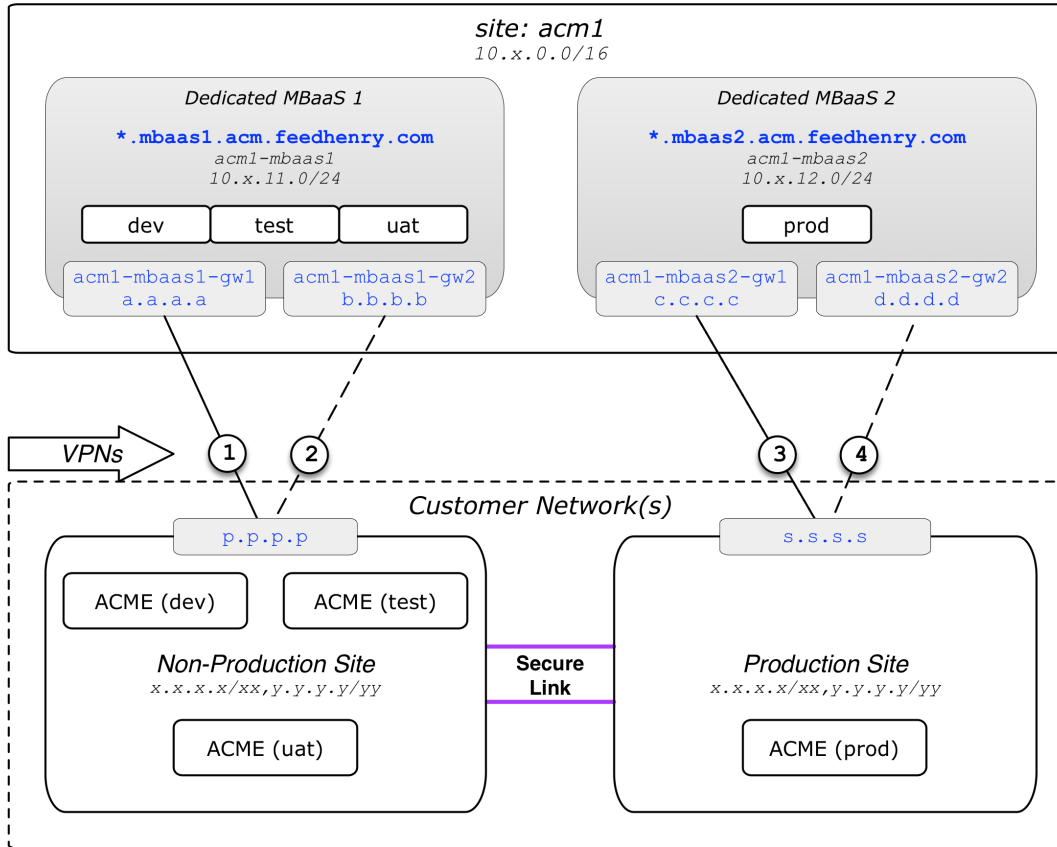

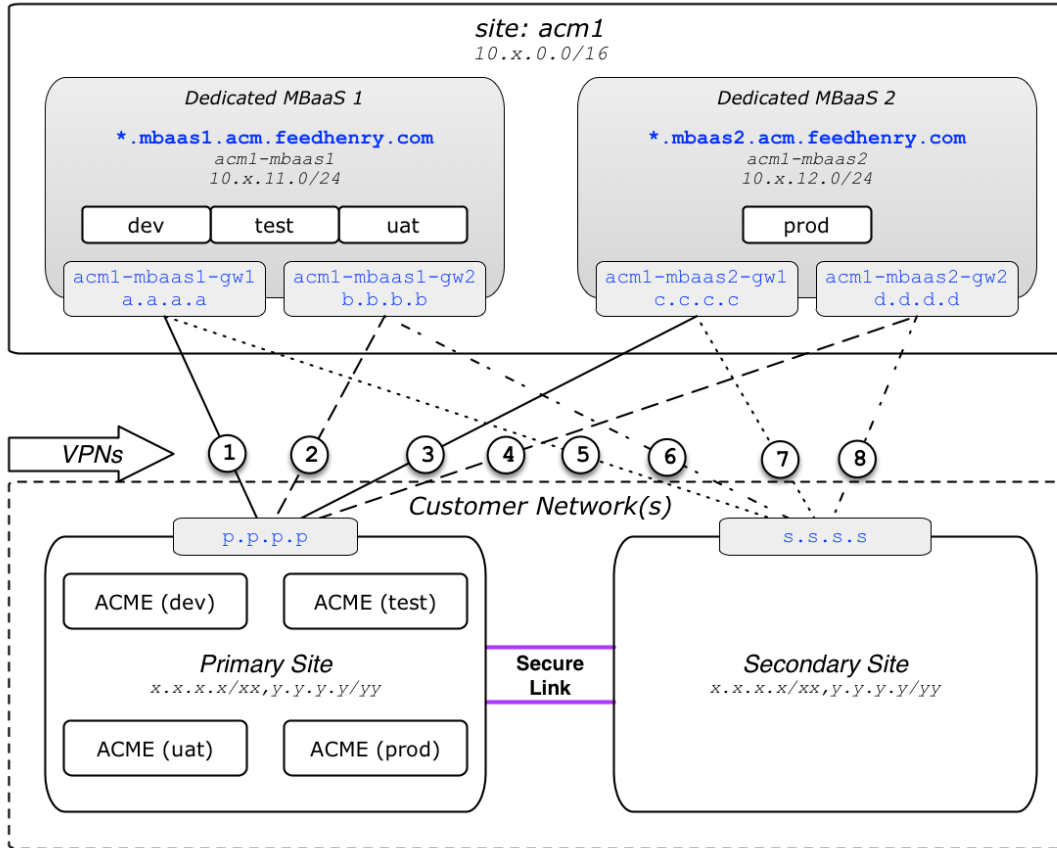



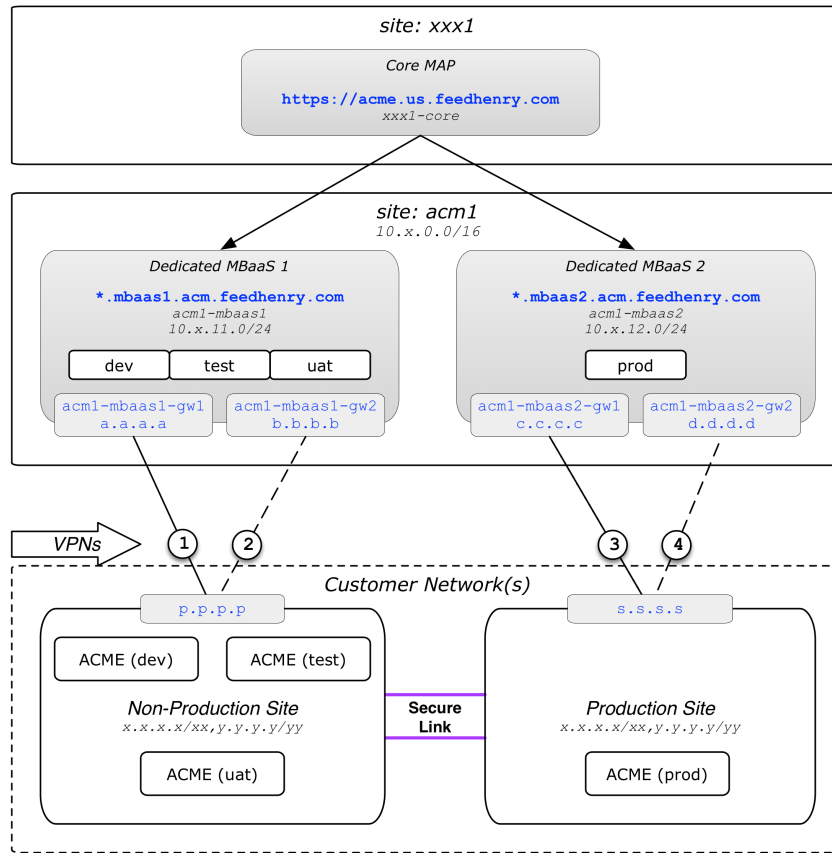

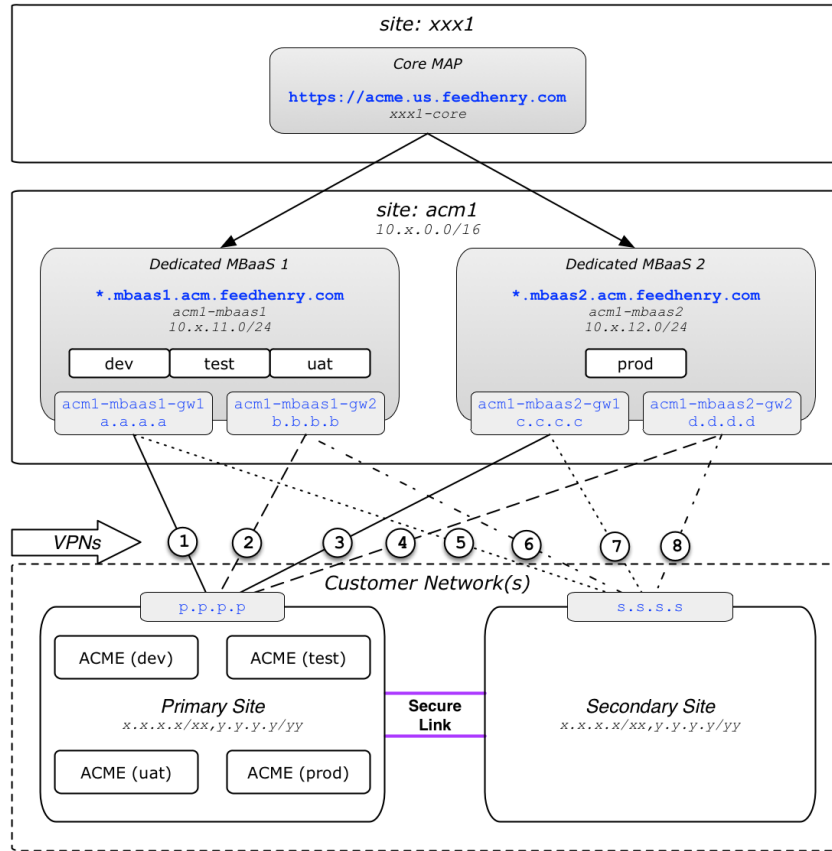

# RED HAT SUMMIT

LEARN. NETWORK.  
EXPERIENCE  
OPEN SOURCE.

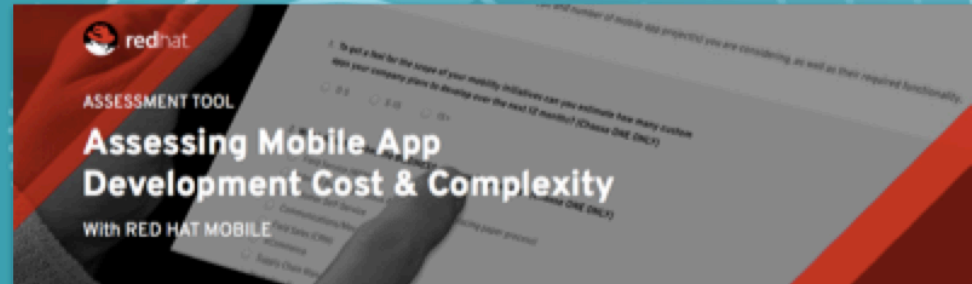

Discover the costs and complexity of  
mobile app development using our

**MOBILE ASSESSMENT TOOL**

**<http://mobiledevcosts.com>**

# RED HAT® MOBILE

James Mernin

CTO, Red Hat Mobile

[jmernin@redhat.com](mailto:jmernin@redhat.com)

+353 51 810120

@mernin | @redhatmobile

<http://redhat.com/mobile>