

# Painting objects with Mondrian

Michael Meyer and Tudor Gîrba

Software Composition Group  
University of Berne  
Switzerland

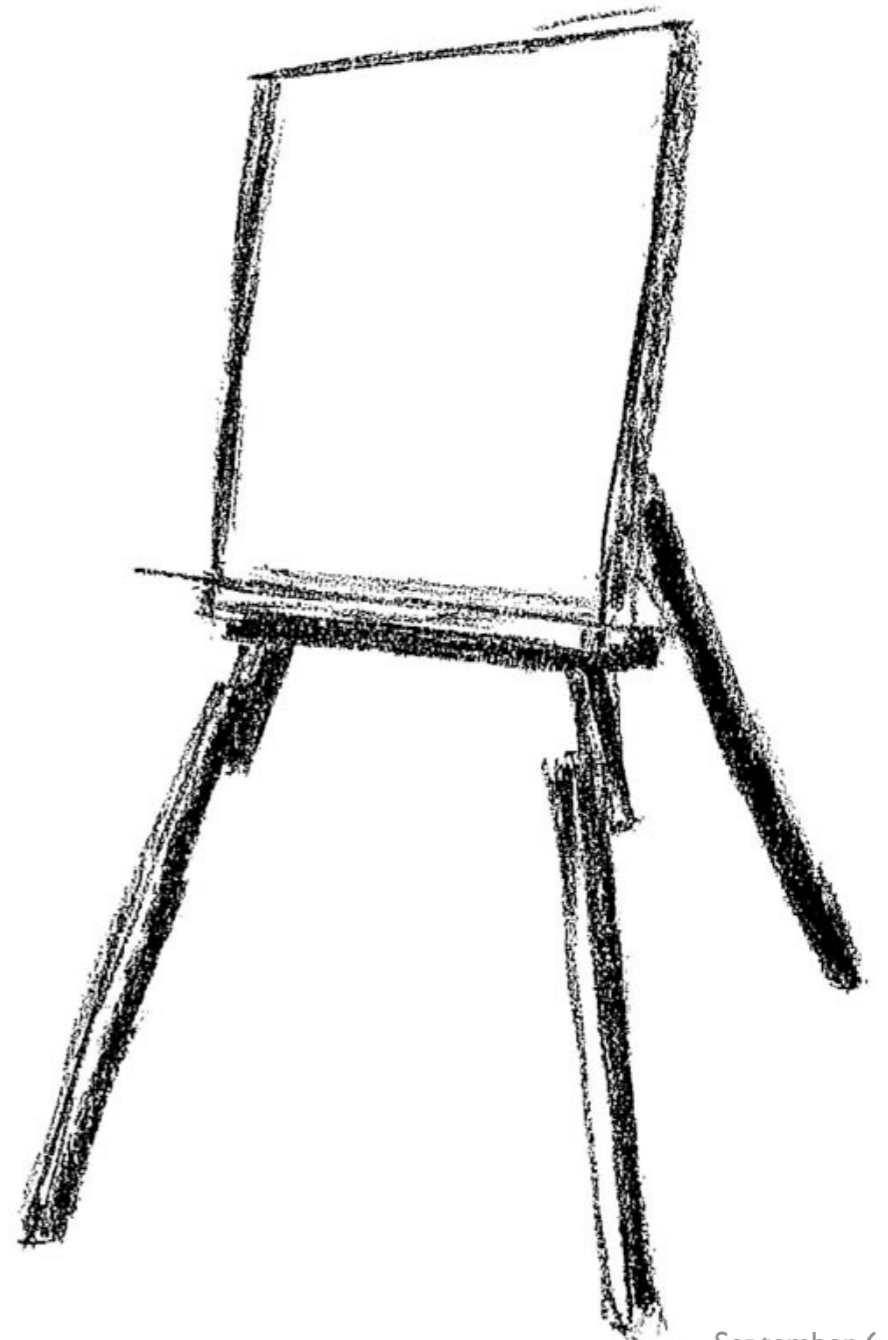

**Mondrian is about visualization**

**Mondrian is also about interaction**

**please ask questions**

**Why visualization?**

**“One picture is worth a thousand words”**

G3ae Schema  
 Namespace: G3ae  
 vers. 1.0 - 24/08/2002

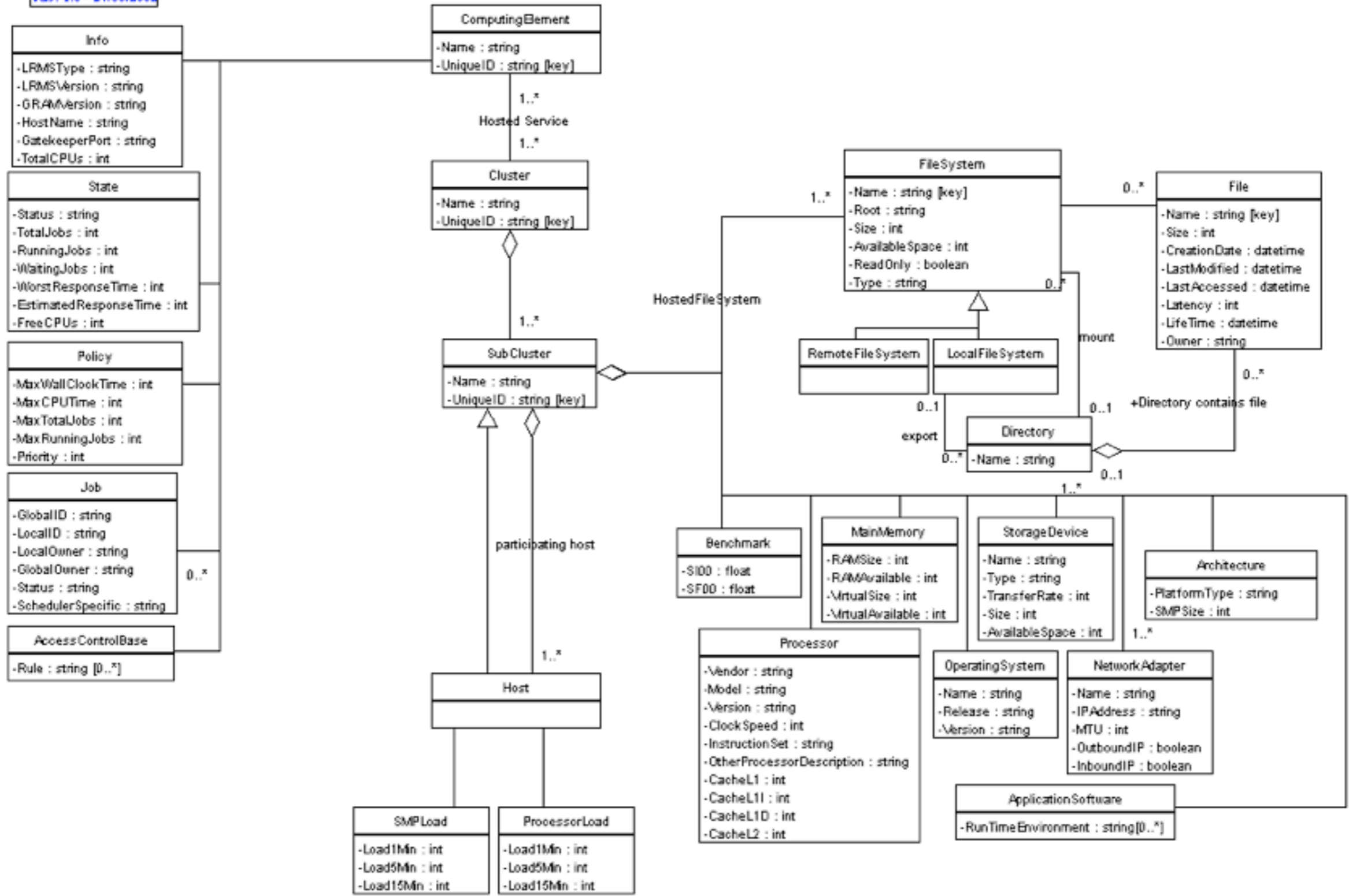





# 70% of our sensors are dedicated to vision

Do you see?

Picture it!

Let's see

I see



**How many groups do you see?**

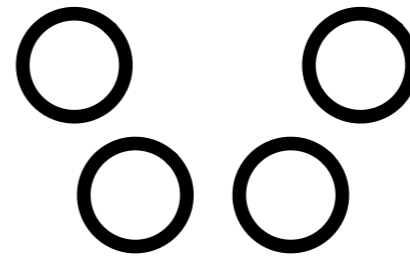
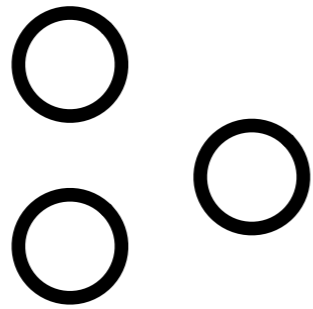

**How many groups do you see?**

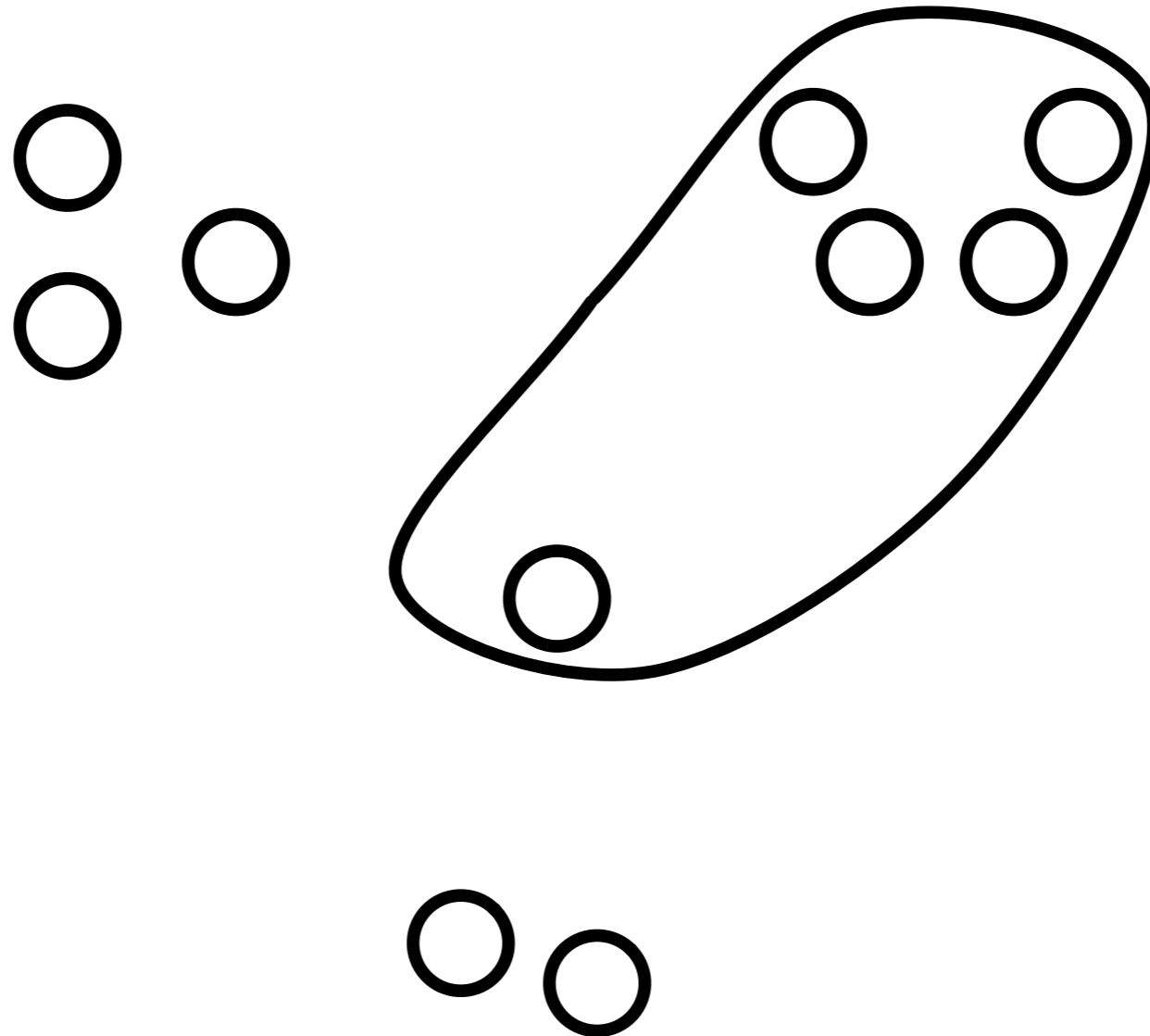

**How many groups do you see?**

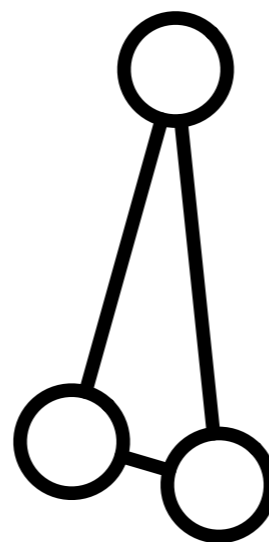
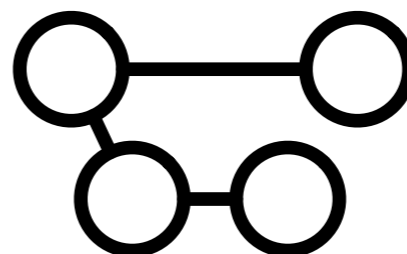
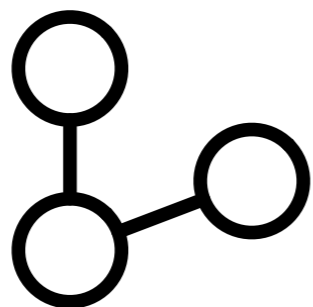

**How many groups do you see?**

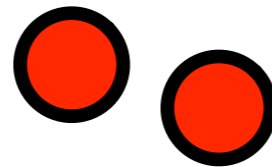
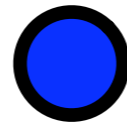
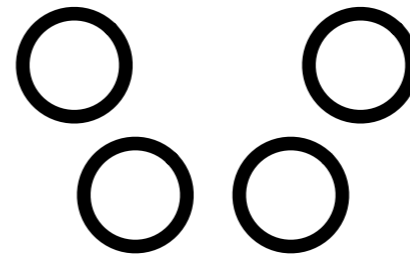
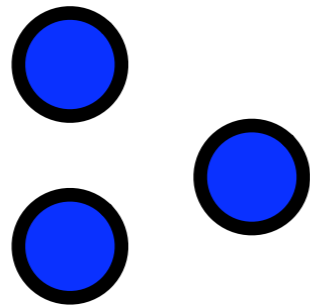

# 70% of our sensors are dedicated to vision

Do you see?

Picture it!

Let's see

I see



**“One picture is worth a thousand words”**

**Example: What is**

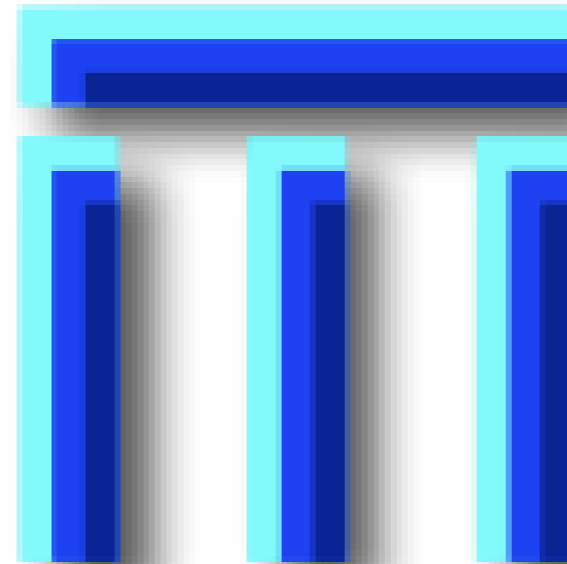

**?**



absent absolute abstract accept access accessed accesses accessing accessor action actions add added addressee anchor annotate annotated applied  
argument arguments aspect assignment association attribute attributes authors auto average bar base based basic behaviour behavioural belongs big  
binding bindings block blueprint body boolean born browse browser build bundle bundles button bytes cache cancel candidate candidates cascade  
categories category cdif cf change changed characters chart check child children class classes clear clones close code cohesion collect collection  
column comment comments compilation complete complex complexity computable compute computed condition conditionals const constructor content  
contents context control correct correlation count counter create current cvs cyclomatic data dataset dead declared deep default defined defining  
definition dependencies dependents description descriptions descriptor destination detect deviation dictionary difference direct dirty display distinct distribution  
drag duplicated duplication duplications earliest edit editor empty encoding ensure entities entity equals error evolution exists explicit export expression  
expressions extended external extract extracted factor famix favorites feedback field file filed files filter fixed folder folders formal fragments full  
function fuziness fuzzy global god grid group grouped groups handle hierarchy high higher historical histories history home icon id implementation  
implicit import importer importing include included includes including incoming increase index information inheritance inheritances inherited inherits initialize  
inject inspector inst install instance int interesting interface internal internally intersect invocation invocations invoke invoked invokes items java jsp  
kill kinds label lan language late latest left length level lines list literal local log lonely long make map mask matches matrix max maximum measure  
menu message meta metaclass metamodel method methods metric model models mof mondrian moose moosify mse multiplications multiplier named  
names namespace namespaces navigation needed nesting nil node number object occurrence occurrences omit open operate operation operator optimize  
originate originator outgoing output overridden package packaged packages panel parameter parameters paranthesis parcel parcels parent parser part  
percent position positional post pragma pre prec present pressed primitive print prior private process progress properties property protected public  
pure put qualifier question read receiver receiving recursive recursively reduce reference registry reify reject related remove removed replace request  
reset return root satisfy save scan scanner scope section select selected selector selectors send sends separator sequence server service set shape  
short signature signatures silent simple size smalltalk sole sort sorting source space spaces spec splice squeak st stability start state statements  
store strange strategy stream string structural stub subcanvas subclass subclasses subsection suffix sum super superclass superclasses suplimentary  
symbol system table tabs tag targets tcc temporaries text threshold token tool total treating tree type types ui uml understand uninitialized union  
unique unknown unnamed update uuid values var variable variables version versions view viewer widget window write xmetamodel xmi

absent absolute abstract **accept** **access** accessed accesses accessing accessor action actions **add** added addressee **anchor** annotate annotated applied argument  
arguments aspect assignment association **attribute** attributes authors auto average bar base based basic behaviour behavioural **belongs** big binding bindings block **blueprint**  
body boolean born browse **browser** **build** bundle bundles button bytes cache cancel candidate candidates cascade categories **category** cdif cf change changed characters  
**class** classes clear clones close code cohesion collect collection column **comment** comments compilation complete complex  
chart check child children **compute** computed condition conditionals const constructor **content** contents context control correct correlation count counter **create** current cvs  
cyclomatic data dataset dead declared deep **default** defined defining definition dependencies dependents **description** descriptions descriptor destination **detect** deviation dictionary  
difference direct dirty display distinct distribution drag duplicated **duplication** duplications earliest edit editor empty encoding **ensure** entities **entity** equals error evolution  
exists **explicit** export **expression** expressions extended external extract extracted factor **famix** **favorites** feedback field **file** filed **files** filter fixed folder folders  
formal fragments full function fuziness fuzzy global god grid **group** grouped groups handle hierarchy high higher historical histories **history** home icon id implementation  
implicit **import** importer importing include included includes including incoming increase index information inheritance inheritances inherited inherits **initialize**  
inject inspector inst install instance int interesting **interface** **internal** internally intersect invocation invocations invoke invoked invokes items java jsp kill kinds label lan  
language late latest left length level lines **list** literal local log lonely **long** make map mask matches matrix max maximum measure menu **message** meta metaclass **metamodel**  
**method** methods metric **model** models mof mondrian **moose** moosify mse multiplications multiplier **named** names namespace namespaces  
navigation needed nesting nil node **number** object occurrence **occurrences** omit **open** operate operation operator **optimize** originate originator outgoing output  
overriden **package** packaged packages panel parameter parameters **paranthesis** parcel parcels **parent** parser part percent **position** positional post pragma **pre** prec present  
pressed primitive **print** prior private process progress **properties** **property** protected public pure put qualifier question read receiver receiving **recursive** recursively  
reduce **reference** registry **reify** reject related **remove** removed replace request reset return root satisfy **save** scan scanner **scope** section **select** selected selector  
selectors send sends separator sequence server service **set** shape short signature signatures silent simple size smalltalk sole sort sorting **source** space spaces spec  
splice squeak st stability start state statements store strange strategy stream **string** structural **stub** subcanvas subclass subclasses subsection suffix sum super superclass superclasses  
suplimentary symbol **system** table tabs tag targets tcc temporaries text **threshold** token tool total treating tree **type** types **ui** uml understand uninitialized union **unique** unknown  
unnamed update uuid values var **variable** variables **version** versions **view** viewer widget window write xmetamodel xmi

absent absolute abstract accept **access** accessed accesses accessing accessor action actions **add** added addressee anchor annotate annotated applied argument  
arguments aspect assignment association **attribute** attributes authors auto average bar base based basic behaviour behavioural **belongs** big binding bindings block blueprint  
body boolean born browse browser **build** bundle bundles button bytes cache cancel candidate candidates cascade categories **category** cdif cf change changed characters  
**class** classes clear clones close code cohesion collect collection column comment comments compilation complete complex  
chart check child children **compute** computed condition conditionals const constructor **content** contents context control correct correlation count counter **create** current cvs  
cyclomatic data dataset dead declared deep **default** defined defining definition dependencies dependents **description** descriptions descriptor destination **detect** deviation dictionary  
difference direct dirty display distinct distribution drag duplicated **duplication** duplications earliest edit editor empty encoding ensure entities **entity** equals error evolution  
exists explicit export **expression** expressions extended external extract extracted factor **famix** favorites feedback field **file** filed files filter fixed folder folders  
formal fragments full function fuziness fuzzy global god grid **group** grouped groups handle hierarchy high higher historical histories **history** home icon id implementation  
implicit **import** importer importing include included includes including incoming increase index information inheritance inheritances inherited inherits **initialize**  
inject inspector inst install instance int interesting **interface** internal internally intersect invocation invocations invoke invoked invokes items java jsp kill kinds label lan  
language late latest left length level lines **list** literal local log lonely long make map mask matches matrix max maximum measure menu message meta metaclass **metamodel**  
**method** methods metric **model** models mof mondrian **moose** moosify mse multiplications multiplier **named** names namespace namespaces  
**number** navigation needed nesting nil node object occurrence **occurrences** omit **open** operate operation operator **optimize** originate originator outgoing output  
overriden **package** packaged packages panel parameter parameters paranthesis parcel parcels **parent** parser part percent position positional post pragma **pre** prec present  
pressed primitive print prior private process progress properties **property** protected public pure put qualifier question read receiver receiving recursive recursively  
**reference** registry reify reject related **remove** removed replace request reset return root satisfy **save** scan scanner **scope** section **select** selected selector  
selectors send sends separator sequence server service **set** shape short signature signatures silent simple size smalltalk sole sort sorting **source** space spaces spec  
splice squeak st stability start state statements store strange strategy stream **string** structural stub subcanvas subclass subclasses subsection suffix sum super superclass superclasses  
suplimentary symbol **system** table tabs tag targets tcc temporaries text threshold token tool total treating tree **type** types ui uml understand uninitialized union **unique** unknown  
unnamed update uuid values var **variable** variables **version** versions **view** viewer widget window write xmetamodel xmi



**class** named number import model reference version classes  
method moose metamodel entity group add unique property initialize variable  
compute expression set optimize view select history access list belongs methods importing  
meta icon string interface default scope namespace menu source file famix attribute type stub package  
description save comment ensure pre open declared defined create print accessed build inheritance attributes evolution  
code local index block category accesses signatures threshold node extended boolean lines invocations spec signature  
window basic complexity candidate empty global smalltalk display histories column remove parameter qualifier folder  
control formal invocation label abstract simple collection system receiver hierarchy protected var entities importer born  
superclass receiving reduce selector selected packaged private data mask mse argument changed text dependents implicit body  
names pragma arguments action packages log filed post average statements incoming present versions encoding invoked context  
comments public prior full collect outgoing max subclass super annotate fuziness progress export level occurrences favorites  
accept clear message position recursive internal properties content long blueprint explicit ui expressions parent anchor duplication  
paranthesis detect files browser reify external language drag return binding id variables separator invokes tabs groups definition nil edit read  
extract inherits field operate accessor instance check count inject measure absent feedback added bundle dictionary write literal function constructor  
subsection chart candidates applied inherited based operation spaces multiplications god children complete accessing inst originate current state duplications  
silent navigation counter output duplicated xmetamodel metaclass folders make contents removed java mof parameters viewer sorting suffix tree base  
uuid dead size assignment root computed pressed editor cyclomatic symbol cvs bundles reject includes st cache left bindings conditionals short  
service treating sort earliest change error browse latest annotated put pure items behaviour install inheritances recursively sends space kill handle  
direct distribution omit models tag maximum matrix length replace tool send nesting dependencies including values descriptor object close token metric  
actions included intersect authors cascade squeak primitive include subcanvas jsp addressee server namespaces absolute satisfy start unknown splice  
button total higher originator reset condition mondrian stability invoke descriptions operator child fuzzy strange grouped question cdif fragments  
cohesion historical section characters defining late compilation equals interesting uninitialized temporaries uml sole big superclasses needed multiplier association  
dirty difference subclasses computable inspector aspect suplimentary map related clones prec occurrence structural grid store overridden kinds xmi union  
implementation high table distinct sequence part update cf complex unnamed behavioural positional fixed parser factor cancel internally widget percent  
bytes parcel extracted correlation filter understand process scan destination information sum panel stream increase correct selectors types scanner  
int categories exists moosify deviation request tcc bar auto const registry targets parcels shape home lan dataset deep strategy matches lonely

**class** named number import model reference version classes

method moose metamodel entity group add unique property initialize variable

compute expression set optimize view select history access list belongs methods importing

meta icon string interface default scope namespace menu source file famix attribute type stub package

description save comment ensure pre open declared defined create print accessed build inheritance attributes evolution

code local index block category accesses signatures threshold node extended boolean lines invocations spec signature

window basic complexity candidate empty global smalltalk display histories column remove parameter qualifier folder

control formal invocation label abstract simpl  hy protected var entities importer born

superclass receiving reduce selector selected pa ent changed text dependents implicit body

names pragma arguments action packages log fi present versions encoding invoked context

comments public prior full collect outgoing max ess export level occurrences favorites

accept clear message position recursive internal it ui expressions parent anchor duplication

paranthesis detect files browser reify external lang tor invokes tabs groups definition nil edit read

extract inherits field operate accessor instance check co undle dictionary write literal function constructor

subsection chart candidates applied inherited based opera delete accessing inst originate current state duplications

silent navigation counter output duplicated xmetamodel m mof parameters viewer sorting suffix tree base

uuid dead size assignment root computed pressed editor cyclomatic symbol cvs bundles reject includes st cache left bindings conditionals short

service treating sort earliest change error browse latest annotated put pure items behaviour install inheritances recursively sends space kill handle

direct distribution omit models tag maximum matrix length replace tool send nesting dependencies including values descriptor object close token metric

actions included intersect authors cascade squeak primitive include subcanvas jsp addressee server namespaces absolute satisfy start unknown splice

button total higher originator reset condition mondrian stability invoke descriptions operator child fuzzy strange grouped question cdif fragments

cohesion historical section characters defining late compilation equals interesting uninitialized temporaries uml sole big superclasses needed multiplier association

dirty difference subclasses computable inspector aspect supplementary map related clones prec occurrence structural grid store overridden kinds xmi union

implementation high table distinct sequence part update cf complex unnamed behavioural positional fixed parser factor cancel internally widget percent

bytes parcel extracted correlation filter understand process scan destination information sum panel stream increase correct selectors types scanner

int categories exists moosify deviation request tcc bar auto const registry targets parcels shape home lan dataset deep strategy matches lonely



# What we would like

Scripting

Instance based

Any data model

Close to data

Interaction



# What we would like

Scripting

Instance based

Any data model

Close to data

Interaction

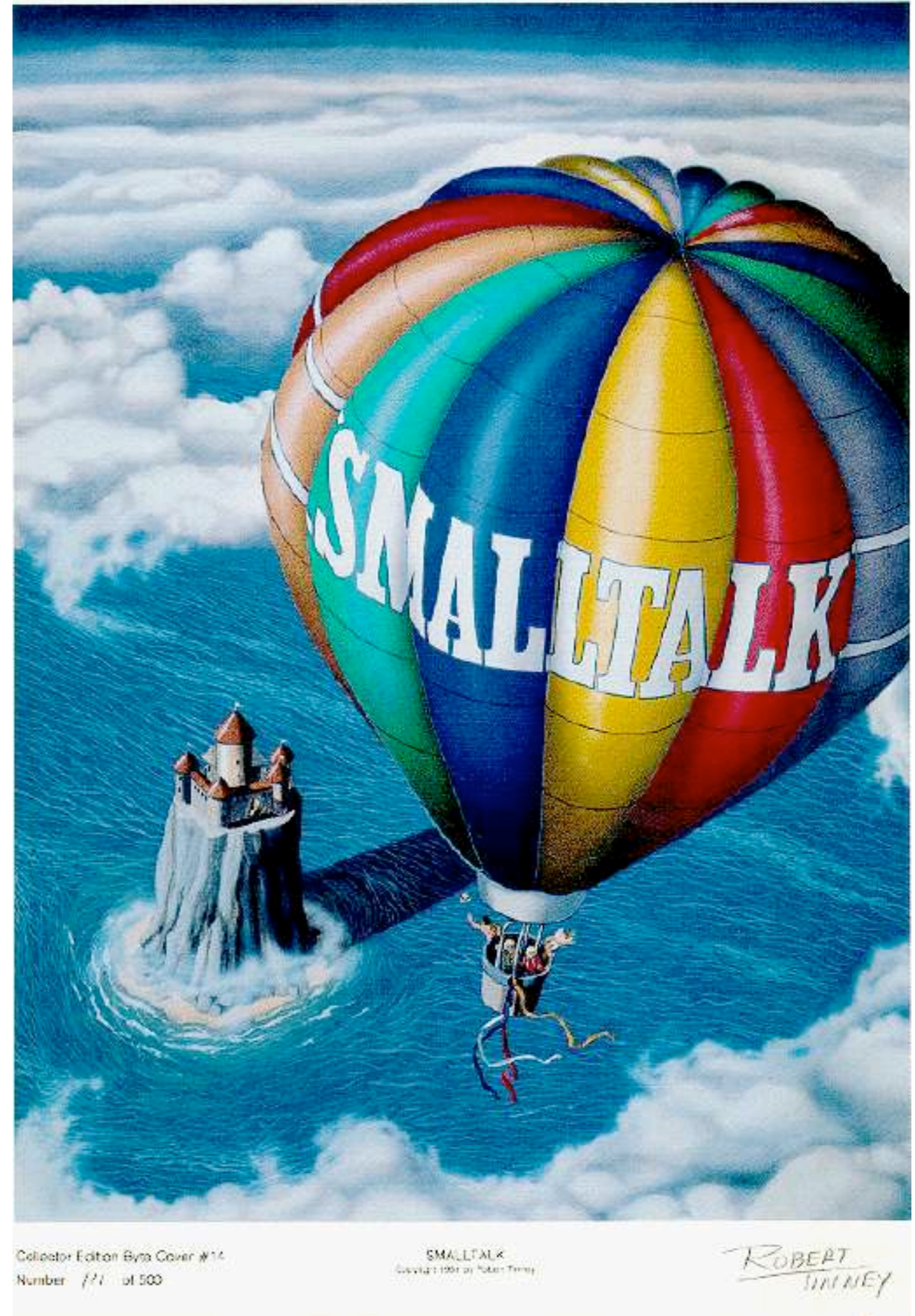



**Mondrian**

# Mondrian metaphor: painting a view

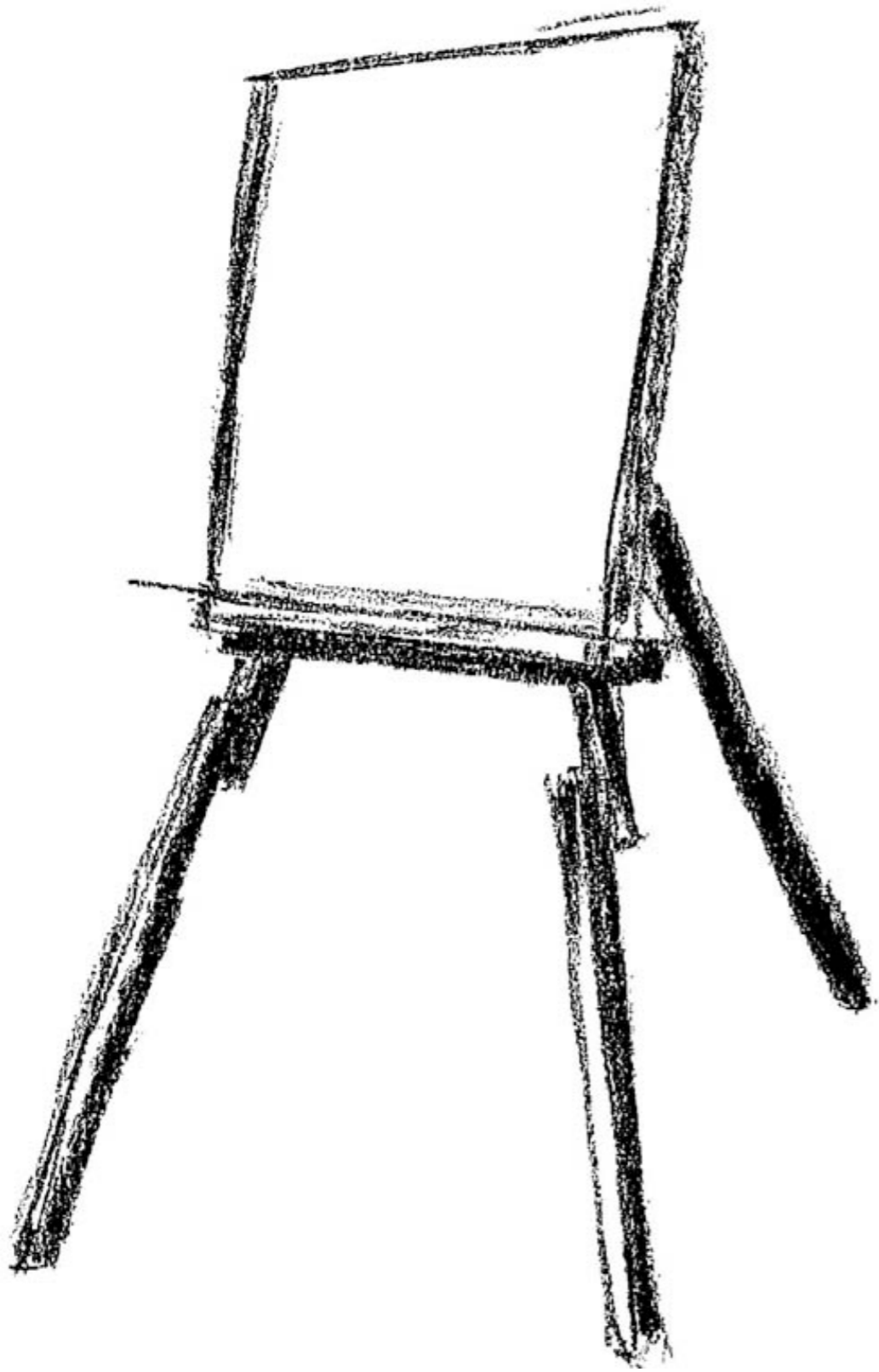

# Mondrian metaphor: painting a view

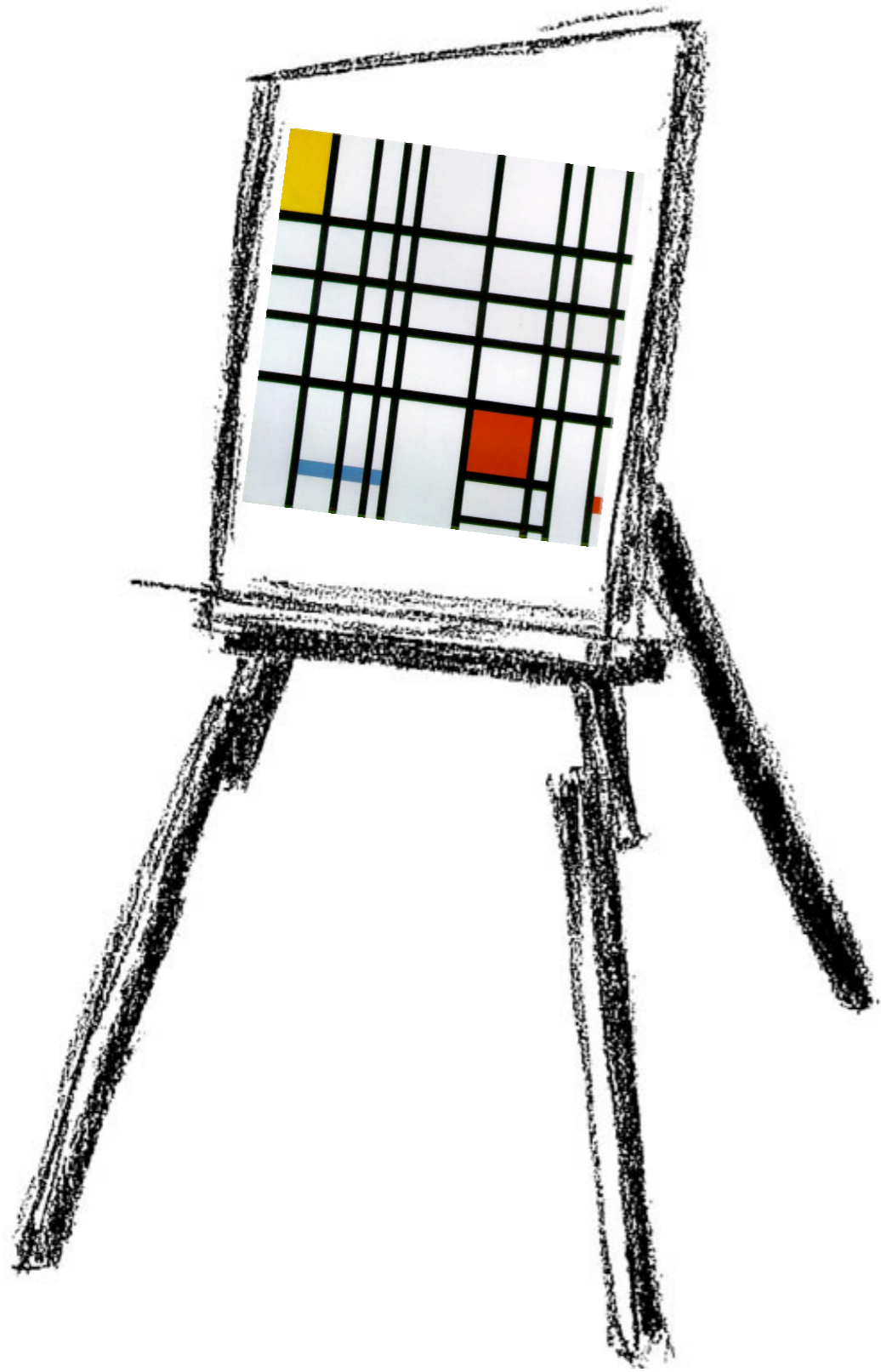

# Mondrian metaphor: painting a view

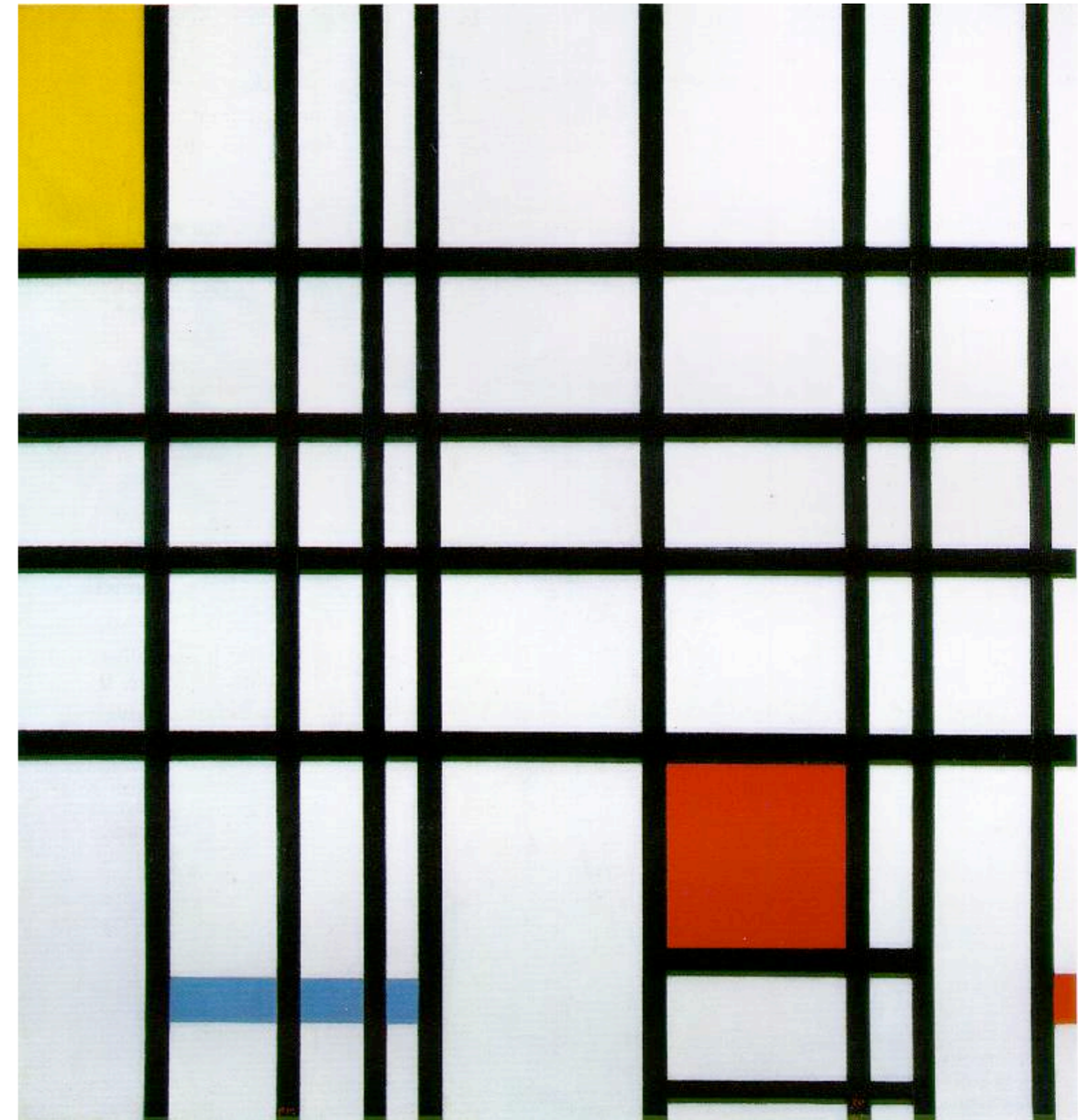
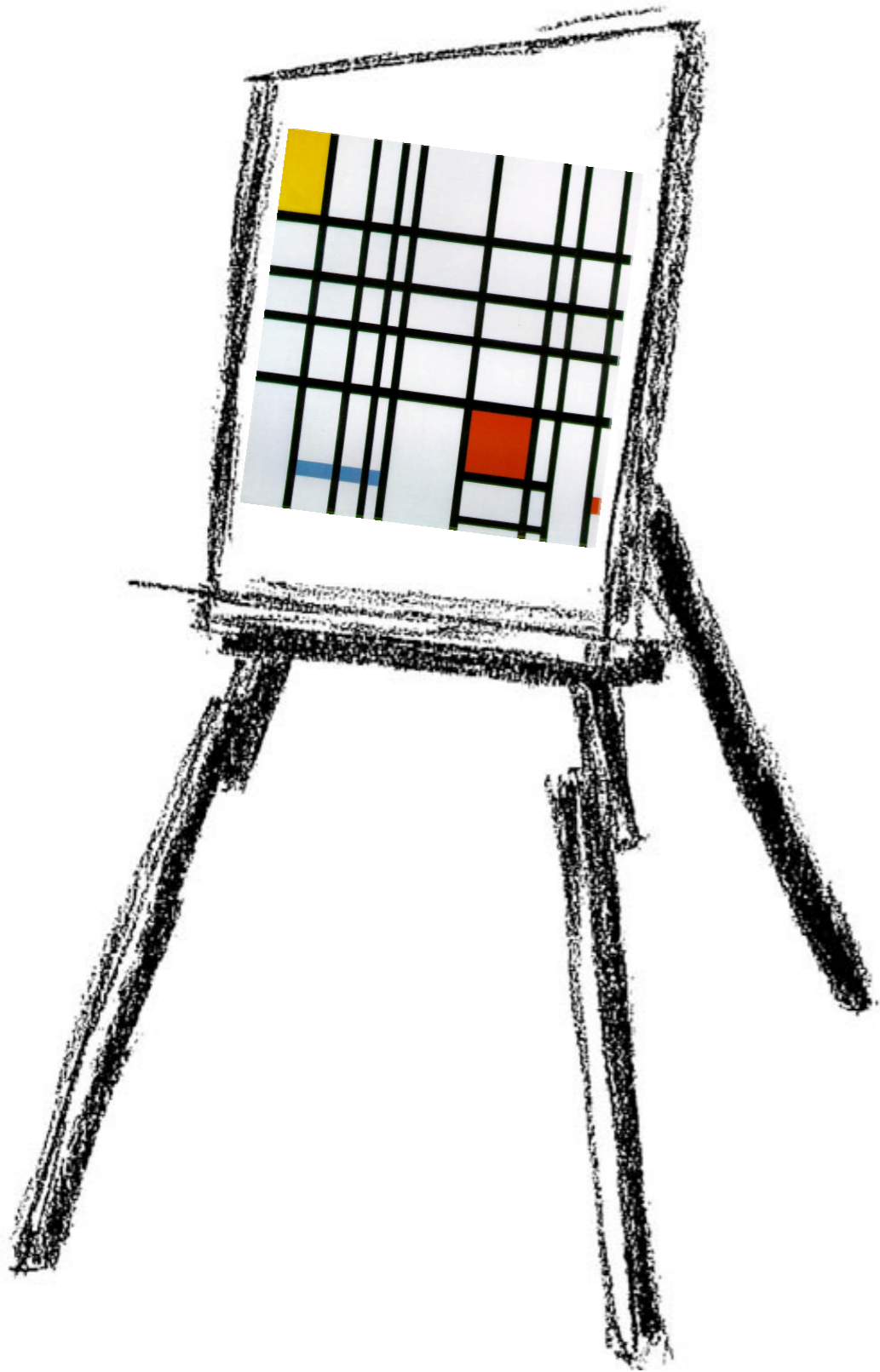

Composition with Red, Yellow and Blue  
Piet Mondrian (1921)

# The simplest Mondrian script is an empty view

```
view := ViewRenderer new.
```

```
view open.
```

# The view consists of nodes and edges arranged according to a layout

view := ViewRenderer new.

view **nodes:** classes.

view **edges:** classes **from:** [:each | each superclass] **to:** [:each | each].

view **treeLayout.**

view open.

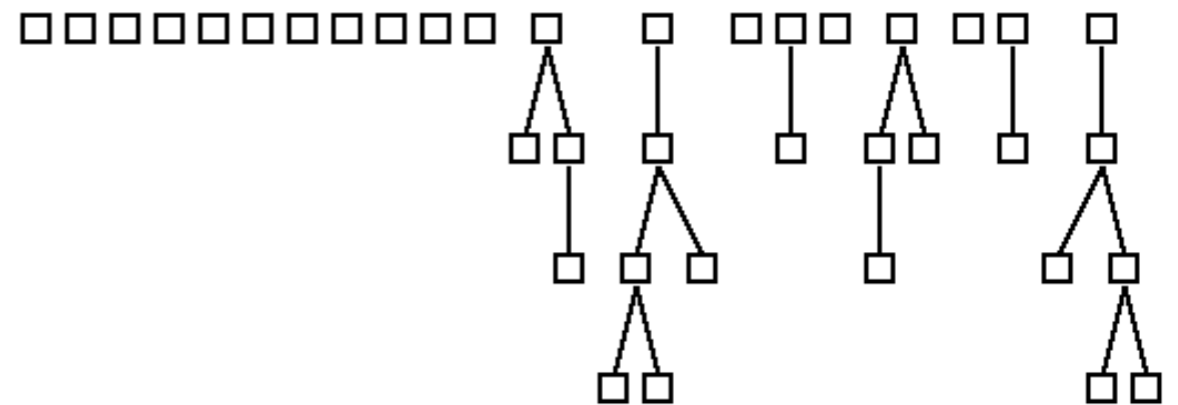

# Visual representation is given by the shape

view := ViewRenderer new.

view **borderedRectangleShape height:** [:each | each numberOfMethods].

view nodes: classes.

view edges: classes from: [:each | each superclass] to: [:each | each].

view treeLayout.

view open.

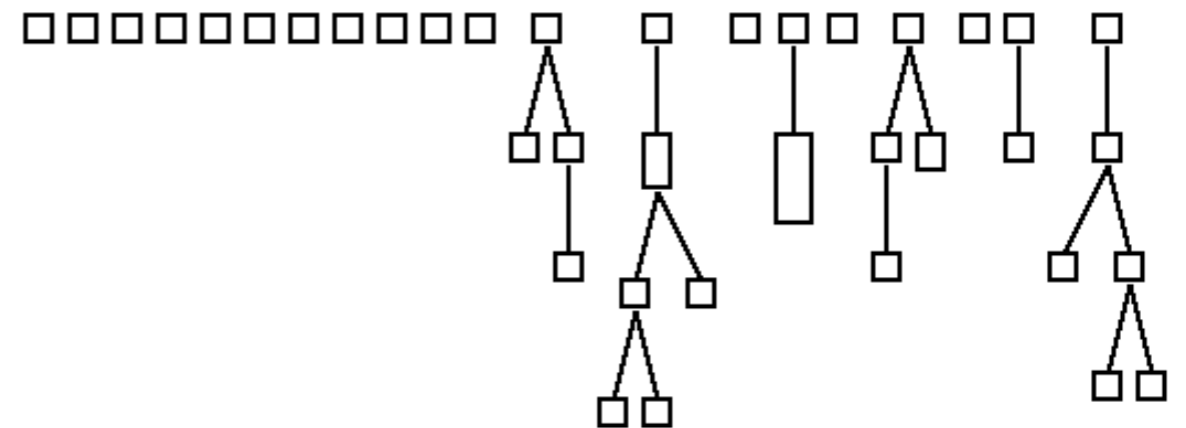

# Blocks can be replaced by symbols

view := ViewRenderer new.

view borderedRectangleShape height: **#numberOfMethods**.

view nodes: classes.

view edgesFrom: **#superclass**.

view treeLayout.

view open.

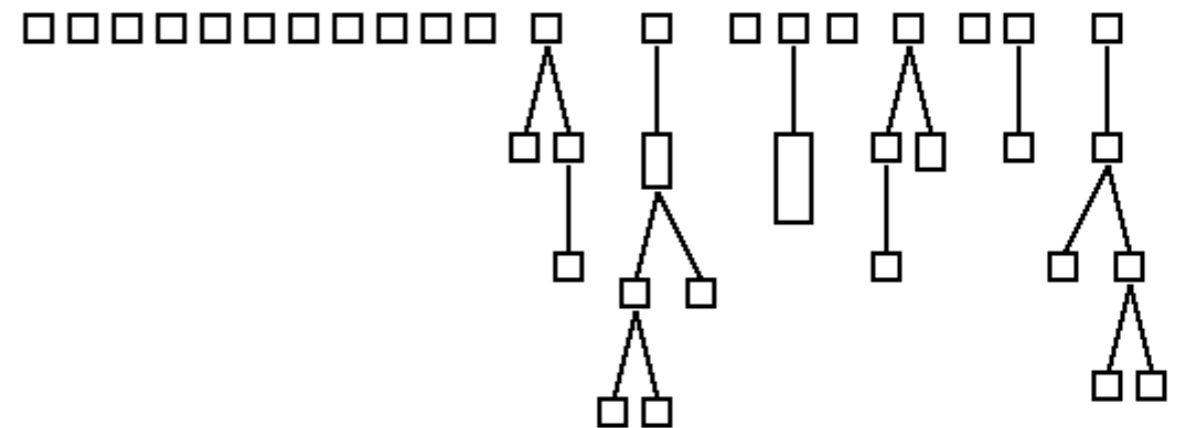



# Nesting is done through blocks

view := ViewRenderer new.

view borderedRectangleShape.

view **nodes:** classes **forEach:** [:each |

view **nodes:** each methods.

view **gridLayout**].

view edgesFrom: #superclass.

view treeLayout.

view open.

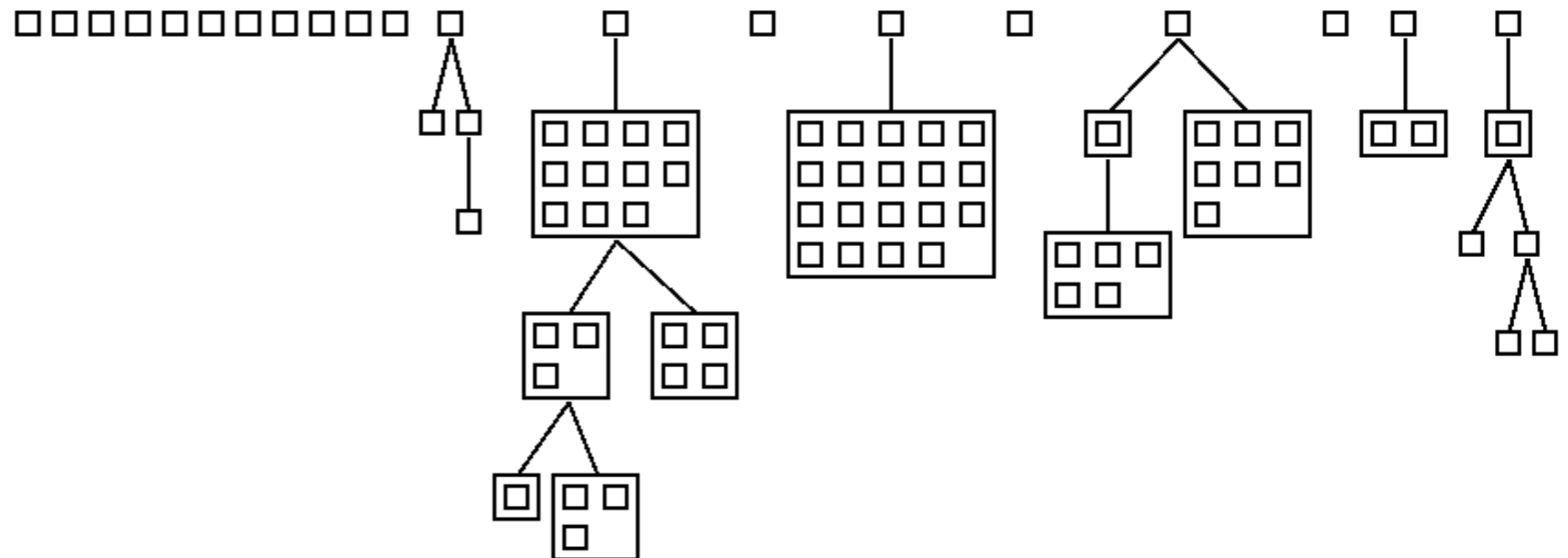

**What about interaction?**

# Interaction is scriptable, too

view := ViewRenderer new.

view2 := ViewRenderer new.

view **interaction onSelect:** [:each | each viewOn: view2].

view **interaction popupView:** [:each :aView | each viewOn: aView].

view nodes: ...

...

view open.

view2 open.

# Mondrian

Close to data

Any data model

Scripting

Interaction

Least object creation

Instance based

Soon in the Cincom Store ...

