

## Core Administration

---

---

## Zenoss Core Administration

Copyright © 2012 Zenoss, Inc., 275 West St. Suite 204, Annapolis, MD 21401, U.S.A. All rights reserved.

Zenoss and the Zenoss logo are trademarks or registered trademarks of Zenoss, Inc. in the United States and other countries. All other trademarks, logos, and service marks are the property of Zenoss or other third parties. Use of these marks is prohibited without the express written consent of Zenoss, Inc. or the third-party owner.

Flash is a registered trademark of Adobe Systems Incorporated.

Oracle, the Oracle logo, Java, and MySQL are registered trademarks of the Oracle Corporation and/or its affiliates.

Linux is a registered trademark of Linus Torvalds.

SNMP Informant is a trademark of Garth K. Williams (Informant Systems, Inc.).

Sybase is a registered trademark of Sybase, Inc.

Tomcat is a trademark of the Apache Software Foundation.

Windows is a registered trademark of Microsoft Corporation in the United States and other countries.

All other companies and products mentioned are trademarks and property of their respective owners.

Part Number: 02-062013-4.2-v06

---

---

1. About Zenoss Core .....	1
1.1. High-Level View .....	1
1.1.1. Key Tenets .....	2
1.2. Architecture and Technologies .....	3
1.2.1. User Layer .....	4
1.2.2. Data Layer .....	4
1.2.3. Process Layer .....	4
1.2.4. Collection Layer .....	4
1.3. Monitoring Approach .....	5
1.3.1. File System Monitoring .....	5
1.4. Terminology .....	6
2. Using Zenoss Core .....	8
2.1. Interface and Navigation .....	8
2.1.1. Navigation .....	9
2.1.2. User Information Area .....	9
2.1.3. Portlets .....	9
2.1.3.1. Customizing Portlets .....	10
2.1.3.2. Adding and Duplicating Portlets .....	11
2.1.4. Network Map .....	11
2.1.4.1. Choosing the Network to Display .....	11
2.1.4.2. Viewing Device and Network Details .....	11
2.1.4.3. Loading Link Data .....	12
2.1.4.4. Filtering by Device Type .....	12
2.1.4.5. Adjusting Viewable Hops .....	12
2.1.4.6. Adjusting the Network Map .....	12
2.1.4.7. Viewing Device or Network Details .....	12
2.2. Customizing the Dashboard .....	12
2.2.1. Selecting Portlets .....	13
2.2.2. Arranging Portlets .....	13
2.2.3. Changing the Dashboard Column Layout .....	13
2.3. Search .....	14
2.4. Navigating the Event Console .....	14
2.4.1. Sorting and Filtering Events .....	15
2.4.2. Saving a Custom View .....	16
2.4.3. Refreshing the View .....	16
2.4.4. Viewing Event Details .....	16
2.4.5. Selecting Events .....	17
2.4.6. Managing Events .....	17
2.5. Running Commands .....	18
2.6. Working with Triggers and Notifications .....	18
2.6.1. Working with Triggers .....	19
2.6.1.1. Creating a Trigger .....	19
2.6.1.2. Setting Global Trigger Permissions .....	20
2.6.1.3. Setting Individual Trigger Permissions .....	20
2.6.2. Working with Notifications .....	21
2.6.2.1. Creating or Editing a Notification .....	21
2.6.2.2. Defining Notification Content .....	23
2.6.2.3. Defining the SNMP Trap Host .....	28
2.6.2.4. Defining Commands to Run .....	28
2.6.2.5. Setting Global Notification Permissions .....	29
2.6.2.6. Setting Individual Notification Permissions .....	30
2.6.2.7. Setting Up Notification Schedules .....	30
2.7. Advanced User Interface Configuration .....	32
3. Adding, Discovering and Modeling Devices .....	33

---

---

3.1. Adding Devices .....	33
3.1.1. Add a Single Device .....	33
3.1.2. Add Multiple Devices .....	34
3.2. Discovering Devices .....	35
3.2.1. Classifying Discovered Devices .....	36
3.2.2. Updating Device Authentication Details .....	37
3.2.3. Adding Information to a Device Record .....	37
3.3. Modeling Devices .....	38
3.3.1. Modeling Devices Using SNMP .....	38
3.3.1.1. Testing to See if a Device is Running SNMP .....	38
3.3.1.2. Configuring Windows Devices to Provide Data Through SNMP .....	38
3.3.1.3. Configuring Linux Devices to Provide Data Through SNMP .....	39
3.3.2. Modeling Devices Using SSH/COMMAND .....	39
3.3.2.1. Using Device Class to Monitor Devices Using SSH .....	40
3.3.3. Modeling Devices Using Port Scan .....	40
3.3.3.1. Using the /Server/Scan Device Class to Monitor with Port Scan .....	41
3.4. About Modeler Plugins .....	41
3.4.1. Viewing and Editing Modeler Plugins for a Device .....	41
3.4.1.1. Adding Plugins .....	41
3.4.1.2. Reordering Plugins .....	42
3.4.1.3. Deleting Plugins from a Device .....	42
3.5. Debugging the Modeling Process .....	42
4. Working with Devices .....	43
4.1. Viewing the Device List .....	43
4.1.1. Devices Hierarchy .....	43
4.1.2. Managing Multiple Devices from the Device List .....	43
4.2. Working with Devices .....	44
4.2.1. Events .....	45
4.2.2. Components .....	46
4.2.3. Graphs .....	46
4.2.4. Modeler Plugins .....	48
4.2.5. Configuration Properties .....	48
4.2.6. Software .....	49
4.2.7. Administration .....	49
4.2.8. Custom Properties .....	49
4.2.9. Monitoring Templates .....	50
4.3. Managing Devices and Device Attributes .....	50
4.3.1. Clearing Heartbeat Events .....	51
4.3.2. Pushing Configuration Changes to Zenoss Core .....	51
4.3.3. Locking Device Configuration .....	51
4.3.4. Renaming a Device .....	52
4.3.5. Remodeling a Device .....	52
4.3.6. Resetting the Device Manage IP Address .....	52
4.3.7. Deleting a Device .....	53
4.3.8. Dumping and Loading Devices .....	53
5. Properties and Templates .....	55
5.1. Configuration Properties .....	55
5.1.1. Configuration Properties Inheritance and Override .....	55
5.1.1.1. Viewing Properties from the User Interface .....	57
5.1.2. Configuration Property Types .....	58
5.1.3. Device Configuration Properties .....	58
5.1.4. Event Configuration Properties .....	61
5.1.5. Network Configuration Properties .....	62
5.2. Templates .....	63

---

---

5.2.1. Copying Templates .....	63
5.2.2. Renaming Templates .....	63
5.2.3. Template Binding .....	64
5.2.3.1. Device Templates .....	64
5.2.3.2. Component Templates .....	65
5.2.3.3. Interface Templates .....	66
5.2.4. Examples .....	66
5.2.4.1. Example: Defining Templates in the Device Hierarchy .....	66
5.2.4.2. Example: Applying Templates to Multiple Areas in the Device Hierarchy .....	66
6. Core Monitoring .....	67
6.1. Availability Monitoring .....	67
6.1.1. Controlling Ping Cycle Time .....	67
6.1.2. Using the Predefined /Ping Device Class .....	68
6.1.3. Monitoring Processes .....	68
6.1.3.1. Monitoring a Process .....	69
6.1.4. Monitoring IP Services .....	69
6.1.4.1. Enabling IP Service Monitoring .....	70
6.1.4.2. Using the Predefined /Server/Scan Device Class .....	71
6.1.4.3. Choosing an IP Address to Check for IP Services .....	71
6.2. Performance Monitoring .....	71
6.2.1. About Performance Monitoring .....	71
6.2.2. About Monitoring Templates .....	72
6.2.2.1. Viewing Monitoring Templates .....	72
6.2.3. Template Binding .....	72
6.2.3.1. Binding Templates .....	73
6.2.4. Data Sources .....	73
6.2.4.1. Adding a Data Source .....	74
6.2.5. Data Points .....	74
6.2.6. Data Point Aliases .....	75
6.2.6.1. Alias Formula Evaluation .....	77
6.2.6.2. Adding a Data Point Alias .....	78
6.2.6.3. Reports That Use Aliases .....	78
6.2.7. Thresholds .....	78
6.2.7.1. MinMax Threshold .....	79
6.2.7.2. Adding Thresholds .....	79
6.2.8. Performance Graphs .....	81
6.2.8.1. Graph Points .....	82
6.2.8.2. Custom Graph Definition .....	85
6.2.8.3. Graph Commands .....	86
6.3. Monitoring Using ZenCommand .....	86
6.3.1. About ZenCommands .....	86
6.3.2. Example: Writing a ZenCommand (check_http example) .....	86
6.3.3. Example: Collect Data from A ZenCommand .....	88
6.3.4. Plugin Format for ZenCommands .....	88
6.3.5. Testing ZenCommands .....	89
6.4. SNMP Monitoring .....	90
6.5. Monitoring Devices Remotely Through SSH .....	90
6.5.1. Changing Zenoss Core to Monitor Devices Remotely Using SSH .....	91
6.5.2. Using the Predefined /Server/Command Device Class .....	92
6.6. Monitoring Windows Devices .....	92
6.6.1. Device Preparation for Windows Devices .....	92
6.6.2. Setting Windows Configuration Properties .....	92
6.6.3. Testing WMI on a Windows Server .....	93
6.6.4. Optional Windows Configuration .....	93

---

6.6.5. Modeling Services on Windows Devices .....	93
6.6.6. Collecting Windows Event Log Events .....	93
6.6.7. Monitoring Windows Performance with SNMP Informant .....	95
6.6.8. Running winexe Commands on Windows Servers .....	95
7. Event Management .....	97
7.1. About Events .....	97
7.1.1. Basic Event Fields .....	97
7.1.1.1. device and ipAddress Fields .....	97
7.1.1.2. eventState Field .....	98
7.1.1.3. severity Field .....	98
7.1.1.4. summary and message Fields .....	98
7.1.2. Other Fields .....	99
7.1.3. Details .....	100
7.1.4. De-Duplication .....	100
7.1.5. Auto-Clear Correlation .....	101
7.1.6. Event Consoles .....	102
7.1.6.1. Master Event Console .....	102
7.1.6.2. Creating Events .....	110
7.1.7. Event Sources .....	110
7.1.7.1. Generated Events .....	110
7.1.7.2. Captured Events .....	110
7.1.8. Creating Events Manually .....	110
7.1.8.1. Creating Events through the User Interface .....	110
7.1.8.2. Creating Events from the Command Line .....	111
7.1.9. Event Classes .....	111
7.1.9.1. Event Class Configuration Properties .....	112
7.1.10. Mapping and Transformation .....	112
7.1.10.1. Event Class Mappings .....	114
7.1.10.2. Event Class Mapping Sequence .....	115
7.1.10.3. Event Class Transform .....	115
7.1.11. Event Life Cycle .....	115
7.1.11.1. Automatic Event Aging .....	116
7.1.11.2. Automatic Archived Event Cleanup .....	116
7.1.12. Capturing Email Messages as Events .....	117
7.1.12.1. ZenMail .....	117
7.1.12.2. ZenPop .....	117
7.1.12.3. Translating Message Elements to the Event .....	117
7.1.13. SNMP Traps and Event Transforms .....	118
7.1.13.1. Classifying SNMP Traps .....	118
7.1.13.2. Example: Sending Test Traps .....	119
7.1.13.3. Transforming Events with Event Mappings .....	120
7.1.13.4. Event Transforms Based on Event Class .....	121
8. Production States and Maintenance Windows .....	122
8.1. About Production States and Maintenance Windows .....	122
8.2. Production States .....	122
8.2.1. Setting the Production State for Devices .....	122
8.3. Maintenance Windows .....	123
8.3.1. Maintenance Window Events .....	123
8.3.2. Creating and Using Maintenance Windows .....	124
8.3.2.1. Create a Maintenance Window for a Single Device .....	124
8.3.2.2. Create a Maintenance Window for a Group of Devices .....	124
9. Organizers and Path Navigation .....	126
9.1. About Organizers and Path Navigation .....	126
9.2. Classes .....	126

9.2.1. Viewing Device Classes .....	127
9.2.2. Adding Classes .....	127
9.2.2.1. Moving a Class .....	128
9.2.3. Setting Configuration Properties at the Class Level .....	128
9.3. Systems .....	129
9.3.1. Adding Systems .....	129
9.3.1.1. Moving a System .....	129
9.4. Groups .....	129
9.4.1. Adding Groups .....	130
9.4.1.1. Moving a Group .....	130
9.5. Locations .....	130
9.5.1. Adding Locations .....	130
9.5.1.1. Moving a Location .....	131
9.5.2. Integration with Google Maps .....	131
9.5.2.1. Obtaining an API Key .....	132
9.5.2.2. Setting an Address for a Location .....	134
9.5.2.3. Clearing the Google Maps Cache .....	134
9.5.2.4. Network Links .....	134
9.5.2.5. Google Maps Example .....	135
9.6. Inheritance .....	136
10. User Commands .....	138
10.1. About User Commands .....	138
10.2. Defining Global User Commands .....	138
10.2.1. Running Global User Commands .....	138
10.3. Defining User Commands for a Single Device .....	139
10.3.1. Running User Commands for a Single Device .....	140
10.4. Defining User Commands for All Devices in an Organizer .....	140
10.4.1. Running User Commands for Devices in an Organizer .....	140
10.5. User Command Example: Echo Command .....	141
11. Managing Users .....	142
11.1. About User Accounts .....	142
11.2. Creating User Accounts .....	142
11.3. Editing User Accounts .....	142
11.3.1. Associating Objects with Specific Users .....	143
11.3.1.1. Adding Administrators .....	145
11.4. User Groups .....	145
11.4.1. Viewing User Groups .....	145
11.4.2. Creating User Groups .....	145
11.5. Roles .....	146
12. Reporting .....	147
12.1. About Reporting .....	147
12.1.1. Organizing Reports .....	147
12.2. Basic Reports .....	148
12.2.1. Device Reports .....	148
12.2.2. Event Reports .....	149
12.2.3. Performance Reports .....	150
12.3. Graph Reports .....	152
12.3.1. Creating a Graph Report .....	152
12.3.1.1. Adding Graphs .....	153
12.3.2. Customizing Graph Text .....	154
12.3.3. Printing Graphs .....	155
12.3.4. Organizing Graphs .....	155
12.4. Multi-Graph Reports .....	155
12.4.1. Creating A Multi-Graph Report .....	155

12.4.1.1. Adding Collections .....	156
12.4.1.2. Adding Graph Definitions .....	157
12.4.1.3. Adding Graph Groups .....	158
12.5. Creating Custom Device Reports .....	159
12.6. Exporting Reports .....	160
12.6.1. Advanced Task: Add An Export Button to a Report .....	161
12.7. Scheduling Reports .....	161
12.7.1. ReportMail Command Line Arguments .....	162
12.8. Using Reports to Troubleshoot System Daemons .....	163
13. ZenPacks .....	164
13.1. About ZenPacks .....	164
13.2. Viewing ZenPacks .....	164
13.3. Installing ZenPacks .....	165
13.3.1. Installing from the User Interface .....	165
13.3.2. Installing from the Command Line .....	165
13.4. Upgrading ZenPacks .....	166
13.5. Deleting ZenPacks .....	166
13.6. ZenPack Information Resources .....	167
14. General Administration and Settings .....	168
14.1. Events Settings .....	168
14.1.1. Changing Events Database Connection Information .....	168
14.1.2. Changing Events Maintenance Settings .....	168
14.2. Rebuilding the Events Index .....	169
14.3. Enabling HTTPS Support .....	169
14.4. Setting Portlet Permissions .....	169
14.4.1. User Role to ACL Mapping .....	170
14.4.2. Setting Permissions .....	170
14.4.3. Troubleshooting: Users Cannot See All Portlets .....	170
14.5. Backup and Recovery .....	171
14.5.1. Backup (zenbackup) .....	171
14.5.1.1. Backup Options .....	171
14.5.1.2. Create a Backup .....	173
14.5.1.3. Delete a Backup .....	173
14.5.1.4. Remote Backups .....	174
14.5.2. Restore (zenrestore) .....	174
14.5.2.1. Restore Options .....	174
14.6. Working with the Job Manager .....	174
14.6.1. Viewing Jobs .....	174
14.6.2. Running the zenjobs Daemon .....	175
14.7. Host Name Changes .....	176
14.8. Versions and Update Checks .....	176
A. Daemon Commands and Options .....	177
A.1. Automated Modeling Daemons .....	177
A.1.1. zendisc .....	177
A.1.2. zenmodeler .....	177
A.2. Availability Monitoring Daemons .....	177
A.2.1. zenping .....	177
A.2.2. zenstatus .....	177
A.2.3. zenprocess .....	177
A.3. Event Collection Daemons .....	177
A.3.1. zensyslog .....	177
A.3.2. zeneventlog .....	178
A.3.3. zentrap .....	178
A.4. Performance Monitoring Daemons .....	178



- A.4.1. zenperfsnmp ..... 178
    - A.4.2. zencommand ..... 178
  - A.5. Automated Response Daemons ..... 178
    - A.5.1. zenactiond ..... 178
- B. SNMP Device Preparation ..... 180
  - B.1. Net-SNMP ..... 180
  - B.2. SNMP V3 Support ..... 180
    - B.2.1. Advanced Encryption Standard ..... 180
  - B.3. Community Information ..... 181
  - B.4. System Contact Information ..... 181
  - B.5. Extra Information ..... 181
- C. Syslog Device Preparation ..... 183
  - C.1. Forwarding Syslog Messages from UNIX/Linux Devices ..... 183
  - C.2. Forwarding Syslog Messages from a Cisco IOS Router ..... 183
    - C.2.1. Other Cisco Syslog Configurations ..... 183
  - C.3. Forwarding Syslog Messages from a Cisco CatOS Switch ..... 184
  - C.4. Forwarding Syslog Messages using Syslog-ng ..... 184
- D. TALES Expressions ..... 186
  - D.1. About Tales Expressions ..... 186
    - D.1.1. Examples ..... 186
  - D.2. TALES Device Attributes ..... 186
  - D.3. Tales Event Attributes ..... 187

---

# Chapter 1. About Zenoss Core

Zenoss Core is today's premier, open source IT management solution. Through a single, Web-based console, it enables you to manage the status and health of your infrastructure.

The power of Zenoss Core starts with its in-depth Inventory and IT Configuration Database. It creates this database by discovering *managed resources* -- servers, networks, and other devices -- in your IT environment. The resulting configuration model provides a complete inventory of your servers, network devices, and software applications, down to the level of *resource components* (interfaces, services and processes, and installed software).

Once Zenoss Core discovers the IT infrastructure, it automatically begins monitoring the performance of each device. It also provides events and fault management features that tie into the configuration database. These features help drive operational efficiency and productivity by automating many of the notification, alerts, escalation, and remediation tasks you perform each day.

## 1.1. High-Level View

Using agent-less technology, Zenoss Core monitors your entire IT infrastructure stack, including network, servers, HVAC and power, and even applications. At its highest level, the system comprises these major areas:

- Discovery and configuration
- Performance and availability
- Fault and event management
- Alerting and remediation
- Reporting

Zenoss Core unifies these areas into a single system with a fully featured, interactive Web user interface.

Figure 1.1. High-Level View

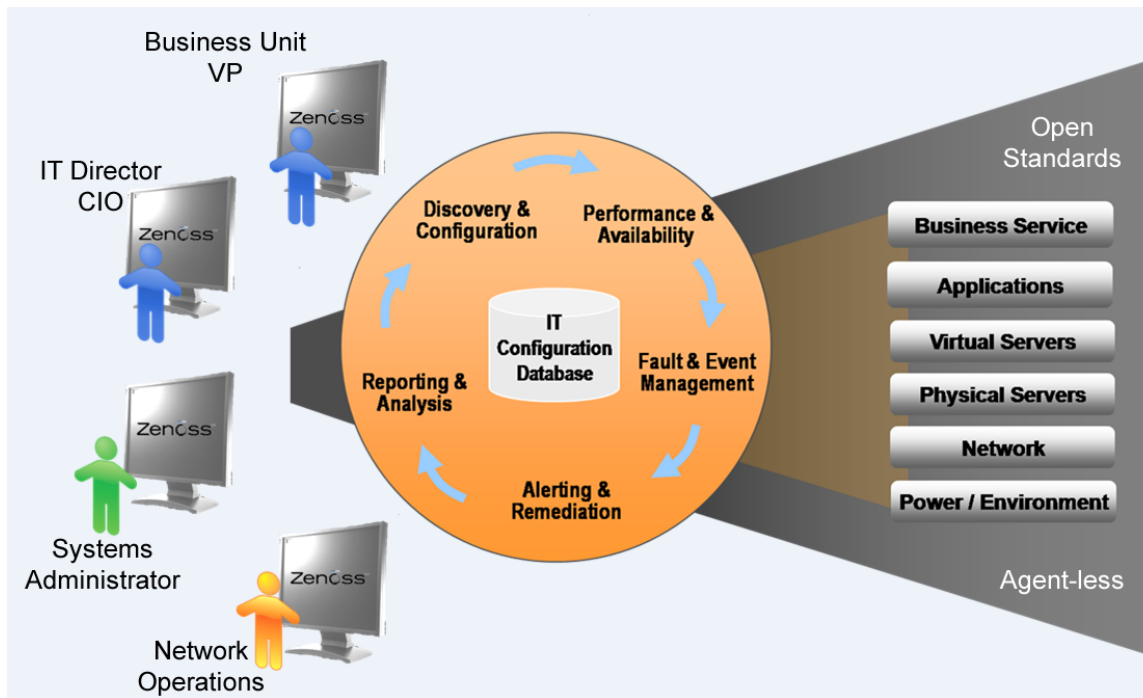

### 1.1.1. Key Tenets

Zenoss Core was designed with these important ideas at its core:

- **Modeling**

The system's model enables it to understand the environment in which it operates. Through sophisticated and detailed analysis, Zenoss Core determines how to monitor and manage complex IT environments. The core of the standard model describes basic information about each device's operating system and hardware. The model is object-based, and is easily extended through object inheritance.

- **Discovery**

With a sophisticated model, manual input and maintenance of data is challenging. To address this challenge, Zenoss Core uses *discovery* to populate the model. During discovery, the system accesses each monitored device in your infrastructure and interrogates it in detail, acquiring information about its components, network integration, and dependencies.

- **Normalization**

Because Zenoss Core collects information from different platforms and through different protocols, the amount and format of available information varies. For example, file system information gathered from a Linux server differs from similar information gathered from a Windows server. Zenoss Core standardizes the data gathered so that you can perform valid comparisons of metrics gathered by different methods and for different systems.

- **Agentless Data Collection**

To gather information, Zenoss Core relies on agent-less data collection. By communicating with a device through one of several protocols (including SNMP, SSH, Telnet, and WMI), it minimizes the impact on monitored systems.

- **Full IT Infrastructure**

Unlike other tools, the system's inclusive approach unifies all areas of the IT infrastructure--network, servers, and applications--to eliminate your need to access multiple tools.

- **Configuration Inheritance**

Zenoss Core extends the concept of inheritance in object-oriented languages to configuration. All core configuration parameters (*configuration properties*) and monitoring directions (*monitoring templates*) use inheritance to describe how a device should be monitored. Inheritance allows you to describe, at a high level, how devices should be monitored. It also supports ongoing refinements to the configuration. (For detailed information on inheritance and templates, refer to the chapter titled "Properties and Templates.")

- **Cross-Platform Monitoring**

Zenoss Core monitors the performance and availability of heterogeneous operating systems, SNMP-enabled network devices, and a variety of software applications.

- **Scale**

You can deploy the system on a single server to manage hundreds of devices.

- **Extensibility**

The system's extension mechanism, ZenPacks, allow for rapid addition and modification to customize your environment.

## 1.2. Architecture and Technologies

The following diagram illustrates the system architecture.

**Figure 1.2. Architecture**

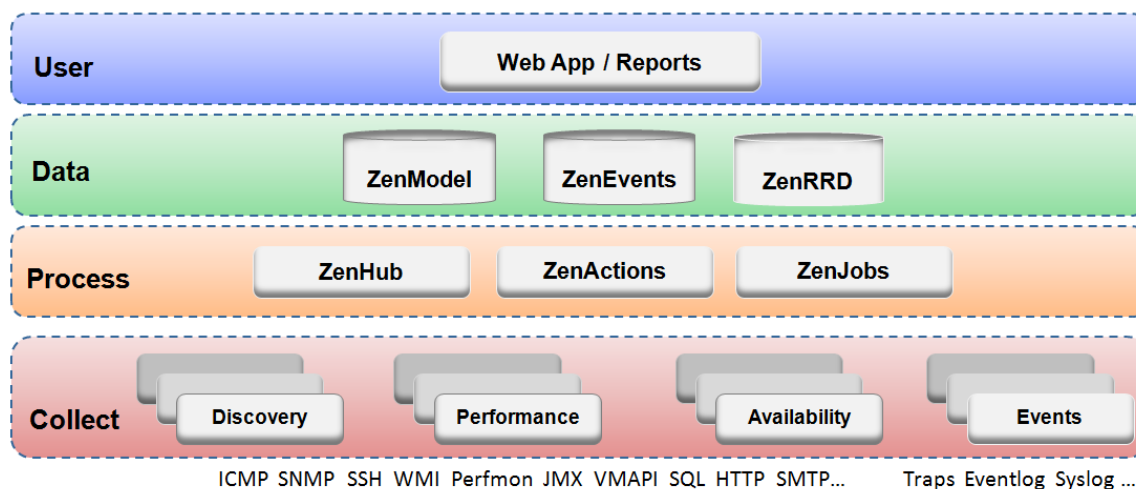

Zenoss Core is a tiered system with four major parts:

- User layer
- Data layer
- Processing layer

- Collection layer

### 1.2.1. User Layer

Built around the Zope Web application environment, the user layer is manifested as a Web portal. It uses several JavaScript libraries, Mochi Kit, YUI, and extJS to provide a rich application experience.

Through the user interface, you access and manage key components and features. From here, you can:

- Watch the status of your enterprise, using the Dashboard
- Work with devices, networks, and systems
- Monitor and respond to events
- Manage users
- Create and run reports

The user layer Interacts with the data layer and translates the information for display in the user interface.

### 1.2.2. Data Layer

Configuration and collection information is stored in the data layer, in three separate databases:

- **ZenRRD** - Utilizing RRDtool, stores time-series performance data. Because RRD files are stored locally to each collector, no bottlenecks result from writing to a single database as new collectors are added.
- **ZenModel** - Serves as the core configuration model, which comprises devices, their components, groups, and locations. ZODB persists this data in a MySQL database.
- **ZenEvents** - Stores event data in a MySQL database.

### 1.2.3. Process Layer

The process layer manages communications between the collection and data layers. It also runs back-end, periodic jobs, as well as jobs initiated by the user (ZenActions and ZenJobs).The process layer utilizes Twisted PB (a bi-directional RPC system) for communications.

### 1.2.4. Collection Layer

The collection layer comprises services that collect and feed data to the data layer. These services are provided by numerous daemons that perform modeling, monitoring, and event management functions.

The modeling system uses SNMP, SSH, and WMI to collect information from remote machines. The raw information is fed into a plugin system (*modeling plugins*) that normalizes the data into a format that matches the core model.

Monitoring daemons track the availability and performance of the IT infrastructure. Using multiple protocols, they store performance information locally in RRD files, thus allowing the collectors to be spread out among many collector machines. Status and availability information, such as ping failures and threshold breaches, are returned through ZenHub to the event system.

For more information about system daemons, see the appendix titled "Daemon Commands and Options."

## 1.3. Monitoring Approach

Zenoss Core uses a model-driven approach to monitoring, combining discovery and the model to enable automatic monitoring. This strategy reduces system maintenance overhead and ensures that new devices and applications are monitored as they come online.

**Figure 1.3. Workflow: Model-Driven Monitoring**

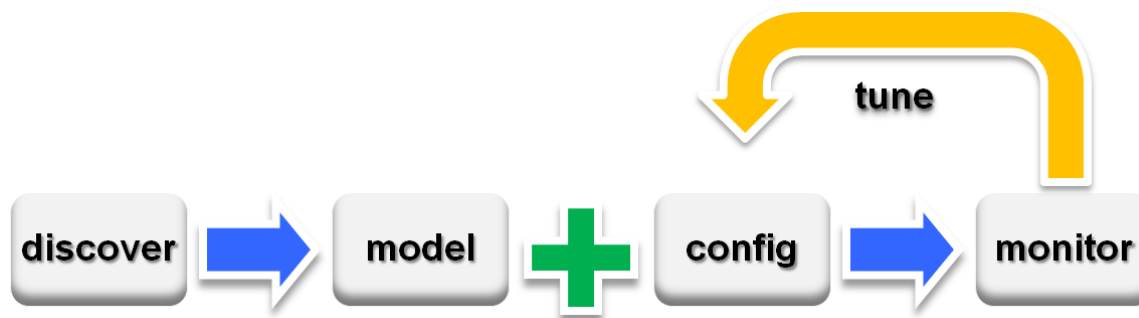

As shown in the illustration, model-driven monitoring begins with discovery, which populates the model. It continues as the configuration defined in the model is automatically applied and monitoring begins. As the system runs, the configuration is further fine-tuned.

The model-driven monitoring approach is demonstrated by the following file system monitoring scenario.

### 1.3.1. File System Monitoring

By default, the system is configured with a file system threshold of 90% utilization. Each time it discovers a file system, this threshold is automatically applied to the file system, and monitoring begins.

**Figure 1.4. Monitored File System (Threshold Exceeded)**

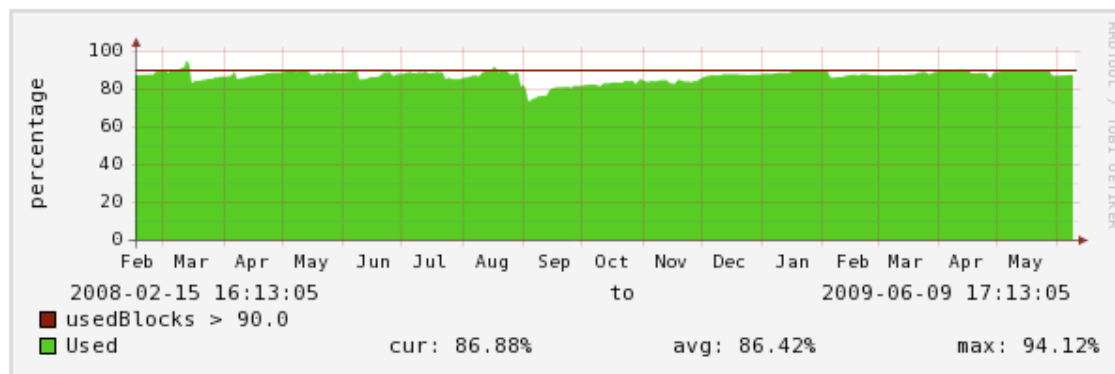

This illustration shows the result of a system being monitored, using the default configuration. The graph shows that the threshold of 90% has been exceeded numerous times. Because the data in the model is normalized, thresholds will apply regardless of the collection mechanism (SNMP, SSH, and WMI).

The chapter titled "Properties and Templates" provides more information about modifying the monitoring configuration.

## 1.4. Terminology

You should understand product-specific use of the following terms when working with the system.

### Glossary

data point	Data returned from a data source. In many cases, there is only one data point for a data source (such as in SNMP); but there may also be many data points for a data source (such as when a command results in the output of several variables).
data source	Method used to collect monitoring information. Example data sources include SNMP OIDs, SSH commands, and perfmon paths.
device	Primary monitoring object in the system. Generally, a device is the combination of hardware and an operating system.
device class	Special type of organizer used to manage how the system models and monitors devices (through configuration properties and monitoring templates).
device component	Object contained by a device. Components include interfaces, OS processes, file systems, CPUs, and hard drives.
discovery	Process by which Zenoss Core gathers detailed information about devices in the infrastructure. Results of discovery are used to populate the model.
event	Manifestation of important occurrence within the system. Events are generated internally (such as when a threshold is exceeded) or externally (such as through a syslog message or SNMP trap).
event class	Categorization system used to organize event rules.
event rules	Controls how events are manipulated as they enter the system (for example, changing the severity of an event). Configuration properties configure event rules.
graph	Displays one or more data points, thresholds, or both.
managed resource	Servers, networks, virtual machines, and other devices in the IT environment.
model	Representation of the IT infrastructure. The model tells the system "what is out there" and how to monitor it.
monitoring template	Description of what to monitor on a device or device component. Monitoring templates comprise four main elements: data sources, data points, thresholds, and graphs.
notification	Sends email or pages to system users or groups when certain events occur.
organizer	Hierarchical system used to describe locations and groups. Zenoss Core also includes special organizers, which are classes that control system configuration.
resource component	Interfaces, services and processes, and installed software in the IT environment.
threshold	Defines a value beyond which a data point should not go. When a threshold is reached, the system generates an event. Typically, threshold events use the /Perf event class.

trigger

Determines how and when notifications are sent. Specifies a rule comprising a series of one or more conditions.



# Chapter 2. Using Zenoss Core

Read the following sections to learn more about working in the interface, and how to:

- Customize the dashboard
- Search for devices, events, and system objects
- Navigate the event console
- Run commands
- Work with triggers and notifications
- Make advanced UI configuration selections

## 2.1. Interface and Navigation

After you install Zenoss Core and navigate to the interface from your Web browser, the Dashboard appears. The Dashboard provides at-a-glance information about the status of your IT infrastructure. It is the primary window into devices and events that the system enables you to monitor.

**Figure 2.1. Dashboard**

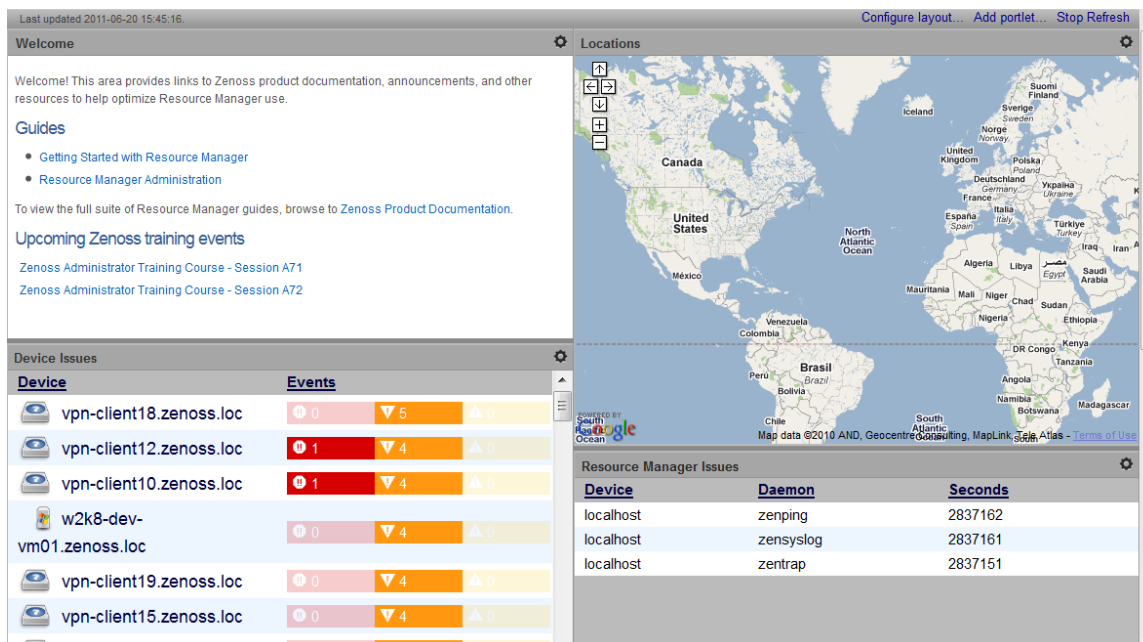

The Dashboard can show:

- System information resources and Web pages
- Important error-level device events
- Geographical high-level view
- "Troubled" devices

Key Dashboard and interface areas include:

- Navigation menu
- User information area
- Portlets
- System Network Map

## 2.1.1. Navigation

The Navigation menu lets you access major system features. In addition to the Dashboard, the menu is divided among several functional areas:

- **Events** - Guides you to the event management area, where you can monitor event status, triggers, and event transforms. You also can track changes made to events.
- **Infrastructure** - Offers access to network infrastructure, including, devices, networks, processes, and services.
- **Reports** - Allows you to view and define reports.
- **Advanced** - Provides access to monitoring templates, collectors, MIBs, and system settings.

## 2.1.2. User Information Area

Figure 2.2. User Information Area

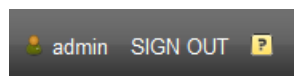

The User information area offers information and selections:

- **Login ID** - The ID of the user currently logged in appears at the far left of this area. Click the ID to edit user settings, such as authentication information, roles, and groups. (You also can access user settings from the Navigation menu Advanced selection.)
- **Sign Out** - Click to log out of the system.
- **?** (**Help**) - Click to access product documentation.

## 2.1.3. Portlets

The main content of the Dashboard comprises portlets, which provide information about the system and your infrastructure. Portlets you can display on the dashboard are:

- **Device Issues** - Displays a list of devices, associated with color-coded events of critical, error, or warning severity levels. Click a device name to view details, or click an event to go to the event console for the device.

Figure 2.3. Device Issues Portlet

Device	Events
vpn-client18.zenoss.loc	0 Critical, 5 Warning, 0 Error
vpn-client12.zenoss.loc	1 Critical, 4 Warning, 0 Error
vpn-client10.zenoss.loc	1 Critical, 4 Warning, 0 Error
w2k8-dev-vm01.zenoss.loc	0 Critical, 4 Warning, 0 Error
vpn-client19.zenoss.loc	0 Critical, 4 Warning, 0 Error
vpn-client15.zenoss.loc	0 Critical, 4 Warning, 0 Error
vpn-client13.zenoss.loc	0 Critical, 4 Warning, 0 Error
test-rhel54-64-1.zenoss.loc	0 Critical, 4 Warning, 0 Error
test-cent5-32-3.zenoss.loc	0 Critical, 4 Warning, 0 Error

- **Google Maps** (device locations) - Shows configured locations and configured network connections.

**Figure 2.4. Google Maps Portlet**

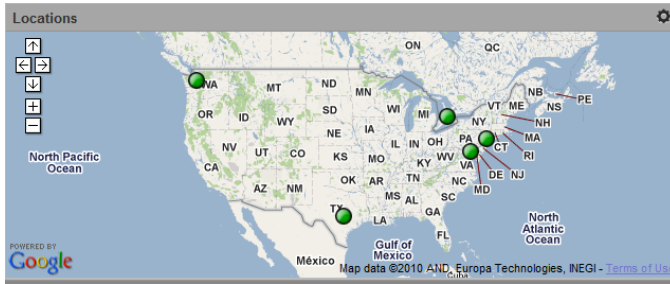

- **Daemon Processes Down** - Contains system self-monitoring information.
- **Production States** - Shows devices assigned to a particular production state.
- **Site Window** - Initially provides links to resources such as product guides, forums, and training events.

The URL for the default content is <http://www2.zenoss.com/in-app-welcome-sd?v=ProductVersion>. You can customize this portlet to display content from any URL.

- **Top Level (Root) Organizers** - Lists status for each grouping in your defined system hierarchy.

**Figure 2.5. Top Level Organizers Portlet**

Object	Events
/Devices/Discovered	11 (red), 207 (orange), 0 (yellow)
/Devices/Network	0 (red), 0 (orange), 0 (yellow)
/Devices/Server	2 (red), 17 (orange), 1 (yellow)
/Devices/Printer	0 (red), 1 (orange), 0 (yellow)
/Devices/Power	1 (red), 2 (orange), 0 (yellow)
/Devices/Ping	0 (red), 0 (orange), 0 (yellow)

- **Messages** - Displays system messages.
- **Object Watch List** - Allows the display of high-level status device classes, groups, systems, event classes, and locations that you select.

### 2.1.3.1. Customizing Portlets

You can customize each portlet that appears on the Dashboard. Customization options vary depending on the portlet type.

Click , which appears at the top right corner of a portlet, to view and customize display options. Click **Save Settings** to save your selections and then return to main portlet content.

The following table lists information you can customize for each Zenoss Core portlet.

For this portlet type..	...you can customize:
Welcome	Title, Refresh Rate, Destination URL
Device Issues	Title, Refresh Rate

For this portlet type..	...you can customize:
Google Maps	Title, Refresh Rate, Base Location
Zenoss Core Issues	Title, Refresh Rate
Production States	Title, Refresh Rate, Production States (to appear on the Dashboard)
Top Level (Root Organizers)	Title, Refresh Rate, Root Organizer (to appear on the Dashboard)

### 2.1.3.2. Adding and Duplicating Portlets

To add a portlet, select Add portlet (located below the User Information area at the top right of the Dashboard). From the Add Portlet dialog, you can add a portlet or restore portlets to the default view.

Your Dashboard can display more than one of the same portlet type. You might want to display duplicate portlets, for example, to get at-a-glance information about more than one device location that appears in the Google Maps portlet.

### 2.1.4. Network Map

The Network Map represents your network's Layer 3 topology. From the map, you can quickly determine the status of each device by its highlighted color.

To access the network map, select Infrastructure, and then select Network Map.

**Figure 2.6. Network Map**

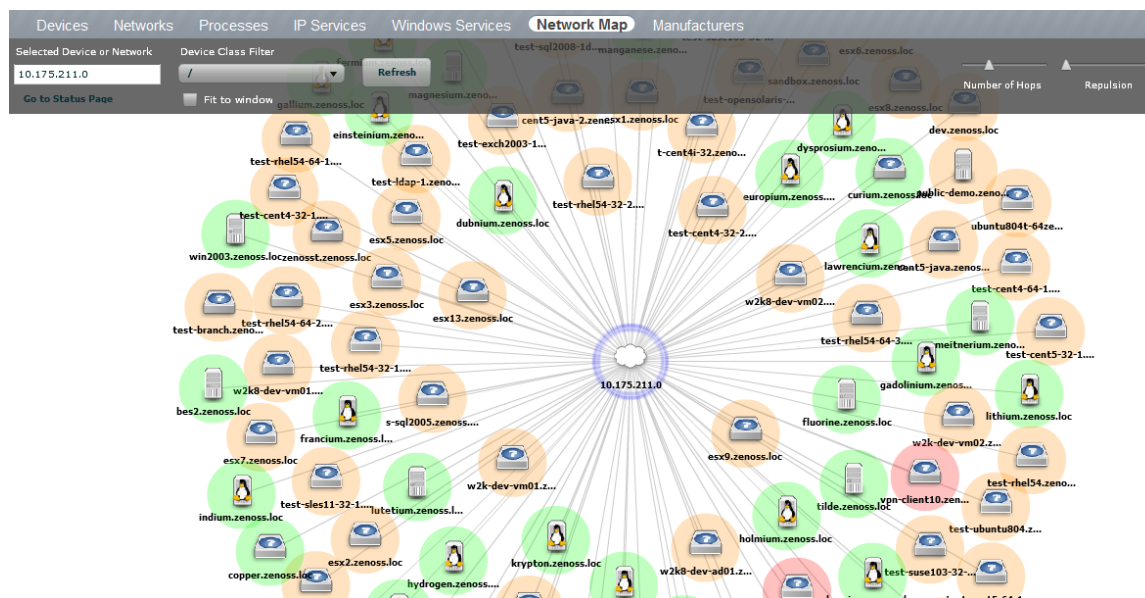

#### 2.1.4.1. Choosing the Network to Display

The network displayed is configured for each user. From user preferences, modify Network Map Start Object to indicate a network, and then click Save.

#### 2.1.4.2. Viewing Device and Network Details

Double-click a device or network icon in the map to focus on it. Focusing on a node:

- Centers it on the map
- Shows links from the node, based on the number of hops selected

Alternatively, you can type the name or IP address of a device or network in the Selected Device or Network field, and then click **Refresh** to focus on that node.

## Note

When you select a node, the network map displays only the links that are currently loaded into the map. It does not download and display new link data.

### 2.1.4.3. Loading Link Data

To load link data for a node:

1. Double-click the node on the map to focus on it, or enter the device name or IP address in the Selected Device or Network field.
2. Select the number of hops to download and display.
3. Click **Refresh**.

### 2.1.4.4. Filtering by Device Type

You can filter the devices that appear on the network map. To do this, select a filter from the Device Class Filter list of options. For example, to show only Linux devices on the map, select /Server/Linux from the list of options, and then click **Refresh**.

### 2.1.4.5. Adjusting Viewable Hops

You can adjust the number of hops that appear on the network map. Use the Number of Hops slider, which adjusts the number of hops from 1 to 4.

### 2.1.4.6. Adjusting the Network Map

Use the Repulsion slider to expand or contract the icons that appear on the map. Move the slider right to expand the icons, or left to contract them.

Select the Fit to Window option to bring all displayed icons into the viewable area.

### 2.1.4.7. Viewing Device or Network Details

To see detailed information about a device or network, select it in the map, and then click **Go to Status Page**.

## 2.2. Customizing the Dashboard

You can customize the Dashboard by:

- Selecting the portlets you want to monitor
- Arranging portlets
- Changing the Dashboard column layout

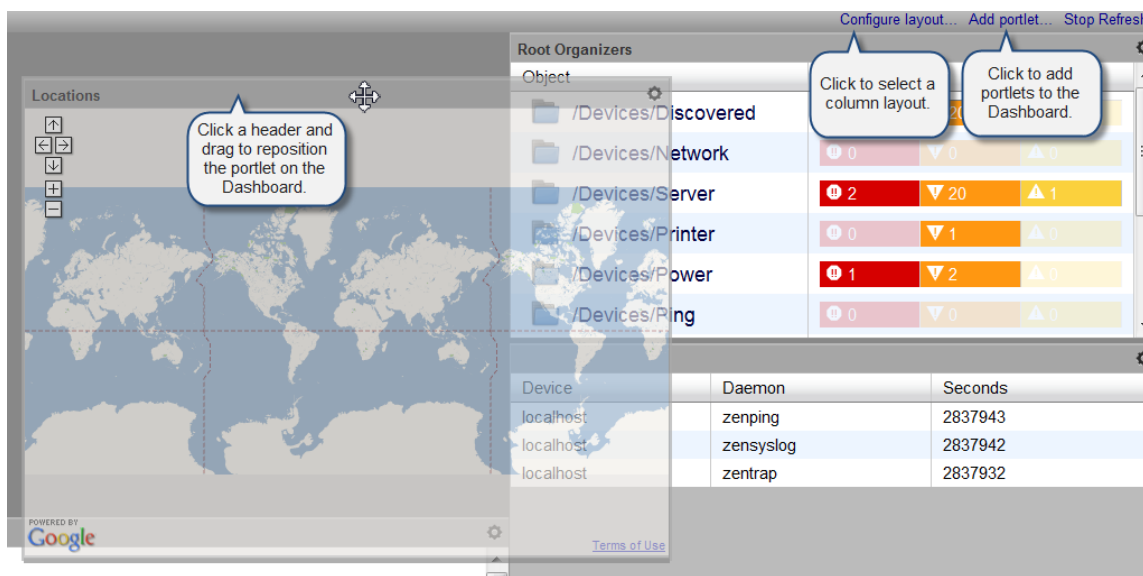
**Figure 2.7. Customize Dashboard**

### 2.2.1. Selecting Portlets

To add a portlet to the Dashboard:

1. Click **Add portlet** (located at the top right of the Dashboard main area).

The Add Portlet dialog appears.

2. Select a portlet.

The portlet appears at the top right of the Dashboard main area.

To remove a portlet from the Dashboard:

1. Click  in the top right corner of the portlet you want to remove.

The portlet expands to show its Settings area.

2. Click **Remove Portlet**.

### 2.2.2. Arranging Portlets

To arrange portlets, click the portlet header and drag the portlet to any location on the Dashboard. Other portlets rearrange depending on the location you drop it.

### 2.2.3. Changing the Dashboard Column Layout

You can change the layout of the Dashboard to one, two, or three-column displays. For two-column display, you can additionally choose a layout that offers columns of equal or varying widths.

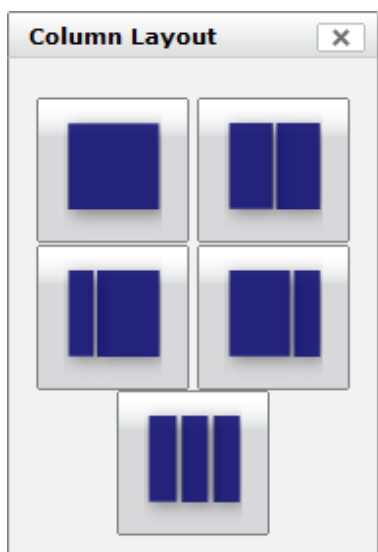
**Figure 2.8. Column Layout Dialog**

To change the Dashboard column layout:

1. Click Configure layout... (located at the top right of the Dashboard main area).

The Column Layout dialog appears.

2. Click to select your preferred column layout.

### Note

After selecting a new layout, you likely will need to rearrange the portlets on the Dashboard.

## 2.3. Search

You can search for devices in the system, by name or IP address.

A search input field appears at the top right of each page of the user interface. Typing text in this field triggers a search. You can enter partial word searches; for example, the keyword "test" matches "test123" and "test." Search results are limited to the top twenty-five matches.

## 2.4. Navigating the Event Console

The event console is the system's central nervous system, enabling you to view and manage events. It displays the repository of all events that are detected by the system.

To access the event console, click Event Console in the Navigation menu.

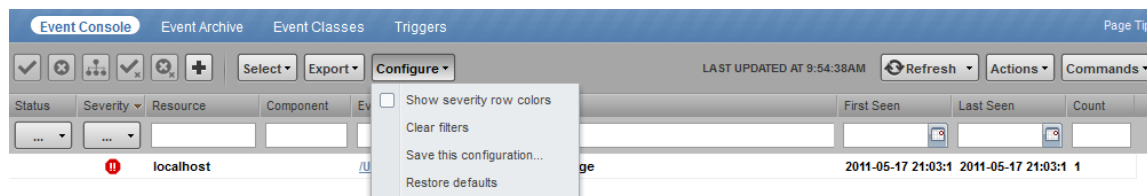
**Figure 2.9. Event Console**

### 2.4.1. Sorting and Filtering Events

You can sort and filter events that appear in the event console to customize your view.

You can sort events by any column that appears in the event console. To sort events, click a column header. Clicking the header toggles between ascending and descending sort order.

Filter options appear below each column header.

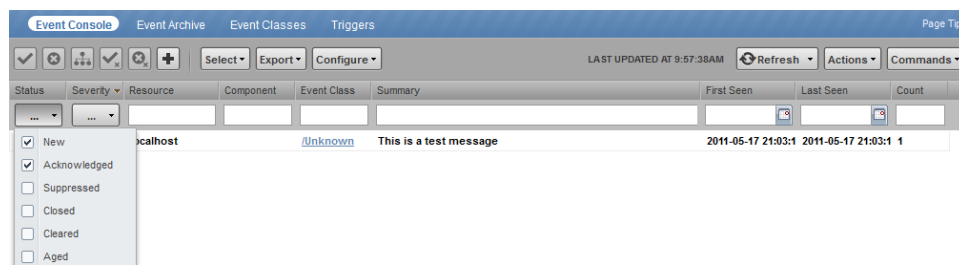
**Figure 2.10. Event Console Filter Options**

You can filter the events that appear in the list in several ways, depending on the field type:

- **Resource** - Enter a match value to limit the list.
- **Component** - Enter a match value to limit the list.
- **Event Class** - Enter a match value to limit the list.
- **First Seen** - Enter a value or use a date selection tool to limit the list.
- **Last Seen** - Enter a value or use a date selection tool to limit the list.
- **Count** - Enter a value to filter the list, as follows:
  - $N$  - Displays events with a count equal to  $N$ .
  - $:N$  - displays events with a count less than or equal to  $N$ .
  - $M:N$  - Displays events with a count between  $M$  and  $N$  (inclusive).



- *M*: - Displays events with a count greater than or equal to *M*.

To clear filters, select **Configure > Clear filters**.

You also can re-arrange the display order of columns in the event console. Click and drag column headers to change their display.

## 2.4.2. Saving a Custom View

You can save your custom event console view by bookmarking it for quick access later. To do this:

1. Select **Configure > Save this configuration**.

A dialog containing a link to the current view appears.

2. Click and drag the link to the bookmarks link on your browser's menu bar.

The system adds an Events link to your bookmarks list.

**Tip:** You may want to re-title the bookmark, particularly if you choose to save more than one event console view.

## 2.4.3. Refreshing the View

You can refresh the list of events manually or specify that they refresh automatically. To manually refresh the view, click **Refresh**. You can manually refresh at any time, even if you have an automatic refresh increment specified.

To configure automatic refresh, select one of the time increments from the Refresh list. By default, automatic refresh is enabled and set to refresh each minute.

**Figure 2.11. Automatic Refresh Selections**

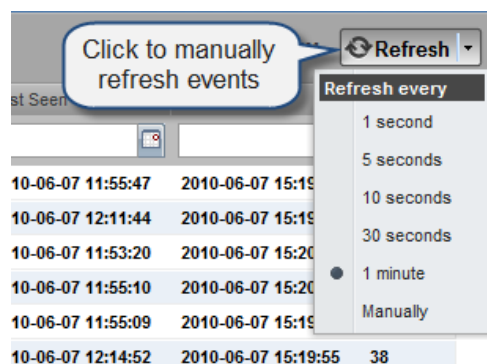

## 2.4.4. Viewing Event Details

You can view details for any event in the system. To view details, double-click an event row.

**Tip:** Do not double-click on or near the device (resource) name, component, or device class in the row. Doing this displays details about that entity, rather than information about the event.

The Event Detail area appears.

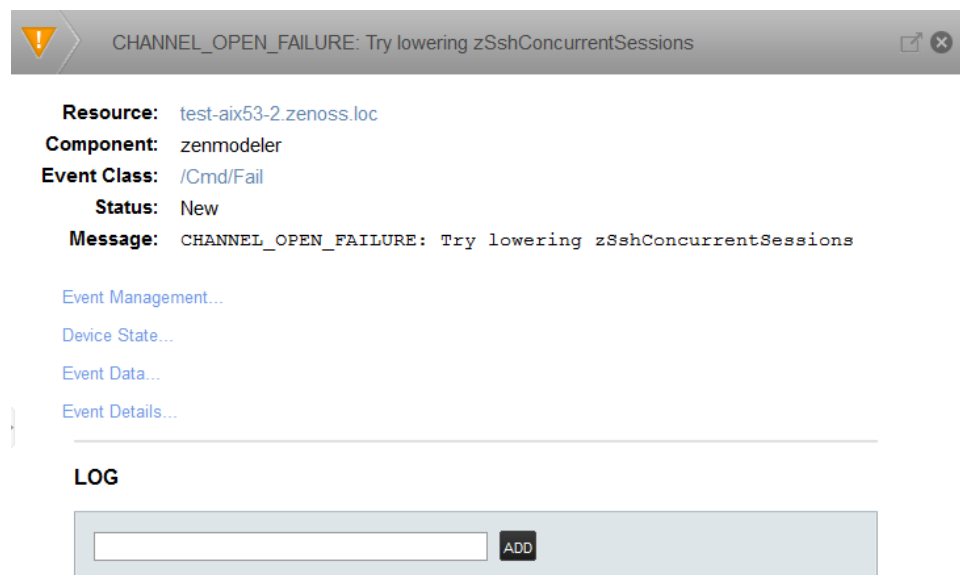
**Figure 2.12. Event Detail**

To see more information about the event, click Event Details.

You can use the Log field (located at the bottom of the area) to add specific information about the event. Enter details, and then click **Add**.

## 2.4.5. Selecting Events

To select one or more events in the list, you can:

- Click a row to select a single event
- Ctrl-Click rows to select multiple events, or Shift-Click to select a range of events
- Click Select to select events by status

## 2.4.6. Managing Events

You can manage events from the event console. After making a selection, you can:

- Acknowledge the event
- Close the event
- Reclassify the event, associating it with a specific event class
- Return the event to New status (revoke its Acknowledged status)
- Reopen the event

You also can add an event from the event console.

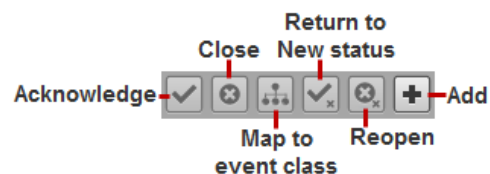
**Figure 2.13. Event Management Options**

## 2.5. Running Commands

Zenoss Core allows commands to be run through the Web-based user interface. You can run commands on a single device or on a group of devices.

The system includes several built-in commands, such as `ping` and `traceroute`.

To run commands from the user interface:

1. Select one or more devices from the Devices list.
2. Select a command from the Commands list of options.

The system runs the command. Command output appears on the screen.

**Figure 2.14. Command Output**

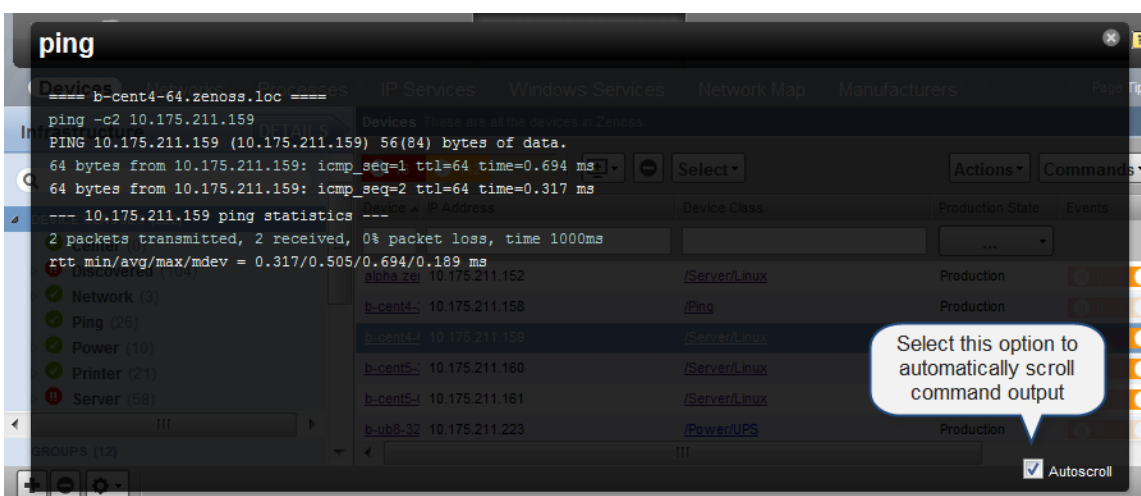

You can resize the command output window. You also can stop automatic scrolling by de-selecting the Autoscroll option at the bottom right corner of the output window.

## 2.6. Working with Triggers and Notifications

You can create *notifications* to send email or pages, create SNMP traps, or execute arbitrary commands in response to an event. Notifications also can be used to send SNMP traps to other management systems, and to execute arbitrary commands to drive other types of integration. How and when a notification is sent is determined by a *trigger*, which specifies a rule comprising a series of one or more conditions.

To set up a notification, you must:

- Create a trigger, selecting the rules that define it
- Create a notification, selecting one or more triggers that cause it to run
- Choose appropriate options and subscribers, depending on the notification type

Read the following sections to learn about:

- Setting up triggers and trigger permissions
- Setting system SMTP settings for notifications

- Setting up notifications and notification permissions

## 2.6.1. Working with Triggers

Setting up a trigger involves:

- Creating the trigger and the rules that define it
- Setting trigger permissions

### 2.6.1.1. Creating a Trigger

To create a trigger:

1. Select Events > Triggers from the Navigation menu.

the Triggers page appears. It displays all existing triggers, indicating whether each is enabled.

2. Click  (Add).

The Add Trigger dialog appears.

3. Enter a name for the trigger, and then click **Submit**.

The trigger is added to the list.

4. Double-click the trigger, or click Edit to open the Edit Trigger dialog.

**Figure 2.15. Edit Trigger**

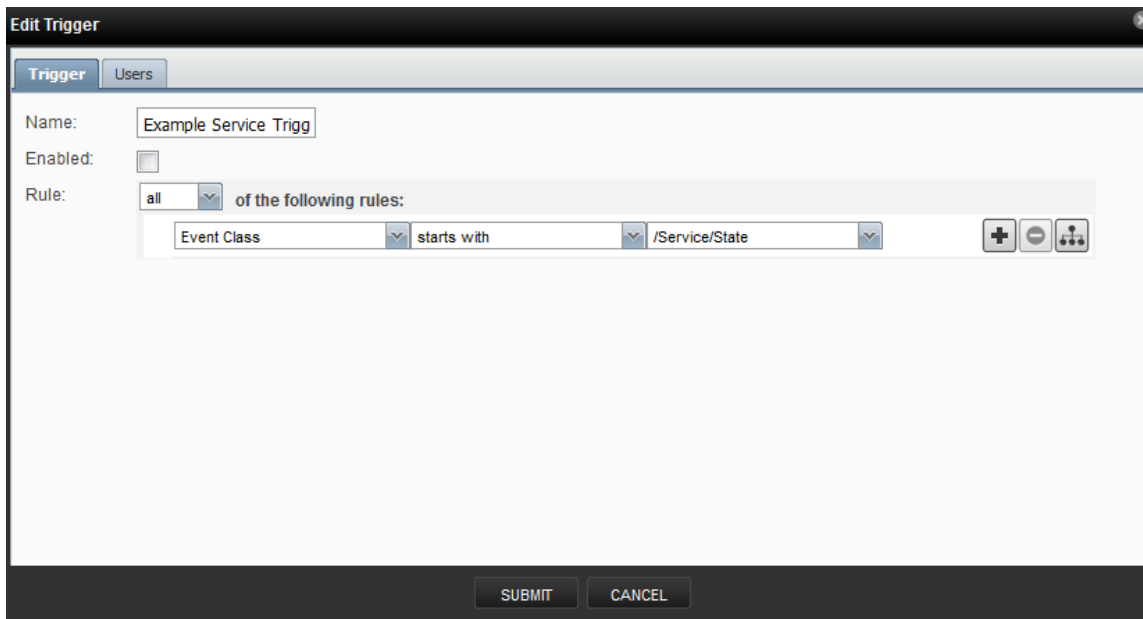

Enter information or make selections to define the trigger:

- **Enabled** - Select this option to enable the trigger.
- **Rule** - Define the rule comprising the trigger:

- Select All or Any from the list to specify whether a notification will be triggered based on all, or any one, of the trigger rules.
- Define the rule by making selections from each event field.

To add a rule to the trigger, click  (Add).

### 2.6.1.2. Setting Global Trigger Permissions

You can set global permissions for viewing, editing, and managing triggers. Global permissions are given to any user with "manage" permission, which includes:

- admin, Manager, and ZenManager Zenoss Core roles
- Trigger owner

Edit global permissions from the Users tab on the Edit Trigger dialog.

Global options are:

- **Everyone can view** - Provides global view permission.
- **Everyone can edit content** - Provides global update permission.
- **Everyone can manage users** - Provides global manage permission.

**Figure 2.16. Edit Trigger - Users Tab**

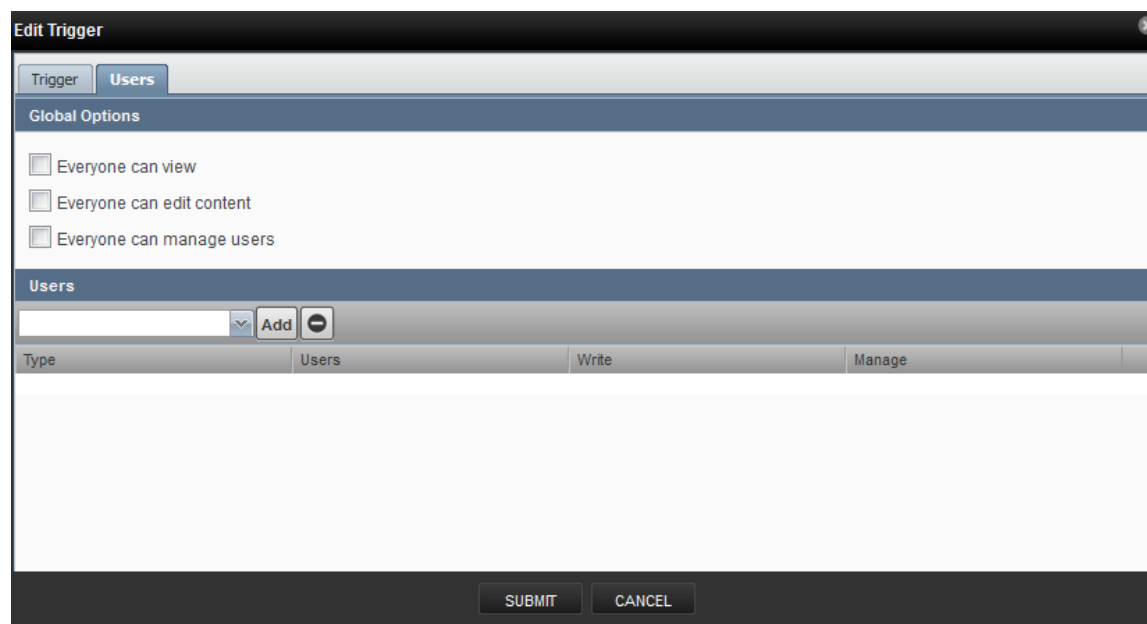

### 2.6.1.3. Setting Individual Trigger Permissions

You can grant permissions to individual users. For each user added, you can select:

- **Write** - Select this option to grant the user permission to update the trigger
- **Manage** - Select this option to grant the user permission to manage the trigger.

## 2.6.2. Working with Notifications

Setting up a notification involves:

- Creating the notification
- Defining notification content (for email- or page-type notifications)
- Defining the SNMP trap host (for SNMP trap-type notifications)
- Defining commands to run (for command-type notifications)
- Setting notification permissions
- Setting up notification schedules

### 2.6.2.1. Creating or Editing a Notification

To create or edit a notification:

1. Select Events > Triggers from the Navigation menu.
2. Select Notifications in the left panel.

The Notifications page appears.

**Figure 2.17. Notifications**

Enabled	Id	Trigger	Action	Subscribers
Yes	RemodeHostsOnMigrat		command	0
Yes	RemodeEndpoint		command	0
No	MSExchangeISWMTotals		command	0
Yes	RemodeHostByRef		command	0
Yes	RemodeOnMigration		command	0
Yes	rancid-run		command	0
No	ExampleServiceEmailNo	Example Service Trigge	email	0

The Notification Subscriptions area lists all defined notifications. For each notification, the area indicates whether the notification is enabled (Yes or No), the Action associated with the notification, and the number of notification subscribers.

To edit a notification, double-click it; or select it, and then click the Action menu.

To create a notification:

- a. click  (Add).

The Add Notification dialog appears.

- b. Enter a name for the notification.
- c. Select an Action associated with the notification:

- **Command** - Allows the system to run arbitrary shell commands when events occur. Common uses of a Command notification include:
  - *Auto-remediation of events.* You can use SSH to remotely restart services on a UNIX system when they fail, or winexe to do the same for Windows services.
  - *Integration with external systems.* This includes opening tickets in your incident management system.
  - *Extending alerting mechanisms.* Zenoss Core supports email and pagers as alerting mechanisms "out of the box" through normal notifications.
- **Email** - Sends an HTML or text email message to authorized subscribers when an event matches a trigger rule.
- **Page** - Pages authorized subscribers when an event matches a trigger rule.
- **SNMP Trap** - Sends an SNMP trap when an event matches a trigger rule.

d. Click **Submit**.

The Edit Notification Subscription dialog appears.

**Figure 2.18. Edit Notification Subscription**

The screenshot shows the 'Edit Notification Subscription' dialog box. It has three tabs: 'Notification', 'Content', and 'Subscribers'. The 'Notification' tab is selected. The settings are as follows:

- Enabled:**
- Send Clear:**
- Send only on Initial Occurrence?:**
- Delay (seconds):**
- Repeat (seconds):**

Below the settings is a 'Triggers' section with a dropdown menu, an 'Add' button, and a minus button. A list of triggers is shown below, with 'Example Service Trigger' selected. At the bottom are 'SUBMIT' and 'CANCEL' buttons.

On the Notification tab, you can select or set:

- **Enabled** - Select this option to enable the notification.
- **Send Clear** - Specify to send a notification when the problem has been resolved by a clear event.
- **Send only on Initial Occurrence** - Select this option to send the notification only on the first occurrence of the trigger.

- **Delay (seconds)** - Specify the minimum age (in seconds) of an event before the notification will be executed. You might want to set a delay to prevent notifications being sent for transient problems, or to prevent multiple notifications being sent for the same problem.

For example, if you have five events that come in and match the trigger in 45 seconds, specifying a delay of 60 seconds will ensure that only one notification is sent. Additionally, if you have an event that matches the trigger at 15 seconds and is later cleared by another event at 45 seconds, a delay of 60 seconds will prevent notifications being sent.

- **Repeat (seconds)** - Specify how often to repeat the notification until the event that triggered it is resolved.

### 2.6.2.2. Defining Notification Content

To define notification content, click the **Content** tab of the notification.

For email-type notifications, you can use the default configuration for the following fields, or customize them to your needs:

- **Body Content Type** - Select HTML or text.
- **Message (Subject) Format** - Sent as the subject of the notification.
- **Body Format** - Sent in the notification.
- **Clear Subject Format** - Sent when a notification clears.
- **Clear Body Format** - Sent when a notification clears.



**Figure 2.19. Define Notification Content (Email)**

**Edit Notification - ExampleServiceEmailNotification (email)**

Notification | **Content** | Subscribers

Body Content Type:

Message (Subject) Format:

Body Format:

```

Device: ${evt/device}
Component: ${ext/component}
Severity: ${evt/severity}
Time: ${ext/lastSeen}
Message:
${evt/message}
<a tal:attributes="href urls/eventUrl">Event Detail</a>
<a tal:attributes="href urls/ackUrl">Acknowledge</a>
<a tal:attributes="href urls/closeUrl">Close</a>
<a tal:attributes="href urls/eventsUrl">Device Events</a>
The following events are causes of this event:
<tal:block tal:repeat="item esa/causes">
Impact Chain: ${item/impactChain}
Device: ${item/evt/device}
Component: ${item/evt/component}
Severity: ${item/evt/severity}
Time: ${item/evt/lastSeen}
Message:
${item/evt/message}
<a tal:attributes="href item/urls/eventUrl">Event Detail</a>
<a tal:attributes="href item/urls/ackUrl">Acknowledge</a>
<a tal:attributes="href item/urls/closeUrl">Close</a>
<a tal:attributes="href item/urls/eventsUrl">Device
Events</a>
</tal:block>

```

Clear Message (Subject) Format:

Body Format:

```

Event: '${ext/summary}'
Cleared by: '${ext/id}'
At: ${ext/stateChange}
Device: ${ext/device}
Component: ${ext/component}
Severity: ${ext/severity}
Message:
${ext/message}
<a href="${urls/reopenUrl}">Reopen</a>

```

SUBMIT CANCEL

For page-type notifications, you can use the default configuration for the following fields, or customize them to your needs:

- **Message (Subject) Format** - Sent as the subject of the notification.
- **Clear Message Format** - Sent when a notification clears.

**Figure 2.20. Edit Notification Content (Page)**

Edit Notification - ExamplePageNotification (page)

Notification   **Content**   Subscribers

Message (Subject) Format:

Clear Message (Subject) Format:

SUBMIT   CANCEL

### 2.6.2.2.1. Notification Content Variables

Within the body of your email, page, and command notifications, you can specify information about the current event, in the form:

```
'${objectname/objectattribute}'
```

#### Note

Do not escape event command messages and event summaries. For example, write this command as: `${evt/summary}` (rather than `echo '${evt/summary}'`).

Object names may be `evt`, `evtSummary`, or `urls`; or for clearing event context, `clearEvt` and `clearEventSummary`. For each object name, the following lists show valid attributes (for example, `'${evt/DevicePriority}'`):

- `evt/` and `clearEvt/`
  - `DevicePriority`
  - `agent`
  - `clearid`
  - `component`
  - `count`
  - `created`
  - `dedupid`

- device
- eventClass
- eventClassKey
- eventGroup
- eventKey
- eventState
- evid
- facility
- firstTime
- ipAddress
- lastTime
- manager
- message
- ntevid
- ownerid
- priority
- prodState
- severity
- stateChange
- status
- summary

### **Note**

The `message` and `summary` names are, by default, wrapped in double quotes in event commands.

- `eventSummary/` and `clearEventSummary/`
  - `uuid`
  - `occurrence`
  - `status`
  - `first_seen_time`
  - `status_change_time`

- last\_seen\_time
- count
- current\_user\_uuid
- current\_user\_name
- cleared\_by\_event\_uuid
- notes
- update\_time
- created\_time
- fingerprint
- event\_class
- event\_class\_key
- event\_class\_mapping\_uuid
- actor
- summary
- message
- severity
- event\_key
- event\_group
- agent
- syslog\_priority
- syslog\_facility
- nt\_event\_code
- monitor
- tags
- urls/
  - ackUrl
  - closeUrl
  - reopenUrl
  - eventUrl

- eventsUrl

ZenPacks also can define additional notification actions, and can extend the context available to notifications to add additional objects or attributes.

### 2.6.2.3. Defining the SNMP Trap Host

Figure 2.21. SNMP Trap Notification (Content)

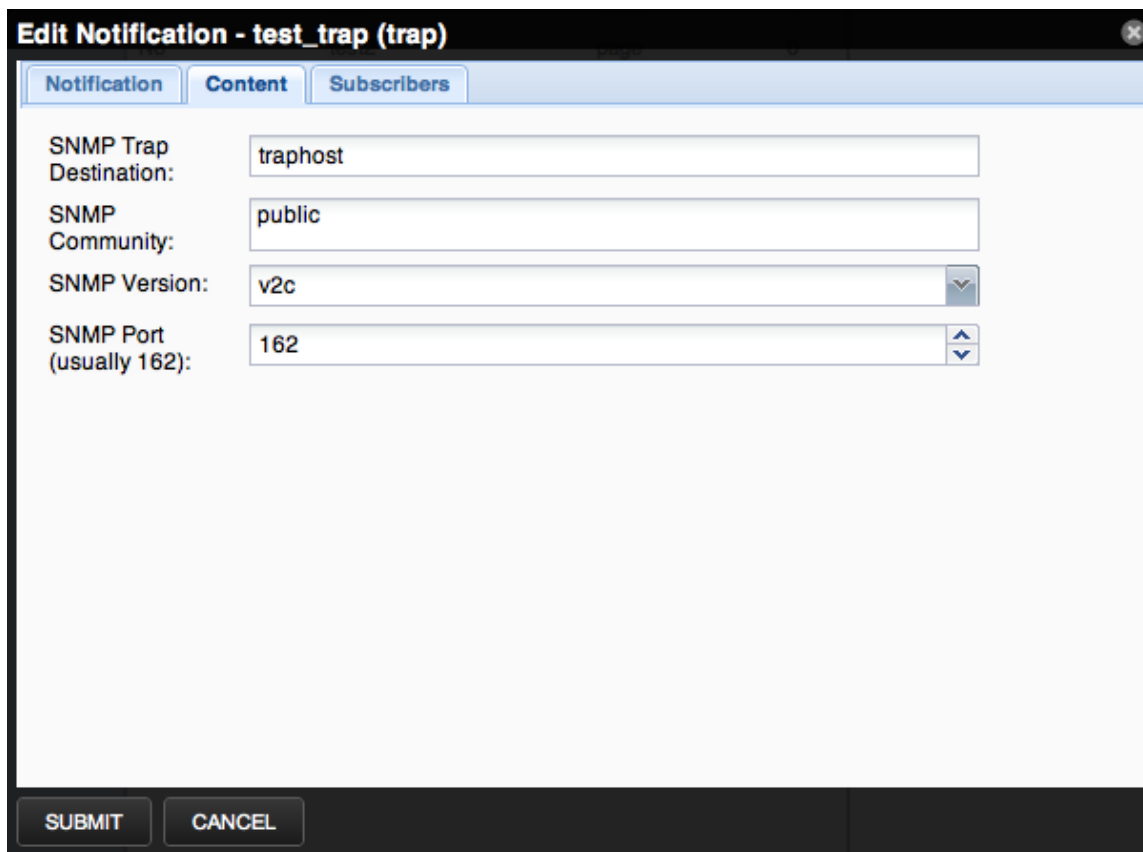

The screenshot shows a web-based configuration window titled "Edit Notification - test\_trap (trap)". It has three tabs: "Notification", "Content", and "Subscribers". The "Content" tab is selected. The form contains the following fields:

- SNMP Trap Destination: traphost
- SNMP Community: public
- SNMP Version: v2c (dropdown menu)
- SNMP Port (usually 162): 162 (dropdown menu)

At the bottom of the window are two buttons: "SUBMIT" and "CANCEL".

For SNMP trap-type notifications, enter information or make selections on the Content tab of the notification:

- **SNMP Trap Destination** - Specify the host name or IP address where the trap should be sent.
- **SNMP Community** - Specify the SNMP community. By default, this is public.
- **SNMP Version** - Select v2c (default) or v1.
- **SNMP Port** - Specify the SNMP port. Typically, this is 162.

SNMP traps sent as a result of this notification are defined in the `ZENOSS-MIB` file. You can find this MIB file on any Zenoss Core server at `$ZENHOME/share/mibs/site/ZENOSS-MIB.txt`.

### 2.6.2.4. Defining Commands to Run

For Command-type notifications, you must specify the command to run when configured triggers are matched. Do this on the Content tab of the notification. Configure these fields:

- **Command Timeout** - By default, 60 seconds.
- **Command** - Command to run when a trigger is matched.
- **Clear Command** - Optional command to run when the triggering event clears.
- **Environment Variables** - Enter one or more environment variables, consisting of of *Name=Value* pairs. Environment variables must be separated by a ; (semi-colon).

**Figure 2.22. Edit Notification Content (Command)**

The screenshot shows a dialog box titled "Edit Notification - MExchange\SWMTTotal16MBFreeBlocks (command)". It has three tabs: "Notification", "Content", and "Subscribers". The "Content" tab is selected. The form contains three input fields: "Command Timeout (seconds)" with the value "60", "Command" with the value "winexe --user {} --password={} //{} 'restart?;", and "Clear Command" which is empty. At the bottom of the dialog are "SUBMIT" and "CANCEL" buttons.

### 2.6.2.5. Setting Global Notification Permissions

By establishing permissions, you can control which users have the ability to view, manage, and update notifications. Permissions are granted based on the user's assigned role. The following table lists account roles and their associated notification permissions:

Role	Permissions
admin, Manager, ZenManager	Users assigned the Zenoss Core admin, Manager, or ZenManager roles can view, update, and manage any notification.
notification owner	When a user creates a notification, he is designated the owner of that notification. During the life of the notification, the owner can view, update, and manage it.
all other users (including those assigned the ZenUser role)	Must be specifically granted permissions through the interface to view, edit, or manage notifications.

You can set global permissions for viewing, updating and managing a notification. Global permissions are given to any user with "manage" permission, which includes:

- admin, Manager, and ZenManager Zenoss Core roles

- Notification owner

Edit global permissions from the Subscribers tab on the Edit Notification Subscription panel.

Global options are:

- **Everyone can view** - Provides global view permission.
- **Everyone can edit content** - Provides global update permission.
- **Everyone can manage subscriptions** - Provides global manage permission.

Permission checks occur when the data is sent to the browser and when any action occurs. To determine where a user can make modifications to a particular tab, permission checks are performed on global roles, then managerial roles, and then individual roles. Any role that provides the required permission will allow that permission's associated behavior.

**Figure 2.23. Edit Notification Subscription**

Type	Subscribers	Write	Manage
user	admin (User)	<input type="checkbox"/>	<input type="checkbox"/>

### 2.6.2.6. Setting Individual Notification Permissions

You can grant permissions to individual users or groups. For each user or group added, you can select:

- **Write** - Select this option to grant the user or group permission to update the notification.
- **Manage** - Select this option to grant the user or group permission to manage the notification.

You can manually enter in the name of a user or group, or select one from the list of options.

### 2.6.2.7. Setting Up Notification Schedules

You can establish one or more notification schedules for each defined notification. To set up a schedule:

1. Select the notification in the Notifications area.
2. Click Add in the Notification Schedules area.

The Add Schedule Window dialog appears.

**Figure 2.24. Add Notification Schedule**

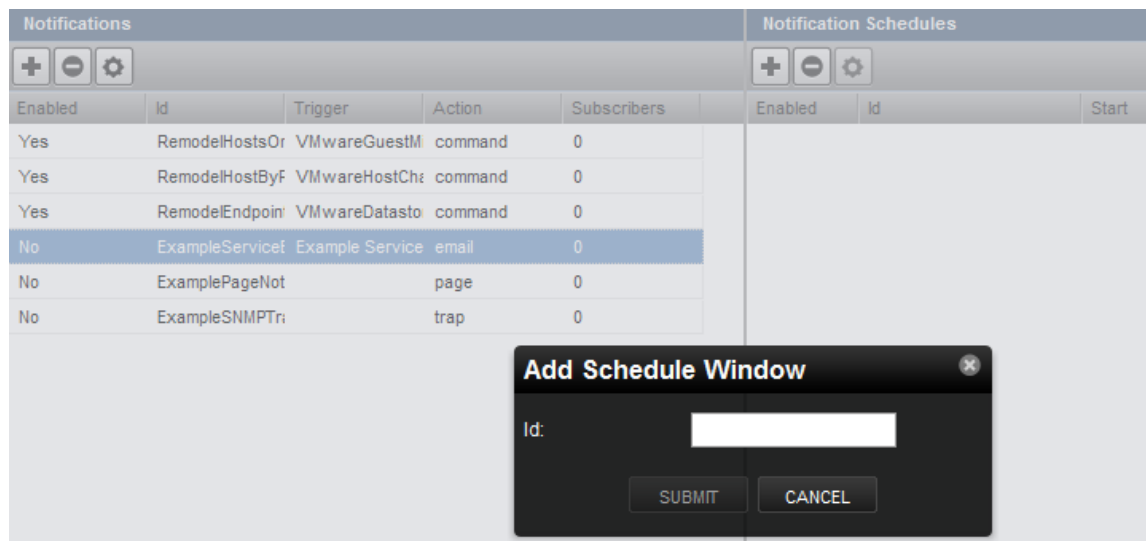

3. Enter a schedule ID, and then click **Submit**.
4. Double-click the newly added schedule to edit it. Select or enter values for the following fields:
  - **Enabled** - Select to enable the schedule. By default, this schedule is not enabled.
  - **Start Date** - Enter or select a start date for the schedule.
  - **Start Time** - Enter or Select a start time for the schedule.
  - **Repeat** - Select a schedule repeat value: Never, Daily, Every Weekday, Weekly, Monthly, or First Sunday of the Month.
  - **Duration (Minutes)** - Enter a schedule duration, which is the period of time that the notification window is active. If a notification has notification windows specified, then notifications are sent only if one of the windows is active when the notification is received.
5. Click **Submit**.

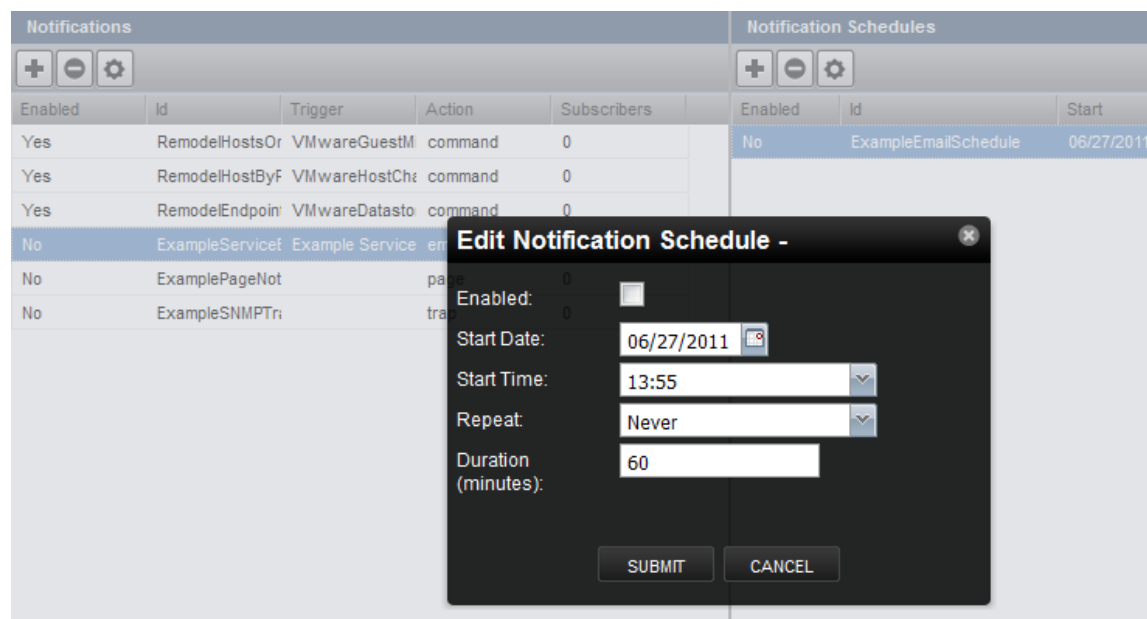

**Figure 2.25. Edit Notification Schedule**

## 2.7. Advanced User Interface Configuration

To access advanced user interface configuration options, select **Advanced > Settings**, and then select **User Interface** in the left panel. This area lets you configure options such as how data loads, how much data is loaded, and filter and search options.

Select options or enter information:

- **Enable Live Search** - Disable this option to turn off the live search feature. By default, live search is enabled.
- **Enable Incremental Tree Loading on the Infrastructure Page** - Enable this option to load the infrastructure tree one node at a time. If disabled (the default), then the infrastructure tree is loaded all at once. You might enable this option if you have a complex hierarchy of organizers and device classes and want to improve your UI load response time.
- **Enable Tree Filters** - If disabled, then tree filters (the text input area that allows you to filter the information displayed) are hidden on all pages. This option is enabled by default.
- **Device Grid Buffer Size** - Specify the number of device data rows to fetch from the server for each buffer request. The default buffer size is 100 rows.
- **Component Grid Buffer Size** - Specify the number of component data rows to fetch from the server for each buffer request. The default buffer size is 50 rows.
- **Event Console Buffer Size** - Specify the number of event rows to fetch from the server for each buffer request. The default buffer size is 200 rows.
- **Device Move Job Threshold** - Specify the limit at which devices are moved immediately. If the number of devices to be moved exceeds this threshold, then the move occurs in a job; otherwise, they are moved immediately. The default value is 5 devices.

When complete, click **Save** to save your changes.

---

# Chapter 3. Adding, Discovering and Modeling Devices

Modeling is the process by which Zenoss Core:

- Populates the device database
- Collects information about the devices in the system (such as operating system type or file system capacity)

The system models devices when they are added to the database, either manually or through the discovery process.

Read this chapter for more information about:

- Adding devices
- Discovering, classifying, and authenticating devices
- Modeling devices by using SNMP, SSH/COMMAND, and Port Scan
- Working with modeler plugins
- Debugging the modeling process

## 3.1. Adding Devices

You can manually add single or multiple devices.

### 3.1.1. Add a Single Device

Follow these steps to add a single device:

1. From the Navigation menu, select Infrastructure.

The Devices page appears.

2. Select Add a Single Device from  (Add Devices).

The Add a Single Device dialog appears.

**Figure 3.1. Add a Single Device**

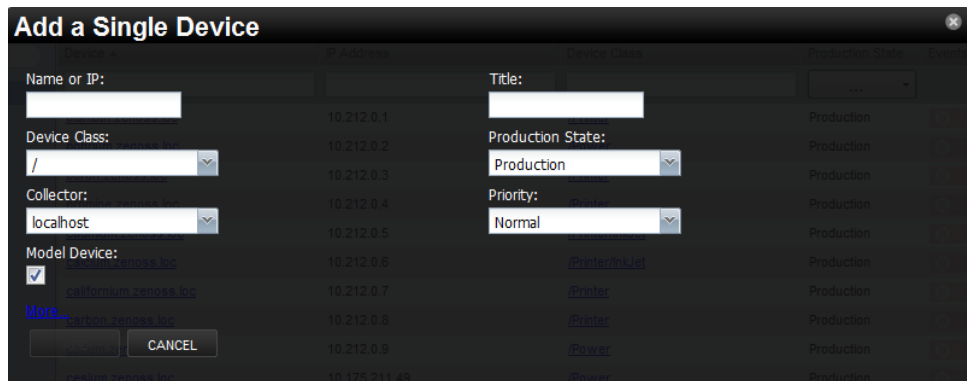

3. Enter information or make selections to add the device:
  - **Name or IP** - Enter the network (DNS) name or IP address of the device.
  - **Device Class** - Select a device class to which this device will belong. For example, if the new device is a Windows server, then select /Server/Windows.
  - **Collector** - By default, this is localhost. Select a collector for the device.
  - **Model** - By default, this option is selected. De-select this option if you do not want the device to be modeled when it is added.
4. Optionally, click More to display additional fields. From the expanded page, you can:
  - Enter device-specific details
  - Edit SNMP settings
  - Set hardware and operating system information
  - Add device comments

### Note

Name or IP, Device Class, and Model are the only required selections when adding a device. You may want to continue (click **Add**) without additional information or selections, as information you add may conflict with information the system discovers about the device.

An exception is if you are adding a Cisco router in a device class other than /Network. In this case, before adding the device you should set the value of the zlfDescription configuration property to True. This will give you additional information about Cisco routers. By default, this option is set to True for the /Network class.

5. Click **Add**.

### Note

You can view the Add Device job in progress. Click **View Job Log** in the notification that appears when you add the device.

When the job completes, the device is added in the selected device class.

## 3.1.2. Add Multiple Devices

Follow these steps to manually add multiple devices:

1. From the Navigation menu, select Infrastructure.

The Devices page appears.

2. Select Add Multiple Devices from  (Add Devices).

The Add Devices panel appears.

3. For each device you want to add, enter the fully qualified domain name or IP address of a device on your network.

4. In the Details area, select a device type from the list. If your device type is not listed, then use the default selection. (You can choose a different device type after adding the device.)
5. Enter the appropriate credentials used to authenticate against the device.
6. If you want to add more than one device, click +. Enter one hostname or IP address on each line. Each device can have only one set of associated credentials.
7. To add the devices, click **Submit**. Zenoss Core models the devices in the background.

## 3.2. Discovering Devices

You can provide network or IP address range information so that the system can discover your devices.

Follow these steps to discover devices:

1. From the Navigation menu, select Infrastructure.

The Devices page appears.

2. Select Add Multiple Devices from  (Add Devices).

The Add Devices panel appears.

3. Select the **Autodiscover devices** option.

**Figure 3.2. Add Multiple Devices (Discover)**

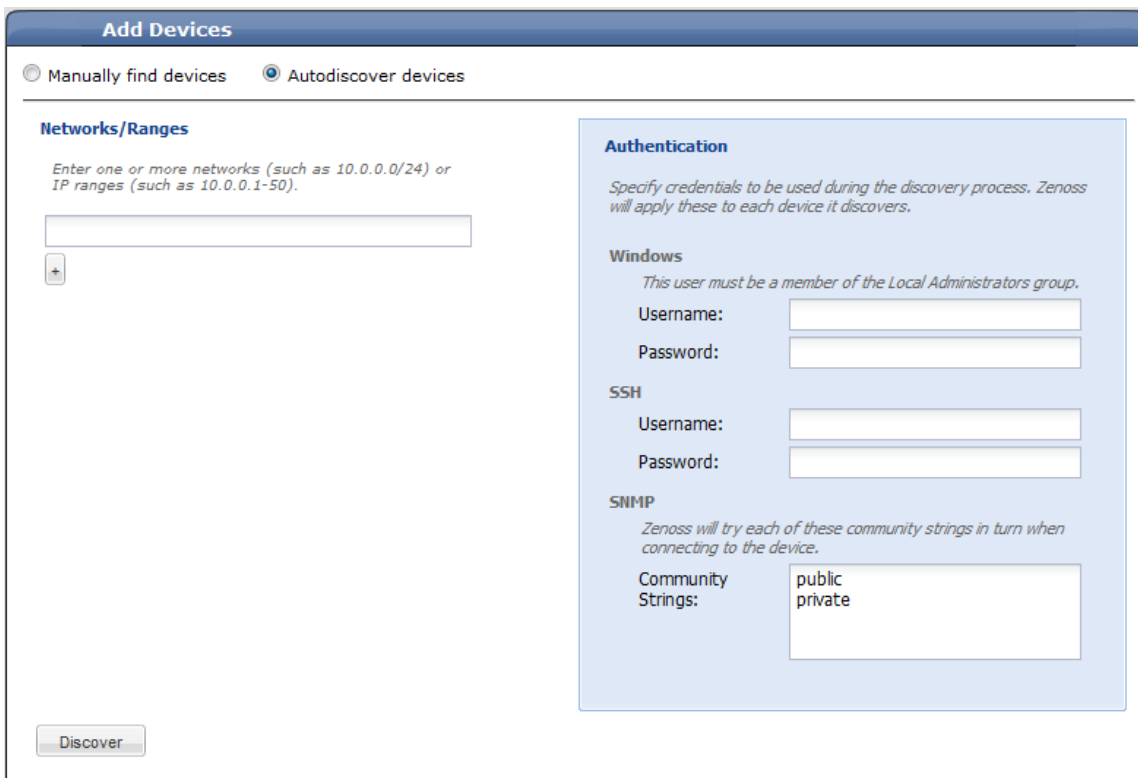

The screenshot shows the 'Add Devices' web interface. At the top, there are two radio buttons: 'Manually find devices' (unselected) and 'Autodiscover devices' (selected). Below this, the 'Networks/Ranges' section has a text input field with a '+' icon below it. The 'Authentication' section is highlighted in light blue and contains three sub-sections: 'Windows' with 'Username' and 'Password' fields, 'SSH' with 'Username' and 'Password' fields, and 'SNMP' with a 'Community Strings' field containing 'public' and 'private' on separate lines. A 'Discover' button is located at the bottom left of the form.

4. For each network or IP range in which you want Zenoss Core to discover devices, enter an address or range. For example, you might enter a network address in CIDR notation:

10.175.211.0/24

or a range of IP addresses:

10.175.211.1-50

## Note

Trying to add a /16 or /8 network can take a very long time, and may have unintended consequences.

5. If you want to enter multiple addresses or ranges, click +. For each network, you must enter a netmask or IP range.
6. For each network or IP range, specify the Windows, SSH, or SNMP credentials you want Zenoss Core to use on the devices it discovers. You can enter only one of each. Zenoss Core will attempt to use the same credentials on each device it discovers within the networks or IP ranges specified, but will not try to automatically classify the devices.
7. Click **Discover**.

The discovery process iterates through every IP address in the networks and IP ranges you specify, adding each device that responds to a ping request. Further, the process adds information to any device that responds to an SNMP, WMI, or SSH request.

Zenoss Core places discovered routers in the device path /Network/Router. Devices are placed in the /Discovered device class.

### 3.2.1. Classifying Discovered Devices

Once discovery is complete, you must move discovered devices (placed, by default, in the /Discovered class) to an appropriate device class in the hierarchy. Moving devices to their correct hierarchy location makes it possible for monitoring to begin.

Servers are organized by operating system. If the system discovers Windows devices, for example, you might choose to relocate them to /Server/Windows. Similarly, you might choose to classify discovered Linux devices in /Server/Linux (if you want to monitor and model using SNMP), or /Server/SSH/Linux (if you want to monitor and model using SSH).

To classify discovered devices:

1. Select one or more discovered devices (highlight one or more rows) in the device list.
2. Drag the selected devices to the new device class in the tree view.

**Figure 3.3. Classifying Discovered Devices**

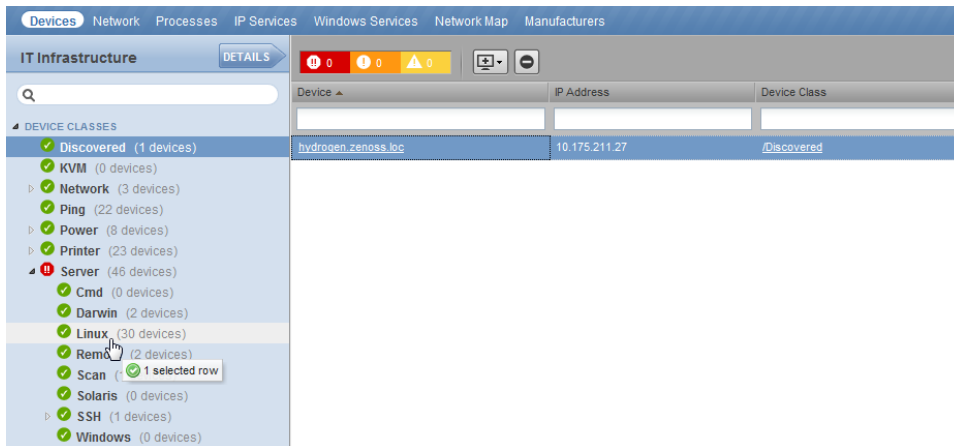

The Move Devices dialog appears.

3. Click **OK**.

The list of devices refreshes, and the devices now appear in the newly selected class.

### 3.2.2. Updating Device Authentication Details

For each device added to the database and set to its proper device class, the system may require additional or different authentication information before it can gather device information and monitor the device.

For example, for a device in the /Server/Windows class, you must supply your Windows user name and password before the system can monitor the device. To do this:

1. Click a device name in the devices list.

The Device summary page appears.

2. Select Configuration Properties from the left panel.
3. Double-click the zWinUser configuration property to display the Edit Config Property dialog.
4. Enter your Windows user name in the Value field, and then click **Submit**.
5. Double-click the zWinPassword configuration property to display the Edit Config Property dialog.
6. Enter your Windows password in the Value field, and then click **Submit**.

Similarly, for a device in the /Server/SSH/GenericLinux class, you must supply your SSH user name and password. Set these values in the device's zCommandUsername and zCommandPassword configuration properties.

#### Tip

After making changes, you should remodel the device to ensure the authentication changes are valid.

### 3.2.3. Adding Information to a Device Record

You may want to add details about a discovered device.

To add information:

1. Click a device name in the devices list.

The Device overview page appears.

2. You can select values to change, or click the "edit" link adjacent to a label to edit that value. Enter or change information in one or more areas, and then click **Save** to save your changes.

## 3.3. Modeling Devices

To model devices, the system can use:

- SNMP
- SSH
- WMI
- Telnet

The modeling method you select depends on your environment, and on the types of devices you want to model and monitor.

By default the system remodels each known device every 720 minutes (12 hours).

### Tip

You can change the frequency with which devices are remodeled. Edit the value of the Modeler Cycle Interval in the collector's configuration.

For larger deployments, modeling frequency may impact performance. In such environments, you should stop the ZenModeler daemon and run the modeling process once daily from a cron job.

### 3.3.1. Modeling Devices Using SNMP

Read this section for information about the methods Zenoss Core uses to model devices using SNMP.

#### 3.3.1.1. Testing to See if a Device is Running SNMP

To test whether a device is running SNMP, run this command:

```
$ snmpwalk -v1 -c communityString DeviceID system
```

If this command does not time out, then SNMP is installed and working correctly.

#### 3.3.1.2. Configuring Windows Devices to Provide Data Through SNMP

By default, Windows may not have SNMP installed. To install SNMP on your particular version of Windows, please refer to the Microsoft documentation.

After setting up and configuring the SNMP service, you must set the `zSnmpCommunity` string in Zenoss Core to match, to obtain SNMP data.

If you want processor and memory monitoring, install SNMP-Informant on the device. Go to <http://www.snmp-informant.com> and download SNMP for Windows.

To collect Windows event logs or log files from a Windows box using syslog, you can use the SyslogAgent Windows add-on, available from:

<http://syslogserver.com/syslogagent.html>

### 3.3.1.3. Configuring Linux Devices to Provide Data Through SNMP

To configure a Linux machine for monitoring, it must have SNMP installed. A good Linux SNMP application is net-snmp. Download, install, and configure net-snmp to then use SNMP to monitor Linux devices.

## 3.3.2. Modeling Devices Using SSH/COMMAND

You can gather additional information by running commands on the remote device and interpreting the results. This provides a more scalable and flexible way to gather information that may not be available through any other means.

Each built-in modeling command plugin is differentiated by the platform on which it runs. To determine the platform for the device you want to model, run the **uname** command in a shell on the device.

To model a device using command plugins, first add the device by using the protocol "none," and then choose the plugins you want to apply:

1. From the Navigation menu, select Infrastructure.
2. Select Add a Single Device from  (Add Devices).
3. Enter values for Name or IP and Device Class.
4. De-select the Model Device option.
5. Click **Add**.
6. After adding the device, select the device name in the devices list.

The Device summary page appears.

7. In the left panel, select Configuration Properties.
8. If necessary, set the values of the zCommandUsername and zCommandPassword configuration properties to the user name and password of the device (or set up authentication by using RSA/DSA keys.)

### Note

If using RSA keys for a device or device class, change the value of the zKeyPath configuration property to:

```
~/ .ssh/id_rsa
```

9. In the left panel, select Modeler Plugins.

The list of plugins appears. The left column displays available plugins; the right column shows those currently selected.

10. Select zenoss.cmd.uname from the Available list, and then use the right arrow control to move it to the Selected list on the right. Use the controls to place it at the top of the list.



**Figure 3.4. Add Plugin**

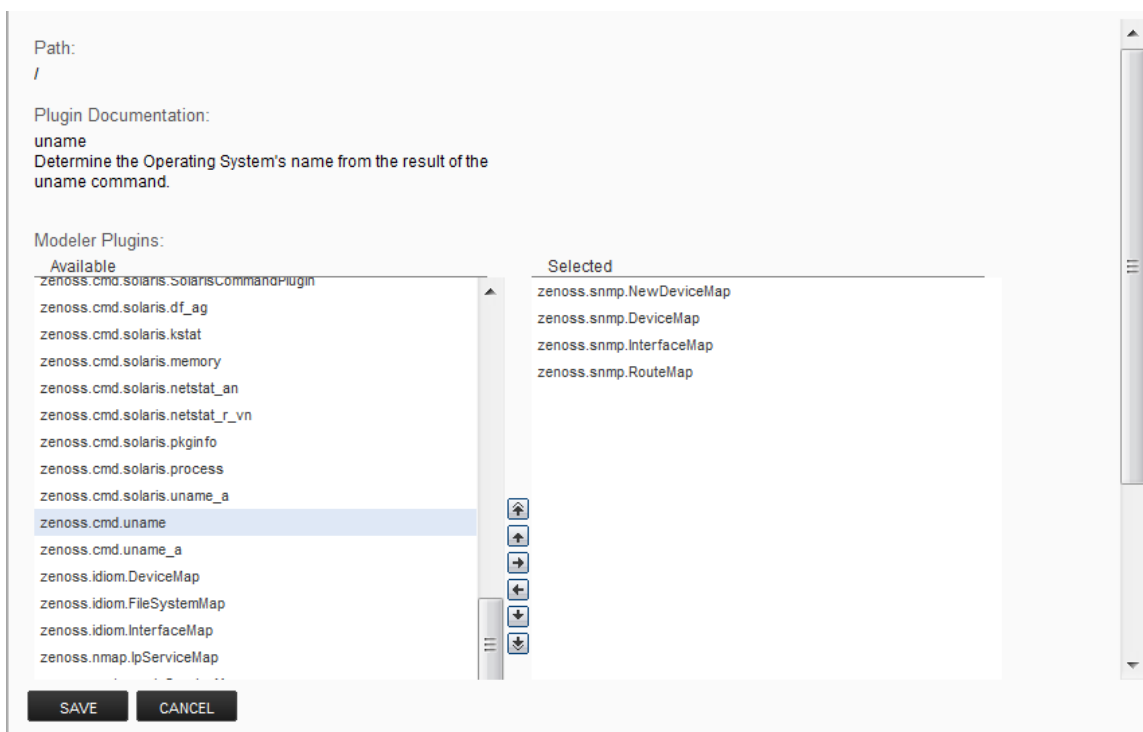

11. Use the left arrow control to move the other Selected plugins from the Selected list to the Available list.

12. Click **Save**.

13. Remodel the device.

### 3.3.2.1. Using Device Class to Monitor Devices Using SSH

The `/Server/Command` device class is an example configuration for modeling and monitoring devices using SSH. The `zCollectorPlugins` have been modified (see the section titled "Modeling Using SSH/Command"), and the device, file system, and Ethernet interface templates used to gather data over SSH have been created. You can use this device class as a reference for your own configuration; or, if you have a device that needs to be modeled or monitored via SSH/Command, you can place it in this device class to use the pre-configured templates and configuration properties. You also must set the `zCommandUsername` and `zCommandPassword` configuration properties to the appropriate SSH login information for each device.

### 3.3.3. Modeling Devices Using Port Scan

You can model IP services by doing a port scan, using the Nmap Security Scanner (<http://nmap.org/>). You must provide the full path to your system's `nmap` command.

To determine where `nmap` is installed, at the command line, enter:

```
which nmap
```

If your system returns a result similar to:

```
/usr/bin/which: no nmap in  
(/opt/zenoss/bin:/usr/kerberos/bin:/usr/local/bin:/bin:/usr/bin:/opt/zenoss/bin)
```

then nmap is not installed. Install it, and then try again.

After locating the `nmap` command (including the directory beginning with `/`), enter the following as the `zenoss` user on the Zenoss Core server:

```
cd $ZENHOME/libexec
ln -s Full_Path_to_nmap
```

To model a device using a port scan:

1. Select the device in the device list.
2. In the left panel, select **Modeler Plugins**.
3. Select the `zenoss.nmap.ipServiceMap` plugin in the list of Available plugins, and then use the right arrow control to move it to the list of Selected plugins.
4. Click **Save**.
5. Remodel the device.

### 3.3.3.1. Using the `/Server/Scan Device Class` to Monitor with Port Scan

The `/Server/Scan` device class is an example configuration for modeling devices by using a port scan. You can use this device class as a reference for your own configuration; or, if you have a device that will use only a port scan, you can place it under this device class and remodel the device.

## 3.4. About Modeler Plugins

Zenoss Core uses plug-in maps to map real world information into the standard model. Input to the plug-ins can come from SNMP, SSH or Telnet. Selection of plug-ins to run against a device is done by matching the plug-in name against the `zCollectorPlugins` configuration property. Plug-ins selected in `zCollectorPlugins` are the ones that are collected.

- **DeviceMap** – Collects basic information about a device, such as its OS type and hardware model.
- **InterfaceMap** – Collects the list of network interfaces on a device.
- **RouteMap** – Collects the network routing table from the device.
- **IpServicesMap** – Collects the IP services running on the device.
- **FileSystemMap** – Collects the list of file systems on a device.

### 3.4.1. Viewing and Editing Modeler Plugins for a Device

Plugins are controlled by regular expressions that match their names. To view a list of plugins for any device:

1. Click the device name in the devices list.

The Device summary page appears.

2. In the left panel, select **Modeler Plugins**.

The Modeler Plugins page appears.

#### 3.4.1.1. Adding Plugins

To add a plugin to a device:

1. Use the right arrow control to move one or more plugins from the Available list (on the left) to the Selected list (on the right).
2. Click **Save**.

### 3.4.1.2. Reordering Plugins

Plugins run in the order in which they are listed. To re-order plugins, use the up and down arrow controls, and then click **Save**.

### 3.4.1.3. Deleting Plugins from a Device

To delete a plugin from a device, use the left arrow control to move the plugin from the Selected list to the Available list.

## 3.5. Debugging the Modeling Process

You can run the modeler from the command line against a single device. This feature is useful when debugging issues with a plugin.

By passing the **--collect** command to the modeler, you can control which modeler plugins are used. For example, the following command runs only the interface plugin against the build.zenoss.loc device:

```
$ zenmodeler run -v10 --collect=IpInterface -d build.zenoss.loc
```

If the command returns any stack traces, check the community forums for assistance. Otherwise, forward these details to Support for assistance:

- Command you ran
- Stack trace or stack traces returned
- Version of your Zenoss Core instance
- OS version and patch level for the remote device

# Chapter 4. Working with Devices

This chapter provides information and procedures for managing devices in the system.

## 4.1. Viewing the Device List

The device list shows all devices in the system. From this view, you can search for devices and perform a range of management tasks on all devices.

To access the device list, select Infrastructure from the Navigation menu.

Figure 4.1. Device List

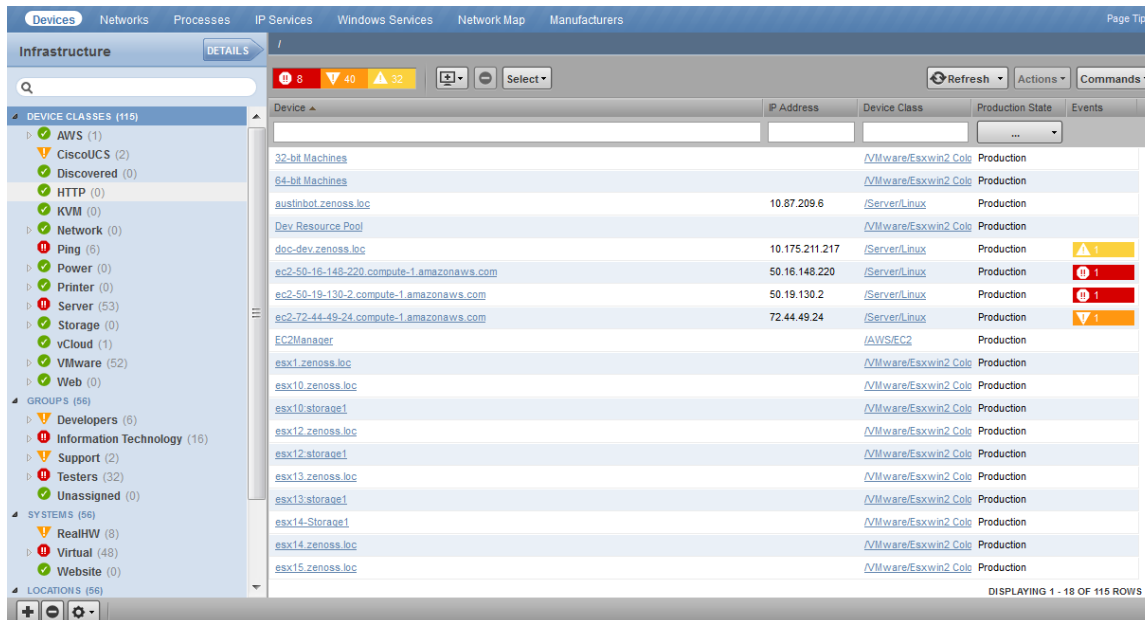

### 4.1.1. Devices Hierarchy

Devices are organized in the tree view by:

- Device class
- Group
- System
- Location

Click the indicator next to each category name to expand it and see included devices.

### 4.1.2. Managing Multiple Devices from the Device List

You can perform some management tasks for more than one device at a time. You can:

- Move devices to a different class
- Assign devices to groups, systems, and locations

- Remove devices
- Perform actions such as assign priority and production state
- Assign monitors for collecting from selected devices
- Lock devices

## 4.2. Working with Devices

To view details for a single device, click its name in the device list. The device overview page appears.

**Figure 4.2. Device Overview**

The screenshot displays the 'Device Overview' page for the device `t-cent5a-64.zenoss.loc`. The interface includes a navigation sidebar on the left and a main content area with several panels. At the top, the device name and IP address (`10.175.211.125`) are shown, along with a status indicator 'Up' and 'Production' state. The 'Overview' panel provides key metrics: Uptime (00d:17h:03m:08s), First Seen (2011/05/17 20:50:58), Last Change (2011/05/18 09:02:51), Model Time (2011/05/18 09:02:52), Locking (Unlocked), and Memory/Swap (3.9GB/2.0GB). The 'Device Name' panel shows the name `t-cent5a-64.zenoss.loc`, 'Production State' (Production), and 'Priority' (Normal). The 'Rack Slot' is set to 0. The 'Collector' is localhost. The 'Hardware Manufacturer' is Generic, and the 'Hardware Model' is Net-SNMP Agent. The 'OS Manufacturer' is Unknown, and the 'OS Model' is Linux 2.6.18-164.el5. The 'Systems' panel shows 'None' for Systems, Groups, and Location. The 'Links' and 'Comments' sections are also present. The 'SNMP' panel shows 'SNMP SysName' as t-cent5a-64.zenoss.loc, 'SNMP Location' as Unknown, 'SNMP Contact' as Root, 'SNMP Description' as Linux t-cent5a-64.zenoss.loc 2.6, and 'SNMP Community' as public. The bottom of the page features a 'Commands' dropdown menu.

Event status is shown in the "event rainbow" at the top of the page. Other key information that appears at the top of the device overview page includes:

- Device name
- IP address used to communicate with the device
- Device status (shows the current results of a ping test)
- Production state (Pre-Production, Production, Test, Maintenance, or Decommissioned)

When you open the page, device overview information displays. This view provides classification and status information. From here, you can edit device information (indicated by text fields or edit links). Editable fields include:

- Device name
- Production state
- Priority
- Collector
- Systems
- Groups
- Location
- Tag
- Serial Number
- Rack Slot
- Hardware and software manufacturer and model

The Links area displays links between the device and other external systems. For more information about custom links, see the chapter titled "Properties and Templates."

The left panel of the device overview page allows you to access other device management views, such as:

- Events
- Components
- Graphs
- Modeler Plugins
- Configuration Properties
- Software
- Administration
- Custom Properties
- Monitoring Templates

Information that appears here varies depending on device type.

### **4.2.1. Events**

Detailed information about events, scoped to the device, appears in the Events view. From here, you can:

- Sort event and event archive information by a range of categories
- Classify and acknowledge events
- Filter events by severity, state, or by one of several categories

## 4.2.2. Components

The Components view provides information about the different types of device components, including:

- IPService
- WinService
- IpRouteEntry
- IpInterface
- CPU
- FileSystem

To access components information, select Components in the left panel, and then select a component type.

**Figure 4.3. Device (Components)**

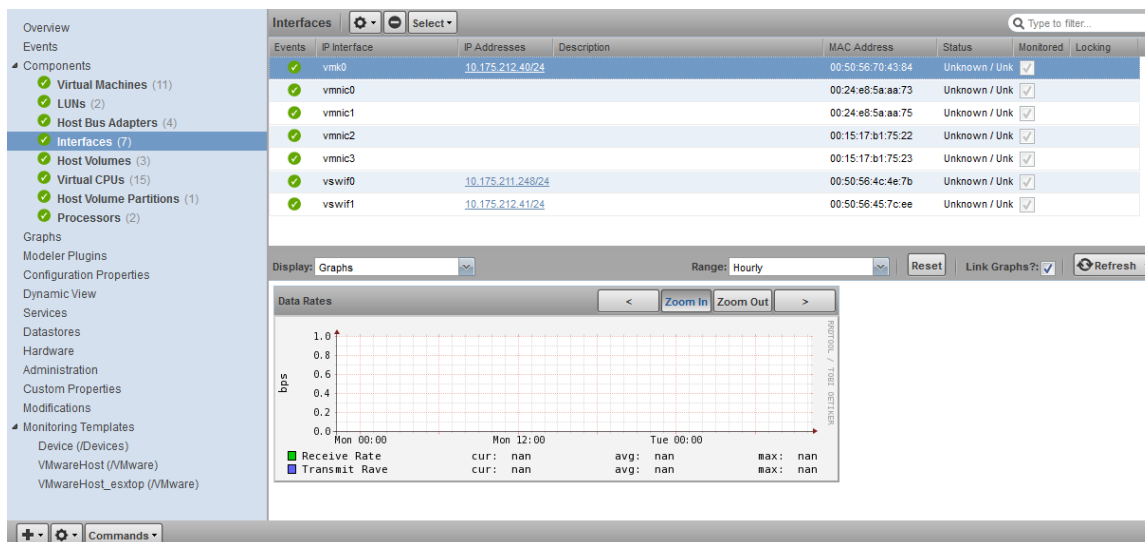

The status of each device component type, as shown by the color of its indicator, is determined by the collective status of the monitored components of the same type. For example, if the IpService status is green, then all monitored IpServices on the device are functioning normally. If there is an event related to a monitored IpService, then the highest severity event associated with that component is displayed.

### Note

If there is an event unrelated to a known component, then the system places it in the component type Other.

From this view, you can:

- Lock components
- Turn on or off component monitoring
- Delete components

## 4.2.3. Graphs

The Graphs view shows performance graphs defined for the device. To access graphs, select Graphs in the left panel.

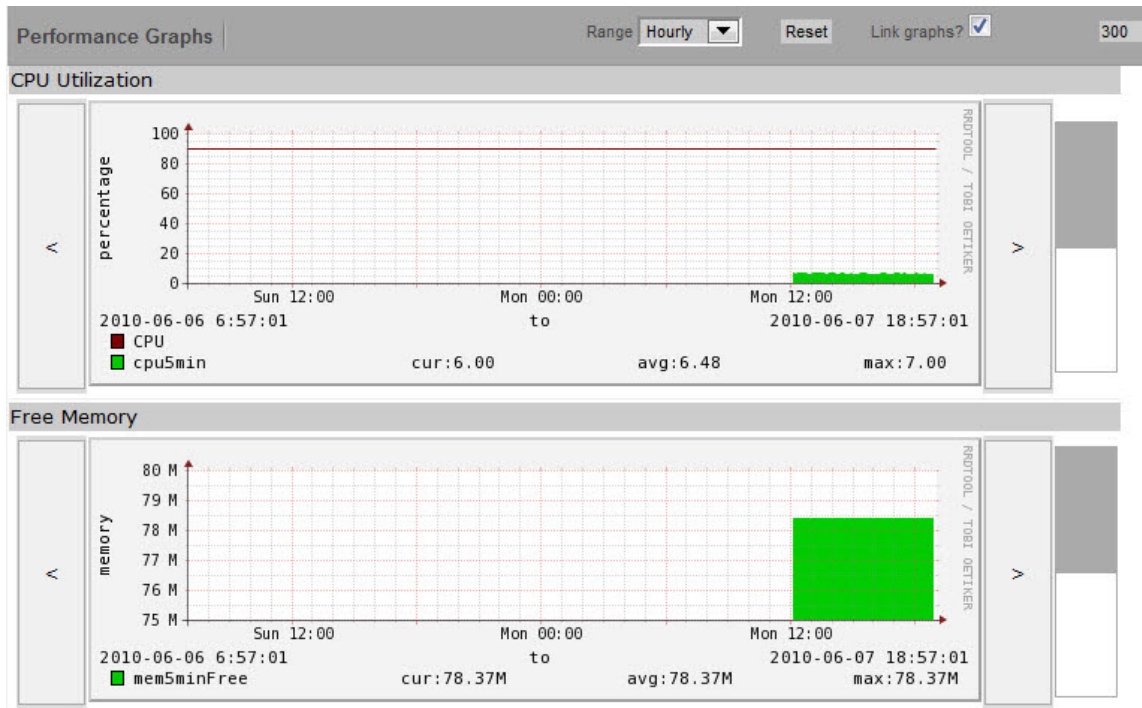
**Figure 4.4. Device (Graphs)**

## Tip

You can use the arrow key and magnifying glass controls on the sides of each graph to change the graph view, scrolling through or zooming in or out of a graph.

You can control these performance graph options:

- **Range** - Select the span of time displayed in the graph. You can select:
  - Hourly - Past 36 hours
  - Daily - Past ten days
  - Weekly - Past six weeks
  - Monthly - Past 15 months
  - Yearly - Past two years
- **Reset** - Click to return to the default (initial view) of the graphs.
- **Link graphs** - By default, all graphs move together. If you click the back arrow for a graph, for example, then all graphs move backward. De-select the Link graphs option to control each graph individually.
- **Stop/Start** - Toggle to turn off and on automatic refresh of the graphs. Optionally, modify the refresh value (by default, 300 seconds), and then click **Stop/Start** to begin refreshing graphs at the new interval.

For more information about performance monitoring and performance graphs, see the section titled "Performance Monitoring."



## 4.2.4. Modeler Plugins

Use the Modeler Plugins view to manage plugins that are run against a device. To access plugins, select Modeler Plugins in the left panel.

**Figure 4.5. Device (Modeler Plugins)**

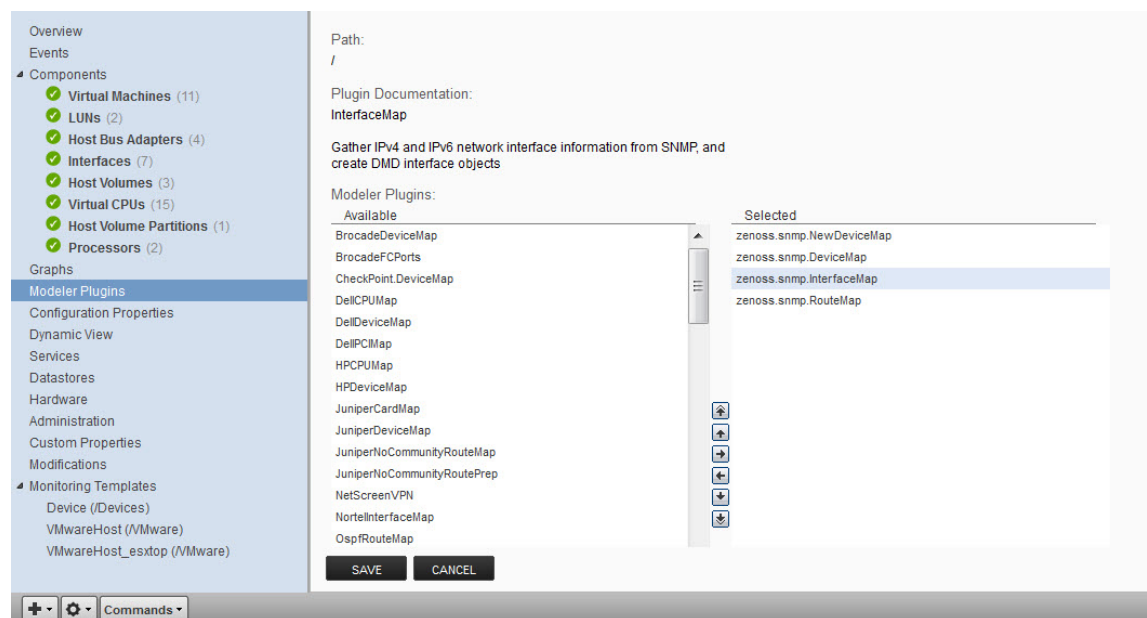

## 4.2.5. Configuration Properties

From the Configuration Properties view, you can configure certain configuration properties for a device. Further, you can delete local properties from a device.

To access configuration properties, select Configuration Properties in the left panel.

**Figure 4.6. Device (Configuration Properties)**

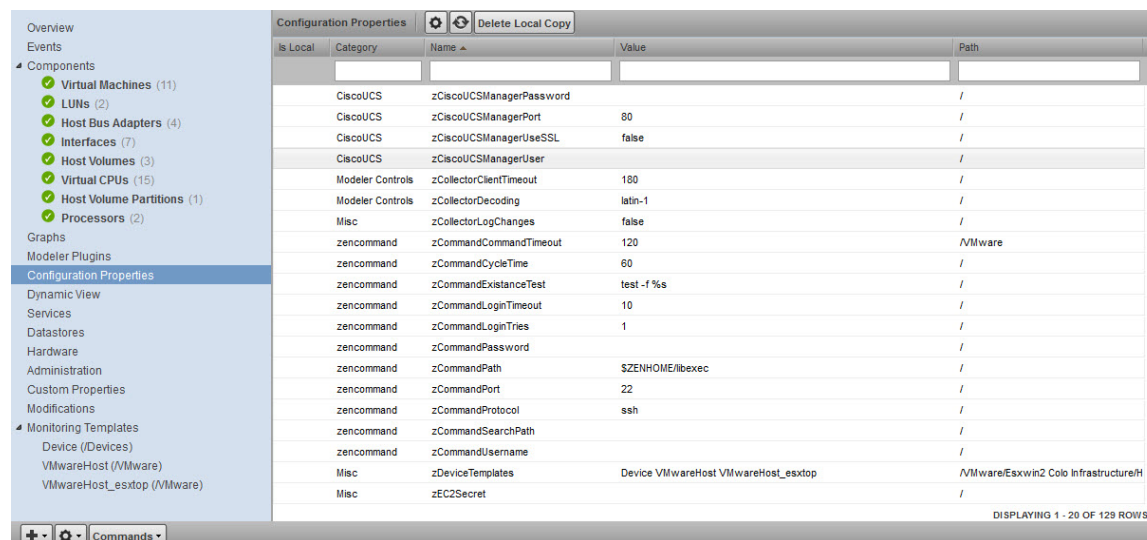

For detailed information about working with configuration properties, see the chapter titled "Properties and Templates."

## 4.2.6. Software

The Software view lists software installed on the device. The details provided in this area depend on the method used to model the device.

Listed software links into the system's inventory of software in your IT infrastructure. You can view this inventory from the Manufacturers link on the sub-navigation menu.

To access software information, select Software in the tree view.

## 4.2.7. Administration

Use the Administration view to:

- Add, delete, and run custom user commands
- Manage maintenance windows
- Determine who holds administration capabilities for the device, and their roles

To access administration options, select Administration in the left panel.

**Figure 4.7. Device (Administration)**

The screenshot displays the Administration view for a device, organized into three main sections:

- Define Commands:** A table with columns for Name, Description, Command, and Modifications. It lists five commands:
 

Name	Description	Command	Modifications
<a href="#">DNS forward</a>	Name to IP address lookup	host \${device/id}	<a href="#">Δ</a>
<a href="#">DNS reverse</a>	IP address to name lookup	host \${device/managelp}	<a href="#">Δ</a>
<a href="#">ping</a>	Is the device responding to ping?	ping -c2 \${device/managelp}	<a href="#">Δ</a>
<a href="#">snmpwalk</a>	Display the OIDs available on a device	snmpwalk -s\${device/zSnmpVer} -c\${device/zSnmpCommunity} \${here/managelp} system	<a href="#">Δ</a>
<a href="#">traceroute</a>	Show the route to the device	traceroute -q 1 -w 2 \${device/managelp}	<a href="#">Δ</a>
- Maintenance Windows:** A table with columns for Name, Start, Duration, Repeat, Start State, Stop State, Enabled?, and Modifications. The table is currently empty.
- Administrators:** A table with columns for Name, Role, Level, Email, and Pager. A **Save** button is located below the table.

See these topics for more information about device administration tasks:

- "Defining User Commands" in the chapter titled User Commands
- "Adding Administrators" in the chapter titled Managing Users

## 4.2.8. Custom Properties

Use the Custom Properties view to edit the values of custom properties applied to a device.

To access custom device properties, select Custom in the left panel.

**Figure 4.8. Device (Custom Properties)**

Custom Properties		
Property	Value	Type
cDateTest	1900/01/01	date

Save

You cannot define custom properties on an individual device. See the section titled "Adding Custom Properties" for more information.

## 4.2.9. Monitoring Templates

Monitoring templates determine how the system collects performance data for devices and device components.

To access monitoring templates, expand Monitoring Templates in the left panel, and then select Device. The page shows all of the monitoring templates that are bound by name to this device.

**Figure 4.9. Device (Monitoring Templates)**

Data Sources				Thresholds	
<div style="display: flex; justify-content: space-between;"> <span>+</span> <span>⊖</span> <span>⚙️</span> </div>				<div style="display: flex; justify-content: space-between;"> <span>+</span> <span>⊖</span> <span>⚙️</span> </div>	
Data Points by Data Source ▲	Source	Enabled	Type	Name	
▾ IaLoadInt1	1.3.6.1.4.1.2021.10.1.5.1	true	SNMP	high load	
▾ IaLoadInt15	1.3.6.1.4.1.2021.10.1.5.3	true	SNMP	low CPU idle	
▾ IaLoadInt5	1.3.6.1.4.1.2021.10.1.5.2	true	SNMP		
▾ memAvailReal	1.3.6.1.4.1.2021.4.6.0	true	SNMP		
▾ memAvailSwap	1.3.6.1.4.1.2021.4.4.0	true	SNMP		
▾ memBuffer	1.3.6.1.4.1.2021.4.14.0	true	SNMP		
▾ memCached	1.3.6.1.4.1.2021.4.15.0	true	SNMP		
▾ ssCpuIdle	1.3.6.1.4.1.2021.11.11.0	true	SNMP		
▾ ssCpuRawWait	1.3.6.1.4.1.2021.11.54.0	true	SNMP		
▾ ssCpuSystem	1.3.6.1.4.1.2021.11.10.0	true	SNMP		
▾ ssCpuUser	1.3.6.1.4.1.2021.11.9.0	true	SNMP		
▾ ssIORawReceived	1.3.6.1.4.1.2021.11.58.0	true	SNMP		
▾ ssIORawSent	1.3.6.1.4.1.2021.11.57.0	true	SNMP		
▾ sysUpTime	1.3.6.1.2.1.25.1.1.0	true	SNMP		

Graph Definitions	
<div style="display: flex; justify-content: space-between;"> <span>+</span> <span>⊖</span> <span>⚙️</span> </div>	
Name	
Load Average	
CPU Utilization	
Memory Utilization	
IO	

For detailed information about monitoring templates, go to the section titled "Performance Monitoring."

## 4.3. Managing Devices and Device Attributes

Read the information and procedures in this section to learn about specific device management tasks, including:

- Clearing heartbeat events
- Pushing configuration changes to the system
- Locking device configuration
- Renaming devices
- Remodeling devices

- Setting the device manage IP address

### 4.3.1. Clearing Heartbeat Events

If you have configured a device to send a recurring event that you have mapped to a heartbeat class, you can clear stale heartbeat events.

To clear the heartbeat events associated with a device:

1. Navigate to the device in the device list.
2. At the bottom of the device overview page, select Clear Heartbeats from  (Action Menu).

The Clear Heartbeats dialog appears.

3. Click **Submit** to confirm the clear action.

The system moves the heartbeat events for the device to event history and displays a confirmation message of the action.

### 4.3.2. Pushing Configuration Changes to Zenoss Core

When you make a configuration change, it is automatically propagated to all the remote collectors. If you think that your change has not been propagated correctly, then you can manually force a configuration "push" to the collectors.

To push configuration changes:

1. Navigate to the device in the device list.
2. At the bottom of the device overview page, select Push Changes from  (Action Menu).

The Push Changes dialog appears.

3. Click **Yes**.

The system pushes changes to the collectors and displays a confirmation message of the action.

### 4.3.3. Locking Device Configuration

You can lock a device's configuration to prevent changes from being overwritten when remodeling the device. Two levels of locking are available. You can lock the configuration from deletion and updates, or solely from deletion.

#### Note

Device locking prevents changes and deletion due to remodeling. It does not prevent manual changes and deletion.

To edit lock selections for a device configuration:

1. Navigate to the device in the device list.
2. At the bottom of the device overview page, select Lock from  (Action Menu).

The Lock dialog appears.

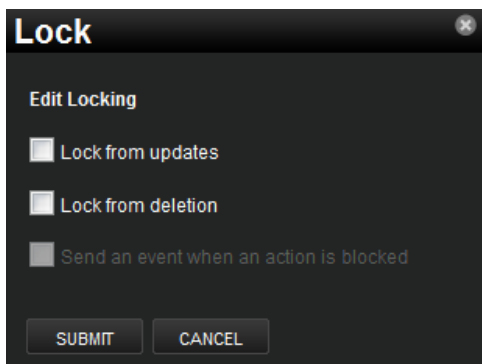
**Figure 4.10. Edit (Configuration) Lock Dialog**

3. To send events when actions are blocked by a lock action, select the "Send an event..." option.
4. Select the type of lock you want to implement or remove.

The lock or unlock action is implemented on the device, and the system displays a confirmation message of the action.

#### 4.3.4. Renaming a Device

Because the system uses the manage IP to monitor a device, the device name may be different than its fully qualified domain name (FQDN). The device name must always be unique.

To rename a device:

1. Navigate to the device in the device list.
2. At the bottom of the device overview page, select Rename Device from  (Action Menu).

The Rename Device dialog appears.

3. Enter the new name for the device, and then click **Submit**.

The system renames the device and displays a confirmation message of the action.

#### 4.3.5. Remodeling a Device

Remodeling forces the system to re-collect all configuration information associated with a device. Normally, the system models devices every 720 minutes; however, if you want to remodel a device immediately, follow these steps:

1. Navigate to the device in the device list.
2. At the bottom of the device overview page, select Model Device from  (Action Menu).

The system remodels the device. A dialog appears that shows progress of the action.

#### 4.3.6. Resetting the Device Manage IP Address

You might want to reset the manage IP address if the IP address of a device has changed and you want to maintain the historical data at the original IP address. To reset the manage IP address of a device:

1. Navigate to the device in the device list.
2. At the bottom of the device overview page, select Reset/Change IP Address from  (Action Menu).

The Reset IP dialog appears.

**Figure 4.11. Reset IP Dialog**

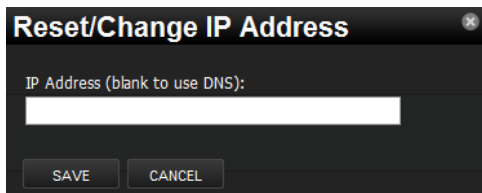

3. Enter the new IP address for the device, or leave the field blank to allow the IP address to be set by DNS.
4. Click **Save**.

The IP address for the device is reset.

### 4.3.7. Deleting a Device

To delete a device from the system:

1. Navigate to the device in the device list.
2. At the bottom of the device overview page, select Delete Device from  (Action Menu).

The Delete Device dialog appears.

**Figure 4.12. Delete Device**

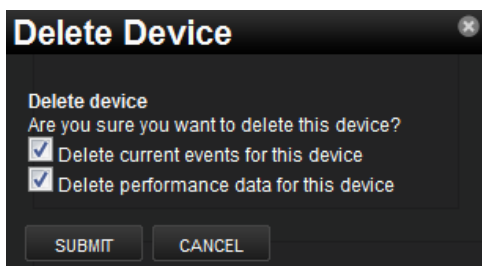

3. Optionally change the selections to delete current events or performance data for the device. By default, events and performance data are removed.
4. Click **Submit**.

The system removes the devices and associated data (if selected), and displays a confirmation message of the action.

### 4.3.8. Dumping and Loading Devices

Zenoss Core allows you to export a list of your devices to a text file to import into another Zenoss Core instance. You can do this by using the `zenbatchdump` command.

You cannot use `zenbatchdump` on devices whose classes were defined in a ZenPack.

From the command line, use the command:

```
zenbatchdump > mydevicelist.txt
```

This command writes the names of your devices (including their device classes, groups, and systems) to a file named `mydevicelist.txt`.

To load these devices into another instance (or reload them into the same instance), while in the Zenoss Core instance where you want the devices to be discovered, run the command:

```
zenbatchload mydevicelist.txt
```

The system attempts to discover each of the devices in the text file.

For additional ways to add and discover devices, see the "Add Devices" section of the *Core Installation*.

---

# Chapter 5. Properties and Templates

Read this chapter to learn more about:

- Configuration properties
- Monitoring templates

## 5.1. Configuration Properties

Configuration properties are individual values you can set up on major system entities, such as:

- **Devices**

*Device configuration properties* control the way devices are monitored.

- **Events**

*Event configuration properties* control the rules that process events as they are received by the system.

- **Networks**

*Network configuration properties* control options when you perform network discovery.

Configuration properties and values can be added to the ZenPacks you create, allowing you to customize the system when you add ZenPacks.

### 5.1.1. Configuration Properties Inheritance and Override

The following diagram illustrates a portion of the standard device class hierarchy. (A *device class* is a special type of organizer used to manage how the system models and monitors devices.)

**Figure 5.1. Device Class Hierarchy**

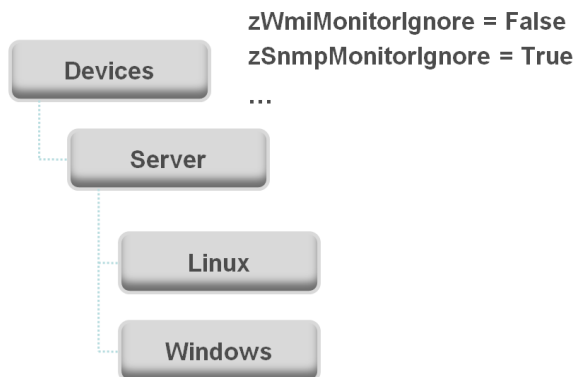

At the root of the device hierarchy is the Devices object. All device class configuration properties are defined here. Their values are the default values for the entire hierarchy.

The illustration shows two defined configuration properties:

- **zWmiMonitorIgnore** - Turns off all daemons that use WMI. By default, its value at the root of the hierarchy is False.



- **zSNMPMonitorIgnore** - Turns off all daemons that use SNMP. By default, its value at the root of the hierarchy is True.

Through *inheritance*, properties defined at the root of the hierarchy apply to all objects beneath that node. So, at the /Devices/Server/Linux level of the device class hierarchy, the value of these two properties is the same as at /Devices, even though the property is not set explicitly at /Devices/Server/Linux. Inheritance simplifies system configuration, because default values set at the root level apply to all devices irrespective of their device class.

To further customize the system, you can change a specific configuration property further down the hierarchy without having to change the definitions of other configuration properties. As shown in the following illustration, the value of zWmiMonitorIgnore is changed so that WMI monitoring is performed at the /Devices/Server/Windows level.

**Figure 5.2. Device Class Hierarchy - Locally Defined Value (Override)**

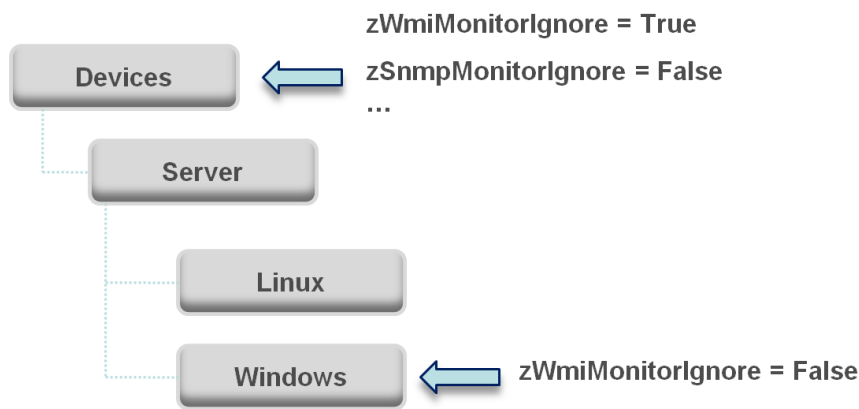

This locally defined value for zWmiMonitorIgnore *overrides* the value set at the root of the hierarchy. No other properties at this level are affected by this local change; they continue to inherit the value set at the root.

Configuration properties allow you to configure the system at a very granular level, down to a particular device. For example, in the following illustration, the device named dev.zenoss.com has the value of SNMP community set to private. This overrides the root value (public).

**Figure 5.3. Device Class Hierarchy - Value Set on Device**

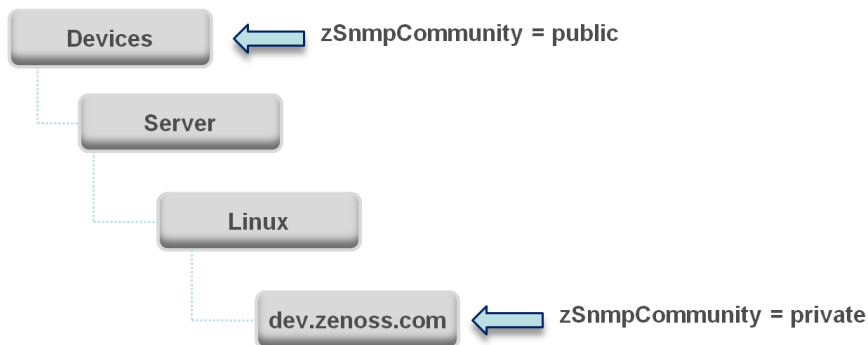

If you change the SNMP Community value of dev.zenoss.com to public, it matches the value set at the root, but is still explicitly defined. Only if you remove the locally defined property does it again inherit the value of the property set at the root.

### 5.1.1.1. Viewing Properties from the User Interface

This section further illustrates the characteristics of configuration properties from the user interface perspective. The following screen shows device configuration properties defined at the root level. To view configuration properties:

1. Select Infrastructure from the Navigation menu.

The Devices page appears.

2. Click **Details**.

3. Select Configuration Properties.

**Figure 5.4. Defined Device Configuration Properties - Root Level**

Configuration Properties				
Is Local	Category	Name	Value	Path
Yes	CiscoUCS	zCiscoUCSManagerPassword		/
Yes	CiscoUCS	zCiscoUCSManagerPort	80	/
Yes	CiscoUCS	zCiscoUCSManagerUseSSL	false	/
Yes	CiscoUCS	zCiscoUCSManagerUser		/
Yes	Modeler Controls	zCollectorClientTimeout	180	/
Yes	Modeler Controls	zCollectorDecoding	latin-1	/
Yes	Misc	zCollectorLogChanges	false	/
Yes	zencommand	zCommandCommandTimeout	15	/
Yes	zencommand	zCommandCycleTime	60	/
Yes	zencommand	zCommandExistenceTest	test -f %s	/
Yes	zencommand	zCommandLoginTimeout	10	/
Yes	zencommand	zCommandLoginTries	1	/
Yes	zencommand	zCommandPassword		/
Yes	zencommand	zCommandPath	\$ZENHOME/libexec	/
Yes	zencommand	zCommandPort	22	/
Yes	zencommand	zCommandProtocol	ssh	/
Yes	zencommand	zCommandSearchPath		/
Yes	zencommand	zCommandUsername		/
Yes	Misc	zDeviceTemplates	Device	/
Yes	Misc	zEC2Secret		/
Yes	Modeler Controls	zFileSystemMapIgnoreNames		/
Yes	Modeler Controls	zFileSystemMapIgnoreTypes	other ram virtualMemory removableDisk floppyDisk compactDisk ramDisk f	/
Yes	Misc	zFileSystemServiceOffset	1	/

DISPLAYING 1 - 22 OF 127 ROWS

As shown in the previous screen, the zCollectorClientTimeout configuration property has a default value of 180. In the next screen, the value has been set to 170 at the /Server/Linux device class, overriding the default value at this node of the hierarchy.

**Figure 5.5. zCollectorClientTimeout Configuration Property - Local Value Set**

Configuration Properties <span>⚙️</span> <span>↺</span> <span>Delete Local Copy</span>				
Is Local	Category	Name ▲	Value	Path
	CiscoUCS	zCiscoUCSManagerPassword		/
	CiscoUCS	zCiscoUCSManagerPort	80	/
	CiscoUCS	zCiscoUCSManagerUseSSL	false	/
	CiscoUCS	zCiscoUCSManagerUser		/
Yes	Modeler Controls	zCollectorClientTimeout		/Server/Linux/devices/t-cent5a-64.zeno
	Modeler Controls	zCollectorDecoding		/
	Misc	zCollectorLogChanges		/
	zencommand	zCommandCommandTimeout	15	/
	zencommand	zCommandCycleTime	60	/
	zencommand	zCommandExistenceTest	test -f %s	/
	zencommand	zCommandLoginTimeout	10	/
	zencommand	zCommandLoginTries	1	/

DISPLAYING 1 - 13 OF 127 ROWS

Shows the node at which the default value is overridden

To remove the override and once again inherit the value from the root of the hierarchy:

1. Select the property in the list.
2. Click **Delete Local Copy**.

The Delete Local Property dialog appears, and requests confirmation of the action.

3. Click **OK**.

### 5.1.2. Configuration Property Types

Configuration properties can be one of these types:

- **String** - Text value that can be ASCII or Latin-1 encoded
- **Integer** - Whole number
- **Float** - Number that can have a decimal value
- **Boolean** - True or False
- **Lines** - List of values separated by a return. The system stores these as an array.

### 5.1.3. Device Configuration Properties

To view and edit device configuration properties at the root level:

1. Select Infrastructure from the Navigation menu.
2. In the tree view, click **Details**.
3. Select Configuration Properties.

To view and edit device configuration properties set at a specific device class, navigate to that class, click **Details**, and then select Configuration Properties.

You also can view and edit device configuration at the individual device level. Select the device from the device list, and then select Configuration Properties from the left panel.

The following table lists device configuration properties.

**Table 5.1. Device Configuration Properties**

Property Name	Property Type	Description
zCollectorClientTimeout	int	Allows you to set the timeout time of the collector client in seconds
zCollectorDecoding	string	Converts incoming characters to Unicode.
zCollectorLogChanges	Boolean	Indicates whether to log changes.
zCollectorPlugins	lines	Links to all modeler plugins for this device.
zCommandCommandTimeout	float	Specifies the time to wait for a command to complete.
zCommandCycleTime	int	Specifies the cycle time you use when executing zCommands for this device or organizer. This property is not used directly by Zenoss Core; it is used in TALES expressions that can be set on command data sources.
zCommandExistanceTest	string	***
zCommandLoginTimeout	float	Specifies the time to wait for a login prompt.
zCommandLoginTries	int	Sets the number of times to attempt login.
zCommandPassword	string	Specifies the password to use when performing command logins and SSH.
zCommandPath	string	Sets the default path where ZenCommand plug-ins are installed on the local Zenoss Core box (or on a remote box where SSH is used to run the command).
zCommandPort	int	Specifies the port to connect to when performing command collection.
zCommandProtocol	string	Establishes the protocol to use when performing command collection. Possible values are SSH and telnet.
zCommandSearchPath	lines	Sets the path to search for any commands.
zCommandUsername	string	Specifies the user name to use when performing command collection and SSH.
zDeviceTemplates	lines	Sets the templates associated with this device. Linked by name.
zFileSystemMapIgnoreNames	string	Sets a regular expression of file system names to ignore.
zFileSystemMapIgnoreTypes	lines	Do not use.
zFileSystemSizeOffset	int	SNMP typically reports the total space available to privileged users. Zenoss Core (like the <code>df</code> command) reports capacity based on the space available to non-privileged users. The value of <code>zFileSystemSizeOffset</code> should be the fraction of the total space that is available to non-privileged users. The default reserved value is 5% of total space, so <code>zFileSystemSizeOffset</code> is preset to .95. If the reserved portion is different than 5%, then adjust the value of <code>zFileSystemSizeOffset</code> accordingly. The fraction should be set

Property Name	Property Type	Description
		according to the value ( <i>Used + Avail</i> ) / <i>Size</i> when the <code>df -PkH</code> command is run at the command line.
zIcon	lines	Specifies the icon to represent the device wherever device icon is shown, such as on the network map and device status page.
zIdiomUsername	string	
zIdiomPassword	string	
zIfDescription	Boolean	Shows the interface description field in the interface list.
zInterfaceMapIgnoreDescriptions	string	Filters out interfaces based on description.
zInterfaceMapIgnoreNames	string	Filters out interfaces that should not be discovered.
zInterfaceMapIgnoreTypes	string	Filters out interface maps that should not be discovered.
zIpServiceMapMaxPort	int	Specifies the highest port to scan. The default is 1024.
zKeyPath	lines	Sets the path to the SSH key for device access.
zLinks	text	Specifies a place to enter any links associated with the device.
zLocalInterfaceNames	string	Regular expression that uses interface name to determine whether the IP addresses on an interface should be incorporated into the network map. For instance, a loopback interface "lo" might be excluded.
zLocalIpAddresses	int	Specifies IP addresses that should be excluded from the network map (for example. 127.x addresses). If you have addresses that you reuse for connections between clustered machines they might be added here as well.
zMaxOIDPerRequest	int	Sets the maximum number of OIDs to be sent by the SNMP collection daemons when querying information. Some devices have small buffers for handling this information so the number should be lowered.
zPingMonitorIgnore	Boolean	Whether or not to ping the device.
zProdStateThreshold	int	Production state threshold at which Zenoss Core will begin to monitor a device.
zPythonClass	string	DO NOT USE
zRouteMapCollectOnlyIndirect	Boolean	Only collect routes that are directly connected to the device.
zRouteMapCollectOnlyLocal	Boolean	Only collect local routes. (These usually are manually configured rather than learned through a routing protocol.)
zSnmpAuthPassword	string	The shared private key used for authentication. Must be at least 8 characters long.
zSnmpAuthType	string	Use "MD5" or "SHA" signatures to authenticate SNMP requests
zSnmpCollectionInterval	int	Defines, in seconds, how often the system collects performance information for each device.
zSnmpCommunities	lines	Array of SNMP community strings that ZenModeler uses when collecting SNMP information. When you set this property, communities are tried in order; the first in the list that is successful is used as zSnmpCommunity. If none is successful, then the current value of zSnmpCommunity is used. The default value for the entire system is "public."

Property Name	Property Type	Description
zSnmpCommunity	string	Community string to be used when collecting SNMP information. If it is different than what is found by ZenModeler, it will be set on the modeled device.
zSnmpMonitorIgnore	Boolean	Whether or not to ignore monitoring SNMP on a device.
zSnmpPort	int	Port that the SNMP agent listens on.
zSnmpPrivPassword	string	The shared private key used for encrypting SNMP requests. Must be at least 8 characters long.
zSnmpPrivType	string	"DES" or "AES" cryptographic algorithms.
zSnmpSecurityName	string	The Security Name (user) to use when making SNMPv3 requests.
zSnmpTimeout	float	Timeout time in seconds for an SNMP request
zSnmpTries	int	Amount of tries to collect SNMP data
zSnmpVer	string	SNMP version used. Valid values are v1, v2c, v3
zStatusConnectTimeout	float	The amount of time that the zenstatus daemon should wait before marking an IP service down.
zTelnetEnable	Boolean	When logging into a Cisco device issue the enable command to enable access during command collection.
zTelnetEnableRegex	string	Regular expression to match the enable prompt.
zTelnetLoginRegex	string	Regular expression to match the login prompt.
zTelnetPasswordRegex	string	Regular expression to match the password prompt.
zTelnetPromptTimeout	float	Time to wait for the telnet prompt to return.
zTelnetSuccessRegexList	lines	List of regular expressions to match the command prompt.
zTelnetTermLength	Boolean	On a Cisco device, set term length to Zero.
zWinEventlog	Boolean	Whether or not to send the log.
zWinEventlogClause	string	Allows for specific queries (per device) on the Windows event log.
zWinEventlogMinSeverity	int	Sets minimum severity to collect from the win event log. The higher the number, the lower the severity. (1 is most severe; 5 is least severe.)
zWinPassword	string	The password used to remotely login if it is a Windows machine.
zWinUser	string	User name used to remotely login if it is a Windows machine.
zWmiMonitorIgnore	Boolean	Use to turn on or off all WMI monitoring.
zXmlRpcMonitorIgnore	Boolean	Use to turn on or off all XML/RPC monitoring.

### 5.1.4. Event Configuration Properties

To view and edit event configuration properties at the root level:

1. Select Events from the Navigation menu, and then select Event Classes.
2. In the left panel, select Configuration Properties.

To view and override event configuration properties for a specific event class, navigate to that class, and then select Configuration Properties.

The following table lists event configuration properties.

**Table 5.2. Event Configuration Properties**

Property Name	Property Type	Description
zEventAction	string	Specifies the database table in which an event will be stored. Possible values are: status, history and drop. Default is status, meaning the event will be an “active” event. History sends the event directly to the history table. Drop tells the system to discard the event.
zEventClearClasses	lines	Lists classes that a clear event should clear (in addition to its own class).
zEventSeverity	int	Overrides the severity value of events from this class. Possible values are 0 – 5.

### 5.1.5. Network Configuration Properties

To view and edit network configuration properties, select Infrastructure, and then select Networks. The Networks page appears, listing networks by IP address.

**Figure 5.6. Networks**

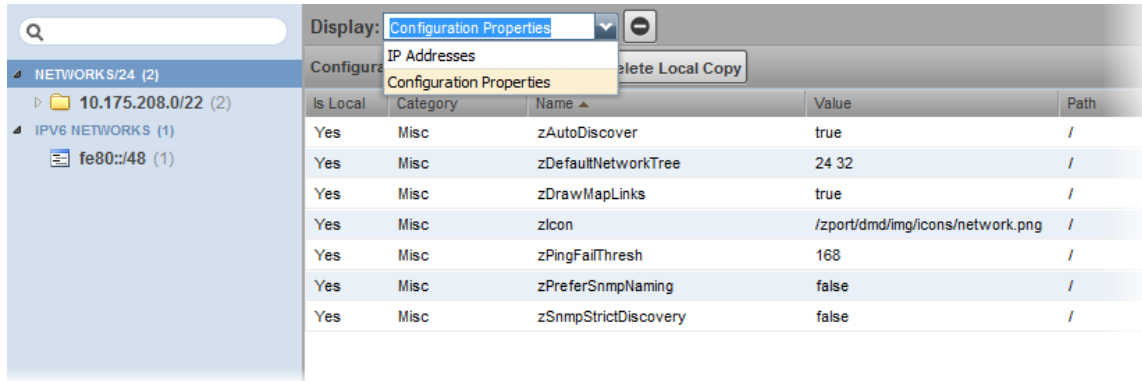

You can view and change network configuration property values and inheritance selections. From the Display list of options, select Configuration Properties.

The following table lists network configuration properties.

**Table 5.3. Network Configuration Properties**

Property Name	Property Type	Description
zAutoDiscover	Boolean	Specifies whether zendisc should perform auto-discovery on this network. (When performing network discovery, this property specifies whether the system should discover devices and subnetworks on the network.)
zDefaultNetworkTree	lines	A network subnet is automatically created for each modeled device, based on that device's subnet mask setting. To create higher-level subnets automatically from the discovery and modeling processes, add the specific subnet mask breakpoints. For example: 8, 16. If you then model a device with, for example, an IP address of 192.168.0.1, and a subnet mask of 255.255.255.0

Property Name	Property Type	Description
		(corresponding to a /24 subnet), device discovery will create a 192.0.0.0/8 network containing 192.168.0.0/16, containing 192.168.0.0/24, containing your device.
zDrawMapLinks	Boolean	Calculating network links "on the fly" is resource-intensive. If you have a large number of devices that have been assigned locations, then drawing those map links may take a long time. You can use this property to prevent the system from drawing links for specific networks (for example, a local network comprising many devices that you know does not span multiple locations).
zIcon	string	Use to specify device icons that appear on the device status page, Dashboard, and network map.
zPingFailThresh	int	Specifies the number of pings sent without being returned before zendisc removes the device.
zPreferSnmpNaming	Boolean	Specifies that when network discovery occurs, it uses the device name comes from SNMP rather than reverse DNS.
zSnmpStrictDiscovery	Boolean	Specifies that if SNMP does not exist on the device during network discovery, ignore the device.

## 5.2. Templates

The system stores performance configuration data in *templates*. Templates contain other objects that define where and how to obtain performance data, thresholds for that data, and data graphs.

You can define a template anywhere in the device class hierarchy, or on an individual device.

Templates are divided among three types:

- Device
- Component
- Interface

### 5.2.1. Copying Templates

You can create a template by copying an existing template. To copy a template, use the copy/override action.

1. Navigate to the template you want to copy.
2. From the Action menu, select Copy / Override Template.

The Copy / Override dialog appears.

3. Select the template to override, and then click **Submit**.

The listed template indicates that it is now locally defined.

### 5.2.2. Renaming Templates

To rename an existing template:



1. Select **Advanced**, and then select **Monitoring Templates**.
2. Expand the organizer containing the template to be renamed, and then class containing the template.
3. From the **Action** menu, select **View and Edit Details**.

The **Edit Template Details** dialog appears.

4. Enter a new name in the **Name** field.
5. Click **Submit**.

### 5.2.3. Template Binding

The determination of which templates apply to what objects is called *binding*. Templates are bound in different ways, depending on the objects to which they are bound.

#### 5.2.3.1. Device Templates

Device templates are applied to devices, one to each device. The system employs a single rule to bind device templates to devices: the value of the `zDeviceTemplates` property. For most device classes, this is "Device."

Common device templates are:

- Device
- MySQL
- Apache
- Active Directory
- MExchangeIS
- MSSQLServer
- IIS

For the `Server/Linux/MySQL` device class, the `zDeviceTemplates` property might contain, for example, "Device" and "MySQL." The system would collect CPU and memory information by using the `Device` template, and MySQL-specific metrics by using the `MySQL` template.

##### 5.2.3.1.1. Binding Templates

To bind a device template to a device class or device:

1. From the devices list, select a device class or device.
2. Select **Bind Templates** from  (Action Menu).

The **Bind Templates** dialog appears.

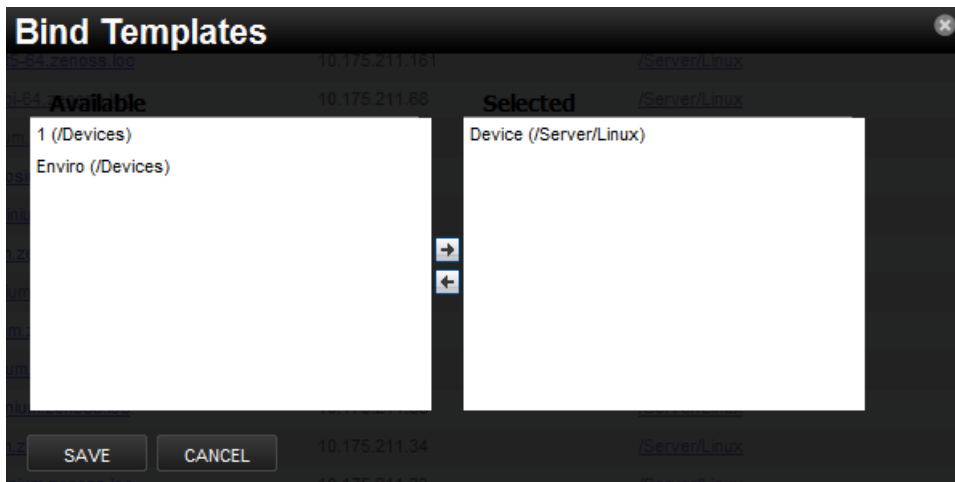
**Figure 5.7. Bind Templates**

3. Move templates between the Available and Selected lists using the arrows.
4. Click **Save**.

#### 5.2.3.1.2. Resetting Bindings

Resetting template bindings removes all locally bound templates and uses the default template values. To reset bindings for a selected device or device class:

1. Select Reset Bindings from  (Action Menu).

The Reset Template Bindings dialog appears.

2. Click **Reset Bindings** to confirm the action.

#### 5.2.3.2. Component Templates

Component templates are named exactly according to the name of the underlying class that represents a component. For example, the FileSystem template is applied to file systems. Component templates can be applied multiple times to each device, depending on how many of the device's components match the template. Configuration properties do not control the application of component templates.

### Note

Component templates should not be manually bound.

Common component templates are:

- FileSystem, HardDisk, IPService, OSProcess, WinService
- Fan, PowerSupply, TemperatureSensor
- LTMVirtualServer, VPNTunnel

### 5.2.3.3. Interface Templates

Interface templates are applied to network interfaces by using a special type of binding. Instead of using the name of the underlying class, the system looks for a template with the same name as the interface type. You can find this type in the details information for any network interface.

If Zenoss Core cannot locate a template that matches the interface type, then it uses the ethernetCsmacd template.

## 5.2.4. Examples

### 5.2.4.1. Example: Defining Templates in the Device Hierarchy

You add a new device at `/Devices/Server/Linux` named `Example1Server`. You have not edited the value of its `zDeviceTemplates` property, so it inherits the value of "Device" from the root device class (`/Devices`). Zenoss Core looks to see if there is a template named `Device` defined on `Example1Server` itself. There is not, so it checks `/Devices/Server/Linux`. There is a template named `Device` defined for that device class, so that template is used for `Example1Server`. (There also is a template named `Device` defined at the root level (`/Devices`), but the system does not use this one because the template at `/Devices/Server/Linux` overrides it.)

### 5.2.4.2. Example: Applying Templates to Multiple Areas in the Device Hierarchy

You want to perform specific monitoring of servers running a certain Web application, but those servers are spread across several different device classes. You create a template at `/Devices` called `WebApplication` with the appropriate data sources, thresholds and graphs. You then append the name "WebApplication" to the `zDeviceTemplates` configuration property for the devices classes, the individual devices running this Web application, or both.

---

# Chapter 6. Core Monitoring

Read the following sections for more information about basic and advanced monitoring, including:

- Availability monitoring
- Performance monitoring
- Monitoring using ZenCommand
- SNMP monitoring
- Monitoring devices remotely through SSH
- Monitoring windows devices

## 6.1. Availability Monitoring

The availability monitoring system provides active testing of the IT infrastructure, including:

- Devices
- Network
- Processes
- Services

Availability monitoring is facilitated by:

- **ZenPing** - The system's Layer-3 aware, topology-monitoring daemon. ZenPing performs high-performance, asynchronous testing of ICMP status. The most important element of this daemon is that Zenoss Core has built a complete model of the your routing system. If there are gaps in the routing model, the power of ZenPing's topology monitoring will not be available. If there are gaps, this issue can be seen in the `zenping.log` file.
- **ZenStatus** - Performs active TCP connection testing of remote daemons.

Zenmodeler discovers the routes to each device in the network. The system tries not to use Internet routing tables, relying instead on Zenmodeler to discover the relationships and create its own network map.

If any known route is broken, then only one ping event is generated by the outage. Any additional outages will only flag that device and the next time a ping sweep occurs the errors beyond the known router will not occur.

This monitoring model breaks down if the routers do not share their routing tables and interface information.

### 6.1.1. Controlling Ping Cycle Time

Follow these steps to modify the ping cycle time.

1. Select Advanced, and then select Collectors.
2. Click a collector in the list.

3. Select Edit in the left panel.
4. Edit the value of Ping Cycle Time.

On the next configuration cycle, the ping monitor will ping at the newly defined interval.

## 6.1.2. Using the Predefined /Ping Device Class

The /Ping device class is a configuration for devices that you want to monitor only for availability. The system does not gather performance data for devices placed in this class. You can use the /Ping device class as a reference for your own configuration; or, if you have a device that you want to monitor solely for availability, you can place it under this class.

## 6.1.3. Monitoring Processes

When enabled, the system can monitor the availability of all processes running on your network. As illustrated by the following diagram, ZenProcess checks for the existence of monitored processes. It uses a regular expression match to find PIDs matching the expression to see that these processes are running on a specific device.

**Figure 6.1. Process Monitoring**

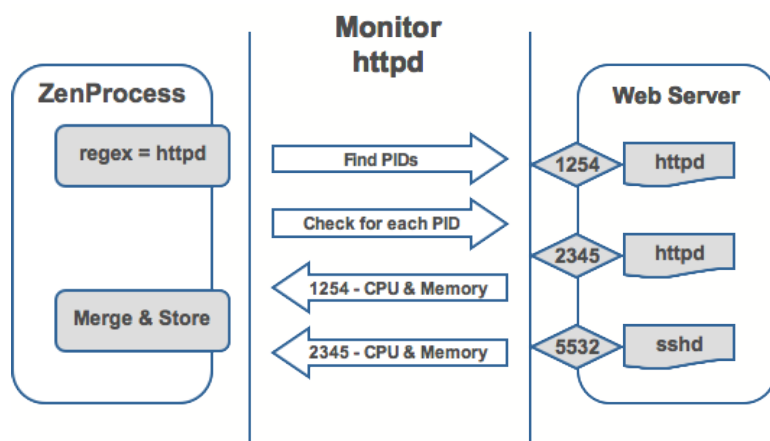

Use the Processes page (Infrastructure > Processes) to manage and monitor processes that are running on your network.

**Figure 6.2. Processes**

Name	Count
process0	0
process1	0
process10	0
process100	0
process101	0
process102	0
process103	0
process104	0
process105	0

Configuration options:

- Name:
- Description:
- Enable Monitoring? (zMonitor):  Set Local Value:   Inherit Value
- Send Event on Restart? (zAlertOnRestart):  Set Local Value:   Inherit Value
- Failure Event Severity (zFailSeverity):  Set Local Value:   Inherit Value

The tree view lists all running processes. Filter this list by using the active search area at the top of the view.

### 6.1.3.1. Monitoring a Process

To select a process to monitor, or edit monitoring choices for a process, follow these steps:

1. In the Processes page tree view, select the process to monitor.
2. Make one or more selections:
  - **Enable Monitoring (zMonitor)** - By default, Inherit Value is selected for all processes below the Processes node. When selected, the process will inherit monitoring choices from its parent. If you want to individually enable monitoring choices for the process, select the Set Local Value option, and then select a value.
  - **Send Event on Restart (zAlertOnRestart)** - By default, Inherit Value is selected for all processes below the Processes node. When selected, the process will inherit alert choices from its parent. If you want to individually select alert choices for the process, select the Set Local Value option, and then select a value.
  - **Failure Event Severity (zFailSeverity)** - By default, Inherit Value is selected for all processes below the Processes node. When selected, the process will inherit severity level choices from its parent. If you want to individually select severity levels for the process, select the Set Local Value option, and then select a value.
3. In the Regular Expression area, enter information or make selections:
  - **Pattern** - Enter text, as a regular expression, that the system will match to define this process.

#### Tip

For more information about regular expressions, go to:

[http://en.wikipedia.org/wiki/Regular\\_expression](http://en.wikipedia.org/wiki/Regular_expression)

- **Ignore Parameters** - Select this option to ignore command parameters when matching processes. By default, this option is disabled.
4. Click **Save** to save your choices.

The next time the device is remodeled (either at the next remodeling interval or when manually initiated), each device (occurrence) where this process is running will appear in the Devices area.

If a process has multiple instances, the system will monitor the sum of CPU and memory utilization of all processes as well as the count of total processes running. However, if the process has only a single instance, CPU utilization and memory usage will be graphed for the single process.

To perform process monitoring using the `zenprocess` daemon, the device's SNMP agent must show the process information through the HOST-RESOURCES MIB.

### 6.1.4. Monitoring IP Services

The IP Services page (Infrastructure > IP Services) lets you manage and monitor IP services that are running on your network.

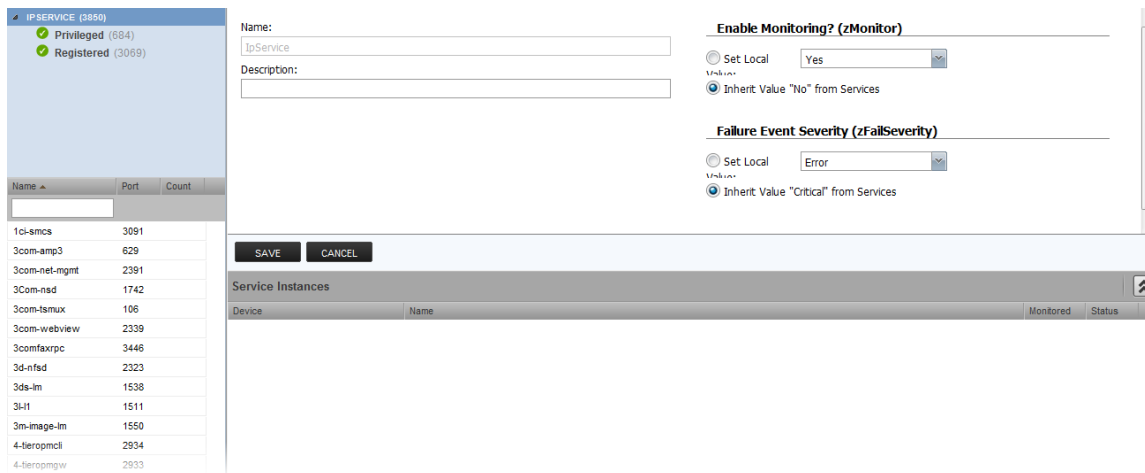
**Figure 6.3. IP Services**

The tree view lists all monitored IP services. Filter this list by using the active search area at the top of the view.

The details area shows:

- Service class description
- TCP port
- Associated service keys

To add or change details for a service class, enter or change information, and then click **Save**.

The lower section of the page lists currently running services in this class (by device), and shows their monitoring status.

### 6.1.4.1. Enabling IP Service Monitoring

You can choose to monitor:

- Individual services
- Service classes

When monitoring a service class, you can choose not to monitor one or more individual services in the class. For example, the SMTP service class is monitored by default, but may not be a critical service on some devices. In this case, you can disable its monitoring on those devices.

#### Note

If a service is configured to listen only on local host (127.0.0.1), then it is not monitored by default.

To enable monitoring for a service class or service:

1. In the tree view, select the service class or service to monitor.
2. Make one or more selections:

- **Enable Monitoring (zMonitor)** - By default, Inherit Value is selected for all services below the IPService node. When selected, the service class or service will inherit monitoring choices from its parent. If you want to individually enable monitoring choices, select the Set Local Value option, and then select a value.
- **Failure Event Severity (zFailSeverity)** - By default, Inherit Value is selected for all services below the IPService node. When selected, the service class or service will inherit severity level choices from its parent. If you want to individually select severity levels, select the Set Local Value option, and then select a value.

3. Click **Save** to save your choices.

### 6.1.4.2. Using the Predefined /Server/Scan Device Class

The predefined /Server/Scan device class is an example configuration for monitoring TCP services on devices using a port scan. If you have a device that you want to monitor for service availability alone, you can place it under this device class. The system will not collect performance data for devices in this class.

### 6.1.4.3. Choosing an IP Address to Check for IP Services

Most server processes listen on the "0.0.0.0" address (all network interfaces). In this case, Zenoss Core automatically selects a device's management IP address (the IP address listed on the Status tab).

Firewall access can prevent a service from being contacted on a device's management IP, but will allow the service to be contacted on a different IP address. In this case, Zenoss Core allows you to override the default behavior and select the IP address from a list of addresses available on the device.

To change the IP address where an IP service will be probed, follow these steps:

1. From the Zenoss Core interface, navigate to the device.
2. Select the OS tab.
3. From the IP Services table, select the IP service you want to change.
4. Select the desired IP address to probe the service in the Check IP Address field.
5. Click **Save**.

## 6.2. Performance Monitoring

Read this chapter to learn about performance monitoring and monitoring templates.

### 6.2.1. About Performance Monitoring

Zenoss Core uses several methods to monitor performance metrics of devices and device components. These are:

- **ZenPerfSNMP** - Collects data through SNMP from any device correctly configured for SNMP monitoring.
- **ZenWinPerf** - ZenPack that allows performance monitoring of Windows servers.
- **ZenCommand** - Logs in to devices (by using telnet or SSH) and runs scripts to collect performance data.
- **Other ZenPacks** - Collect additional performance data. Examples include the ZenJMX ZenPack, which collects data from enterprise Java applications, and the HttpMonitor ZenPack, which checks the availability and responsiveness of Web pages.



Regardless of the monitoring method used, the system stores performance monitoring configuration information in *monitoring templates*.

## 6.2.2. About Monitoring Templates

Monitoring templates determine how the system collects performance data for devices and device components. You can define monitoring templates for device classes and individual devices.

Templates comprise three types of objects:

- **Data Sources** - Specify the exact data points to collect, and the method to use to collect them.
- **Thresholds** - Define expected bounds for collected data, and specify events to be created if the data does not match those bounds.
- **Graph Definitions** - Describe how to graph the collected data on the device or device components.

Before the system can collect performance data for a device or component, it must determine which monitoring templates apply. This process is called *template binding*.

### 6.2.2.1. Viewing Monitoring Templates

To view monitoring templates, select Advanced from the Navigation menu, and then select Monitoring Templates.

**Figure 6.4. Monitoring Template for Load Average Graph**

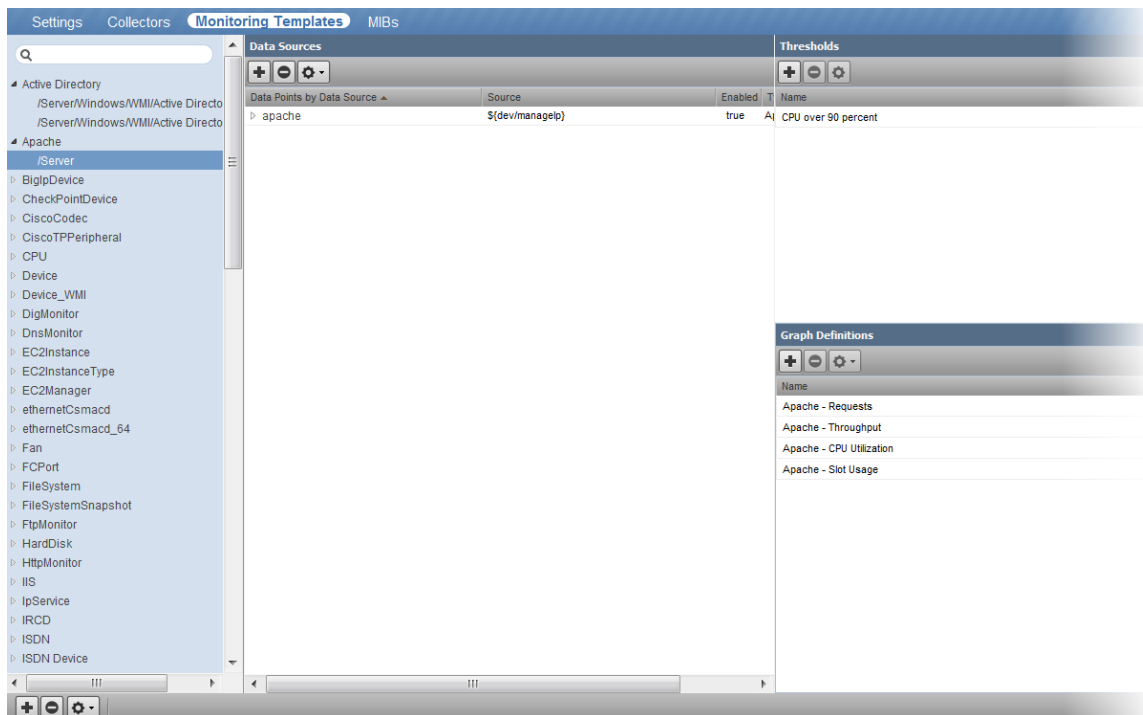

## 6.2.3. Template Binding

Before the system can collect performance data for a device or component, it must determine which templates apply. This process is called template binding.

First, the system determines the list of template names that apply to a device or component. For device components, this usually is the meta type of the component (for example, FileSystem, CPU, or HardDisk). For devices, this list is defined by the `zDeviceTemplates` configuration property.

After defining the list, the system locates templates that match the names on the list. For each name, it searches the device and then searches the device class hierarchy. Zenoss Core uses the lowest template in the hierarchy that it can locate with the correct name, ignoring others of the same name that might exist further up the device class hierarchy.

### 6.2.3.1. Binding Templates

To edit the templates bound to a device:

1. From the Navigation menu, select Infrastructure.

The device list appears.

2. Select a device in the device list.

3. Select Bind Templates from  (Action menu).

The Bind Templates dialog appears.

**Figure 6.5. Bind Templates**



4. Select a template from the Available list and move it to the Selected list to bind it to the selected device.
5. Click **Save**.

### 6.2.4. Data Sources

Data sources specify which data points to collect and how to collect them. Each monitoring template comprises one or more data sources. The system provides two built-in data source types: `SNMP` and `COMMAND`. (Other data source types are provided through ZenPacks.)

- **SNMP** - Define data to be collected via SNMP by the `ZenPerfSNMP` daemon. They contain one additional field to specify which SNMP OID to collect. (Many OIDs must end in `.0` to work correctly.) Because SNMP data sources specify only one performance metric, they contain a single data point.
- **Command** - specify data to be collected by a shell command that is executed on the Zenoss Core server or on a monitored device. The `ZenCommand` daemon processes `COMMAND` data sources. A `COMMAND` data source may return one or more performance metrics, and usually has one data point for each metric.

Shell commands used with COMMAND data sources must return data that conforms to the Nagios plug-in output specification. For more information, see the section titled *Monitoring Using ZenCommand*.

### 6.2.4.1. Adding a Data Source

To add a data source to a monitoring template:

1. Select **Advanced** from the Navigation menu, and then select **Monitoring Templates**.
2. In the tree view, select the monitoring template to which you want to add a data source.
3. In the Data Sources area, select  (Add Data Source) from the Action menu.

The Add Data Source dialog appears.

4. Enter a name for the data source and select the type, and then click **Submit**.

The data source is added to the list in the Data Sources area.

5. Double-click the data source in the list.

The Edit Data Source dialog appears.

6. Enter or select values to define the data source.

### 6.2.5. Data Points

Data sources can return data for one or more performance metrics. Each metric retrieved by a data source is represented by a data point.

#### Defining Data Points

You can define data points to data sources with all source types except SNMP and VMware. Because these data source types each rely on a single data point for performance metrics, additional data point definition is not needed.

To add a data point to a data source:

1. Select **Advanced** from the Navigation menu, and then select **Monitoring Templates**.
2. In the Data Sources area, highlight the row containing a data source.
3. Select **Add Data Point** from the Action menu.

The Add Data Point dialog appears.

4. Enter a name for the data point, and then click **Submit**.

#### Note

For COMMAND data points, the name should be the same as that used by the shell command when returning data.

5. Double-click the newly added data point to edit it. Enter information or make selections to define the data point:

- **Name** - Displays the name you entered in the Add a New DataPoint dialog.
- **RRD Type** - Specify the RRD data source type to use for storing data for this data point. (Zenoss Core uses RRDTool to store performance data.) Available options are:
  - **COUNTER** - Saves the rate of change of the value over a step period. This assumes that the value is always increasing (the difference between the current and the previous value is greater than 0). Traffic counters on a router are an ideal candidate for using COUNTER.
  - **GAUGE** - Does not save the rate of change, but saves the actual value. There are no divisions or calculations. To see memory consumption in a server, for example, you might want to select this value.

### Note

Rather than COUNTER, you may want to define a data point using DERIVED and with a minimum of zero. This creates the same conditions as COUNTER, with one exception. Because COUNTER is a "smart" data type, it can wrap the data when a maximum number of values is reached in the system. An issue can occur when there is a loss of reporting and the system (when looking at COUNTER values) thinks it should wrap the data. This creates an artificial spike in the system and creates statistical anomalies.

- **DERIVE** - Same as COUNTER, but additionally allows negative values. If you want to see the rate of change in free disk space on your server, for example, then you might want to select this value.
- **ABSOLUTE** - Saves the rate of change, but assumes that the previous value is set to 0. The difference between the current and the previous value is always equal to the current value. Thus, ABSOLUTE stores the current value, divided by the step interval.
- **Create Command** - Enter an RRD expression used to create the database for this data point. If you do not enter a value, then the system uses a default applicable to most situations.

For details about the rrdcreate command, go to:

<http://oss.oetiker.ch/rrdtool/doc/rrdcreate.en.html>

- **RRD Minimum** - Enter a value. Any value received that is less than this number is ignored.
- **RRD Maximum** - Enter a value. Any value received that is greater than this number is ignored.

6. Click **Save** to save the defined data point.

## 6.2.6. Data Point Aliases

Performance reports pull information from various data points that represent a metric. The report itself knows which data points it requires, and which modifications are needed, if any, to put the data in its proper units and format.

The addition of a data point requires changing the report.

**Figure 6.6. CPU Utilization Report****CPU Utilization Report**

*For the Linux data point:  
Divide the total CPU idle percentage  
by the number of cores, and subtract  
from 100.*

*For the Windows data point:  
Report the CPU utilization unmodified.*

*Adding ESX requires adding another  
rule to fetch it and divide the value by  
100, because the utilization is reported  
on a scale from 0 to 10000.*

Device	Utilization
linux.example.com	20%
windows.example.com	34%

Total CPU idle = 320%

linux.example.com  
(Linux with 4 cores)

CPU utilization = 34%

windows.example.com  
(Windows)

CPU utilization = 4322

esx.example.com  
(ESX via VI SDK)

To allow for more flexibility in changes, some reports use *data point aliases*. Data point aliases group data points so they can be more easily used for reporting. In addition, if the data points return data in different units, then the plugin can normalize that data into a common unit.

An alias-based report looks up the data points that share a common alias string, and then uses them. This approach allows you to add data points without changing the report.

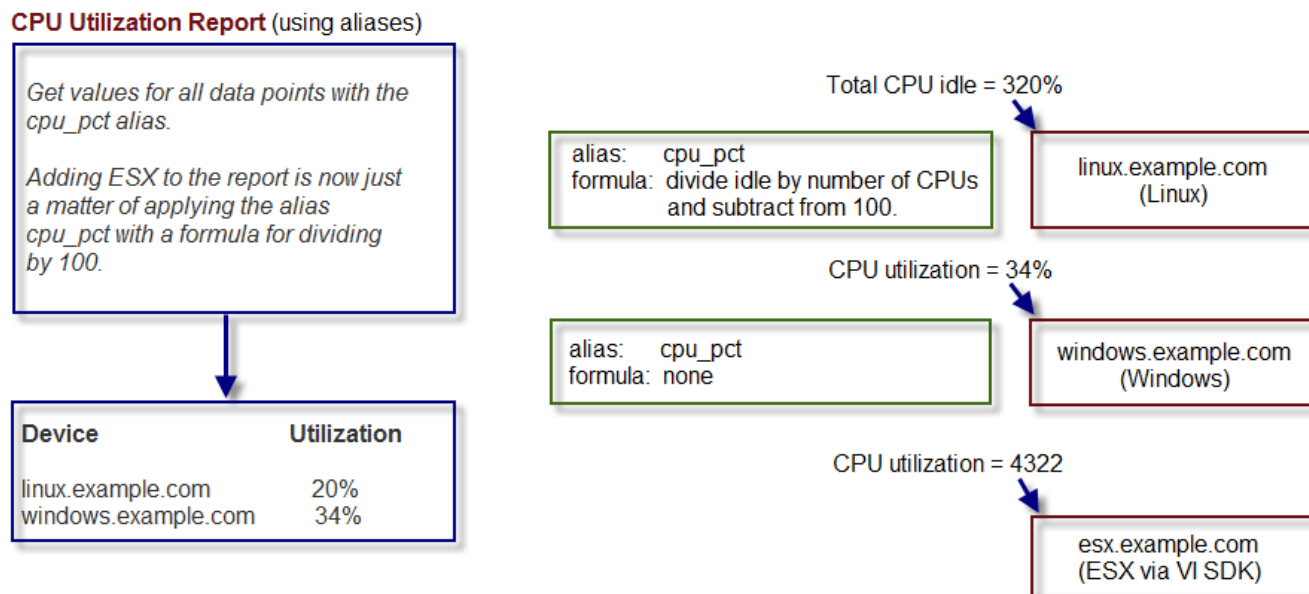
**Figure 6.7. Alias-Based CPU Utilization Report**

In the simplest cases, data from the target data points are returned in units expected by a report. For cases in which data are not returned in the same units, an alias can use an associated formula at the data point. For example, if a data point returns data in kilobytes, but the report expects data in bytes, then the formula multiplies the value by 1024.

### 6.2.6.1. Alias Formula Evaluation

The system evaluates the alias formula in three passes.

#### 6.2.6.1.1. Reverse Polish Notation

When complete, the alias formula must resolve to a Reverse Polish Notation (RPN) formula that can be used by RRDtool. For the simple conversion of kilobytes into bytes, the formula is:

```
1024 , *
```

For more information on RRDtool and RPN formulas, browse to this site:

[http://oss.oetiker.ch/rrdtool/doc/rrdgraph\\_rpn.en.html](http://oss.oetiker.ch/rrdtool/doc/rrdgraph_rpn.en.html)

#### 6.2.6.1.2. Using TALES Expressions in Alias Formulas

For cases in which contextual information is needed, the alias formula can contain a TALES expression that has access to the device as context (labeled as "here"). The result of the TALES evaluation should be an RRD formula.

For example, if the desired value is the data point value divided by total memory, the formula is:

```
${here/hw/totalMemory} , /
```

For more information on TALES, refer to the appendix in this guide titled "TALES Expressions," or to the TALES Specification 1.3, at:

<http://wiki.zope.org/ZPT/TALESSpecification13>

### 6.2.6.1.3. Using Python in Alias Formulas

You also can embed full Python code in an alias formula for execution. The code must construct a string that results in a valid RRD formula. To signal the system to evaluate the formula correctly, it must begin with:

```
__EVAL:
```

Using the same example as in the previous section (division by total memory), the formula is:

```
__EVAL:here.hw.totalMemory + "/"
```

### 6.2.6.2. Adding a Data Point Alias

To add an alias to a data point:

1. Navigate to a data source on a monitoring template.
2. Double-click a data point in the list to edit it.

The Edit Data Point dialog appears.

3. Enter the alias name and the formula.

#### Note

If the data point returns values in the desired units, then leave the Formula value blank.

**Figure 6.8. Add Data Point Alias**

4. Click **Save**.

### 6.2.6.3. Reports That Use Aliases

For information about reports that use aliases, refer to the chapter titled "Reporting."

The following table shows performance reports that use aliases, and the aliases used. To add data points to a report, add the alias, and then ensure the values return in the expected units.

#### CPU Utilization

Alias	Expected Units
loadAverage5min	Processes
cpu_pct	Percent

### 6.2.7. Thresholds

Thresholds define expected bounds for data points. When the value returned by a data point violates a threshold, the system creates an event.

### 6.2.7.1. MinMax Threshold

The system provides one built-in threshold type: the MinMax threshold. (Other threshold types are provided through ZenPacks.)

MinMax thresholds inspect incoming data to determine whether it exceeds a given maximum or falls below a given minimum. You can use a MinMax threshold to check for these scenarios:

- *The current value is less than a minimum value.* To do this, you should set only a minimum value for the threshold. Any value less than this number results in creation of a threshold event.
- *The current value is greater than a maximum value.* To do this, you should set only a maximum value for the threshold. Any value greater than this number results in creation of a threshold event.
- *The current value is not a single, pre-defined number.* To do this, you should set the minimum and maximum values for the threshold to the same value. This will be the only "good" number. If the returned value is not this number, then a threshold event is created.
- *The current value falls outside a pre-defined range.* To do this, you should set the minimum value to the lowest value within the good range, and the maximum value to the highest value within the good range. If the returned value is less than the minimum, or greater than the maximum, then a threshold event is created.
- *The current value falls within a pre-defined range.* To do this, you should set the minimum value to the highest value within the bad range, and the maximum value to the lowest value within the bad range. If the returned value is greater than the maximum, and less than the minimum, then a threshold event is created.

### 6.2.7.2. Adding Thresholds

Follow these steps to define a MinMax threshold for a data point:

1. Select Advanced from the Navigation menu, and then select Monitoring Templates.

2. In the Thresholds area, click  (Add Threshold).

The Add Threshold dialog appears.

3. Select the threshold type and enter a name, and then click **Add**.

4. Double-click the newly added threshold in the list to edit it.

The Edit Threshold dialog appears.



**Figure 6.9. Edit Threshold**

**Edit Threshold**

Name:

Type: MinMaxThreshold

DataPoints:

Available	Selected
ifInErrors_ifInErrors	ifInOctets_ifInOctets
ifInUcastPackets_ifInUcastPackets	ifOutOctets_ifOutOctets
ifOperStatus_ifOperStatus	
ifOutErrors_ifOutErrors	
ifOutOctets_test	
ifOutUcastPackets_ifOutUcastPackets	

Severity:

Enabled

Minimum Value:

Maximum Value:

Event Class:

Escalate Count:

## 5. Enter or select values to define the threshold:

- **Name** - Displays the value for the ID you entered on the Add a New Threshold dialog.
- **Data Points** - Select one or more data points to which this threshold will apply.
- **Severity** - Select the severity level of the first event triggered when this threshold is breached.
- **Enabled** - Select True to enable the threshold, or False to disable it.
- **Minimum Value** - If this field contains a value, then each time one of the select data points falls below this value an event is triggered. This field may contain a number or a Python expression.

When using a Python expression, the variable `here` references the device or component for which data is being collected. For example, an 85% threshold on an interface might be specified as:

```
here.speed * .85 / 8
```

The division by 8 is because interface speed frequently is reported in bits/second, where the performance data is bytes/second.

- **Maximum Value** - If this field contains a value, then each time one of the selected data points goes above this value an event is triggered. This field may contain a number or a Python expression.
- **Event Class** - Select the event class of the event that will be triggered when this threshold is breached.
- **Escalate Count** - Enter the number of consecutive times this threshold can be broken before the event severity is escalated by one step.

6. Click **Save** to save the newly defined threshold.

## 6.2.8. Performance Graphs

You can include any of the data points or thresholds from a monitoring template in a *performance graph*.

To define a graph:

1. Select **Advanced** from the Navigation menu, and then select **Monitoring Templates**.

2. In the Graph Definitions area, click  (Add Graph).

The Add Graph Definition dialog appears.

3. Enter a name for the graph, and then click **Submit**.

4. Double-click the graph in the list to edit it. Enter information or select values to define the graph:

- **Name** - Optionally edit the name of the graph you entered in the Add a New Graph dialog. This name appears as the title of the graph.
- **Height** - Enter the height of the graph, in pixels.
- **Width** - Enter the width of the graph, in pixels.
- **Units** - Enter a label for the graph's vertical axis.
- **Logarithmic Scale** - Select **True** to specify that the scale of the vertical axis is logarithmic. Select **False** (the default) to set the scale to linear. You might want to set the value to **True**, for example, if the data being graphed grows exponentially. Only positive data can be graphed logarithmically.
- **Base 1024** - Select **True** if the data you are graphing is measured in multiples of 1024. By default, this value is **False**.
- **Min Y** - Enter the bottom value for the graph's vertical axis.
- **Max Y** - Enter the top value for the graph's vertical axis.
- **Has Summary** - Select **True** to display a summary of the data's current, average, and maximum values at the bottom of the graph.

**Figure 6.10. Graph Definition**

**View and Edit Graph Definition**

Name:

Height:

Width:

Units:

Logarithmic Scale:

Base 1024:

Min Y:

Max Y:

Has Summary:

1. Click **Submit** to save the graph.

### 6.2.8.1. Graph Points

Graph points represent each data point or threshold that is part of a graph. You can add any number of graph points to a graph definition by adding data points or thresholds.

From the Graph Definitions area of the Monitoring Templates page:

1. Select Manage Graph Points from the Action menu.

The Manage Graph Points dialog appears.

2. From the Add menu, add a data point, threshold, or custom graph point.
3. Select values, and then click **Submit**.

the new graph point appears in the Graph Points list.

## Note

Thresholds are always drawn before other graph points.

### 6.2.8.1.1. Re-sequencing Graph Points

To re-sequence graph points, drag a graph point row in the Manage Graph Points dialog. (Click and drag from an "empty" part of the row.)

### 6.2.8.1.2. DataPoint Graph Points

DataPoint graph points draw the value of data points from the template on a graph.

#### 6.2.8.1.2.1. Adding DataPoint Graph Points

To define a DataPoint graph point:

1. From the Add menu on the Manage Graph Points dialog, select Data Point.

The Add Data Point dialog appears.

2. Select one or more data points defined in this template. On data point graph point is created for each data point you select from the list.
3. Optionally select the Include Related Thresholds option. If selected, then any graph points are created for any thresholds that have been applied to the selected data points as well.
4. Click **Submit**.

#### 6.2.8.1.2.2. Editing DataPoint Graph Points

Double-click the name of the graph point to go to its edit page. Enter information or select values to edit the graph point:

- **Name** - This is the name that appears on the Graph Definition page. By default, it appears in the graph legend.
- **Line Type** - Select Line to graph the data as a line. Select Area to fill the area between the line and the horizontal axis with the line color. Select None to use this data point for custom RRD commands and do not want it to be explicitly drawn.
- **Line Width** - Enter the pixel width of the line.
- **Stacked** - If True, then the line or area is drawn above the previously drawn data. At any point in time on the graph, the value plotted for this data is the sum of the previously drawn data and the value of this data point now. You might set this value, for example, to asses total packets if measuring packets in and packets out.
- **Format** - Specify the RRD format to use when displaying values in the graph summary. For more information on RRDTOOL formatting strings, go to:

[http://oss.oetiker.ch/rrdtool/doc/rrdgraph\\_graph.en.html](http://oss.oetiker.ch/rrdtool/doc/rrdgraph_graph.en.html)

- **RPN** - Optionally enter an RPN expression that alters the value of the data being graphed for the data point. For example, if the data is stored as bits, but you want to graph it as bytes, enter an RPN value of "8,/" to divide by 8. For more information about RRDTOOL RPN notation, go to:

<http://oss.oetiker.ch/rrdtool/tut/rpntutorial.en.html>

- **Limit** - Optionally specify a maximum value for the data being graphed.
- **Consolidation** - Specify the RRD function used to graph the data point's data to the size of the graph. Most of the time, the default value of AVERAGE is appropriate.
- **Color** - Optionally specify a color for the line or area. Enter a six-digit hexadecimal color value with an optional two-digit hex value to specify an alpha channel. An alpha channel value is only used if 'stacked' is True.
- **Legend** - Name to use for the data in the graph legend. By default, this is a TALES expression that specifies the graph point name. The variables available in this TALES expression are here (the device or component being graphed) and graphPoint (the graph point itself).
- **Available RRD Variables** - Lists the RRD variables defined in this graph definition. These values can be used in the RPN field.

### 6.2.8.1.3. Editing Threshold Graph Points

Threshold graph points graph the value of thresholds from the template.

To edit a threshold graph point, double-click it in the list:

You can edit values for Name, Color, and Legend for a threshold graph point. Refer to the definitions in the section titled Editing DataPoint Graph Points for more information.

### 6.2.8.1.4. Editing Custom Graph Points

Custom graph points allow you to insert specific RRD graph commands into the graph definition.

For details on DEF, CDEF, and VDEF commands, go to:

[http://oss.oetiker.ch/rrdtool/doc/rrdgraph\\_data.en.html](http://oss.oetiker.ch/rrdtool/doc/rrdgraph_data.en.html)

For details on other RRD commands, go to:

[http://oss.oetiker.ch/rrdtool/doc/rrdgraph\\_graph.en.html](http://oss.oetiker.ch/rrdtool/doc/rrdgraph_graph.en.html)

### 6.2.8.1.5. Setting Up ping RTT and Packet Loss Graphs

You can use zenping to produce ping round-trip time (RTT) and packet loss graphs.

**Figure 6.11. Ping Data Source**

The screenshot displays the Zenoss Monitoring Templates interface. The 'Data Sources' section is active, showing a list of data points for the 'Ping' data source. The 'Thresholds' section is also visible, showing a threshold for 'high utilization'. The 'Graph Definitions' section is also visible, showing a graph definition for 'Ping Round-Trip Time (RTT)'.

Data Points by Data Source	Source	Enabled	Type
ifInErrors	1.3.6.1.2.1.2.2.1.14	true	SNMP
ifInOctets	1.3.6.1.2.1.2.2.1.10	true	SNMP
ifInUcastPackets	1.3.6.1.2.1.2.2.1.11	true	SNMP
ifOperStatus	1.3.6.1.2.1.2.2.1.8	true	SNMP
ifOutErrors	1.3.6.1.2.1.2.2.1.20	true	SNMP
ifOutOctets	1.3.6.1.2.1.2.2.1.16	true	SNMP
ifOutUcastPackets	1.3.6.1.2.1.2.2.1.17	true	SNMP
Ping	Ping	true	PING
Ping.rtt			GAUGE
Ping.rtt_losspct			GAUGE

1. On your ethernetCsmacd templates (or other interface templates), add a data source named Ping, of type PING.

The data source is added, and automatically includes several rtt data points.

2. Add a graph definition for each data point.

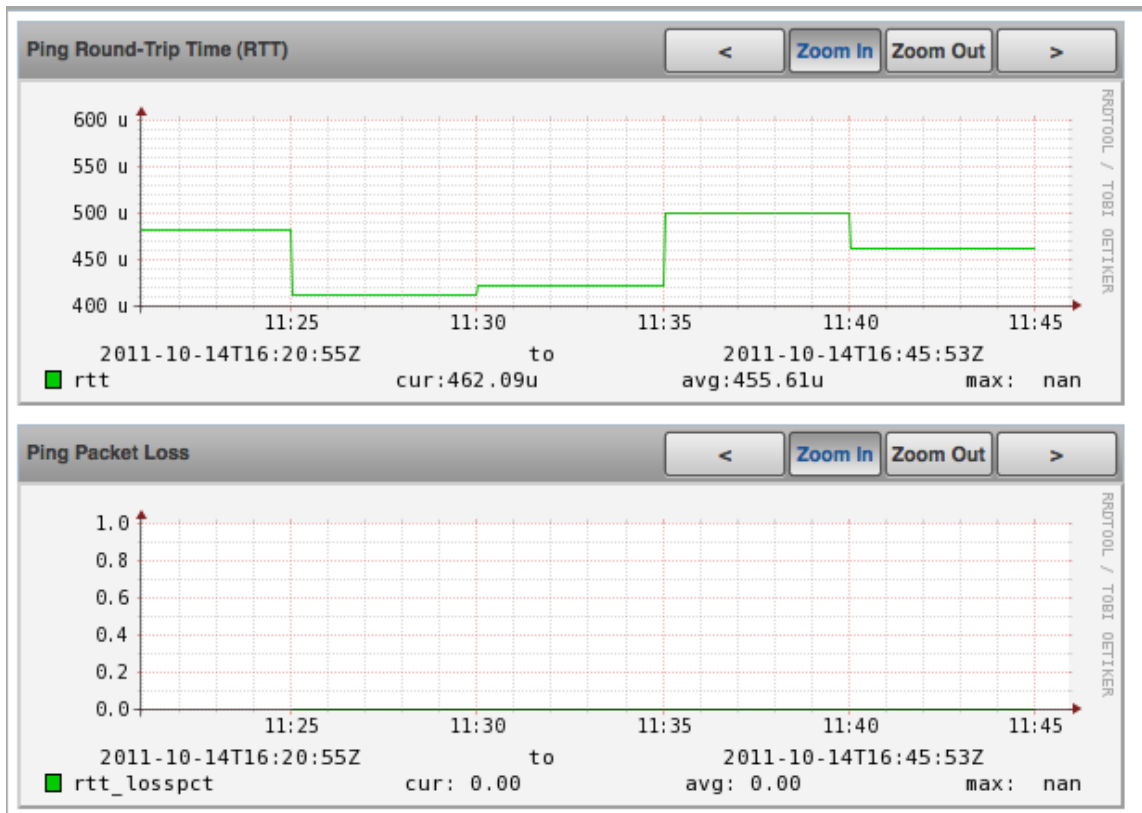
**Figure 6.12. Ping Graph**

Available statistics for data points include:

- sent
- rcvCount
- loss
- rtt
- rtt\_max
- rtt\_min
- rtt\_avg
- rtt\_stddev
- rtt\_losspct

### 6.2.8.2. Custom Graph Definition

Custom graph definitions allow you to specify your own set of RRD commands to draw a graph. The graph points specified are used to define data that is available to the commands you specify here; however, the graph points are not drawn unless you explicitly draw them with the commands you specify. The Available RRD Variables lists the values defined by the graph points that are available for use.

To access custom graph definitions, select Custom Graph Definition from the Action menu in the Graph Definitions area.

### 6.2.8.3. Graph Commands

Graph Commands show an approximate representation of the RRD commands that will be used to draw a graph. This representation provides helpful debugging information when using custom graph points or custom graph definitions.

To view graph commands, select Graph Commands from the Action menu in the Graph Definitions area.

## 6.3. Monitoring Using ZenCommand

Read the following sections for more information about monitoring using ZenCommand.

### 6.3.1. About ZenCommands

Zenoss Core has the ability to run Nagios® and Cacti plug-ins through the ZenCommand process. ZenCommand can run plugins locally and remotely by using a native SSH transport. When run, the system tracks the return code of each plug-in and then creates events with plug-in output. Additionally, it can track performance information from a plug-in.

**Figure 6.13. Running ZenCommands**

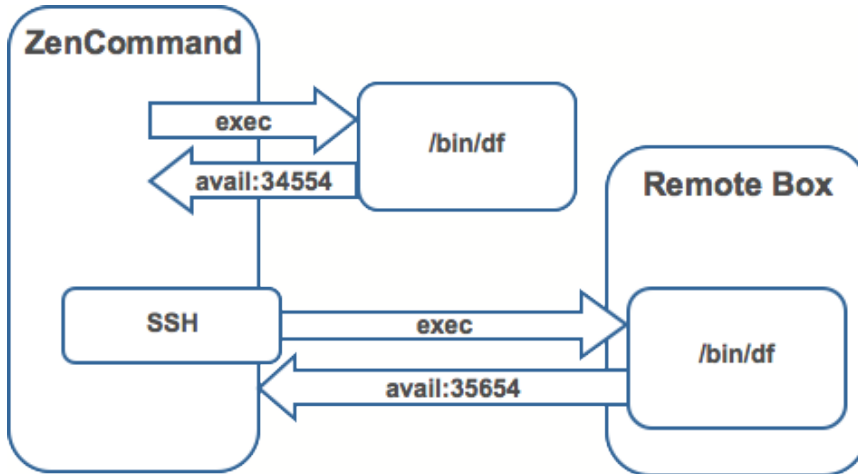

### 6.3.2. Example: Writing a ZenCommand (check\_http example)

You can use a ZenCommand plugin (check\_http) to check for specific content of a Web page. (This implicitly checks for server/page 200 status as well.)

The following example procedure shows how to set up a ZenCommand plugin to check specific content. The steps show how to test the plugin, and then integrate it.

1. As the zenoss user, test the plugin from the command line. Enter the following command to test the product directory:

```
$ZENHOME/libexec/check_http -H www.zenoss.com
```

If the check\_http command is correct, the output will look similar to the following.

```
HTTP OK HTTP/1.0 200 OK - 0.723 second response time |time=0.722758s;;;0.000000 size=7932B;;0
```

## Note

The `check_http -h` command displays all plugin options.

2. Add the device you want to check (one running a "www" Web site) to the Zenoss Core system, setting the discovery protocol to "none."
3. Navigate to the device, and then select Monitoring Templates from the left panel.
4. Create a local copy.

The default device template is overridden with the device template specific to this device.

5. In the template, remove the `sysUpTime` data source. (In this example, SNMP is not used for the device.)
6. Add a new description to the template.
7. Add a new data source called `rootWebCheck`.
8. In the `rootWebCheck` data source, set the following variables:
  - Source Type = COMMAND
  - Component = `rootWebCheck`
  - Cycle Time = 30
9. Debug your ZenCommand by running `zencommand` in the foreground with debugging on:

```
zencommand run -d www.website.com -v10
```

Where `www.website.com` is the site you want to monitor.

The command template field is a TALEX expression. You can make substitutions in the command that will make it generic for any device added to this class.

10. Set the `-H` flag to the IP of the device against which this command will be run, as follows:

```
check_http -H ${here/manageIp}
```

11. Add a check looking for content on the page. The `-r` flag will run a regular expression against the Web page to check for text.

```
check_http -H ${here/manageIp} -r textstring1
```

Where *textstring1* is text you know is on the resulting Web page.

12. For this example, the command should be generic. Make a custom field for the regex that can be changed per device. Set the default to `.*`, which will match everything. Go to `/Devices/Custom Schema` and add a new field:
  - Label = Web Match Regex
  - Name = `cWebMatchRegex`
  - Type = string
  - Default = `.*`
  - Visible = True



13. Return to the template and change the command to be.

```
check_http -H ${here/manageIp} -r ${here/cWebMatchRegex}
```

14. Add the regex value into cWebMatchRegex (used in the example above).

15. Test the ZenCommand from the command line.

### 6.3.3. Example: Collect Data from A ZenCommand

To collect and display data from the ZenCommand check\_http example, you can log the data to see something like response time in a graphical format.

1. Navigate to /Web/Device template.
2. Go to the data source created in the check\_http example.
3. Add a data point named "time." (No modifications are needed to the data point.)
4. Test the command again. You should see a log message that starts with:

```
DEBUG:zen.zencommand:storing responseTime = 1.0
```

5. Make a graph to display the data. In the device template, create a graph called "Web Response Time."
6. For this graph, set the following values:
  - Data Sources = rootWebCheck\_responseTime
  - Units = Seconds
  - Min Y = 0
7. Go to Graphs for the device www.website.com (the Web site you were using to check) to see the graph. Graph data will not appear until collection is run several times. Restart zencommand so that the new configuration takes effect immediately.

### 6.3.4. Plugin Format for ZenCommands

Nagios® plugins are configured by using a command template that is much like the RRDTemplates used for performance monitoring.

A template named "Device" will bind to all devices below the template definition. Within each template is a list of commands that will run. The commands can be any program that follows the Nagios® plug-in standard. Inputs are command line arguments; output is the first line of stdout, plus a return code.

#### Note

Zenoss Core return codes differ from Nagios return codes, as follows:

Value	Zenoss Core	Nagios
0	Clear	OK
1	Data Source	WARNING
2	Data Source+1	CRITICAL

Value	Zenoss Core	Nagios
3	Data Source	UNKNOWN

For complete information about Nagios plugin guidelines, browse to this location:

<http://nagiosplug.sourceforge.net/developer-guidelines.html>

A Nagios® command has several fields:

- name – Specifies the name of the command object.
- enabled – Indicates whether this command should be used on a given device.
- component – Specifies the component name to use when zencommand sends events to the system.
- event class – Specifies the event class to use when sending events to the system.
- severity – Sets the default severity to use when sending events to the system.
- cycle time – Sets the frequency a command should be run (in seconds).
- command template – Specifies the command to run.

The command template string is built by using Zope TALEs expressions. Several variables are passed when evaluating the template. They are:

- zCommandPath – Path to the zencommand plug-ins on a given box it comes from the configuration property zCommandPath. zCommandPath is automatically added to a command if a path is absent from the beginning of the command.
- devname – Device name of the device against which the command is being evaluated.
- dev – Device object against which the command is being evaluated.
- here – Context of evaluation. For a device, this is equivalent to dev for a component (such as a file system or interface). This is the component object.
- compname – If this command evaluates against a component, specifies its name as a string.
- now – Current time.

Template values are accessed like shell variables. They are the same as the expression syntax used in the appendix titled TALEs Expressions (in this guide).

## Examples

Run an http check against all devices by using the URL /zport/dmd:

```
check_http -H ${devname} -u /zport/dmd
```

In a template named FileSystem, the following command will run against all file systems on a device:

```
check_disk -w 10% -c 5% -p ${compname}
```

### 6.3.5. Testing ZenCommands

You can test ZenCommand data sources by using the zentestcommand shell script.

From the command line, run:

```
zentestcommand -d DeviceID --datasource=DataSourceName
```

where *DeviceID* is the device on which you want to run the command, and *DataSourceName* is the name of a data source on a template associated with the device.

The `zentestcommand` script prints the results of the command to standard output.

## 6.4. SNMP Monitoring

OID represent the data points where the data for the graphs comes from. Sometimes the reason that a graph is not appearing is because the OID for the particular graph is not valid for the device. You can test this validity using the command line to see if you can return a value. To test the validity of an OID data point giving performance data:

1. SSH to the Zenoss Core instance.

Use Username: root

Password: zenoss

2. Run the command `snmp get` for one of the OIDs

In this case, use the command:

```
$ snmpget -v1 -cpublic build .1.3.6.1.4.1.2021.4.14.0
```

If the OID is valid it will return a value.

Here are some basic SNMP commands to gather certain information.

- a. Walk a basic system MIB.

```
snmpwalk -v1 -cpublic <device name> system
```

- b. Walk an interface description

```
snmpwalk -v1 -cpublic <device name> ifDescr
```

- c. Get a single value.

```
snmpget -v1 -cpublic <device name> ifDescr.2
```

- d. Detailed description of an OID value.

```
snmptranslate -Td RFC1213-MIB::ifDescr
```

- e. Convert a name to a raw OID.

```
snmptranslate -On RFC1213-MIB::ifDescr
```

- f. Convert a raw OID to a short name

```
snmptranslate -OS .1.3.6.1.2.1.2.2.1.2
```

## 6.5. Monitoring Devices Remotely Through SSH

You can monitor devices remotely through SSH. Follow the steps in the following sections to set up remote monitoring. Refer to the *Extended Monitoring* guide for additional information.

## 6.5.1. Changing Zenoss Core to Monitor Devices Remotely Using SSH

You must edit system properties for the group where you want to collect remote information using SSH.

1. Navigate to the device class path you want to monitor remotely. You can apply this monitoring for a device or a device class path.
2. Change the configuration properties value for the group. After selecting the device class, click **Details**, and then select Configuration Properties.

The Configuration Properties page appears.

**Figure 6.14. Device Class Configuration Properties**

Configuration Properties			
Property	Value	Type	Path
zCollectorClientTimeout	180	int	/
zCollectorDecoding	latin-1	string	/
zCollectorLogChanges	True	boolean	/
zCollectorPlugins	Edit	lines	/Discovered
zCommandCommandTimeout	15.0	float	/
zCommandCycleTime	60	int	/
zCommandExistenceTest	test -f %s	string	/
zCommandLoginTimeout	10.0	float	/
zCommandLoginTries	1	int	/
zCommandPassword		password	/
zCommandPath	/usr/local/zenoss/libexec	string	/
zCommandPort	22	int	/
zCommandProtocol	ssh	string	/
zCommandSearchPath		lines	/
zCommandUsername		string	/
zDeviceTemplates	Device MySQL	lines	/
zEnablePassword		password	/
zFileSystemMapIgnoreNames		string	/

You must make changes to the following configuration properties:

- zCollectorPlugins
- zCommandPassword
- zCommandPath
- zCommandUsername
- zSnmplibIgnoreNames

The following table lists sample values set up for remote devices. These have a pre-shared key (with no password) set up from the collector to the remote boxes. (It also can use password authorization if the password is entered into zCommandPassword.)

Configuration Properties	Value
zCollectorPlugins	snmp portscan

Configuration Properties	Value
zCommandPassword	The SSH password for the remote machine.
zCommandPath	The path to zenplugin.py
zCommandUsername	The SSH user name for the remote machine.
zSnmpMonitorIgnore	True

Two passes are required for full modeling. The first pass obtains the platform type (so that the system knows which plugins to run). The second pass provides detailed data on interfaces and file systems.

Run the command:

```
$ zenmodeler run -d enter_server_name_here
```

Run the command a second time to use the plugins the command gathered on the first pass.

## 6.5.2. Using the Predefined /Server/Cmd Device Class

The /Server/Cmd device class is an example configuration for modeling and monitoring devices using SSH. The configuration properties have been modified (as described in the previous sections), and device, file system, and Ethernet interface templates that gather data over SSH have been created.

You can use this device class as a reference for your own configuration; or, if you have a device that needs to be modeled or monitored via SSH/Command, you can place it under this device class to use the pre-configured templates and configuration properties. You must set the zCommandUsername and zCommandPassword properties to the appropriate SSH login information for each device.

## 6.6. Monitoring Windows Devices

### 6.6.1. Device Preparation for Windows Devices

WMI is used to monitor the Windows event log and state of Windows services.

Before you can monitor Windows devices, you must ensure that:

- The Distributed Component Object Model (DCOM) is enabled for WMI connections
- The host name of the system collector does not exceed fifteen characters

Optionally, you can use SNMP Informant™ to collect CPU, memory, and disk I/O statistics. SNMP Informant agents collect information from Windows devices via WMI on the server where they are installed, and then convert system, state, and operational data into SNMP OIDs for broadcast. The system can then process the SNMP OID information and generate events and alerts based on this information. See the section titled Monitoring Windows Performance with SNMP Informant (in this chapter) for more information.

### 6.6.2. Setting Windows Configuration Properties

You must set the following configuration properties to collect information from Windows servers. In Zenoss Core, navigate to the configuration properties for each device, and then set the appropriate values for:

- **zWmiMonitorIgnore** - Turns on or off all WMI monitoring. Set the value of Ignore to False to turn on Windows monitoring.

You should set this property at the Server/Windows class level, so that any device placed in this class has Windows monitoring automatically enabled.

- **zWinUser** - Must be set as the local admin. The format for zWinUser is:
  - .\Username - The format to use when the account is a local account.
  - DOMAIN\Username - The format for a Domain account.
- **zWinPassword** - Enter the password used to remotely log in to the Windows machine.

### 6.6.3. Testing WMI on a Windows Server

Follow these steps to test the WMI connections on the Windows server:

1. Run wbemtest.
2. Click “Connect...”
3. In the Namespace field, enter:  

```
\\HOST\root\cimv2
```
4. Enter login information in the User and Password fields.
5. Click **Query**.
6. Enter “select \* from win32\_service” to return a dialog with a list of services on the device.

### 6.6.4. Optional Windows Configuration

The system can gather additional, detailed OS and hardware information from Windows devices if you have these agents installed on your Windows device:

- Dell Open Manage Agent
- HP Insight Management Agent

### 6.6.5. Modeling Services on Windows Devices

Zenoss Core uses ZenWin to perform Windows Service Monitoring over WMI. ZenWin monitors the up and down availability of Windows services.

The WinServiceMap WMI plugin is included in zCollectorPlugins on the /Server/Windows device class. WinServiceMap retrieves all services that can be monitored on a device, regardless of whether it is up or down.

Windows services are (by default) not monitored. To monitor a specific Windows service, follow these steps:

1. Navigate to Infrastructure > Windows Services.
2. Select the service you want to monitor from the list in the left panel.
3. Select Set Local Value for Enable Monitoring? (zMonitor), and then click **Save**.

### 6.6.6. Collecting Windows Event Log Events

The system uses ZenEventLog to collect WMI event log events. Enable the following configuration properties to define how Windows event log events are processed and monitored:

- **zWinEventlog** - Tells the system whether or not to read the event log.
- **zWinEventlogMinSeverity** - Sets the minimum severity to collect from the Windows event log. The lowest number indicates the highest severity (1 is the most severe; 5 is least severe).
- **zWinEventlogClause** - Allows for specific queries, per device, on the Windows event log. These fields in the TargetInstance results entries are available:
  - Category
  - CategoryString
  - ComputerName
  - Data
  - EventCode
  - EventIdentifier
  - EventType
  - InsertionStrings
  - Logfile
  - Message
  - RecordNumber
  - SourceName
  - TimeGenerated
  - TimeWritten
  - Type
  - User

An example zWinEventlogClause that allows for only Application logs to be queried is:

```
TargetInstance.Logfile = "Application"
```

For testing, the command line option testClause allows you to override the device properties at the command line. For example, to see all events and ignore the zWinEventlogClause property, use the following:

```
zeneventlog run -v10 -d deviceName --testClause=''
```

The zWinEventlogClause starts with this WQL:

```
SELECT * FROM __InstanceCreationEvent
WHERE TargetInstance ISA 'Win32_NTLogEvent'
AND TargetInstance.EventType <= zWinEventlogMinSeverity
```

For example, to select a particular ID at a lower log level:

```
(TargetInstance.EventCode = 6005 or TargetInstance.EventType <=2)
```

The full WQL query is:

```
SELECT * FROM __InstanceCreationEvent
WHERE TargetInstance ISA 'Win32_NTLogEvent'
AND TargetInstance.EventType <= 3
AND (TargetInstance.EventCode = 6005 or TargetInstance.EventType <=2)
```

## 6.6.7. Monitoring Windows Performance with SNMP Informant

Zenoss Core can use information from SNMP Informant to collect SNMP information from Windows devices.

Install the free version of SNMP Informant from this location:

<http://www.snmp-informant.com>

To make sure SNMP Informant is running and set up correctly, run this command to walk the SNMP Informant MIB:

```
snmpwalk -v1 -c<community> <server> 1.3.6.1.4.1.9600
```

This command will return some performance information if SNMP Informant is configured and running correctly.

Once this is configured properly, the system gathers and uses SNMP information the same as any other device sending SNMP traps.

## 6.6.8. Running winexe Commands on Windows Servers

You can use winexe commands to run commands on monitored Windows servers from within the system.

Usage:

```
$ZENHOME/bin/winexe [options] //host [command]
```

Options	Use
--uninstall	Uninstall winexe service after remote execution.
--reinstall	Reinstall winexe service before remote execution.
--system	Use SYSTEM account.
--runas=[DOMAIN\]USERNAME%PASSWORD	Run as user (IMPORTANT! password is sent in cleartext over net).

Help Options	Use
-.?, --help	Show this help message.
--usage	Display brief usage message.

Common samba options	Use
-d, --debuglevel=DEBUGLEVEL	Set debug level.
--debug-stderr	Send debug output to STDERR.
-s, --configfile=CONFIGFILE	Use alternative configuration file.
--option=name=value	Set smb.conf option from command line.
-l, --log-basename=LOGFILEBASE	Basename for log/debug files.
--leak-report	enable talloc leak reporting on exit.
--leak-report-full	enable full talloc leak reporting on exit.



Common samba options	Use
-V, --version	Print version.

Connection Options	Use
-R, --name-resolve=NAME-RESOLVE-ORDER	Use these name resolution services only.
-O, --socket-options=SOCKETOPTIONS	Socket options to use.
-n, --netbiosname=NETBIOSNAME	Primary netbios name.
-W, --workgroup=WORKGROUP	Set the workgroup name.
--realm=REALM	Set the realm name.
-i, --scope=SCOPE	Use this Netbios scope.
-m, --maxprotocol=MAXPROTOCOL	Set max protocol level.

Authentication Options	Use
-U, --user=[DOMAIN \\]USERNAME[%PASSWORD]	Set the network user name.
-N, --no-pass	Do not ask for a password.
--password=STRING	Password
-A, --authentication-file=FILE	Get the credentials from a file.
-S, --signing=on off required	Set the client signing state.
-P, --machine-pass	Use stored machine account password (implies -k).
--simple-bind-dn=STRING	DN to use for a simple bind.
-k, --kerberos=STRING	Use Kerberos.
--use-security-mechanisms=STRING	Restricted list of authentication mechanisms available for use with this authentication.

---

# Chapter 7. Event Management

## 7.1. About Events

Events, and the graphs generated from performance monitoring, are the primary operational tools for understanding the state of your environment. This chapter:

- Defines events
- Describes important event management system features, such as de-duplication and auto-clear correlation
- Provides information about managing events through the user interface
- Explains how to manage notifications

### 7.1.1. Basic Event Fields

To enter the event management system, an event must contain values for the device, severity, and summary fields. If an event is missing any of these fields, then Zenoss Core rejects it.

Basic event fields are:

- device
- ipAddress
- eventState
- severity
- summary
- message
- evid

#### 7.1.1.1. device and ipAddress Fields

The device field is a free-form text field that allows up to 255 characters. Zenoss Core accepts any value for this field. If the device field contains an IP address, then the system queries for devices with a matching address. If it finds a match, it changes the device field to the found device identifier.

The ipAddress field is a free-form text field. This field is not required. If the system cannot successfully locate a device based on the event's device field content, it attempts to find the device based the event ipAddress field content, if present.

Zenoss Core automatically adds information to incoming events that match a device. Fields added are:

- **prodState** - Specifies the device's current production state.
- **Location** - Specifies the location (if any) to which the device is assigned.
- **DeviceClass** - Classifies the device.

- **DeviceGroups** - Specifies the groups (if any) to which the device is assigned.
- **Systems** - Systems (if any) to which the device is assigned.
- **DevicePriority** - Priority assigned to the device.

For more information about these fields, refer to the chapters titled "Production States and Maintenance Windows" and "Organizers and Path Navigation."

### 7.1.1.2. eventState Field

The eventState field defines the current state of an event. This field is often updated after an event has been created. Values for this numeric field are 0-6, defined as follows:

Number	Name	Description
0	New	
1	Acknowledged	
2	Suppressed	
3	Closed	State given to an event that was closed as the result of a user action.
4	Cleared	State given to an event that was cleared by a corresponding clear event.
5	Dropped	State given to an event that was dropped via an event transform. These events are never persisted by the system.
6	Aged	State given to an event that was automatically closed by the system according to the severity and last seen time of the event.

### 7.1.1.3. severity Field

The severity field defines the severity of the event. Values for this numeric field are 0-5, defined as follows:

Number	Name	Color
0	Clear	Green
1	Debug	Grey
2	Info	Blue
3	Warning	Yellow
4	Error	Orange
5	Critical	Red

### 7.1.1.4. summary and message Fields

The summary and message fields are free-form text fields. The summary field allows up to 255 characters. The message field allows up to 4096 characters. These fields usually contain similar data.

The system handles these fields differently, depending on whether one or both are present on an incoming event:

- If only summary is present, then the system copies its contents into message and truncates summary contents to 128 characters.
- If only message is present, then the system copies its contents into summary and truncates summary contents to 128 characters.
- If summary and message are both present, then the system truncates summary contents to 128 characters.

As a result, data loss is possible only if the message or summary content exceeds 65535 characters, or if both fields are present and the summary content exceeds 128 characters.

To ensure that enough detail can be contained within the 128-character summary field limit, avoid reproducing information in the summary that exists on other fields (such as device, component, or severity).

## 7.1.2. Other Fields

Events include numerous other standard fields. Some control how an event is mapped and correlated; others provide information about the event.

The following table lists additional event fields.

Field	Description
dedupid	Dynamically generated fingerprint that allows the system to perform de-duplication on repeating events that share similar characteristics.
component	Free-form text field (maximum 255 characters) that allows additional context to be given to events (for example, the interface name for an interface threshold event).
eventClass	Name of the event class into which this event has been created or mapped.
eventKey	Free-form text field (maximum 128 characters) that allows another specificity key to be used to drive the de-duplication and auto-clearing correlation process.
eventClassKey	Free-form text field (maximum 128 characters) that is used as the first step in mapping an unknown event into an event class.
eventGroup	Free-form text field (maximum 64 characters) that can be used to group similar types of events. This is primarily an extension point for customization. Currently not used in a standard system.
stateChange	Last time that any information about the event changed.
firstTime	First time that the event occurred.
lastTime	Most recent time that the event occurred.
count	Number of occurrences of the event between the firstTime and lastTime.
prodState	Production state of the device, updated when an event occurs. This value is not changed when a device's production state is changed; it always reflects the state when the event was received by the system.
agent	Typically the name of the daemon that generated the event. For example, an SNMP threshold event will have zenperfsnmp as its agent.
DeviceClass	Device class of the device that the event is related to.
Location	Location of the device that the event is related to.
Systems	Pipe-delimited list of systems that the device is contained within.
DeviceGroups	Pipe-delimited list of systems that the device is contained within.
facility	Only present on events coming from syslog. The syslog facility.

Field	Description
priority	Only present on events coming from syslog. The syslog priority.
ntheid	Only present on events coming from Windows event log. The NT Event ID.
ownerid	Name of the user who acknowledged this event.
clearid	Only present on events in the archive that were auto-cleared. The evid of the event that cleared this one.
DevicePriority	Priority of the device that the event is related to.
eventClassMapping	If this event was matched by one of the configured event class mappings, contains the name of that mapping rule.
monitor	In a distributed setup, contains the name of the collector from which the event originated.

### 7.1.3. Details

In addition to the standard fields, the system also allows events to add an arbitrary number of additional name/value pairs to events to give them more context.

### 7.1.4. De-Duplication

Zenoss Core uses an event "de-duplication" feature, based on the concept of an event's fingerprint. Within the system, this fingerprint is the "dedupid." All of the standard events that the system creates as a result of its polling activities are de-duplicated, with no setup required. However, you can apply de-duplicating to events that arrive from other sources, such as syslog, SNMP traps, or a Windows event log.

The most important de-duplication concept is the *fingerprint*. An event's fingerprint (or dedupid) is composed of a pipe-delimited string that contains these event fields:

- device
- component (can be blank)
- eventClass
- eventKey (can be blank)
- severity
- summary (omitted from the dedupid if eventKey is non-blank)

When the component and eventKey fields are blank, a dedupid appears similar to:

```
www.example.com||/Status/Web|4|WebTx check failed
```

When the component and eventKey fields are present, a dedupid appears similar to:

```
router1.example.com|FastEthernet0/1|Perf/Interface|threshName
```

When a new event is received by the system, the dedupid is constructed. If it matches the dedupid for any active event, the existing event is updated with properties of the new event occurrence and the event's count is incremented by one, and the lastTime field is updated to be the created time of the new event occurrence. If it does not match the dedupid of any active events, then it is inserted into the active event table with a count of 1, and the firstTime and lastTime fields are set to the created time of the new event.

The following illustration depicts a de-duplication scenario in which an identical event occurs three times, followed by one that is different in a single aspect of the dedupid fingerprint.

**Figure 7.1. Event De-Duplication**

	Event	dedupid	count
Warning Threshold	device: router1 eventClass: /Perf/CPU eventKey: cpuThresh severity: 3	router1ll/Perf/CPUcpuThresholdl3	1
Warning Threshold		router1ll/Perf/CPUcpuThresholdl3	2
Warning Threshold		router1ll/Perf/CPUcpuThresholdl3	3
Error Threshold	device: router1 eventClass: /Perf/CPU eventKey: cpuThresh severity: 4	router1ll/Perf/CPUcpuThresholdl4	1

If you want to change the way de-duplication behaves, you can use an event transform to alter one of the fields used to build the dedupid. You also can use a transform to directly modify the dedupid field, for more powerful cross-device event de-duplication.

### 7.1.5. Auto-Clear Correlation

The auto-clearing feature is similar to the de-duplication feature. It also is based on the event's fingerprint. The difference is which event fields make up the fingerprint, and what happens when a new event matches an existing event's fingerprint.

All of the standard events created as a result of polling activities do auto-clearing by themselves. As with de-duplication, you would invoke auto-clearing manually only to handle events that come from other sources, such as syslog, a Windows event log, or SNMP traps.

If a component has been identified for the event, then the auto-clear fingerprint consists of these fields:

- If component UUID exists:
  - component UUID
  - eventClass (including zEventClearClasses from event class configuration properties)
  - eventKey (can be blank)
- If component UUID does not exist:
  - device
  - component (can be blank)
  - eventKey (can be blank)
  - eventClass (including zEventClearClasses from event class configuration properties)

When a new event comes into the system with a special 0 (Clear) severity, Zenoss Core checks all active events to see if they match the auto-clear fingerprint of the new event. All active events that match the auto-clear fingerprint are

updated with a Cleared state, and the clearid field is set to the UUID of the clear event. After a configurable period of time, all events in a closed state (Closed, Cleared, and Aged) are moved from the active events table to the event archive.

If an event is cleared by the clear event, it is also inserted into the active events table with a status of Closed; otherwise, it is dropped. This is done to prevent extraneous clear messages from filling your events database.

The following illustration depicts a standard ping down event and its associated clear event.

**Figure 7.2. Event Auto-Clear**

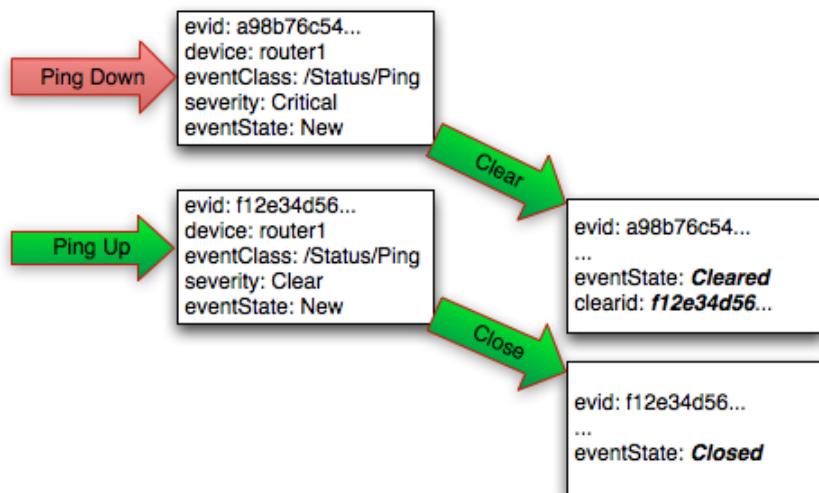

If you need to manually invoke the auto-clearing correlation system, you can use an event transform to make sure that the clear event has the 0 (Clear) severity set. You also need to ensure that the device, component, and eventClass fields match the events you intend to clear.

## Note

Avoid making clear events too generic; otherwise, you may inadvertently clear a wider range of events than you intend.

## 7.1.6. Event Consoles

Zenoss Core features multiple event consoles that allow you to view and manage events. Each console shows different events subsets, depending on your current context.

Event consoles are:

- **Master** - To access this console, click Events on the Navigation menu. You can view all events from this console.
- **Contextual** - Contextual event consoles are found throughout the system. Each time you see an Events selection for a device, device organizer, component, or event class, you can view event information that has been automatically filtered to show events specific to the current context.

### 7.1.6.1. Master Event Console

The master event console is the system's central nervous system, enabling you to view and manage events. It displays the repository of all events that have been collected by the system.

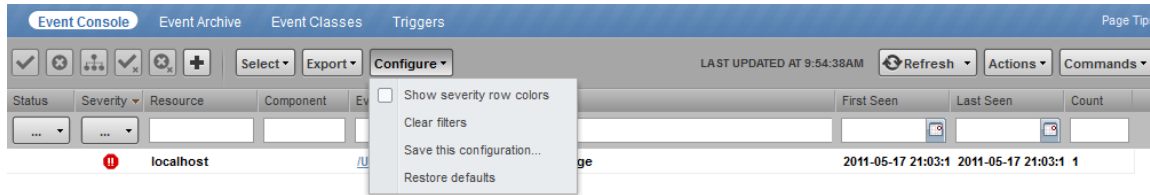
**Figure 7.3. Event Console**

The following procedures provide more information about using the event console to:

- Customize data (columns)
- Select, sort and filter events
- Work with live search
- Save or refresh a view
- View event details
- Acknowledge events
- Return events to new status
- Classify events
- Close active events or return them to active status
- Export event data
- Create events

#### 7.1.6.1.1. Customizing the Event Console

You can add or delete data columns to customize your event console view. Hover over a column header to display its control, and then select Columns > *Name*.



Figure 7.4. Customize Event Console

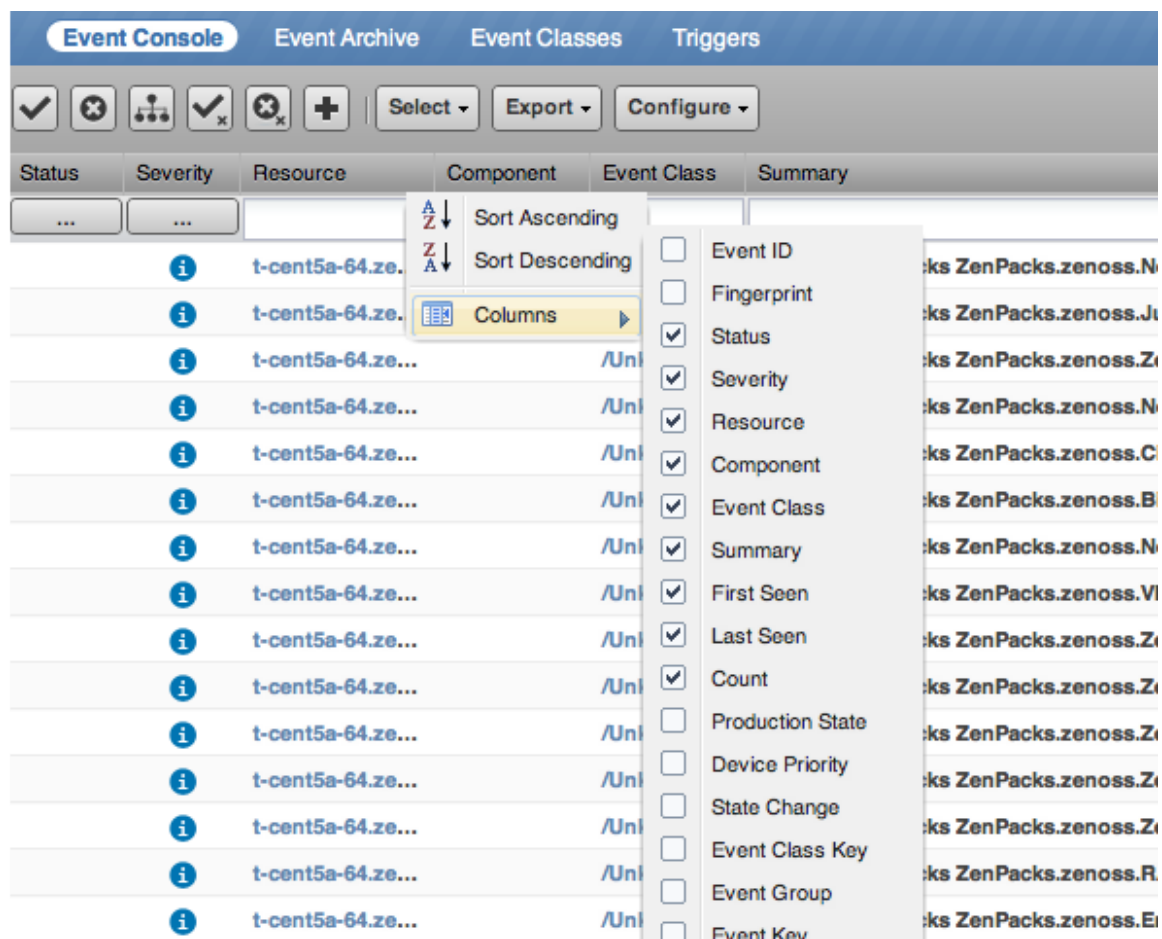

#### 7.1.6.1.2. Selecting Events

To select one or more events in the event console, you can:

- Click a row to select a single event
- Ctrl-Click rows to select multiple events, or Shift-Click to select a range of events

#### 7.1.6.1.3. Sorting and Filtering Events

To customize your view, you can sort and filter events by any column that appears in the master event console.

To sort events, click a column header. Clicking the header toggles between ascending and descending sort order.

Filter options appear below each column header.

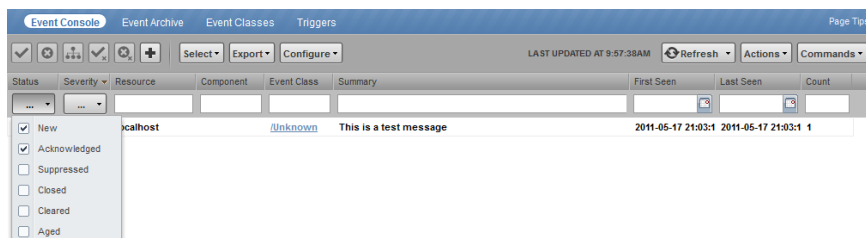
**Figure 7.5. Event Console Filter Options**

You can filter the events that appear in the list in several ways, depending on the field type. Date fields (such as First Seen and Last Seen) allow you to enter a value or use a date selection tool to limit the list. For other fields, such as Device, Component, and Event Class, enter a match value to limit the list.

The Count field allows you to filter the list when compared to a value. To search on count:

- $N$  - Displays events with a count equal to  $N$ .
- $:N$  - Displays events with a count less than or equal to  $N$ .
- $M:N$  - Displays events with a count between  $M$  and  $N$  (inclusive).
- $M:$  - Displays events with a count greater than or equal to  $M$ .

To clear filters, select **Configure > Clear filters**.

#### 7.1.6.1.4. Working with Live Search

By default, the system uses a "live search" feature to help you locate information. From the event console, you can search for information by:

- **Device** (name) - Device name searches:
  - Are case-insensitive.
  - Are tokenized on whitespace (meaning that any searches that span whitespace and do not start with a complete token will return no results).
  - If quoted, return only exact matches.
- **Component** - Component searches:
  - Are case-insensitive.
  - Are tokenized on whitespace (meaning that any searches that span whitespace and do not start with a complete token will return no results).
  - If quoted, return only exact matches.
- **Summary** - Summary searches:
  - Are case-insensitive.
  - Are tokenized on whitespace (meaning that any searches that span whitespace and do not start with a complete token will return no results).

- **Event class** - Event class searches:
  - Are case-insensitive.
  - Are tokenized on / (slash). If the search begins with a slash, and ends with a slash or asterisk, then event classes are searched by using a "starts with" approach. If a search starts with a slash and ends with any other character, then event classes are searched by using an exact match for the event class. If a search does not begin with a slash, then event classes are searched by using a sub-string match on each event class.
- **IP Address** - IP address searches (for IPv4 and IPv6 values):
  - Are tokenized by . (period) and : (colon). For example, the following searches would return a result of 129.168.1.100:
    - 168
    - 168.1
    - 129.16\*
    - \*29
  - **First Seen, Last Seen, State Change** - This field is not tokenized; date searches are converted to numeric representations, and then ranges using these representations are created. Search values are inclusive. Searches on date fields will search from the value entered. Any results that match the value or any value in the future are returned.

The following searches would return the First Seen time of 2011-05-04 15:52:52:

- First Seen: 2011-05-01 00:00:00
- First Seen: 2011-05-04 15:52:52

With live search enabled (the default behavior), the system filters available information immediately. It presents increasingly refined information with each character you type in the search window. When disabled, search responds only after you enter one or more characters and then press Enter.

To disable or enable the live search feature, select or de-select the Enable live search option from the Settings page (Advanced > Settings).

#### 7.1.6.1.5. Saving an Event Console View

You can save your event console view by bookmarking it for quick access later. To do this:

1. Select **Configure > Save this configuration**.

A dialog containing a link to the current view appears.

2. Click and drag the link to the bookmarks link on your browser's menu bar.

A link titled "Event Console" appears in your bookmarks list.

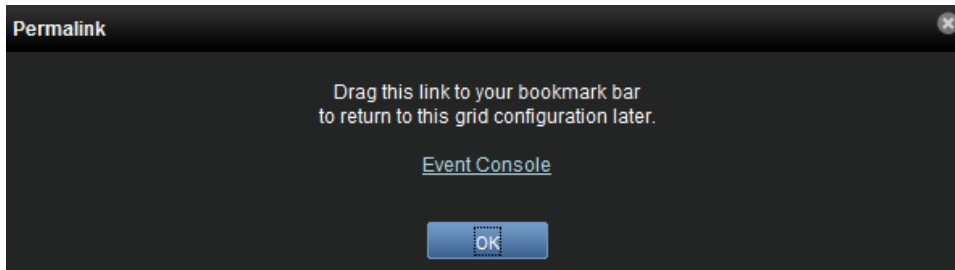
**Figure 7.6. Saving a Custom View (Bookmark)**

**Tip:** You may want to re-title the bookmark, particularly if you choose to save more than one event console view.

#### 7.1.6.1.6. Refreshing the View

You can refresh the list of events manually or specify that they refresh automatically. To manually refresh the view, click **Refresh**. You can manually refresh at any time, even if you have an automatic refresh interval specified.

To set up automatic refresh, select one of the time increments from the Refresh list.

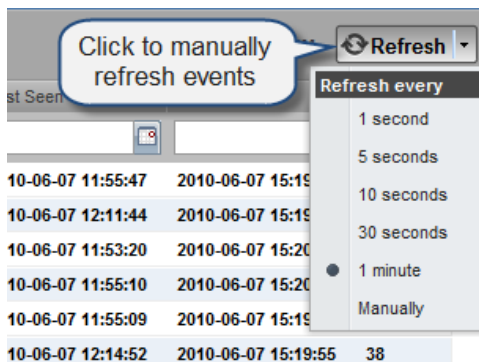
**Figure 7.7. Automatic Refresh Selections**

#### 7.1.6.1.7. Viewing Event Details

You can view details for any event in the system. To view details, double-click an event row.

The Event Details area appears.

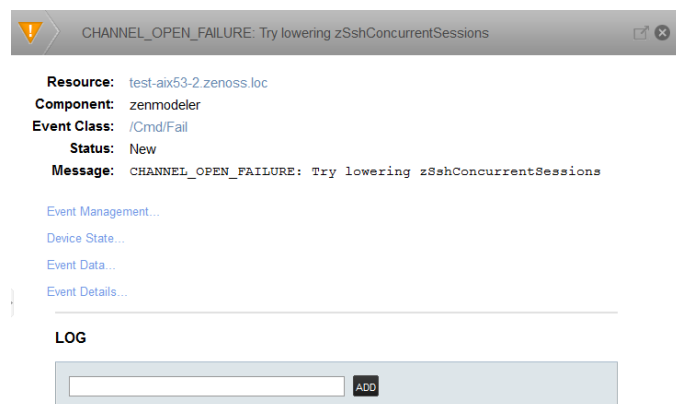
**Figure 7.8. Event Details**

To see more information about the event, click the Event Management, Device State, Event Data, or Event Details link. To display the event information in a new window, click the icon located at the top right.

You can use the Log area to add specific information about the event. Enter details, and then click **Add**.

#### 7.1.6.1.8. Acknowledging Events

You may want to mark an event as "acknowledged" to indicate, for example, that you have taken action to remedy a problem. To mark events as acknowledged:

1. Select one or more events in the event console view.

2. Click .

A check mark appears for each acknowledged event.

#### 7.1.6.1.9. Returning Events to New Status

You may want to return a previously acknowledged event to "new" status (revoke its "acknowledged" status). To do this:

1. Select one or more events in the event console view.

2. Click .

A check mark no longer appears in the event row, and the event is returned to "new" status.

#### 7.1.6.1.10. Classifying Events

Classifying events lets you associate events shown as **/Unknown** with a specific event class. To classify an unknown event, an event class key must be specified for the event.

To classify events:

1. Select one or more **/Unknown** events in the event console view.

2. Click .

The Classify Events dialog appears.

3. Select an event class from the list of options, and then click **Submit**.

## Note

You can also classify events from the event archive.

### 7.1.6.1.11. Closing Events

When you no longer want to actively monitor event (such as after you acknowledge it, for example), you can specify to close the event and move it to the event archive according to a configured event archive interval. To do this:

1. Select one or more events in the event console view.

2. Click .

The selected events are closed and moved to the archive at the specified interval.

To view events in the event archive, select Events > Event Archive.

## Note

Users with no assigned role can view all events in the archive.

### 7.1.6.1.12. Reopening Events

You can reopen events in the active event console that are in the Closed, Cleared, or Aged state. To do this:

To reopen events:

1. Select one or more Closed, Cleared, or Aged events.

2. Click .

The selected events are returned to active status.

## Note

You cannot re-open a closed event if another active event with the same fingerprint exists. Before you can re-open the closed event, you must close the new event.

### 7.1.6.1.13. Exporting Event Data

You can export data from the event console to a comma-separated value (.csv) or XML file. You can select individual events (to export only those events), or make no selections (to export all events that match the current filter criteria).

To export events:

1. Optionally select one or more events.
2. Select **Export > CSV** or **Export > XML**. By default, the exported file is named `events.Extension`.

### 7.1.6.2. Creating Events

To create events from the event console, click .

For more information about manual event creation, see the section titled "Creating Events Manually."

### 7.1.7. Event Sources

Events come into the system in two ways. *Generated events* are created as a result of active polling. *Captured events* are transmitted by external actions into the system.

#### 7.1.7.1. Generated Events

These standard daemons are responsible for generating events. They automatically perform appropriate de-duplication and auto-clearing.

- **zenping** - Ping up/down events
- **zenstatus** - TCP port up/down events
- **zenperfsnmp** - SNMP agent up/down events, threshold events
- **zencommand** - Generic status events, threshold events
- **zenprocess** - Process up/down events, threshold events
- **zenwin** - Windows service up/down events

#### 7.1.7.2. Captured Events

Captured events are those events that the system does not specifically know will occur in advance. De-duplication is performed on these events, but in some cases may need to be tuned. By default, no auto-clearing is done on captured events. Event transforms must be used to create the auto-clear correlations.

These standard daemons are responsible for collecting captured events:

- **zensyslog** - Events created from syslog messages.
- **zentrap** - Events created from SNMP traps and informs.
- **zeneventlog** - Events created from the Windows event log.

There are a number of APIs available for submitting events into the system. For more information, see the *Zenoss Developer's Guide*.

Any ZenPacks you install may optionally include their own daemons.

### 7.1.8. Creating Events Manually

You can manually create events. While this is not something you would do as part of normal system operation, it can be helpful when you are attempting to test mappings and transforms you have created.

#### 7.1.8.1. Creating Events through the User Interface

To create events manually through the user interface:

1. Navigate to Events, and then click  (Add Event).

The Create Event dialog appears.

**Figure 7.9. Create Event Dialog**

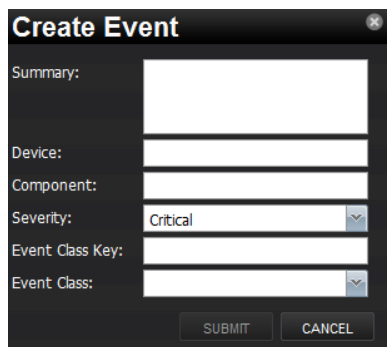

2. Complete the basic event fields. Event class mappings are applied only for events that do not already have an event class.

### 7.1.8.2. Creating Events from the Command Line

To send events from the command line, use the `zensendevent` script, in this format:

```
zensendevent Options summary
```

Common options include:

- `-d DEVICE, --device=DEVICE`
- `-i IPADDRESS, --ipAddress=IPADDRESS`
- `-y EVENTKEY, --eventkey=EVENTKEY`
- `-p COMPONENT, --component=COMPONENT`
- `-k EVENTCLASSKEY, --eventclasskey=EVENTCLASSKEY`
- `-o OPTIONALFIELD, --optional_fieldx=OPTIONALFIELD`
- `-s SEVERITY, --severity=SEVERITY`
- `-c EVENTCLASS, --eventclass=EVENTCLASS`

#### 7.1.8.2.1. Example

The following example shows how to use the `zensendevent` script to simulate a ping down event:

```
zensendevent -d router1.example.com -s Critical -c /Status/Ping "Router down"
```

### 7.1.9. Event Classes

*Event classes* are a simple organizational structure for the different types of events that the system generates and receives. This organization is useful for driving alerting and reporting. You can, for example, create a notification that



sends you an email or pages you when the availability of a Web site or page is affected by filtering on the /Status/Web event class.

Following is a subset of the default event classes. You can create additional event classes as needed.

- /Status - Used for events affecting availability.
  - /Status/Ping - Ping up/down events
  - /Status/Snmp - SNMP up/down events
  - /Status/Web - Web site or page up/down events
- /Perf - Used for performance threshold events.
  - /Perf/CPU - CPU utilization events
  - /Perf/Memory - Memory utilization or paging events
  - /Perf/Interface - Network interface utilization events
  - /Perf/Filesystem - File system usage events
- /App - Application-related events.
- /Change - Events created when the system finds changes in your environment.

### 7.1.9.1. Event Class Configuration Properties

Just as device classes and devices have configuration properties, so do event classes and event class mappings. Configuration properties are applied hierarchically, with the most specific property being applied.

The following configuration properties are available on event classes and class mappings.

- **zEventAction** - How and where affected events are stored when they occur.
  - **status** - Active events table with original event state
  - **history** - Active events table with closed event state
  - **drop** - Events are not stored
- **zEventClearClasses** - Optional list of event class names whose active events will be cleared by clear events occurring in this class.
- **zEventSeverity** - The severity of affected events is changed to this value unless the Original value is used.

A good example of how the system uses the event class configuration properties is found in the /Status event class. Within the /Status event class' configuration properties, zEventAction is set to "history" and zEventSeverity is set to "Original." This means that events sent with this event class are sent into the active events table with an initial state of closed, and the event severity unchanged.

For more information about event manipulation techniques, see the section titled "Mapping and Transformation."

### 7.1.10. Mapping and Transformation

The event mapping and transformation system allows you to perform a wide range of operations, from altering the severity of certain events to altering nearly every field on an event, based on complex rules.

You cannot alter the following fields through event transformation. (This is because they are set after transformation has been performed.)

- evid
- firstTime
- lastTime
- count

The following illustration shows the path followed by an incoming event in the event mapping system.

**Figure 7.10. Event Processing**

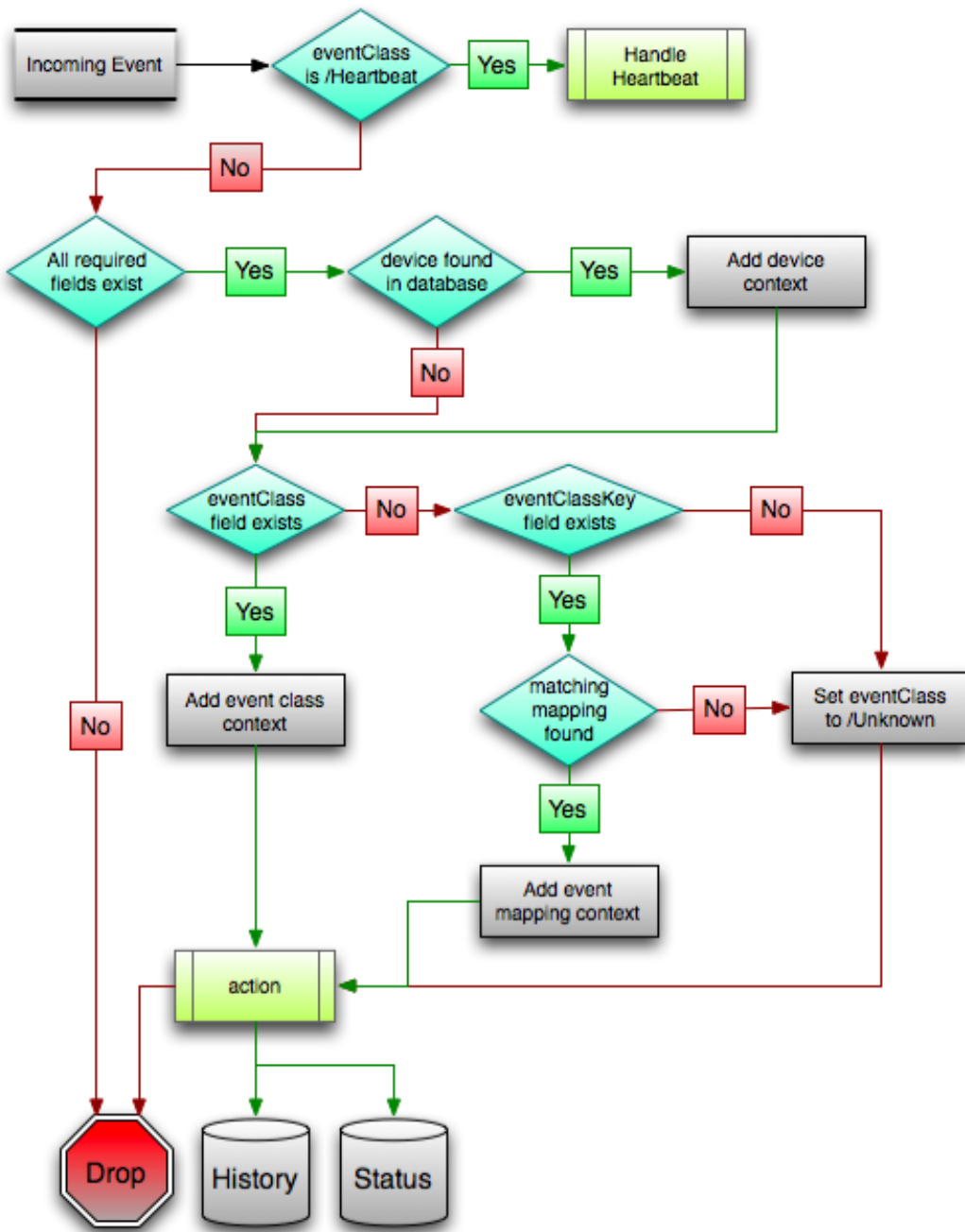

The mapping and transformation process begins with the "eventClass field exists" decision. This also is one of the more important differentiators in how you must handle a particular type of event.

### 7.1.10.1. Event Class Mappings

To view event class mappings, select Events > Event Classes, and then select Mappings in the left panel. This allows you to see all event class mappings in a single location. The EventClass column shows the mapping's event class.

You can create event class mappings directly from the event classes, but this requires that you know the event class key. A simpler way to create event class mappings is through the event console:

1. Select an event that you want to match in the event console.

2. Click  (Map to event class).

The Classify Events dialog appears.

3. Select the event class to which you want to map the event, and then click **Submit**.

This creates the event class mapping with the correct event class key, and example text against which you can develop your regular expression.

When editing an event class mapping, you can control which events it will match, as well as other properties:

- **Event Class Key** - Must match the incoming event's Event Class Key field for this mapping to be considered as a match for events.
- **Sequence** - Sequence number of this mapping. This number determines the order in which mappings with the same event class key are evaluated.
- **Rule** - Provides a programmatic secondary match requirement. It takes a Python expression. If the expression evaluates to True for an event, this mapping is applied.
- **Regex** - The regular expression match is used only in cases where the rule property is blank. It takes a Perl Compatible Regular Expression (PCRE). If the regex matches an event's message field, then this mapping is applied.
- **Transform** - Takes Python code that will be executed on the event only if it matches this mapping. For more details on transforms, see the section titled "Event Class Transform."
- **Explanation** - Free-form text field that can be used to add an explanation field to any event that matches this mapping.
- **Resolution** - Free-form text field that can be used to add a resolution field to any event that matches this mapping.

Mappings have the same configuration properties as event classes. Any configuration property set locally on a mapping will override the same property set on the event class. This works in the same hierarchical, most specific match, concept that device class and device configuration properties work.

When a captured event occurs, it will not have a pre-defined event class. For this type of event, you must create an event class mapping if you want to affect the event. If a captured event occurs and none of the event class mappings in the system match it, its event class will be set to /Unknown, and it will retain all of the default properties with which it began.

The next step of evaluation for events without an event class is to check the Event Class Key field. This controls which event class mapping the event will match. If the event has a blank event class key, or its event class key does not match

any event class mappings in the system, the special “defaultmapping” event class key is searched for instead. This provides for a way to map events even if they have a blank or unpredictable event class key.

### 7.1.10.2. Event Class Mapping Sequence

The sequence area of an event class mapping (select Sequence in the left panel) allows you to provide more than one mapping for the same event class key. In this case, the sequence is evaluated in ascending order until a full (rule or regex) match is found.

For example, suppose a router is sending in unclassified events that need to be mapped to two event classes:

- /Events/Router/fanDown
- /Events/Router/fanUnknown

The event class key for both has been sent to "router", but one has a message of "Fan Down" and the other has no message at all. The mapping on /Events/Router/fanDown has an event class key of "router" and a regex of "Fan Down." The mapping on /Events/Router/fanUnknown has only an event class key of "router" and (in this example) no regex. Because the fanUnknown mapping matches the fanDown events, the evaluation of fanDown needs to occur first.

You can modify the evaluation of mappings with the same event class key in the Sequence area of any of those event class mappings. In the previous example, you could go to either mapping, select Sequence, and both mappings would be displayed. You can set one to 0, and the other to 1. (You can enter other values, but they will be changed to the shortest list of integers, starting with 0.) Setting fanDown to 0 and fanUnknown to 1 will ensure that the events will be mapped properly.

### 7.1.10.3. Event Class Transform

When a generated event occurs, it has an event class assigned to it. This causes the event class mapping step to be skipped. The only way to affect the fields of one of these events is through the event class' configuration properties and transform.

To access the transform for an event class:

1. Navigate to the event class from Events > Event Classes.
2. From the Action menu, select Transform.
3. Enter information into the dialog (as Python code), and then click **Save**.

The objects available in this Python context are `evt` (the event); and, if the event matches a device that exists in the system database, a `device` object.

#### Example

The following example shows how you can validate that a device object exists before using it to drop events from a particular location.

```
if device and "Hawaii" in device.getLocationName():
    evt._action = "drop"
```

### 7.1.11. Event Life Cycle

In addition to manual methods for getting events into the status table or event archive, there are automated processes that move events from status into the archive. The *event life cycle* is defined as all of the ways that events can be added to, moved in, and deleted from the database.

The following illustration depicts the event life cycle.

**Figure 7.11. Event Life Cycle**

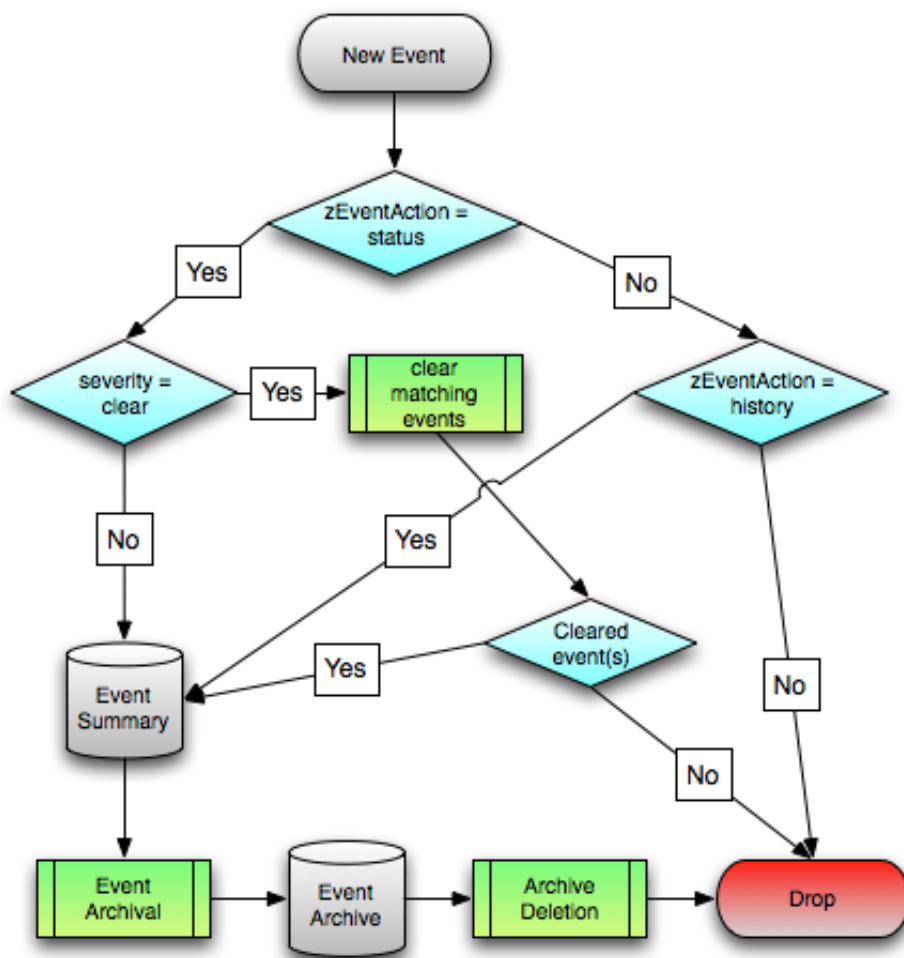

### 7.1.11.1. Automatic Event Aging

From the Event Configuration page (Advanced > Settings > Events), you can set up automatic aging of events. Aging of events will automatically update active events that match the severity and aging threshold to a status of Aged. After the configured event archive interval, all Closed, Aged, and Cleared events are moved to the event archive.

Properties that control this behavior are:

- **Event Aging Threshold (hours)** - By default, set to 4 hours.
- **Don't Age This Severity and Above** - By default, set to Error.

### 7.1.11.2. Automatic Archived Event Cleanup

You can set up automatic purging of events from the event archive from the Event Configuration page (Advanced > Settings > Events). When events are purged, they can be recovered only from backups.

The property that controls this behavior is Delete Archived Events Older Than (days). Acceptable values are between 1 and 1000 (days).

## 7.1.12. Capturing Email Messages as Events

ZenMail and ZenPop allow you to capture email messages as events. This capability can be useful for situations in which embedded systems (such as WAPs, NAS devices, or RAID controllers) rely on email notification for events.

### 7.1.12.1. ZenMail

ZenMail serves as an SMTP server that you can bind to a specific TCP port. You can then configure your embedded system to send mail to the Zenoss Core server explicitly by using the server's IP address as the relay.

ZenMail supports these configuration directives:

- `${ZENHOME}/bin/zenmail` (no arguments) - Default operation. Binds to port 25 on all ports and listens for email messages to arrive. Ignores the TO field in the email and uses the FROM address as the device IP address.
- `${ZENHOME}/bin/zenmail --listenPort` - Bind to the port provided. Useful in situations in which an SMTP server is already running on the Zenoss Core server and you do not want to interfere with the existing mail delivery system. Semantics are the same as the no argument version (FROM address is used as the device IP).

### 7.1.12.2. ZenPop

ZenPop allows you to retrieve event email from a POP server. ZenPop supports these configuration directives:

- `--usessl` - Issue the STARTTLS command to the POP server and attempt to transfer email messages using SSL encryption. This is required if retrieving mail from Google.
- `--nodelete` - Do not issue the DELE command after retrieving all messages. Typically this is used during initial testing so that you do not have to resend test messages to the POP account. Some email systems (such as Google) do not actually delete messages when the DELE command is issued.
- `--pophost` - The hostname or IP address of the POP server from which to retrieve messages.
- `--popport` - The TCP port the POP server listens on. Defaults to 110. Used in situations where the POP provider listens on another port (for example, Google on port 995).
- `--popuser` - The user name that contains email messages to retrieve.
- `--poppass` - The password to use for the user name provided.
- `--cycletime` - The time to sleep between polls. After all email is retrieved, ZenPop sleeps for this amount of time before waking up and attempting to pull new email.

### 7.1.12.3. Translating Message Elements to the Event

Zenoss Core translates various message elements to the event, as follows:

- **FROM Field** - If the FROM field is an IP address, then the system associates the event with the device with the same IP address. If the FROM field is a fully qualified domain name, then the system resolves it to an IP address, and then performs the device association using the resolved IP address. The resolution of hostname uses "A" records rather than "MX" records.
- **TO Field** - The system ignores the TO field in the email message. ZenMail accepts email to any user and domain name combination. ZenPop also drops the TO field, and uses only the FROM field.
- **SUBJECT Field** - ZenMail and ZenPop use the SUBJECT as the event summary.

- **Message Body** - ZenMail and ZenPop use the first mime attachment as the event details. The system ignores secondary message bodies (typically HTML-encoded versions of the message). It also ignores attachments (such as files).

## 7.1.13. SNMP Traps and Event Transforms

An SNMP trap is a message that is initiated by a network element and sent to the network management system. Often, traps indicate a failure of some sort, such as a router message indicating a power supply failure, or a printer message indicating an "out-of-ink" condition.

If an SNMP trap enters the system, and Zenoss Core cannot identify the event (the event is classified as "/Unknown"), then you can classify the event so that the system handles it consistently.

### 7.1.13.1. Classifying SNMP Traps

To classify an SNMP trap event:

1. From the Event Console, select the unknown event or events.

2. Click  (Map to event class).

The Classify Events dialog appears.

3. Select /App, and then click **Submit**.

To edit this classification:

1. From the Navigation area, select Events > Event Classes.
2. In the left panel, select Mappings.
3. Select the event map you created.
4. In the left panel, select Edit.

The edit page appears. This page contains rules used to map the event to the /App category. This rule, since it matches the trap by a specific OID, is all that is needed.

In the Transform area, you can enter code to modify the summary. For example, if you want to set the summary string to "Spam Filter Detects Virus," then you can enter:

```
evt.summary = "Spam Filter Detects Virus"
```

A trap has a header with some standard information, followed by a sequence of attribute/values.

You have indicated you want the value for the OID ".1.3.6.1.4.1.9789.1500.2.5" as the summary. If you had the MIB loaded, you could do this:

```
evt.summary = evt.spamFilterDetectsVirus
```

However, the OID and the data is still in there. Instead, use the slightly more cryptic:

```
evt.summary = getattr(evt, ".1.3.6.1.4.1.9789.1500.2.5", "Unexpected missing OID")
```

The "device" object for the event has been made available, as well:

```
evt.summary = getattr(evt, ".1.3.6.1.4.1.9789.1500.2.5", "Unexpected missing OID") \
```

```
+ " from device " + device.getId()
```

Zenoss Core uses MIBs to translate SNMP traps that contain raw OID values. Loading an MIB into the system allows it to translate numeric OIDs such as .1.3.6.1.2.1.1.6 into descriptive phrases like “sysLocation”. It also makes it easier to manipulate the events in an event mapping.

**Figure 7.12. SNMP TRAP Transform**

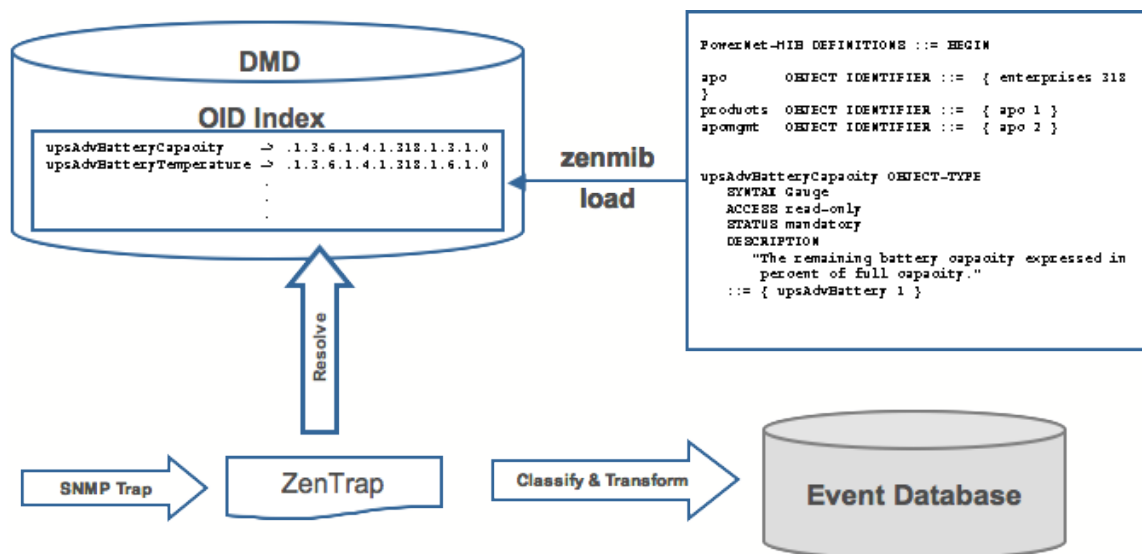

Following is a small demonstration MIB.

```
NOTIFICATION-TEST-MIB DEFINITIONS ::= BEGIN
IMPORTS
ucdavis FROM UCD-SNMP-MIB
NOTIFICATION-TYPE FROM SNMPv2-SMI
;
demonotifs OBJECT IDENTIFIER ::= { ucdavis 991 }
demo-notif NOTIFICATION-TYPE
OBJECTS { sysLocation }
STATUS current
DESCRIPTION "Just a test notification"
 ::= { demonotifs 17 }
END
```

### 7.1.13.2. Example: Sending Test Traps

Follow these steps to send an SNMP trap.

1. From the command line, enter the following command:

```
$ snmptrap -v 2c -c public localhost '' 1.3.6.1.4.1.2021.991.1.3.6.1.2.1.1.6 s \
"Device in Annapolis"
```

2. Save this demonstration MIB into a file.
3. Send the trap.
4. Open the Event Console and find the trap you sent.
5. In the far right column of the event console, click the magnifying glass in the far right column for the event you just sent.



6. Click the Details tab.

You should see:

```
.1.3.6.1.2.1.1.6 Device in Annapolis
```

7. Send this event to the event archive.

Now, load some MIBs into the system so that this OID is translated into a better format:

1. Copy the demonstration MIB into `$ZENHOME/share/mibs/site`.

2. Run **zenmib** to load it:

```
$ zenmib run -v 10 DEBUG:zen.zenmib:TRAP-TEST-MIB.mib INFO:zen.zenmib:Unable to find a file \
providing the MIB UCD-SNMP- MIB ...
```

3. The MIB loaded, but is missing some other definitions. Copy them:

```
$ cp /usr/share/snmp/mibs/SNMPv2-MIB.txt $ZENHOME/share/mibs/site \
$ cp /usr/share/snmp/mibs/UCD-SNMP-MIB.txt $ZENHOME/share/mibs/site
```

4. Run **zenmib** again and load the definitions into the system:

```
$ zenmib run -v 10
```

5. Restart the **zentrap** daemon to retrieve the new MIB information:

```
$ zentrap restart
```

6. Send the trap a second time:

```
$ snmptrap -v 2c -c public localhost '' 1.3.6.1.4.1.2021.13.991 .1.3.6.1.2.1.1.6 s \
"Device in Annapolis"
```

7. Check the event. Make sure the count is 1. If the count is 2, send the event to the event archive and send the trap again. Look at the Details tab. Now you should see something like this:

```
sysLocation Device in Annapolis
```

You should also see that the event summary changes from:

```
snmp trap 1.3.6.1.4.1.2021.13.991 from localhost
```

to:

```
snmp trap ucdExperimental from localhost
```

### 7.1.13.3. Transforming Events with Event Mappings

To modify events as they arrive, create an event map through the user interface:

1. Create an event class.
2. Go to the event console and create an event mapping in this class from the existing event.
3. Edit the map.
4. In the Transform area, update the event with detail data. The entry field allows you to insert Python scripts. The event is provided as "evt" and the device as "dev."

In this case, extract the sysLocation event detail and make it the summary with:

```
evt.summary = evt.sysLocation
```

5. Save the event mapping.

If you move the event to the event archive and resend the trap, the summary for the trap should now read the device name in the location you assigned.

If you encounter problems with the transform, check the `zentrap.log` file for errors that occurred.

#### 7.1.13.4. Event Transforms Based on Event Class

When an event arrives in the system, you can change values (such as severity). For example, you can make the summary more informative, or change severity according to text within the summary.

Each event class allows for a short Python script to be executed when an event arrives.

##### Example

A user may want full file system threshold events on `/data` to be critical. Add the following Python script in the Threshold Transform of `/Events/Perf/Filesystem`:

```
if evt.component == '/data' and evt.severity != 0:  
    evt.severity = 5
```

Like event mappings for event class keys, "evt" and ""dev" objects are available in the script of the transform.

---

# Chapter 8. Production States and Maintenance Windows

## 8.1. About Production States and Maintenance Windows

*Production state* determines the level of monitoring and alerting applied to an individual device. Typically, notifications specify that the system will monitor and create events for devices that are in the "Production" production state. *Maintenance windows* are planned time periods used to temporarily modify notifications so that event-generated alerts are temporarily halted.

Read this chapter for more information about defining:

- Production states
- Maintenance windows

## 8.2. Production States

Production state determines whether a device is monitored, and can be used to control several elements of the event system, such as whether an event will produce a remote alert (email or page).

Choose a production state for a device based on whether you want:

- The device to be monitored
- The device to appear on the dashboard
- Alerting to occur

The following table lists production states and their characteristics.

Production State	Devices Monitored?	Appear on Dashboard?
Production	yes	yes
Pre-Production	yes	no
Test	yes	no
Maintenance	yes	may appear
Decommissioned	no	no

Typically, devices begin in the system in "Pre-Production." In this state, devices are monitored by default, but no remote alerting occurs, and events are not shown on the dashboard. Once a device is in full "Production" state, monitoring occurs and remote alerts are sent. If service needs to be performed on a device, its state can be set to "Maintenance" to temporarily block any remote alerts.

When you add a device to the system, its default state is Production.

### 8.2.1. Setting the Production State for Devices

To set the production state for a device:

1. Click a device name in the list of devices.

The device Overview page appears.

2. Select a production state from the list of options, and then click **Save**.

To set the production state for a group of devices:

1. Select a category of devices (by class, group, system, or location) from the hierarchy.
2. From the list of options in the Production State column, select a production state.

The newly selected state is applied to all devices that appear in the list.

**Figure 8.1. Select Production State (Multiple Devices)**

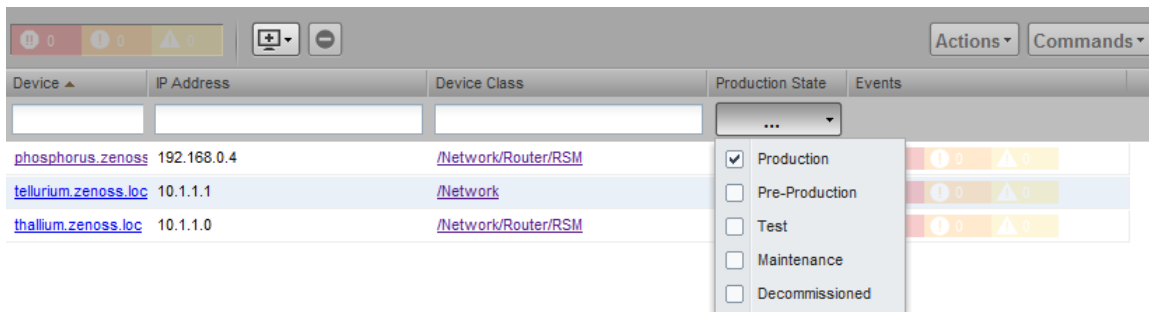

## 8.3. Maintenance Windows

Maintenance windows allow scheduled production state changes of a device or all devices in a system, group, or location. You might want to set up a maintenance window, for example, to prevent alerts and warnings while you perform configuration changes or reboot a device.

### Note

In lieu of setting up a maintenance window, you can change the production state for a device manually at the time you want to make changes.

When the maintenance window starts, the production state of the device is set to the value of Start Production State (Maintenance). When the maintenance window closes, the production state of the device reverts to the value of Stop Production State (the state the device was in prior to maintenance).

### 8.3.1. Maintenance Window Events

When a maintenance window starts, an event is created with the following information:

- deppuid - zenactions | *Monitor* | *MaintenanceWindowName* | *TargetOrganizerOrDevice*
- prodState - *StartProductionState*
- severity - Info
- summary/message - Maintenance window starting *MaintenanceWindow* for *Target*
- eventClass - /Status/Update

- eventClassKey - mw\_change
- maintenance\_devices - *Target*
- maintenance\_window - *MaintenanceWindow*

When a maintenance window stops, an event is created with the following information:

- severity - Clear
- summary/message - Maintenance window stopping *MaintenanceWindow* for *Target*
- prodState - -99 (meaning "unknown.")

Maintenance window events auto-clear, meaning that stop events clear start events.

## 8.3.2. Creating and Using Maintenance Windows

You can create a maintenance window for an individual device or group of devices in the devices hierarchy.

### 8.3.2.1. Create a Maintenance Window for a Single Device

To create a maintenance window for a device:

1. Click a device name in the devices list.

The device Overview page appears.

2. In the left panel, select Administration.

3. In the Maintenance Windows area, select Add Maint Window from  (Action menu).

The Add Maintenance Window dialog appears.

4. Enter a name for the maintenance window, and then click **OK**.

The newly defined maintenance window appears in the list.

5. Click the name in the list to show the maintenance window status page.

6. Define the attributes for the maintenance window:

- **Name** - Name of the maintenance window.
- **Enabled** - Select True to make the maintenance window active, or False to de-activate it.
- **Start** - Specify a date and time for the window to become active.
- **Duration** - Specify the length of time for the window to be in effect.
- **Start Production State** - Define the production state for the window when the maintenance period begins.
- **Stop Production State** - Shows the production state that will be in effect when the maintenance period ends.

7. Click **Save**.

### 8.3.2.2. Create a Maintenance Window for a Group of Devices

To create a maintenance window for a group of devices:

1. Select a group of devices from the devices hierarchy or devices list.
2. Click **Details**.
3. In the left panel, select Administration
4. In the Maintenance Windows area, select Add Maint Window from  (Action menu).

The Add Maintenance Window dialog appears.

5. Enter a name for the maintenance window, and then click **OK**.
6. Click the name in the list to show the maintenance window status page.
7. Define the attributes for the maintenance window:

- **Name** - Name of the maintenance window.
- **Enabled** - Select True to make the maintenance window active, or False to de-activate it.
- **Start** - Specify a date and time for the window to become active.
- **Duration** - Specify the length of time for the window to be in effect.
- **Start Production State** - Define the production state for the window when the maintenance period begins.
- **Stop Production State** - Shows the production state that will be in effect when the maintenance period ends.

8. Click **Save**.

---

# Chapter 9. Organizers and Path Navigation

## 9.1. About Organizers and Path Navigation

You can group system objects, including devices, sub-systems, configuration properties, and templates. A device, for example, can belong to multiple classifications, including:

- Groups
- Systems
- Locations
- Device classes

In the following illustration, the device `tilde.zenoss.loc` belongs to five different classifications. Configuration properties and monitoring settings for each of these groups are applied to this device.

**Figure 9.1. Device Groupings**

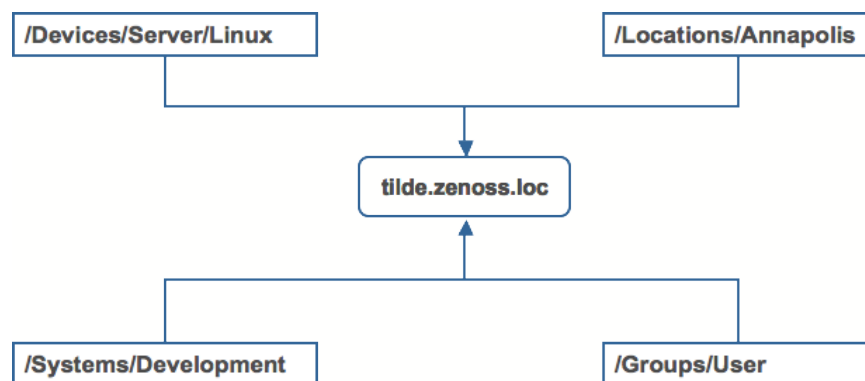

Read the following sections to learn more about how organizers classify devices in the system.

## 9.2. Classes

The most important organizers are *classes*, which comprise:

- Device classes
- Event classes
- Service classes
- Product classes

Templates and configuration properties can be inherited based on class. These attributes can be overwritten further down the class hierarchy, all the way down to the individual component level. The class hierarchy includes all defined and standard classes and sub-classes.

The following procedures are illustrated using device classes and sub-classes, but the same concepts apply to event classes, service classes, and product classes. When you add a device to the system, you should (after providing the

network name or IP address) specify its device class. Templates and configuration properties can be set at any level in the device class hierarchy.

## 9.2.1. Viewing Device Classes

To view device classes and the devices they contain, select Infrastructure from the Navigation menu.

The device list appears. The top of the devices hierarchy lists device classes. Click a class name to view devices in that class, or expand it to show sub-classes.

**Figure 9.2. Devices Hierarchy**

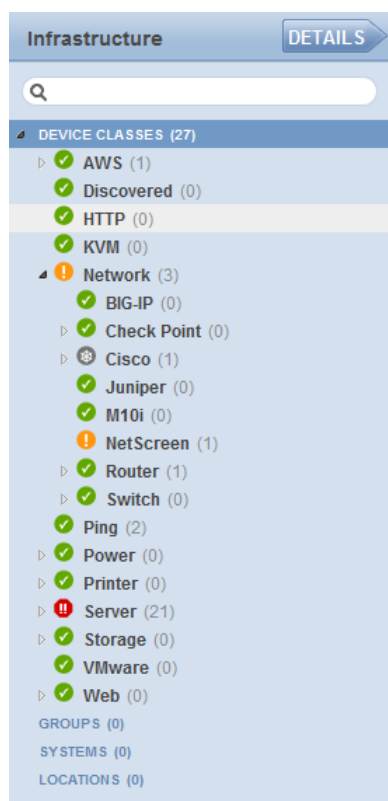

An indicator appears next to each listed class to show whether there are events associated with any devices in that class.

## 9.2.2. Adding Classes

To create a device class:

1. Select Infrastructure from the Navigation menu.

The device list appears.

2. Select the location in the device class hierarchy where you want to add a new class.

3. Click  (Add).

The Add Device Class dialog appears.



4. Enter a name and description for the new device class, and then click Submit.

The new device class appears in the hierarchy. You can now move devices into this class. Select one or more devices in the device list, and then drag them to the new class.

### 9.2.2.1. Moving a Class

To move a class in the hierarchy:

1. Select the class in the hierarchy.
2. Drag the class to its new location.

The Move Organizer confirmation dialog appears.

3. Click **OK** to confirm the action.

The class appears at its new location in the hierarchy.

### 9.2.3. Setting Configuration Properties at the Class Level

To set configuration properties at the device class level:

1. Select a device class in the devices hierarchy.
2. Click Details, and then click Configuration Properties.

The Configuration Properties page for the selected device class appears.

**Figure 9.3. Device Class Configuration Properties**

zProperties Configuration			
Property	Value	Type	Path
zCollectorClientTimeout	180	int	/
zCollectorDecoding	latin-1	string	/
zCollectorLogChanges	True	boolean	/
zCollectorPlugins	Edit	lines	/Discovered
zCommandCommandTimeout	15.0	float	/
zCommandCycleTime	60	int	/
zCommandExistenceTest	test -f %s	string	/
zCommandLoginTimeout	10.0	float	/
zCommandLoginTries	1	int	/
zCommandPassword		password	/
zCommandPath	/usr/local/zenoss/libexec	string	/
zCommandPort	22	int	/
zCommandProtocol	ssh	string	/
zCommandSearchPath		lines	/
zCommandUsername		string	/
zDeviceTemplates	Device	lines	/

3. Edit configuration properties definitions as desired, and then click **Save**.

Definitions are applied to all devices currently in, and added to, this class (unless overridden at a lower level in the hierarchy).

## 9.3. Systems

Systems are intended to follow virtual setups, such as those in a network setup or systems grouped by functionality.

### 9.3.1. Adding Systems

To add a system or sub-system:

1. Select Infrastructure from the Navigation menu.

The device list appears.

2. Select the location in the systems hierarchy where you want to create a system.

3. Click  (Add).

The Add System dialog appears.

**Figure 9.4. Add System**

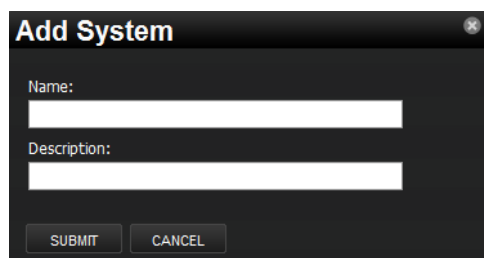

4. Enter a name and description for the system, and then click **Submit**.

The system appears in the hierarchy. You can now move devices to this system. Select one or more devices in the device list, and then drag them to the new system.

#### 9.3.1.1. Moving a System

To move a system:

1. Select the system in the hierarchy.
2. Drag the system to its new location.

The Move Organizer confirmation dialog appears.

3. Click **OK** to confirm the action.

The system appears at its new location in the hierarchy.

## 9.4. Groups

Groups are functional divisions that allow you to assign attributes to multiple objects with similar functions. Groups can be used, for example, to arrange objects along departmental lines. Groups do not appear on the Dashboard.

## 9.4.1. Adding Groups

To add a group:

1. Select Infrastructure from the Navigation menu.

The device list appears.

2. Select the location in the groups hierarchy where you want to create a group.

3. Click  (Add).

The Add Group dialog appears.

4. Enter a name and description for the group, and then click **Submit**.

The group appears in the hierarchy. You can now move devices to this group. Select one or more devices in the device list, and then drag them to the new group.

### 9.4.1.1. Moving a Group

To move a group:

1. Select the group in the hierarchy.
2. Drag the group to its new location.

The Move Organizer confirmation dialog appears.

3. Click **OK** to confirm the action.

The group appears at its new location in the hierarchy.

## 9.5. Locations

Locations are logical groupings for physical systems. They can be as general as city and state, or as specific as rack or closet. Locations do not appear on the Dashboard.

### 9.5.1. Adding Locations

To add a location:

1. Select Infrastructure from the Navigation menu.

The device list appears.

2. Select the place in the Locations hierarchy where you want to create a location.

3. Click  (Add).

The Add Location dialog appears.

4. Enter a name and description for the location, and then click **Submit**.

The location appears in the hierarchy. You can now move devices to this location. Select one or more devices in the device list, and then drag them to the new location.

### 9.5.1.1. Moving a Location

To move a location:

1. Select the location in the hierarchy.
2. Drag the location to its new place.

The Move Organizer confirmation dialog appears.

3. Click **OK** to confirm the action.

### 9.5.2. Integration with Google Maps

The system can map locations by using a Google Maps mashup feature that sets the location's Address property to a valid Google Maps address. The selected location appears on the map as a dot. The color of the dot represents the highest severity of any event on any device in that location.

Network connections that span locations are represented on the map by lines. Each line color matches the status of the connection it represents.

**Figure 9.5. Network Location - Google Map**

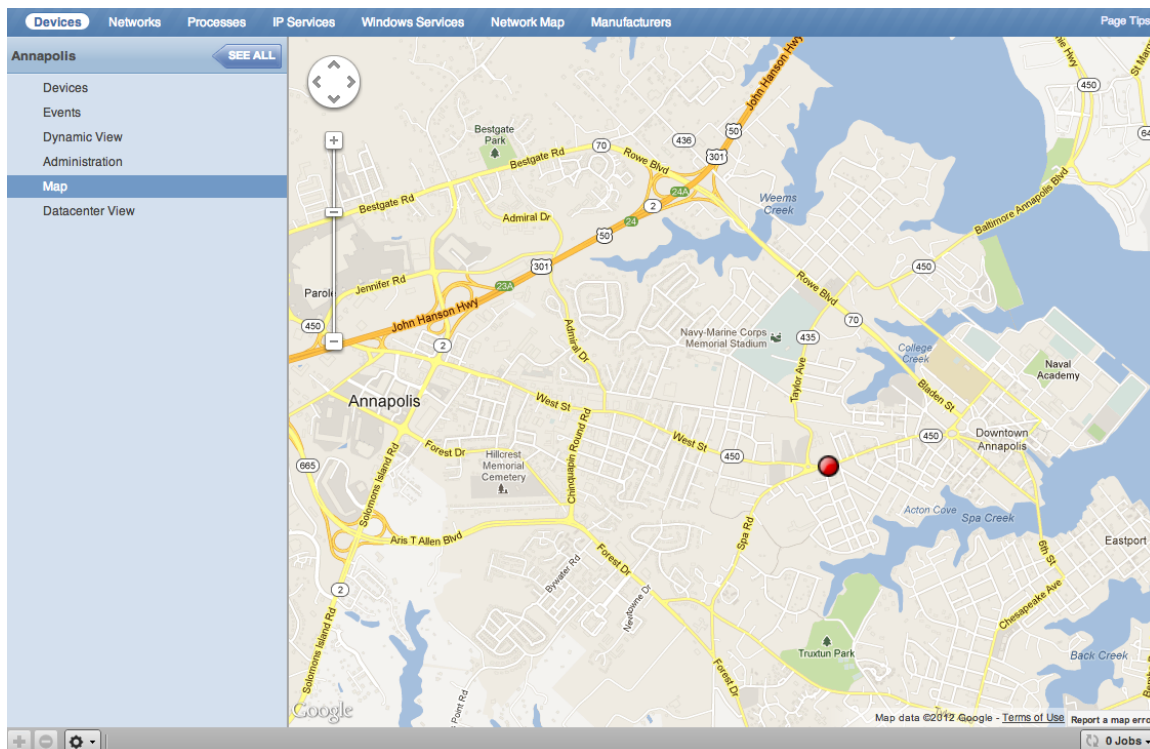

To view the Google Map for a network location:

1. From the Navigation menu, select Infrastructure.

The device list appears.

2. In the hierarchy, select a location.
3. Click **Details**.
4. Select Map.

The network map appears.

## Note

You also can view the network location map from the Locations portlet on the dashboard.

### 9.5.2.1. Obtaining an API Key

Before you can use the Google Maps feature, you must obtain or register for a Google Maps API key. To obtain this key:

1. Browse to the following location:

<https://code.google.com/apis/console>

## Note

This link is also available from the Google Maps API Key field help, from Advanced > Settings.

**Figure 9.6. Google Maps API - Help**

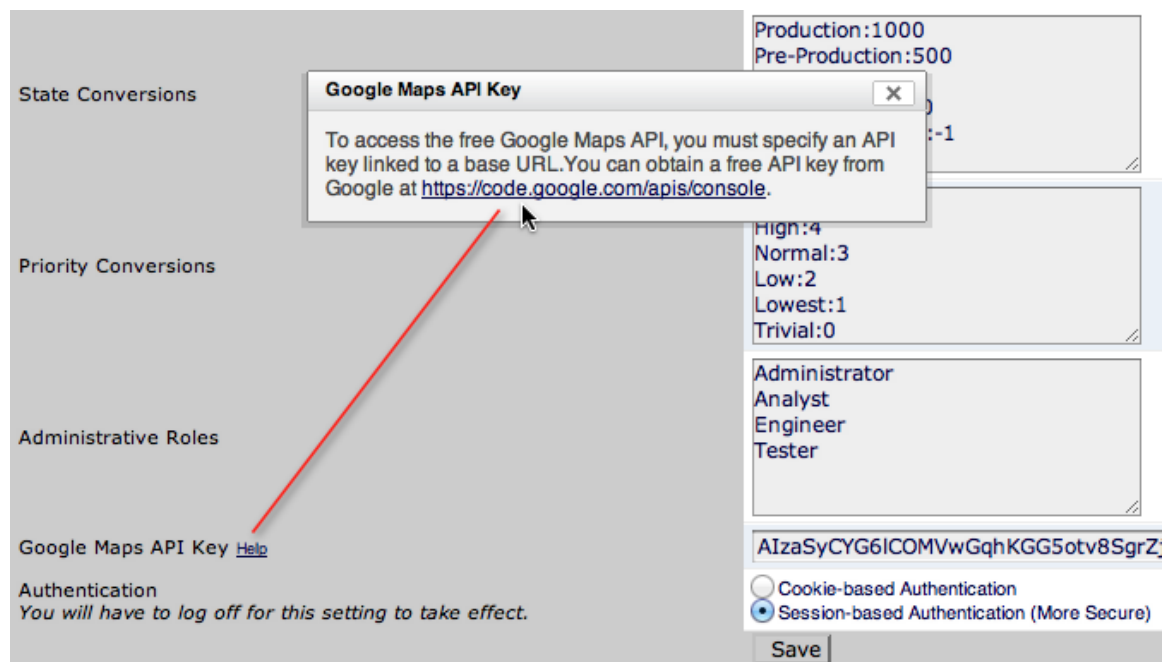























A Google APIs console dialog appears.

2. Click **Create Project**.

The projects list appears.

**Figure 9.7. Google API Projects List**

 Freebase API		<input type="checkbox"/> OFF	Courtesy limit: 100,000 queries/day
 Google Affiliate Network API		<input type="checkbox"/> OFF	Courtesy limit: 1,000 queries/day
 Google Cloud SQL		<a href="#">Request access...</a>	
 Google Cloud Storage		<input type="checkbox"/> OFF	<a href="#">Pricing</a>
 Google Maps API v2		<input type="checkbox"/> OFF	<a href="#">Pricing</a> • Courtesy limit: 25,000 queries/day
 Google Maps API v3		<input type="checkbox"/> OFF	<a href="#">Pricing</a> • Courtesy limit: 25,000 queries/day
 Google+ API		<input type="checkbox"/> OFF	Courtesy limit: 10,000 queries/day
 Google+ Hangouts API		<input type="checkbox"/> OFF	
 Groups Settings API		<a href="#">Request access...</a>	Courtesy limit: 100,000 queries/day
 Identity Toolkit API		<input type="checkbox"/> OFF	Courtesy limit: 1,000,000 queries/day
 Latitude API		<input type="checkbox"/> OFF	Courtesy limit: 1,000,000 queries/day

3. Click to toggle ON the Google Maps API V3 project
4. Agree to the displayed Terms of Service.
5. From the newly created project, select API Access.

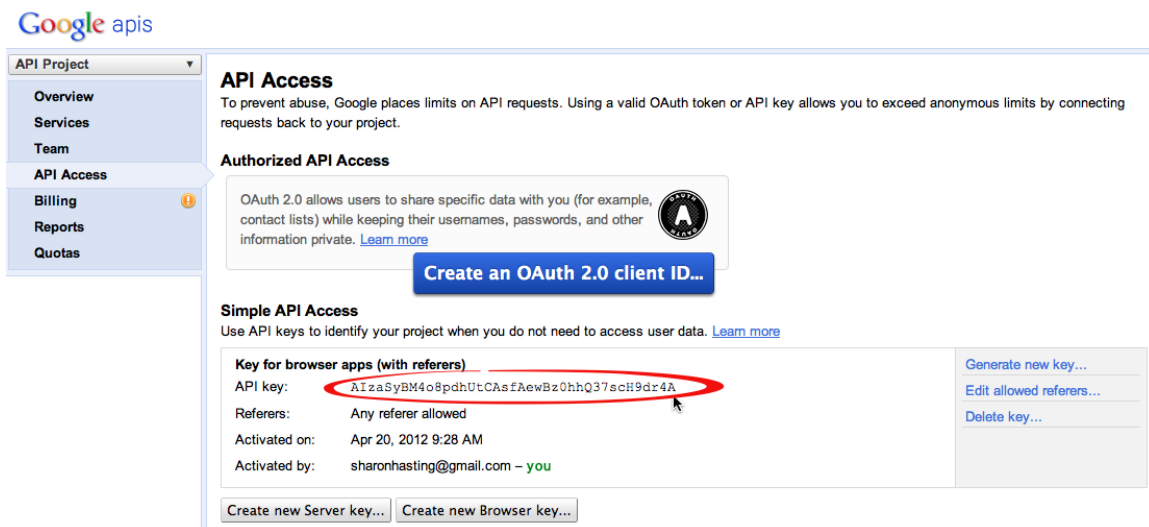
**Figure 9.8. API Access**

**Google apis**

API Project

- Overview
- Services
- Team
- API Access
- Billing
- Reports
- Quotas

### API Access

To prevent abuse, Google places limits on API requests. Using a valid OAuth token or API key allows you to exceed anonymous limits by connecting requests back to your project.

#### Authorized API Access

OAuth 2.0 allows users to share specific data with you (for example, contact lists) while keeping their usernames, passwords, and other information private. [Learn more](#)

[Create an OAuth 2.0 client ID...](#)

#### Simple API Access

Use API keys to identify your project when you do not need to access user data. [Learn more](#)

<p><b>Key for browser apps (with referers)</b></p> <p>API key: <u>AIzaSyBM4o8pdhUtCAsfAewBz0hhQ37sci9dr4A</u></p> <p>Referers: Any referer allowed</p> <p>Activated on: Apr 20, 2012 9:28 AM</p> <p>Activated by: sharonhasting@gmail.com - you</p>	<p><a href="#">Generate new key...</a></p> <p><a href="#">Edit allowed referers...</a></p> <p><a href="#">Delete key...</a></p>
---	---

[Create new Server key...](#) [Create new Browser key...](#)

6. Copy the string that appears in the API Key field.
7. Return to the Zenoss Core Interface, and then browse to Advanced > Settings.

8. Paste the copied API Key string into the Google Maps API Key field, and then click **Save**.

When you go to the Dashboard, the Google Maps area initializes and displays default map data.

### 9.5.2.2. Setting an Address for a Location

Follow these steps to set a location address:

1. Select Infrastructure from the Navigation menu.

The device list appears.

2. Select a location in the hierarchy.

3. Select Edit from  (Action menu).

The Edit Organizer dialog appears.

4. In the Description field, enter a description for the location.

5. In the Address field, enter a complete address that can be resolved by Google Maps. This address must include a valid zip code. (To test your address in advance, enter it at <http://maps.google.com>.)

6. Click **Submit**.

The selected address for the location is created. You must add at least one device to the location for the location "dot" to appear on the map.

### 9.5.2.3. Clearing the Google Maps Cache

Sometimes there are issues with drawing the maps and seeing the network status of locations or connections. Clearing the Geocode cache will solve these problems. To clear the Geocode cache:

1. Select Infrastructure from the Navigation menu.

The device list appears.

2. Select a location in the hierarchy.

3. Select Clear Geocode Cache from  (Action menu).

A confirmation dialog appears.

4. Click **OK**.

### 9.5.2.4. Network Links

If two devices in the same network are in different map-able locations, a line will be drawn on the map representing a network connection between the two. If there are multiple separate network connections between the same two locations, only one line will be drawn. The color of the line will represent the highest severity of any events affecting the connection. These are determined by:

- A ping down event on the device at either end of the connection; or
- Any event on the interface at either end of the connection.

#### 9.5.2.4.1. Drawing Map Links (zDrawMapLinks Configuration Property)

Calculating network links on the fly is an expensive procedure. If you have a large number of devices that have been assigned locations, drawing those links on the map may take a long time. To save time, you can tell the system not to attempt to draw links for specific networks (for example, a local network comprising many devices that you know does not span multiple locations).

To edit the value for this property:

1. Select Infrastructure > Networks from the Navigation menu.

The Networks page appears.

2. Select a network or sub-network for which you want to disable map links.
3. Display configuration properties for the network.
4. Double-click the zDrawMapLinks configuration property in the list.

The Edit Config Property dialog appears.

5. De-select the value (uncheck the box), and then click **Submit**.

### Note

This setting will be inherited by networks or sub-networks below this selection in the hierarchy. If you have few networks for which links would be drawn, you might want to disable map links on /Networks, enabling it only on a network where you know a location-spanning WAN connection exists.

#### 9.5.2.5. Google Maps Example

This example will show you how to:

- Create and display Google map links of devices
  - Send a test event to see how the links are affected by system changes
1. Disable map links. (Refer to the procedure in Drawing Map Links for instructions.)
  2. Create two locations: "New York" and "Los Angeles." (Refer to the procedure in Adding Locations for instructions.)
  3. Enter the following values in the Address field of the Add Location dialog: "New York, NY" and "Los Angeles, CA" respectively.
  4. Set the location of a device to New York. Locate another device on the same network and set its location to Los Angeles.
  5. Select Locations in the hierarchy, click **Details**, and then select Map.  
  
New York and Los Angeles are represented by dots on the map; however, no link is drawn between these locations.
  6. Select Networks and re-enable map linking.
  7. Select Infrastructure, then select Locations in the hierarchy.



8. Click **Details**, and then select Map.

A green line is now drawn between New York and Los Angeles.

9. Send an event with a severity of Critical to the device in New York. (For information about creating events, refer to the chapter titled Event Management.) Do not specify a component.

10. Return to the Locations map.

The dot representing New York is now red, but the link between New York and Los Angeles remains green.

11. Navigate to the New York device and determine the ID of the component that is connected to the network shared with the Los Angeles device.

12. Send another test event, this time specifying that component.

13. Return to the Locations map.

The link between New York and Los Angeles is now red.

## 9.6. Inheritance

Inheritance is defined by how many attributes are applied to a device at different points in the device hierarchy.

The following diagram shows an example of how and where configuration properties can be set throughout the device class tree.

**Figure 9.9. Device Class Tree and Inheritance**

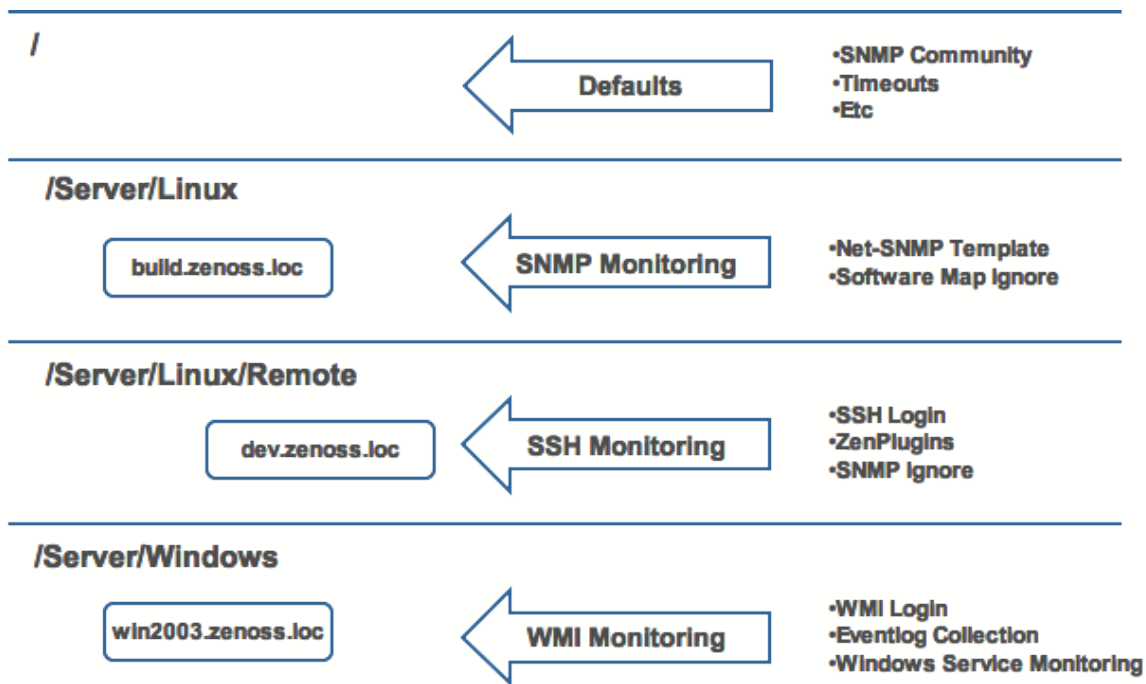

In this example, you can see that the default properties can be set at the highest level (/). However, as you travel further down the hierarchy, you see that you can override any of the configuration properties set at the root level.

The next two lines show how the device tree further defines properties for Linux servers. If you wanted, for example, to set up and use SNMP monitoring for all Linux servers (inclusive of) `build.zenoss.loc`, you could change these properties at the `/Server/Linux` level.

Further, if you wanted to change how you collect information for remote Linux servers, you could create a sub-group in `/Server/Linux` called `/Server/Linux/Remote`, setting these servers to use SSH monitoring and changing the associated properties for that sub-group.

Also within the `/Server` group you could create another sub-group for Windows servers that changes the configuration properties specifically for WMI monitoring.

All of these configuration properties and groupings co-exist, with any changes made lower in the hierarchy taking priority.

---

# Chapter 10. User Commands

## 10.1. About User Commands

User commands allow you to execute arbitrary shell commands from the Zenoss Core master server. A user command is executed on the server rather than the remote device unless the command explicitly uses SSH to connect to the remote device.

You can define and run user commands on a device or organizer (device class, system, group, or location). You also can define commands globally.

The following sections provide procedures for defining and running:

- Global user commands
- User commands for a single device
- User commands for multiple devices in an organizer

## 10.2. Defining Global User Commands

Global commands appear in the Commands list of options located at the top of the Devices page.

To define global user commands:

1. Select **Advanced > Settings** from the Navigation menu.
2. In the left panel, select **Commands**.
3. In the Define Commands area, select **Add User Command** from  (Action menu).

The Add User Command dialog appears.

4. Enter a name for the command, and then click **OK**.

The Define Commands page appears.

5. In the Description field, enter a description of what the command will do.
6. In the Command section, enter the TALES expression-based command you want to run on the device.
7. Enter your system account password for confirmation, and then click **Save**.

The command is saved and added to the commands menu.

### Note

Global commands also can be edited from a specific device. Changes to a global command from a device are not limited to that device.

### 10.2.1. Running Global User Commands

To run a global user command, select one or more devices in the devices list, and then select a command from the Commands list of options.

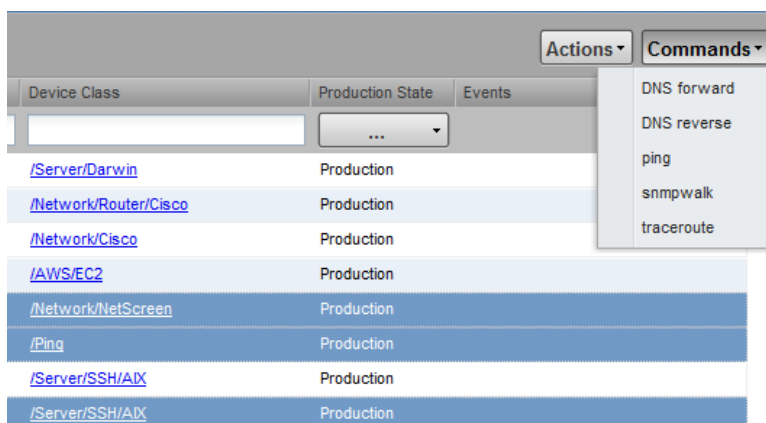
**Figure 10.1. Run Commands**

## 10.3. Defining User Commands for a Single Device

To define a user command for a device:

1. Select Infrastructure from the Navigation menu.

The Devices page appears.

2. Select a device from the list.

3. In the left panel, select Administration.

4. In the Define Commands area, select Add User Command from  (Action menu).

The Add User Command dialog appears.

5. Enter a name for the command, and then click **OK**.

The Define Commands page appears.

**Figure 10.2. Define User Command**

The screenshot shows the 'Define User Command' dialog box. It has a sidebar on the left with 'User Command' and 'Modifications' sections. The main area is titled 'Define Commands' and contains the following fields:

- Name:** test\_command
- Description:** (empty text area)
- Command:** (empty text area)
- Confirm Your Password:** (password input field)
- Save:** (button)

6. In the Description field, enter a description of what the command will do.

7. In the Command section, enter the TALES expression-based command you want to run.

8. Enter your system account password for confirmation, and then click **Save**.

The command is saved and added to the commands menu.

9. Optionally test the command by running it.

### 10.3.1. Running User Commands for a Single Device

To run a command defined for a single device:

1. Click the device name in the device list.

The device summary page appears.

2. Select the command from the Commands list of options located at the bottom of the page.

## 10.4. Defining User Commands for All Devices in an Organizer

To define a user command for all devices in an organizer:

1. Select an organizer in the devices hierarchy.

2. Click **Details**.

3. In the left panel, select Administration.

4. In the Define Commands area, select Add User Command from  (Action menu).

The Add User Command dialog appears.

5. Enter a name for the command, and then click **OK**.

The Define Commands page appears.

6. In the Description field, enter a description of what the command will do.

7. In the Command section, enter the TALEX expression-based command you want to run on the device.

8. Enter your system account password for confirmation, and then click **Save**.

The command is saved and added to the commands menu.

9. Optionally test the command by running it.

### 10.4.1. Running User Commands for Devices in an Organizer

To run a command defined for all devices in an organizer:

1. From the devices tree view, select an organizer.

2. Select one or more devices in the filtered view.

3. Select the command from the Commands list of options located at the top of the page.

## 10.5. User Command Example: Echo Command

This example shows how to create an echo user command. You can see the use of TALES expressions in the definition of this command.

1. Add a command called “echoDevice”
2. In the command definition, echo the name and IP address of the device:

```
echo name = ${here/id} ip = ${here/manageIp}
```

In a TALES expression, ‘here’ is the object against which the expression is executed. Some TALES expressions in the system have other variables (such as evt for event, and dev or device for the device). See the Appendix titled TALES Expressions for more information about TALES expressions syntax.

3. Select a device and then run the command.
  4. Edit the command to add more information:
- ```
echo name = ${here/id} ip = ${here/manageIp} hw = ${here/getHWProductName}
```
5. Run the command against a group of devices and view the command outputs.

---

# Chapter 11. Managing Users

## 11.1. About User Accounts

Each user has a unique user ID, which allows you to assign group permissions and notifications that are unique to each user. Unique IDs also help ensure secure access to the system.

To create and manage user accounts, you must be logged in to the system admin account, or as a user with extended privileges.

Read the following sections to learn how to:

- Create and edit user accounts
- Work with user groups
- Assign users to roles
- Set up access control lists (ACLs)

## 11.2. Creating User Accounts

To create a user account:

1. From the Navigation menu, select Advanced.

The Settings page appears.

2. In the left panel, select Users.

The users and groups administration page appears.

3. From  (Add Menu), select Add New User.

The Add User dialog appears.

4. In the Username field, enter a unique name for the account.

5. In the Email field, enter the user account email address. Any alerts that you set up for this user will be sent to this address.

6. Click **OK**.

The user appears in the User List.

After creating the account, edit the account to provide a password and additional user details.

## 11.3. Editing User Accounts

To access and edit user account information:

1. In the Users list, click the name of the user you want to edit.

The edit user page appears.

**Figure 11.1. Edit User**

2. Make changes to one or more settings:

- **New Password / Confirm New Password** - Enter and confirm a new password for the user.
- **Reset Password** - Facilitates user self-service by allowing a user to reset his password. Click to reset and email the new password to the email address associated with the user's account.
- **Roles** - Assign one or more roles (user privileges) to the user. To edit or assign roles, you must be a system Admin or be assigned the Manager role.

For more information about user roles, and for a list of available roles and the privileges they provide, see the section titled Roles in this chapter.

- **Groups** - Specify one or more groups to which this user belongs.
- **Email** - Enter the user's email address. To verify that the address is valid, click the test link.
- **Pager** - Enter the user's pager number.
- **Default Page Size** - Controls how many entries (by default) appear in tables. Enter a value for the default page size. The default value is 40.
- **Default Admin Role** - Select the default role that this user will have for administered objects associated with him.
- **Network Map Start Object** - Specify the default view for this user in the network map.

Enter your password, and then click **Save** to confirm and save your changes.

### 11.3.1. Associating Objects with Specific Users

You can associate any object in the system with a particular user, for monitoring or reporting purposes. Once associated with a user, you can then assign the user a specific role that applies to his privileges with respect to that object.

For more information about object-specific roles, see the section titled "Roles."



To create an object association:

1. From Advanced > Settings, select Administered Objects in the left panel.

The list of administered objects appears.

**Figure 11.2. Administered Objects - Add Object**

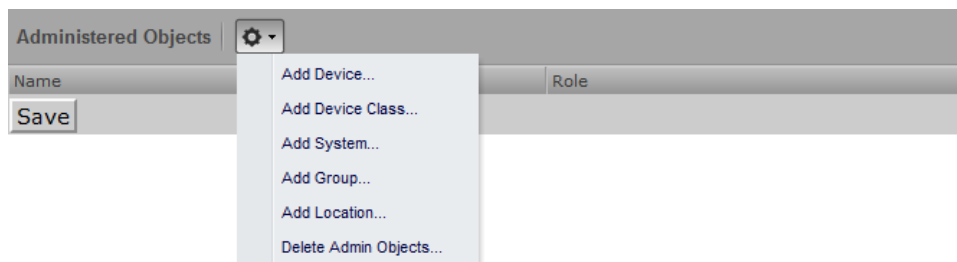

2. Select an object type from the Administered Objects Action menu. You can add:

- Device
- Device class
- System
- Group
- Location

The Add Administered Device dialog appears.

3. Specify the component you want to add as an administered object, and then click **OK**.

The object appears in the Administered Devices list for the user.

**Figure 11.3. Administered Objects - Objects Added**

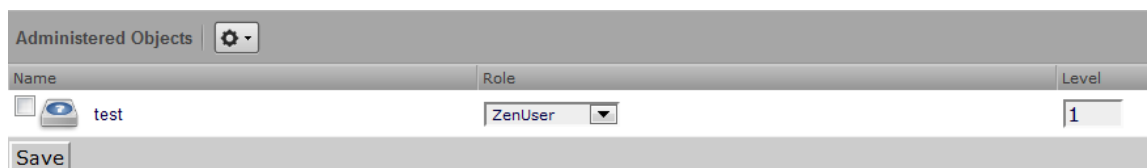

4. Optionally, change the role that is associated for this user on this object.

### Note

The default role assigned to the user for an administered object is specified by the Default Admin Role field on the Edit page.

5. Click **Save** to save changes.

### 11.3.1.1. Adding Administrators

You also can associate an object with a user by adding an administrator to the object. To do this:

1. Navigate to the object you want to add to the user's list of administered objects.
2. Select Administration.

**Figure 11.4. Administered Objects - Add Administrator**

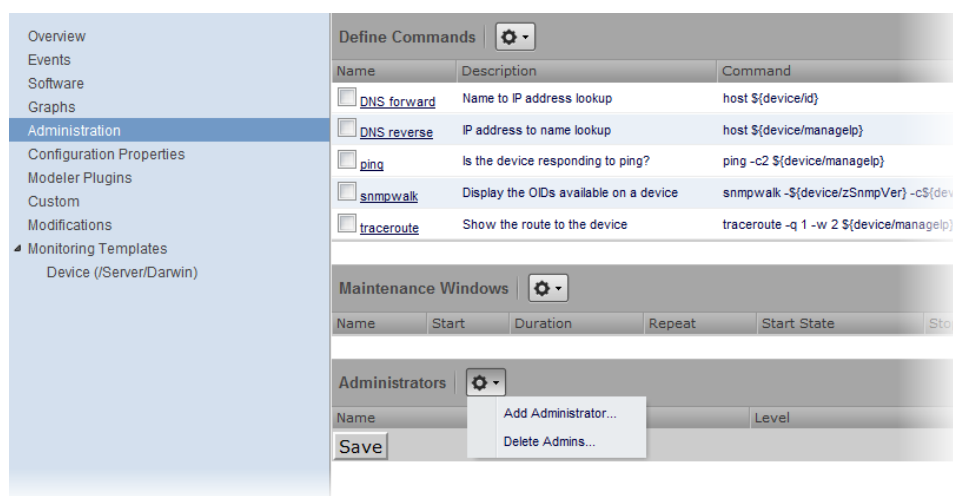

3. Select Add Administrator from the Actions menu in the Administrators area.

The Add Administrator dialog appears.

4. Select an administrator from the list, and then click **OK**.

The administrator appears in the object's Administrators list. The object is added to the user's Administered Objects list.

## 11.4. User Groups

Zenoss Core allows you to create user groups. By grouping users, you can aggregate rules and apply them across multiple user accounts.

### 11.4.1. Viewing User Groups

To view user groups, select Advanced > Settings, and then select Users from the left panel.

The groups area shows each user group and the users assigned to that group.

### 11.4.2. Creating User Groups

You can create user groups to aggregate rules and apply them across multiple user accounts.

To create a user group:

1. Select Advanced > Settings.
2. In the left panel, select Users

The Users page appears.

- From the Groups area Action menu, select Add New Group.

The Add Group dialog appears.

- In the Group field, enter a name for this user group, and then click **OK**.

The group name appears in the Groups list.

- Click the name of the group you created.

The Users in Group page appears.

- From the Action menu, select Add User.

The Add User to Group dialog appears.

**Figure 11.5. Add User to Group**

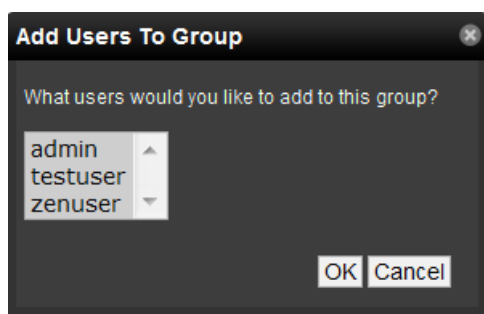

- From the User list of selections, select one or more users you want to add to the group, and then click **OK**.

The user or users you select appear in the list of users for this group.

You also can choose administered objects and notifications for this user group. They will apply to all users in the group. The user's original notifications and objects will also apply.

## 11.5. Roles

A role is a group of permissions that you can assign to users or groups.

The following table lists available roles.

| Role       | Definition                                                                                                                           |
|------------|--------------------------------------------------------------------------------------------------------------------------------------|
| ZenUser    | Provides global read-only access to system objects.                                                                                  |
| ZenManager | Provides global read-write access to system objects.                                                                                 |
| Manager    | Provides global read-write access to system objects. Additionally provides read-write access to the underlying Zope object database. |

# Chapter 12. Reporting

## 12.1. About Reporting

Zenoss Core aggregates and reports, over time, on the data you set it up to monitor. The system provides a range of defined and custom report options, including:

- Device reports
- Event reports
- Performance reports
- Graph reports
- Multi-graph reports
- Custom device reports

To work with reports, select Reports from the Navigation menu. The Reports list appears in the tree view. Expand a list item to see available reports in that category.

You can organize reports and report organizers by dragging and dropping in the tree view.

**Figure 12.1. Reports List**

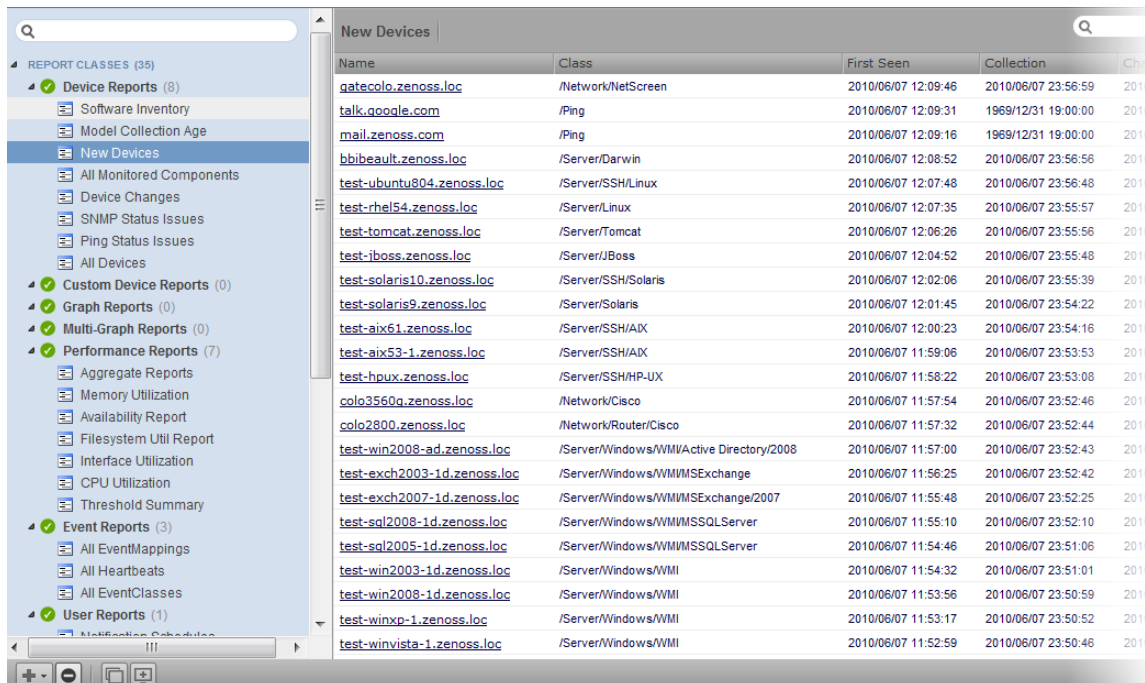

### 12.1.1. Organizing Reports

You can create report organizers at multiple levels. Select an existing organizer or the top of the reports hierarchy (Report Classes), and then select Add Report Organizer from  (Add Menu).

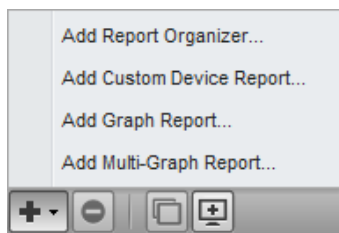
**Figure 12.2. Add Report Organizer**

## 12.2. Basic Reports

Basic reports included in the system are divided among:

- Device reports
- Event Reports
- Performance Reports

The following sections provide brief descriptions of reports offered in these categories.

### 12.2.1. Device Reports

Device reports aggregate and display data over system devices and device attributes. Reports in this category include:

- **All Devices** - Lists all devices with ping and SNMP status information.
- **All Monitored Components** - Shows all of the components currently being monitored. This does not include all components in the system, only those on which the system is currently collecting performance data. The information that appears in this report is:
  - Device name
  - Component
  - Type of component (when available)
  - Description
  - Status of each device
- **Device Changes** - Shows information about the history of any changes that the system detects when modeling each device. This report shows only devices with changes. Information available in this report includes:
  - Device name
  - Device class
  - Time when the device was first seen
  - Last time the system collected data on the device
  - Any changes made to configuration at last data collection
- **Model Collection Age** – Lists devices that have not, but should have been, modeled during the past 48 hours. Information available in this report includes:

- Device name
- Device class
- Time when the device was first seen by the system
- Last time the system collected data on the device
- Any changes made to configuration at last data collection
- **New Devices** – Lists devices that were recently added. The report shows:
  - Device name
  - Device class
  - Time when the device was first seen by the system
  - Model collection age
- **Ping Status Issues** – Lists devices that currently have, or have had, ping issues. The report shows:
  - Device name
  - Device class
  - Product name
  - Current state of the device
  - ping and SNMP status
- **SNMP Status Issues** - Lists devices that currently have, or have had, SNMP issues. The report shows:
  - Device name
  - Device class
  - product name
  - Current state of the device
  - ping and SNMP status
- **Software Inventory** - Lists software running on devices. This report includes:
  - Manufacturer
  - Product
  - Count

### 12.2.2. Event Reports

Event reports aggregate data about events, event mappings, and event classes.

- **All Heartbeats** – Shows heartbeats for monitored devices. Heartbeats are reported by component and number of seconds.

- **All Event Classes** – Shows all of the event classes that reside in the system. The report breaks these classes down by sub-classes, the number of instances of that class in the system, and the number of events in the system associated with each event class.
- **All Event Mappings** – Shows all of the event mappings you have created in the system. You can sort the report by event class key, evaluation, or number of events for each event class.

### 12.2.3. Performance Reports

Performance reports provide performance data across the system.

- **Aggregate Reports** – Show the performance graphs for devices in the system, in graphical format. Common performance statistics include:
  - CPU usage
  - Aggregate free memory
  - Aggregate free swap
  - Network output and input

Click the graph to edit graph parameters. You can:

- Change the values for width, height, Min Y, and Max Y axis.
- Specify which devices are aggregated
- Set the time span for the graph
- **Availability Report** – Shows the percentage of time that a device or component is considered available. You can filter this report on device, component, event class, or severity. You also can further limit the time frame for the availability.

The value for a date range is calculated by summing the duration of all events of a particular class with a production state of "Production" and with a severity greater than or equal to a specified severity. This sum is then divided by the duration of the time range, and then subtracted from 1 and multiplied by 100 to get the percent available, as in:

$$(1 - \text{Total event down time}) / (\text{date range}) * 100$$

#### Note

Events whose firsttime and lasttime fields are the same are not used in the calculation. These could represent an event that occurs and is subsequently cleared by the next event, or an event that has happened only once in the specified date range.

- **CPU Utilization Report** – Shows monitored interfaces, devices, load average, and % utility. You can customize start and end dates, and summary type (average or maximum).

This report uses data point aliases. (For more information about data point aliases, see "Data Point Aliases" in the chapter titled Core Monitoring.) To add data points to a report, add the alias, and then ensure the values return in the expected units.

| Alias           | Expected Units |
|-----------------|----------------|
| loadAverage5min | Processes      |

| Alias   | Expected Units |
|---------|----------------|
| cpu_pct | Percent        |

- **Filesystem Utilization Report** – Shows total bytes, used bytes, free bytes, and percentage utilization for each device. You can customize start and end dates, and summary type (average or maximum).

This report uses data point aliases. (For more information about data point aliases, see "Data Point Aliases" in the chapter titled Core Monitoring.) To add data points to a report, add the alias, and then ensure the values return in the expected units.

| Alias                      | Expected Units |
|----------------------------|----------------|
| usedFilesystemSpace__bytes | bytes          |

- **Interface Utilization** - Shows the traffic through all network interfaces monitored by the system. Columns included in the report are:

- Device - Interface's device.
- Interface - Interface.
- Speed - Interface's rated bandwidth, in bits per second.
- Input - Average traffic going out of the interface, in bits per second.
- Output - Average traffic coming in to the interface, in bits per second.
- Total - Total average traffic across the interface, in bits per second.
- % Util - Average fraction of the interface's bandwidth consumed.

This report uses data point aliases. (For more information about data point aliases, see "Data Point Aliases" in the chapter titled Core Monitoring.) To add data points to a report, add the alias, and then ensure the values return in the expected units.

| Alias               | Expected Units |
|---------------------|----------------|
| inputOctets__bytes  | bytes/sec      |
| outputOctets__bytes | bytes/sec      |

- **Memory Utilization** – Provides system-wide information about the memory usage for devices in the system. This report shows:

- Total memory
- Available memory
- Cache memory
- Buffered memory
- Percentage of memory utilized

This report uses data point aliases. (For more information about data point aliases, see "Data Point Aliases" in the chapter titled Core Monitoring.) To add data points to a report, add the alias, and then ensure the values return in the expected units.



| Alias                  | Expected Units |
|------------------------|----------------|
| memoryAvailable__bytes | bytes          |
| memoryBuffered__bytes  | bytes          |
| memoryCached__bytes    | bytes          |

- **Threshold Summary** – Identifies the devices that approach or exceed their thresholds. You can see the device, the component, the event class, count, duration, and percentage. You can filter this list by event class; or, to see all event classes, leave the event class Selection List blank. You also can change the start and end dates for the reporting data.

## 12.3. Graph Reports

Graph reports allow you to assemble graphs from devices and device components into a single report.

Graph reports display only those graphs that already exist on devices or components in the system. You cannot define or alter graphs from a graph report.

**Figure 12.3. Graph Report**

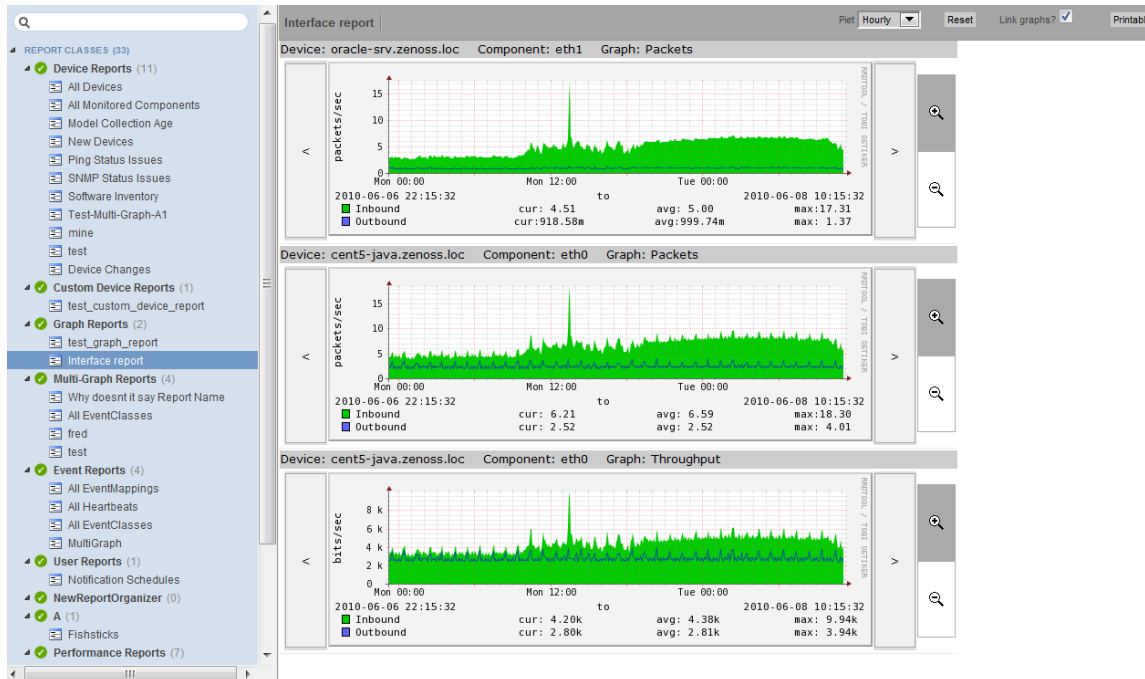

Graph reports are available in two views: a "normal" view (similar to the graph views for devices and device classes), and a print view.

### 12.3.1. Creating a Graph Report

Follow these steps to create a graph report:

1. In the tree view, select Add Graph Report from  (Add Menu).
2. In the Create Graph Report dialog, enter a name for the report, and then click **Submit**.

The Graph Report edit page appears.

3. Enter information or make selections to define the report:

- **Name** - The name of the report, as defined in the Create Graph Report dialog.
- **Title** - Enter a descriptive title to display in the list of reports for the report organizer.
- **Number of Columns** - Specify the number of columns (1-3) in which graphs will be displayed on the report.
- **Comments** - Enter comments to display at the top of the printable version of the report. This is a TALEs evaluated string that can contain HTML formatting. The variables available to the TALEs expression are:
  - now (current date and time)
  - report (report object)

4. Click **Save** to save the new graph report.

### 12.3.1.1. Adding Graphs

The Add New Graph section of the edit page allows you to add one or more graphs to the report. To do this:

1. Select one or more devices.

#### **Tip**

You can narrow the list of devices by entering a search string, and then clicking **Filter**.

2. Optionally, select one or more components from the Components list. This list displays the names of all components defined on at least one of the selected devices.
3. Select one or more graphs from the Graph list. This list displays the names of all graphs available for the selected devices; or, if you have selected one or more components, the graphs available for the components.
4. Click **Add Graph to Report**.

The system evaluates each selected device (or component, if selected), and searches for graphs. Matching graphs are added to the graph report. The graph is listed at the bottom of the page in the Graphs area.

**Figure 12.4. Add Graph**

Graph reports maintain a static list of graphs. This list does not change when graphs are added or deleted from monitoring templates.

For example, you have two devices with associated graphs:

- DeviceA - Has a single graph (Graph1)
- DeviceB - Has two graphs (Graph1 and Graph 2)

If you select DeviceA and DeviceB on the Graph Report edit page, the list of graphs will include Graph1 and Graph2. If you select both graphs and then click Add Graph to Report, then three graphs are added to the report:

- DeviceA - Graph1
- DeviceB - Graph1
- DeviceB - Graph2

If at a later time you create a second graph (Graph2) on DeviceA's monitoring templates, that new graph will not automatically appear on the graph report. (You must edit the report to add it.) Similarly, if you later remove a graph from DeviceB's template (or delete DeviceB from the system), you must manually remove the graph (or device) from the graph report.

### 12.3.2. Customizing Graph Text

The Graphs area of the edit page lists the graphs that are included in the report. Click a graph name to view its edit page. From here, you can edit the text that appears with the graph when viewing the report:

- **Summary** - Displays above the graph in the normal report view. May contain TALEs expressions with these variables:
  - dev - Device
  - comp - Component
  - graph - Graph
- **Comments** - Display to the left of the graph in the printable view. May contain TALEs expressions with these variables:
  - dev - Device
  - comp - Component
  - graph - Graph

### 12.3.3. Printing Graphs

To see the print view, click **Printable** at the top of the report view. The system renders a printable view.

### 12.3.4. Organizing Graphs

In normal and print views, graphs are shown from left to right, in the number of columns specified on the report edit page. If the report contains more than three graphs, the additional graphs are ordered left to right on subsequent lines.

In the report view, you can alter the sequence of graphs in the edit page to control the location each graph appears in that view. To change the sequence, edit the values in the Seq column next to each graph name, and then choose Re-sequence Graphs.

## 12.4. Multi-Graph Reports

Multi-graph reports combine data from different devices and components into a single report. You can create a graph definition and have it drawn once for each of a group of devices and components that you define. Alternatively, you can combine the data for those graphs into a single graph.

The groups of devices and components you assemble are called *collections*. Specifying the graph definitions to apply to collections is done through graph group objects.

Multi-graph reports include their own graph definitions, and thus do not use the graph definitions that are defined in monitoring templates. (To create a report that includes graphs defined on templates, use a graph report.)

Like graph reports, multi-graph reports offer two different views: normal and print.

### 12.4.1. Creating A Multi-Graph Report

To create a multi-graph report:

1. From a report organizer or sub-organizer in the tree view, select Add Multi-Graph Report from the Add Menu.

The Create Multi-Graph Report dialog appears.

2. Enter a name for the report, and then click **Submit**.

3. In the report edit page, enter or select values for:

- **Name** - Displays at the top of the report.
- **Title** - Displays at the top of the printable version of the report.
- **Number of Columns** - Specifies the number of columns (1-3) in which graphs will appear on the report.

After creating the multi-graph report, you must also add one or more:

- Collections, which contain the devices and components you want to graph
- Graph definitions, which describe the graphs you want on the report
- Graph groups, which specify the collection and graph definition.

**Figure 12.5. Multi-Graph Report Edit Page**

State at time: 2010/04/14 12:31:56

Name: test\_multi-graph\_report

Title:

Number of Columns: 1

Save

Collections [gear icon]

| Name | Number of Items |
|------|-----------------|
|------|-----------------|

Graph Definitions [gear icon]

| Name | Graph Points | Units | Height |
|------|--------------|-------|--------|
|------|--------------|-------|--------|

Graph Groups [gear icon]

| Seq | Name | Collection | Graph Definition |
|-----|------|------------|------------------|
|-----|------|------------|------------------|

### 12.4.1.1. Adding Collections

A *collection* comprises one or more *collection items*. A collection item can be a list of device classes, systems, groups, locations, or specific devices or components. A single collection may contain as many collection items as desired.

A multi-graph report must contain at least one collection. Collections are shown in the Collections area of the report's edit page.

To create a collection:

1. Select Add Collection from  (Action Menu).

The Add a Collection dialog appears.

2. Enter a name for the collection, and then click **OK**.

To add collection items to a collection:

1. Select a value for Item Type. The Item type menu lets you select:
  - Device Class/System/Group/Location - Selecting one of these options reveals a list of all organizers of that type. You can select one or more of the organizers to include in the collection.
  - Specific Device/Component - Selecting this option reveals a list of all devices. You can use the Filter field to narrow this list by entering a full or partial device name. Selecting one or more devices will display a list of component names that apply to one or more of the selected devices.
2. Select a value for Include Suborganizers. If true, then the collection will also include all organizers recursively beneath the selected organizer. These collection items are dynamic: when devices are added or removed from the organizers, they will appear or disappear from the report.
3. Click **Add to Collection** to create a new collection item for each of the selected organizers or specific device.

You can re-order collection items. Their listed order determines the order in which the graphs are drawn, or the order that data is drawn on a combined graph.

**Figure 12.6. Multi-Graph Report Collection**

Reports > Multi-Graph Reports > test\_multi-graph\_report > test\_collection

State at time: 2010/06/08 10:13:19

Name: test\_collection [Save]

Add To Collection

Item Type: Device Class

Device Class: /Discovered, /Network, /Server, /Printer, /Power, /KVM, /Ping, /HTTP, /AWS, /Web

Include Suborganizers?: True

[Add to Collection]

Collection Items [Settings]

| Seq | Name | Item Description | Number of Devices/Components |
|-----|------|------------------|------------------------------|
|-----|------|------------------|------------------------------|

### 12.4.1.2. Adding Graph Definitions

In the context of multi-graph reports, graph definitions are very similar to those in monitoring templates. Settings on the graph definition define basic parameters; graph points are added to specify which data should be drawn. (For more information on creating graph definitions, see the chapter titled Performance Monitoring.)

The most significant differences between graph definitions in the two contexts is how data point graph points and threshold graph points are added. When adding a data point graph point to a graph definition in a performance template,

you can select from a list of data points that are defined on that template. In the context of a multi-graph report, there are no graph point definitions listed; you must enter the name of the data point on the data point graph point dialog.

To add a graph definition:

1. Select Add Graph from  (Action Menu) in the Graph Definitions area of the graph edit page.

The Add a New Graph dialog appears.

2. Enter a name for the graph, and then click **OK**.

The edit page appears.

**Figure 12.7. Multi-Graph Report Graph Definition**

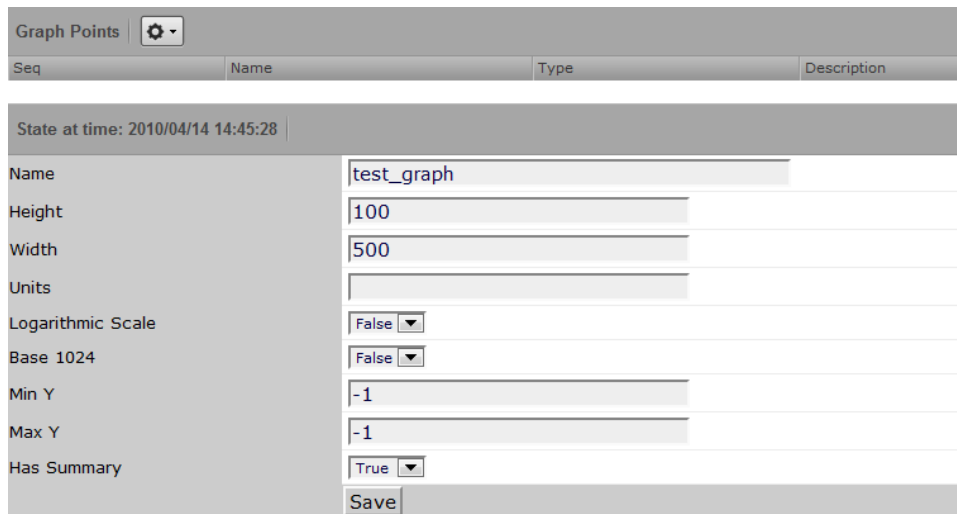

| Seq                                | Name              | Type       | Description |
|------------------------------------|-------------------|------------|-------------|
| State at time: 2010/04/14 14:45:28 |                   |            |             |
|                                    | Name              | test_graph |             |
|                                    | Height            | 100        |             |
|                                    | Width             | 500        |             |
|                                    | Units             |            |             |
|                                    | Logarithmic Scale | False      |             |
|                                    | Base 1024         | False      |             |
|                                    | Min Y             | -1         |             |
|                                    | Max Y             | -1         |             |
|                                    | Has Summary       | True       |             |
| Save                               |                   |            |             |

From the Action menu on this page, you can:

- Add data points and thresholds
- Delete the graph point
- Re-sequence graph points

### 12.4.1.3. Adding Graph Groups

Graph groups combine a graph definition with a collection to produce graphs for the report. Without at least one graph group, the report will show no graphs.

To create a graph group:

1. Select Add Group from  (Action Menu) in the Graph Groups area of the graph edit page.

The Add a New Graph Group dialog appears.

2. Enter a name for the graph group, and then click **OK**.
3. Enter information or make selections on the edit page:

- **Name** - Identifies the graph group on the multi-graph report page. It does not appear on the report.
- **Collection** - Select a collection that has been defined for this report.
- **Graph Definition** - Select a graph definition that has been defined for this report.
- **Method** - Choose to have the graph drawn once for each device and component in the collection, or combine the data from all devices and components into a single graph. Options are:
  - Separate graph for each device - The graph definition is used to draw one graph for each device and component in the collection. Graphs will appear in the list in roughly the same order they are specified in the collection.
  - All devices on a single graph - Draws one graph with the data from all devices and components included.

4. Click **Save** to save the graph group.

**Figure 12.8. Multi-Graph Report Graph Group**

State at time: 2010/04/14 14:54:15

Name: test\_graph\_group

Collection: [dropdown]

Graph Definition: test\_graph [dropdown]

Method: Separate graph for each device [dropdown]

Save

#### 12.4.1.3.1. Graph Order

Graph groups are drawn in the order listed on the multi-graph report edit page. You can change the order of the graph groups:

1. In the Seq column of the Graph Groups area, enter numbers next to one or more graph groups.
2. Select Re-sequence items from Actions Menu.

The page refreshes and displays the graph groups in the re-sequenced order.

### Note

If a graph group results in multiple graphs, then the graphs are drawn in the order that the collection items are listed the corresponding collection. If a collection item specifies a device organizer, then the order of the devices drawn from that collection item is indeterminate.

## 12.5. Creating Custom Device Reports

Follow these steps to create a custom device report:

1. From the Web interface, select Reports.
2. In the tree view, select Custom Device Reports.



3. From  (Add Menu), select Add Custom Device Report.

The Create Custom Device dialog appears.

4. Enter a name for the report, and then click **Submit**.

The graph edit page appears.

5. Define report parameters, as follows.

- **Name** - Optionally edit the report name.
- **Title** - Enter a report title. This title shows in the report display, and is distinct from the report name.
- **Path** - Specify the path in the hierarchy where you want the system to store the report.
- **Query** - Specify the actual query string for the report. If you want to limit the report to just those devices with a serial number, for example, you can set the Query value to:

```
here.hw.serialNumber != ""
```

- **Sort Column** - Specify the column on which you want to sort the report by default.
- **Sort Sense** - Specify the sense that the system uses to sort: asc (ascending sort) or desc (descending sort).
- **Columns** - Specify the data to be retrieved and displayed in the report. For example, you could specify:
  - **getId** - Gets the name of any devices.
  - **getManageIp** - Gets the IP addresses of the devices.
  - **getHWSerialNumber** - Grabs serial numbers for the devices.

## Note

For a complete list of valid options, refer to the information on Device schema in the appendix titled "TALES Expressions."

- **Column Names** - Optionally specify column names to make the column headers more descriptive.

For the columns specified in the previous example, you could use these column names:

- Device
- Address
- Serial #

6. Click **Save** to save the report.

## 12.6. Exporting Reports

You can export data from any report as comma-separated value (.csv) files.

To export report data:

1. Click **Export All** (located at the bottom of a report).

2. In the dialog that appears, open or save the `zenoss_export.csv` file.

## 12.6.1. Advanced Task: Add An Export Button to a Report

You can edit any report to add an Export All button to export data.

The report format appears similar to this:

```
<tal:block tal:define="
  objects python:here.ZenUsers.getAllThingsForReport();
  objects python: (hasattr(request, 'doExport') and list(objects)) or objects;
  tableName string: thisIsTheTableName;
  batch python:here.ZenTableManager.getBatch(
    tableName,objects, sortedHeader='getUserid');
  exportFields python:[
    'getUserid', 'id', 'delay', 'enabled', 'nextActiveNice',
    'nextDurationNice', 'repeatNice', 'where'];
">

<tal:block metal:use-macro="here/reportMacros/macros/exportableReport">
<tal:block metal:fill-slot="report"

<!-- Normal Report Markup Here -->

</tal:block>
</tal:block>
</tal:block>
```

Notable details in this example are:

- The first definition is a call to a method that retrieves the objects for the report. This might be a list, tuple, or iterable class.
- The second `tal:define` line ensures that there is a list in the event being exported. (Do not do this unless doing an export; large reports may encounter performance issues if an iterable is unnecessarily converted to a list.)
- `tablename` is defined for use by the `getBatch()` call that follows.
- `exportFields` is a list of data to be included in the export. These can be attribute names or names of methods to call. See `DataRoot?.writeExportRows()` for more details on what can be included in this list.
- Within the `<tal:block metal:fill-slot="report"></tal:block>` block goes the report markup to use when not including the export functionality.
- If the Export All button does not appear to function, you may need to use `zenTableNavigation/macros/navtool` rather than `zenTableNavigation/macros/navbody` in your report. The former includes the `<form>` tag; the latter does not. If you are not providing a `<form>` tag then you need to use `navtool` so the export button is within a form.

## 12.7. Scheduling Reports

By default, all reports run on demand, presenting information when you run the report. To schedule reports, you can use the `reportmail` tool. This allows you to select a report and email its output to a list of recipients according to a pre-determined schedule. `reportmail` is a command line tool that is designed primarily to be run out of the UNIX crontab, allowing for flexible scheduling.

The following steps demonstrate how you would set up the standard Availability Report to be emailed to `<joe@example.com>` every Monday morning at 6 a.m.

1. Locate the URL to the Availability Report by navigating to it in the Web interface.

|                                       |                                                  |            |                      |
|---------------------------------------|--------------------------------------------------|------------|----------------------|
| Device:                               | <input type="text"/>                             | Component: | <input type="text"/> |
| Start Date:                           | 04/06/2010 <input type="button" value="select"/> | End Date:  | 04/13/2010           |
| Event Class:                          | /Status/Ping <input type="button" value="v"/>    | Severity:  | Error                |
| <input type="button" value="Update"/> |                                                  |            |                      |
| <b>Device Availability</b>            |                                                  |            |                      |
| Device                                | Component                                        | Systems    |                      |
| <a href="#">osmium.zenoss.loc</a>     |                                                  |            |                      |
| <a href="#">yttrium.zenoss.loc</a>    |                                                  |            |                      |
| <a href="#">silicon.zenoss.loc</a>    |                                                  |            |                      |
| <a href="#">boron.zenoss.loc</a>      |                                                  |            |                      |
| <a href="#">strontium.zenoss.loc</a>  |                                                  |            |                      |

2. Log in to your Zenoss Core server and switch to the zenoss user by running the command:

```
su - zenoss
```

3. Create a script that will invoke `reportmail` with the appropriate options, using the following commands:

```
mkdir -p $ZENHOME/scripts
cat <<EOF > $ZENHOME/scripts/emailAvailabilityToJoe.sh
#!/bin/sh
REPORTS_URL=http://public-demo.zenoss.com:8080/zport/dmd/Reports

$ZENHOME/bin/reportmail \
--user=admin \
--passwd=PASSWD \
--from="zenoss@example.com" \
--address="joe@example.com" \
--subject="Zenoss Core: Availability Report" \
--url="$REPORTS_URL/Performance Reports/Availability Report"
EOF

chmod 755 $ZENHOME/scripts/emailAvailabilityToJoe.sh
```

## Note

For help on `reportmail` options, run **reportmail --help** on your Zenoss Core server.

4. Run **crontab -e** to edit the zenoss user's `crontab`. You will be presented with an editor that allows you to set up scheduled commands.
5. Add a new line, and then enter the following job definition:

```
# Email availability report to Joe every Monday morning at 6am.
0 6 * * 1 bash -lc '$ZENHOME/scripts/emailAvailabilityToJoe.sh'
```

## Note

Run the following command on your system server for help on `crontab` formatting:

```
man 5 crontab
```

6. Save the `crontab`.

## 12.7.1. ReportMail Command Line Arguments

The following table contains all of the command line arguments for the `reportmail` tool.

| Argument                           | Explanation                                                                                                                                                                                                      |
|------------------------------------|------------------------------------------------------------------------------------------------------------------------------------------------------------------------------------------------------------------|
| -u URL, --url=URL                  | Uniform Resource Locator of report to send. This also can be the URL of any other page in the system.                                                                                                            |
| -U USER, --user=USER               | User to log in to the system. This user must have permission to view the supplied URL.                                                                                                                           |
| -p PASSWD, --passwd=PASSWD         | Password to log in to the system.                                                                                                                                                                                |
| -a ADDRESS, --address=ADDRESS      | Email address for report delivery (may be given more than once.) Default value comes from the user's profile.                                                                                                    |
| -s SUBJECT, --subject=SUBJECT      | Subject line for email message. Default value is the title of the page.                                                                                                                                          |
| -f FROMADDRESS, --from=FROMADDRESS | Origination address for the email being sent.                                                                                                                                                                    |
| -d DIV, --div=DIV                  | DIV to extract from the HTML at URL. The default value is contentPane, which will work for all default reports.                                                                                                  |
| -c COMMENT, --comment=COMMENT      | Comment to include in the body of CSV reports. This is used only if the URL returns comma-separated value data. Most default reports can return CSV-formatted data by appending ?doExport to the end of the URL. |

## 12.8. Using Reports to Troubleshoot System Daemons

This section shows how to find and view certain reports that can aid you when troubleshooting system daemons.

From the Web interface, navigate to Reports. Use the tree view to locate the various reports listed below to see the reports. The troubleshooting items indicate what you might find in the various reports.

| Troubleshooting Items                                                     | Report Name            |
|---------------------------------------------------------------------------|------------------------|
| zenmodeler issues                                                         | Model Collection Age   |
| Internal issues                                                           | All Heartbeats         |
| zendisc errors, adding devices                                            | New Devices            |
| Notification issues, will show all rules in the system                    | Notification Schedules |
| Summary of SNMP status across the system, including non-monitored devices | SNMP Status Issues     |
| Which devices are monitored and whether ping is turned on or off          | Ping Status Issues     |

---

# Chapter 13. ZenPacks

Read this chapter for information about viewing, installing, and upgrading ZenPacks.

## 13.1. About ZenPacks

ZenPacks extend and modify the system to add new functionality. This can be as simple as adding new device classes or monitoring templates, or as complex as extending the data model and providing new collection daemons.

You can use ZenPacks to add:

- Monitoring templates
- Data sources
- Graphs
- Event classes
- User commands
- Reports
- Model extensions
- Product definitions

Simple ZenPacks can be created completely within the user interface. More complex ZenPacks require development of scripts or daemons, using Python or another programming language.

ZenPacks can be distributed for installation on other Zenoss Core systems.

## 13.2. Viewing ZenPacks

To see which ZenPacks are loaded on your system:

1. From the Navigation menu, select Advanced.

The Settings page appears.

2. Select ZenPacks in the left panel.

The list of loaded ZenPacks appears.

**Figure 13.1. Loaded ZenPacks**

The screenshot shows a table titled 'Loaded ZenPacks' with columns for Pack, Package, Author, Version, and Egg. An action menu is open over the first row, showing options: 'Create a ZenPack...', 'Install ZenPack...', and 'Delete ZenPack...'. The table lists various ZenPacks such as ZenPacks.zenoss, ZenPacks.zenoss.AuditLog, ZenPacks.zenoss.AutoTune, etc.

| Pack                                                       | Package | Author | Version | Egg |
|------------------------------------------------------------|---------|--------|---------|-----|
| <input type="checkbox"/> ZenPacks.zenoss                   | zenoss  | Zenoss | 2.0.1   | Yes |
| <input type="checkbox"/> ZenPacks.zenoss                   | zenoss  | Zenoss | 1.0.5   | Yes |
| <input type="checkbox"/> ZenPacks.zenoss.zenoss.AuditLog   | zenoss  | Zenoss | 1.1.5   | Yes |
| <input type="checkbox"/> ZenPacks.zenoss.ApacheMonitor     | zenoss  | Zenoss | 2.1.3   | Yes |
| <input type="checkbox"/> ZenPacks.zenoss.AuditLog          | zenoss  | zenoss | 1.1.2   | Yes |
| <input type="checkbox"/> ZenPacks.zenoss.AutoTune          | zenoss  | Zenoss | 0.1     | Yes |
| <input type="checkbox"/> ZenPacks.zenoss.BiIpMonitor       | zenoss  | Zenoss | 2.3.1   | Yes |
| <input type="checkbox"/> ZenPacks.zenoss.BrocadeMonitor    | zenoss  | Zenoss | 2.0.6   | Yes |
| <input type="checkbox"/> ZenPacks.zenoss.CheckPointMonitor | zenoss  | Zenoss | 1.0.4   | Yes |
| <input type="checkbox"/> ZenPacks.zenoss.CiscoMonitor      | zenoss  | Zenoss | 3.0.4   | Yes |
| <input type="checkbox"/> ZenPacks.zenoss.CiscoUCS          | zenoss  | Zenoss | 1.6.0   | Yes |
| <input type="checkbox"/> ZenPacks.zenoss.DellMonitor       | zenoss  | Zenoss | 2.1.0   | Yes |
| <input type="checkbox"/> ZenPacks.zenoss.DeviceSearch      | zenoss  | Zenoss | 1.2.0   | Yes |
| <input type="checkbox"/> ZenPacks.zenoss.Diagram           | zenoss  | Zenoss | 1.1.2   | Yes |
| <input type="checkbox"/> ZenPacks.zenoss.DigMonitor        | zenoss  | Zenoss | 1.0.3   | Yes |

From the action menu on this page, you can create, install, and delete ZenPacks.

## Note

Alternatively, you can view loaded ZenPacks from the command line:

```
zenpack --list
```

## 13.3. Installing ZenPacks

ZenPacks are distributed as `.egg` files. You can install ZenPacks from the user interface, or from the command line on the Zenoss Core server.

### 13.3.1. Installing from the User Interface

To upload and install a ZenPack `.egg` file from the user interface:

1. From the Navigation menu, select Advanced > Settings.
2. In the left panel, select ZenPacks.
3. From  (Action menu), select Install ZenPack.

The Install ZenPack dialog appears.

4. Browse to and select the `.egg` file you want to install, and then click **OK**.

The file is uploaded to the Zenoss Core server and installed.

## Note

After installing the ZenPack, restart the system.

### 13.3.2. Installing from the Command Line

Use these commands to install a ZenPack file and then restart the system:

```
zenpack --install FileName
```

```
zenoss restart
```

If you have the source code for the ZenPack you can install directly from that rather than from an `.egg` file. The command is the same; however, you must specify the directory containing the source code. This copies the source code to `$ZENHOME/ZenPacks`:

```
zenpack --install DirectoryName
zenoss restart
```

If you are developing a ZenPack, you should maintain your source code outside of `$ZENHOME/ZenPacks`, for two reasons:

- If you issue a **zenpack --remove** command it will delete your code from that location and you will lose your files unless you have them backed up elsewhere.
- if you are maintaining your source code in a version control system it is frequently more convenient to have the files reside elsewhere on the file system.

Using the **--link** option, you can install the ZenPack but have the system use your code from its current location. Instead of installing your code in `$ZENHOME/ZenPacks`, the system will create a link in that location that points to your source code directory.

```
zenpack --link --install DirectoryName
zenoss restart
```

## 13.4. Upgrading ZenPacks

To upgrade a ZenPack, install the new `.egg` file:

```
zenoss --install FileName
```

Do not remove the old ZenPack before installing the new file. Doing this usually removes any devices created under the ZenPack's device classes.

## 13.5. Deleting ZenPacks

Deleting a ZenPack can have unexpected consequences. Before you take this action, consider that:

- Deleting a ZenPack will delete all objects provided by the ZenPack, as well as all objects that depend on code provided by the ZenPack. Zenoss recommends that you view a ZenPack's detail page to see its dependencies, files, and classes before removing it.
- Removing a ZenPack that installs a device class removes the device class, any contained device classes, and all devices in that class.

Before removing a ZenPack, you should:

- Delete any data source of a type provided by the ZenPack
- Back up your system data. (See the section titled "Backup and Restore" in *Zenoss Core Administration* for information on backing up system data.)

To delete a ZenPack:

1. Select the ZenPack from the Loaded ZenPacks list.
2. Select Delete ZenPack from the Action menu.

3. Click **OK** to confirm removal.

### **Note**

If the ZenPack includes daemons, you must manually stop these after deleting the ZenPack.

## **13.6. ZenPack Information Resources**

Zenoss provides numerous ZenPacks that add and extend system functionality. The guide titled *Zenoss Core Extended Monitoring* provides detailed descriptions, installation information, and configuration details for these ZenPacks.

For ZenPack development procedures and best practices, refer to the chapter titled "ZenPacks" in the *Zenoss Developer's Guide*.

Discussions about ZenPack development and implementation take place at these Community locations:

- <http://community.zenoss.org/community/forums/zenoss-zenpacks>
- [http://community.zenoss.org/community/developers/zenpack\\_development](http://community.zenoss.org/community/developers/zenpack_development)
- <https://github.com/zenoss>



---

# Chapter 14. General Administration and Settings

Read the following sections to learn more about performing general administration tasks, including:

- Adjusting events settings
- Enabling HTTPS support
- Setting portlet permissions
- Performing backup and recovery tasks
- Viewing, starting, and stopping jobs
- Host name changes
- Viewing versions and checking for updates

## 14.1. Events Settings

You can adjust events settings for:

- Events database connection
- Event maintenance

### 14.1.1. Changing Events Database Connection Information

To edit events database connection settings, make changes in the `zeneventserver.conf` file. You can edit the file directly, or run a configuration script.

Configurable database connection settings are:

- **JDBC Hostname** (`zep.jdbc.hostname`) - Specify the IP address of the host.
- **JDBC Port** (`zep.jdbc.port`) - Specify the port to use when accessing the events database.
- **JDBC Database Name** (`zep.jdbc.dbname`) - Specify the database name.
- **JDBC Username** (`zep.jdbc.username`) - Specify the user name for the database.
- **JDBC Password** (`zep.jdbc.password`) - Specify the password for the database.

To edit these values, run the `zeneventserver` configuration script, as follows:

```
zeneventserver-config -u zep.jdbc.Name=Value
```

Where *Name* is the partial setting name and *Value* is the value you want to specify for the setting.

### 14.1.2. Changing Events Maintenance Settings

To edit maintenance settings, make changes to one or more fields on the Event Configuration page (Advanced > Settings > Events):

- **Don't Age This Severity and Above** - Select a severity level (Clear, Debug, Info, Warning, Error, or Critical). Events with this severity level and severity levels above this one will not be aged by the system.
- **Event Aging Threshold** (minutes) - Specify how long the system should wait before aging an event.
- **Event Archive Interval** (minutes) - Specify how long a closed event remains in the Event Console before moving to the event archive.
- **Delete Archived Events Older Than** (days) - Enter a value in days. Zenoss Core will automatically delete events from the event archive that are older than this value.
- **Default Syslog Priority** - Specify the default severity level assigned to an event coming from zensyslog if no priority can be determined from the event.
- **Default Availability Report** (days) - Enter the number of days to include in the automatically generated Availability Report. This report shows a graphical summary of availability and status.

## 14.2. Rebuilding the Events Index

If you encounter inconsistent search results, you can rebuild the events index. As the zenoss user, follow these steps:

1. Stop zeneventserver:

```
zeneventserver stop
```

2. Delete the index:

```
rm -rf $ZENHOME/var/zeneventserver/index
```

3. Restart zeneventserver:

```
zeneventserver start
```

Depending on the number of events in the database, it may take a significant amount of time for indexing to complete. Until every event is indexed, the number of events shown in the event console may be inconsistent.

## 14.3. Enabling HTTPS Support

If you want to set up SSL without rewrite rules on the upstream proxy (for example, Apache mod\_proxy), you must enable HTTPS support in Zope. This forces Zope to use HTTPS refs when parsing `absolute_url` paths.

Edit the `zope.conf` file to include this directive, and then restart `zopectl`:

```
<cgi-environment>  
  HTTPS ON  
</cgi-environment>
```

### Note

This setting forces all connections to use HTTPS.

## 14.4. Setting Portlet Permissions

By setting permissions, you determine which users can view and interact with portlets. Permissions settings restrict which Zope Access Control List (ACL) can access each portlet.

Before you can successfully set portlet permissions, you must assign the user a specific Zenoss Core role. (You assign roles from the user edit page, from Advanced > Settings.) Each user role is mapped to one or more Zope ACL permissions, which allow you to restrict the portlets a permission level can see.

A user's specific portlet permissions are defined in part by Zope ACL permissions, and in part by the role to which he is assigned.

### 14.4.1. User Role to ACL Mapping

The following table shows how user roles map to ACLs.

User Roles	ACL Permission
ZenUser	ZenCommon, View
ZenManager, Manager	ZenCommon, View, Manage DMD
No Role, Administered Objs	ZenCommon

### 14.4.2. Setting Permissions

To set portlet permissions:

1. Select Advanced from the Navigation menu.

The Settings page appears.

2. In the left panel, select Portlets.

The Portlets page appears.

**Figure 14.1. Portlet Permissions**

Available Portlets	
Device Issues	Users with ZenCommon permission ▼
Google Maps	Users with View permission ▼
Zenoss Issues	Users with Manage DMD permission ▼
Production States	Users with ZenCommon permission ▼
Site Window	Users with View permission ▼
Top Level Organizers	Users with View permission ▼
Messages	Users with ZenCommon permission ▼
Watch List	Users with ZenCommon permission ▼

3. For one or more portlets in the Available Portlets list, select the permissions you want to apply.
4. Click **Save**.

### 14.4.3. Troubleshooting: Users Cannot See All Portlets

You may mistakenly block users from being able to access some portlets. Often, this happens when a user has been set to see only particular devices. By default, this user will see only portlets set to the ZenCommon permission level. In effect, this blocks three of six portlets.

To remedy this problem, you can:

- Change the permission levels (on the Portlets page) to ZenCommon, or
- Change the user role to a role higher than "No Role."

## 14.5. Backup and Recovery

In some situations, you might want to back up configuration information and data from a Zenoss Core instance, and then later restore that instance. You might do this periodically, to take regular "snapshots" of your instance to archive; or infrequently, such as to move data from one instance to another, or to restore a setup after performing a fresh installation. Zenoss Core provides tools that enable you to manage these backup and restore tasks.

### Note

To ensure successful backup and recovery, you must use the Zenoss Core `zenbackup` and `zenrestore` scripts. Manual backup of Zenoss Core data is not supported, and will not result in successful recovery.

With backup and restore, the system includes:

- Events database
- Zope database, which includes all devices, users, and event mappings
- `$ZENHOME/etc` directory, which contains configuration files for the system daemons
- `$ZENHOME/perf` directory, which contains performance data

Suggestions for a successful backup and restore experience:

- If you have the available disk space, tar and zip `$ZENHOME` before starting any backup or restore operation.
- Before running a backup or restore operation, run the `zenoss stop` command on the master and on all remote hubs and collectors.
- Avoid using these tools to go from a newer version of Zenoss Core to an older version.
- If you use these tools to go from an older version to a newer version, you should run `zenmigrate` after the restore operation.
- If restoring to a different Zenoss Core installation (one that differs from the backup version), make sure file paths in the `$ZENHOME/etc/*.conf` files are appropriate for the new environment after you restore.

The following sections describe backup and restore scripts, as well as options for controlling their behavior.

### 14.5.1. Backup (zenbackup)

The backup script is `$ZENHOME/bin/zenbackup`. Typical use of `zenbackup` looks like:

```
> zenbackup --file=BACKUPFILEPATH
```

If the system is running then you can run `zenbackup` without any arguments. A backup file will be placed in `$ZENHOME/backups`.

#### 14.5.1.1. Backup Options

The following table lists available `zenbackup` options.

## Note

Use the `zenbackup --help` command to see a complete list of `zenbackup` options.

Option	Description
<code>--cacheservers=CacheServers</code>	Specifies memcached servers to use for the object cache (for example, 127.0.0.1:11211).
<code>--compress-transport=CompressTransport</code>	Compress transport for MySQL backup and restore. The default value is True. Set to False to disable over-fast links that do not benefit from compression.
<code>-C ConfigFile, --configfile=ConfigFile</code>	Uses an alternate configuration file.
<code>--dont-fetch-args</code>	Instructs <code>zenbackup</code> not to attempt to get values for <code>zepdbhost</code> , <code>zepdbport</code> , <code>zepdbname</code> , <code>zepdbuser</code> , and <code>zepdbpass</code> from <code>\$ZENHOME/etc/zeneventserver.conf</code> . You must specify the options manually to access the events database.
<code>--genconf</code>	Generates a template configuration file.
<code>--genxmltable</code>	Generates a Docbook table showing command-line switches.
<code>--genxmlconfigs</code>	Generates an XML file containing command-line switches.
<code>--file=Filename</code>	Specifies a location for the backup file. By default, it is named <code>zenoss_Date.tgz</code> and placed in <code>\$ZENHOME/backups</code> .
<code>-h, --help</code>	Shows help contents.
<code>--host=Host</code>	Host name of the MySQL object store.
<code>--logseverity=LogSeverity</code>	Set the logging severity threshold.
<code>--mysqldb=MySQLDB</code>	Specifies the name of the database for the MySQL object store.
<code>--mysqluser=MySQLUser</code>	Specifies the user name for the MySQL object store.
<code>--mysqlpasswd=MySQLPasswd</code>	Specifies the password for the MySQL object store.
<code>--no-eventsdb</code>	Disables saving the events database as part of the backup.
<code>--no-perfdata</code>	Disables saving performance data in the backup.
<code>--no-save-mysql-access</code>	Instructs <code>zenbackup</code> not to save <code>host</code> , <code>port</code> , <code>mysqluser</code> , <code>mysqlpassword</code> , <code>mysqldb</code> , <code>zepdbhost</code> , <code>zepdbport</code> , <code>zepdbuser</code> , <code>zepdbpass</code> , and <code>zepdbname</code> as part of the backup file. Use this to prevent your backup files from containing a MySQL user name and password.
<code>no-zodb</code>	Disables saving the ZODB database and installed ZenPacks in the backup.
<code>--port=Port</code>	Specifies the port of the MySQL object store.
<code>--stdout</code>	Tells <code>zenbackup</code> to send the backup information to standard output instead of to a file. Incompatible with <code>--verbose</code> .
<code>--temp-dir=TempDir</code>	Specifies a directory to use for temporary storage.
<code>-v, --verbose</code>	Prints progress messages. Incompatible with <code>--stdout</code> .
<code>--version</code>	Shows the program's version number.
<code>--zepdbhost=ZEPDbHost</code>	Specifies the ZEP database server host. By default, this is fetched from Zenoss Core unless <code>--dont-fetch-args</code> is set.
<code>--zepdbname=ZEPDbName</code>	Specifies the ZEP database name. By default, this is fetched from Zenoss Core unless <code>--dont-fetch-args</code> is set.

Option	Description
<code>--zepdbpass=ZEPDbPass</code>	ZEP database password. y default, this is fetched from Zenoss Core unless <code>--dont-fetch-args</code> is set.
<code>--zepdbport=ZEPDbPort</code>	Specifies the ZEP database server port number. By default, this is fetched from Zenoss Core unless <code>--dont-fetch-args</code> is set.
<code>--zepdbuser=ZEPDbUser</code>	Specifies the ZEP database user name. By default, this is fetched from Zenoss Core unless <code>--dont-fetch-args</code> is set.

### 14.5.1.2. Create a Backup

To back up your system instance from the interface:

1. From the Navigation menu, select Advanced.

The Settings page appears.

2. In the left panel, select Backups.

The Backups page appears.

**Figure 14.2. Backup**

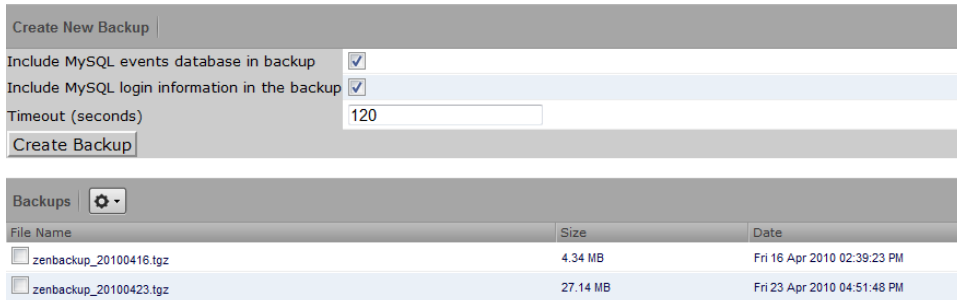

3. In the Create New Backup area, enter information or make selections for the backup. Options available are a subset of those available from the `zenbackup` command line tool.
4. Click **Create Backup**.

### 14.5.1.3. Delete a Backup

To delete a backup from the interface:

1. From the Navigation menu, select Advanced > Settings.
2. In the left panel, select Backups.

The Backups page appears. The Backups area lists all backup files in `$ZENHOME/backups`.

3. Select one or more files in the list, and then select Delete Backup from the Action menu.
4. Click **Delete** in the Delete Backup dialog to confirm the action.

### Note

Backup files can become large as your databases grow, so you may want to limit the number of backups you keep if drive space becomes an issue.

### 14.5.1.4. Remote Backups

Keeping backups on your server should help you recover if one of your databases becomes corrupt or your configuration becomes problematic. However, you should keep at least one recent backup file on a different server (ideally at a different physical location) in case a physical disk fails.

## 14.5.2. Restore (zenrestore)

The restore script is `$ZENHOME/bin/zenrestore`. Typical use of `zenrestore` looks like:

```
> zenrestore --file=BACKUPFILEPATH
```

### 14.5.2.1. Restore Options

The following table lists frequently used `zenrestore` options.

#### Note

Use the `zenrestore --help` command to see a complete list of `zenrestore` options.

Option	Description
<code>--file</code>	This is a backup file created with <code>zenbackup</code> . You must specify either <code>--file</code> or <code>--dir</code> .
<code>--dir</code>	The path to an unzipped backup file. You must specify either <code>--file</code> or <code>--dir</code> .
<code>--no-eventsdb</code>	Do not restore the events database. If the backup file does not contain MySQL events data then <code>zenrestore</code> will not modify your events database even if you do not specify <code>--no-eventsdb</code> .
<code>no-perfdata</code>	Disables saving performance data in the backup.
<code>no-zodb</code>	Disables saving the ZODB database and installed ZenPacks in the backup.
<code>-v, --verbose</code>	Print progress messages.

## 14.6. Working with the Job Manager

The Job Manager runs background tasks, such as discovering a network or adding a device. When you ask the system to perform one of these tasks, it adds a job to the queue. Jobs are run by the `zenjobs` daemon.

#### Note

Not all jobs run in the Job Manager. When running other jobs (in the foreground), do not navigate away from the current page until the job completes.

### 14.6.1. Viewing Jobs

To access the Job Manager:

1. From the Navigation menu, select Advanced.

The Settings page appears.

2. In the left panel, select Jobs.

The jobs list appears.

**Figure 14.3. Jobs List**

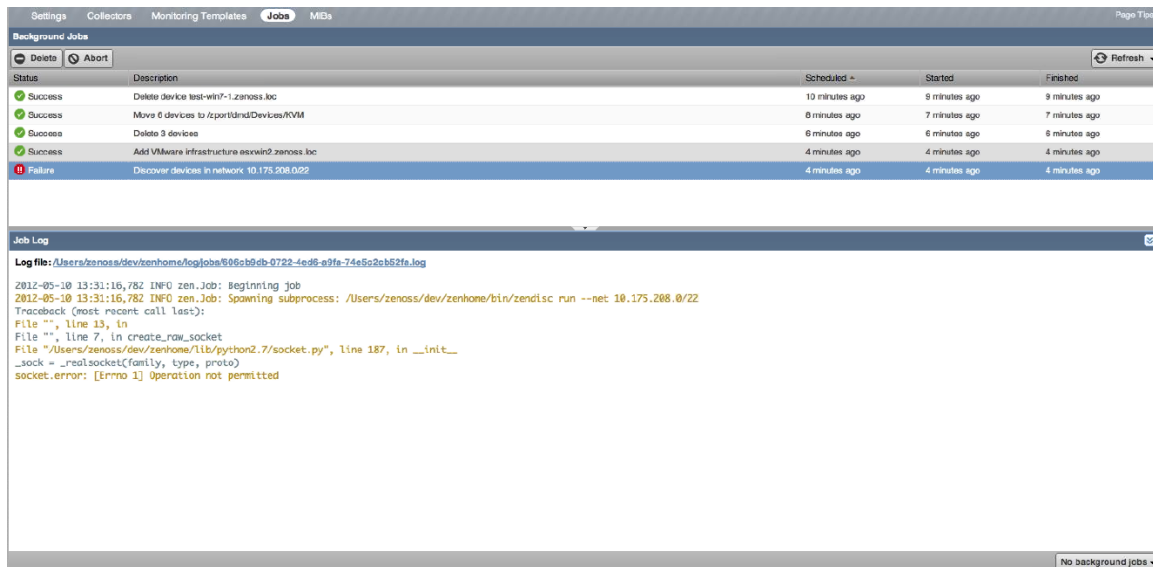

The jobs list shows information about all jobs currently in the system:

- **Status** - Shows the current job status. Status options are Pending (waiting for zenjobs to begin running), Running, Succeeded, and Failed.
- **Job Type** - Provides a short indicator of the job type.
- **Description** - Provides a longer description of the job. Generally, this includes the shell command run by the zenjobs daemon.
- **Started / Finished / Duration** - Provide information about the time period in which the job ran.
- **Actions** - Shows actions you can take on the job. These include:
  - **Job Log** - Click to view the real-time output of a running job or final output from a completed job.
  - **Stop** - Ask the zenjobs daemon to stop running this job.
  - **Delete** - Remove this job from the system.

### 14.6.2. Running the zenjobs Daemon

You can stop and start the zenjobs daemon from the command line and from Advanced > Settings (Daemons selection). You also can start it (if not already running) from the Job Manager. Click the link that appears at the top right of the jobs list.

**Figure 14.4. Start zenjobs**

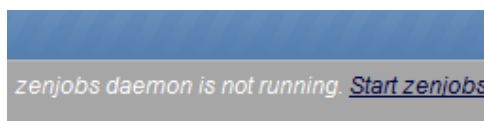



## 14.7. Host Name Changes

If you change the host name of your Zenoss Core server, then you must clear and rebuild queues before the `zenhub` and `zenjobs` daemons will restart.

To work around this issue, you can issue the following commands (although any data queued at restart time will be lost):

```
export VHOST="/zenoss"
export USER="zenoss"
export PASS="zenoss"
rabbitmqctl stop_app
rabbitmqctl reset
rabbitmqctl start_app
rabbitmqctl add_vhost "$VHOST"
rabbitmqctl add_user "$USER" "$PASS"
rabbitmqctl set_permissions -p "$VHOST" "$USER" '.*' '.*' '.*'
```

## 14.8. Versions and Update Checks

You can check to see if there are newer versions of Zenoss Core available. By default, the system is configured to check for this each day; however, you can verify this at any time from **Advanced > Settings > Versions**. Click **Check Zenoss Version Now** to check for updates.

When the system performs its daily update check (enabled by the Check for Updates Daily option), by default it sends non-identifying system metrics to Zenoss. Types of information sent about your Zenoss Core installation include:

- Device count
- Number of systems, locations, and groups
- Installed ZenPacks
- Event count
- System statistics (such as operating system and version)
- Number of users
- Performance data (such as memory and file system space used)

To view a sample report of this data, browse to:

<http://community.zenoss.org/docs/DOC-13114>

You can disable the collection and transmittal of this anonymous data by de-selecting the Send Anonymous Usage Info with Daily Update Check option.

---

# Appendix A. Daemon Commands and Options

Zenoss Core daemons provide the services that collect and feed data to the data layer. These daemons are divided among the following categories:

- Automated modeling
- Availability monitoring
- Event collection
- Performance monitoring
- Automated response

## A.1. Automated Modeling Daemons

### A.1.1. zendisc

Discovers new network resources. zendisc is a subclass of zenmodeler. It walks the routing table to discover the network topology, and then pings all discovered networks to find active IP addresses and devices.

### A.1.2. zenmodeler

Configuration collection and configuration daemon, used for high-performance, automated model population. It uses SNMP, SSH, Telnet, and WMI to collect its information. zenmodeler works against devices that have been loaded into the DMD. It models devices on a periodic schedule (typically every 12 hours).

## A.2. Availability Monitoring Daemons

### A.2.1. zenping

Performs high-performance, asynchronous testing of ICMP status. Uses the Standard model to perform Layer 3 -aware network topology monitoring.

### A.2.2. zenstatus

Performs active TCP connection testing of remote daemons.

### A.2.3. zenprocess

Checks for the existence of monitored processes by using SNMP host resources' MIB, logging their CPU and memory utilization. For cases in which more than one process is matched, sums the CPU and memory and tracks the process count.

## A.3. Event Collection Daemons

### A.3.1. zensyslog

Collects and classifies syslog events. Parses the raw format to find the level and facility, host name, and tag (the freeform message string of the event). Syslog events often have specific, proprietary formats used by vendors; zen-

syslog tries to parse these by using a series of regular expressions defined in it. Once parsing is complete, the event is sent back to the event system (through zenhub) to be integrated with the model.

### A.3.2. zeneventlog

Collects Windows Management Instrumentation (WMI) event log events. Forwards these events to zenhub for further processing.

### A.3.3. zentrap

Collects SNMP traps, parses them, resolves OIDs into MIB names, and then forwards them to zenhub for further rules processing.

## A.4. Performance Monitoring Daemons

### A.4.1. zenperfsnmp

Performs high-performance, asynchronous SNMP performance collection and stores it locally to the collector. Thresholds are tested each time a value is written to disk.

### A.4.2. zencommand

Performs XML RPC collection. Allows running of Nagios© and Cactii plug-ins on the local box, or on remote boxes through SSH. Commands must conform to the Nagios or Cactii API specifications.

## A.5. Automated Response Daemons

### A.5.1. zenactiond

Runs background jobs, such as email notification, database aging, and maintenance window processing.

The `zenactiond` daemon can detect connectivity issues to the ZODB or to the MySQL database. Since both of these services are critical to basic operations, if either of them is unavailable, then `zenactiond` can send an email or pager alert. Since ZODB may not be available when the connectivity issue occurs (for example, when the `zenactiond` daemon is starting), the daemon includes these command line options:

- `paniccommand [ email | page ]` - Sends email (default) or a page when this happens. If no other information is specified, then no action can be taken.
- `zeotimeout` - Specifies how many seconds to check to see if the database connection is still considered to be connected.
- `panicmaxalerts` - Specifies the maximum number of alerts that will be sent about an issue. Setting this to a value of 0 sends all alerts.

For email alerts:

- `panichost` - Email server
- `panictarget` - Destination email address
- `panicfromaddress` - The apparent sender of the email
- `panicport` - Port to send the email (by default, 25)

- `panicusetls` - Specifies to use Transport Layer Security (TLS) mechanisms
- `panicusername` - For authenticated email, the user name
- `panicpassword` - For authenticated email, the password

For pager alerts:

- `panictarget` - Space-separated list of pager addresses
- `panicpagecommand` - Command to use for sending the page

For maintenance windows:

`maintenance-window-cycletime` - Specifies how often `zenactiond` will check for whether to execute a maintenance window. By default, this is every 60 seconds.

---

# Appendix B. SNMP Device Preparation

This appendix provides information about SNMP support and lists Net-SNMP configuration settings that are required by the system.

## B.1. Net-SNMP

By default, Net-SNMP does not publish the full SNMP tree. Check to see if that is currently the case on a device and configure it correctly.

1. Confirm snmpd is running:

```
> snmpwalk -v1 -cpublic <your device name> system
```

2. Retrieve the IP table for the device with snmpwalk:

```
> snmpwalk -v1 -cpublic <your device name> ip
```

Typical SNMP View:

```
view systemview included .1
view systemview included .1.3.6.1.2.1.25.1
access notConfigGroup "" any noauth exact systemview none none
```

## B.2. SNMP V3 Support

Zenoss Core provides support for SNMPv3 data collection.

The following configuration properties control the authentication and privacy of these requests:

- **zSnmpAuthType** - Use "MD5" or "SHA" signatures to authenticate SNMP requests.

If only zSnmpAuthType and zSnmpAuthPassword are set, then the message is sent with authentication but no privacy.

- **zSnmpAuthPassword** - Shared private key used for authentication. Must be at least 8 characters long.
- **zSnmpPrivType** - "DES" or "AES" cryptographic algorithms.

If zSnmpPrivType and zSnmpPrivPassword are set, then the message is sent with privacy and authentication.

You cannot set a PrivType and PrivPassword without also setting an AuthType and AuthPassword. If neither Priv nor Auth values are set, then the message is sent with no authentication or privacy.

- **zSnmpPrivKey** - Shared private key used for encrypting SNMP requests. Must be at least 8 characters long.
- **zSnmpSecurityName** - Security Name (user) to use when making SNMPv3 requests.

If monitoring SNMPv3 devices, make sure that msgAuthoritativeEngineID (also known as snmpEngineID or Engine ID) is not shared by two devices. It must be unique for each device.

### B.2.1. Advanced Encryption Standard

SNMPv3 encryption using the Advanced Encryption Standard (AES) algorithm is supported only if the host platform net-snmp library supports it.

You can determine if your platform supports AES by using the following test:

```
$ snmpwalk -x AES 2>&1 | head -1
```

If the response is:

```
"Invalid privacy protocol specified after -x flag: AES"
```

then your platform does not support AES encryption for SNMPv3.

If the response is:

```
"No hostname specified."
```

Then your platform supports AES.

## B.3. Community Information

Add these lines to your `snmp.conf` file.

This line will map the community name "public" into a "security name":

```
# sec.name source community
com2sec notConfigUser default public
```

This line will map the security name into a group name:

```
# groupName securityModel securityName
group notConfigGroup v1 notConfigUser
group notConfigGroup v2c notConfigUser
```

This line will create a view for you to let the group have rights to:

```
# Make at least snmpwalk -v 1 localhost -c public system fast again.
# name incl/excl subtree mask(optional)
view systemview included .1
```

This line will grant the group read-only access to the systemview view.

```
# group context sec.model sec.level prefix read write
notif
access notConfigGroup "" any noauth exact systemview
none none
```

## B.4. System Contact Information

It is also possible to set the `sysContact` and `sysLocation` system variables through the `snmpd.conf` file:

```
syslocation Unknown (edit /etc/snmp/snmpd.conf)
syscontact Root <root@localhost> (configure /etc/snmp/snmp.local.conf)
# Added for support of bcm5820 cards. pass .1 /usr/bin/ucd5820stat
```

## B.5. Extra Information

For more information, see the `snmpd.conf` manual page, and the output of the `snmpd -H` command.

```
trapcommunity public
```

```
trapsink default
```

---

# Appendix C. Syslog Device Preparation

## C.1. Forwarding Syslog Messages from UNIX/Linux Devices

Zenoss Core has its own syslog server, zensyslog. Managed devices should point their syslog daemons to the system. To do this, edit the `/etc/syslog.conf` file and add an entry, where 1.2.3.4 is the zensyslog IP:

1. Log on to the target device (as a super user).
2. Open `/etc/syslog.conf` file with a text editor (such as vi).
3. Enter `*.debug` and press the Tab key. Then enter the host name or IP address of the server. For example:

```
*.debug @192.168.X.X
```

4. Save the file and exit the file editor program.
5. Restart the Syslog service using the command below:

```
/etc/init.d/syslog restart
```

## C.2. Forwarding Syslog Messages from a Cisco IOS Router

Here are some links to Cisco commands to turn on syslog. Typically, it is easier to use syslog than SNMP traps from network devices. The most basic IOS command to send syslog messages is:

```
logging 1.2.3.4
```

### C.2.1. Other Cisco Syslog Configurations

Here are some additional configurations for other Cisco devices. To set up these configurations follow the following steps using the configurations that follow below.

1. Log on to the target router.
2. Type the command `enable` at the prompt.
3. Once you are prompted for a password, enter the correct password.
4. Type the command `config` at the prompt.
5. Type the command `terminal` at the configuration prompt.
6. At the prompt, Set the Syslog forwarding mechanism. See example below:

```
logging <IP address of the server>
```

7. Exit out all the prompts to the main router prompt.

Catalyst

```
set logging server enable
```



```
set logging server 192.168.1.100
set logging level all 5
set logging server severity 6
```

#### Local Director

```
syslog output 20.5
no syslog console
syslog host 192.168.1.100
```

#### PIX Firewalls

```
logging on
logging standby
logging timestamp
logging trap notifications
logging facility 19
logging host inside 192.168.1.100
```

## C.3. Forwarding Syslog Messages from a Cisco CatOS Switch

1. Log on to the target switch.
2. Type the command enable at the prompt.
3. Once you are prompted for a password, enter the correct password.
4. Set the Syslog forwarding mechanism. See example below:

```
set logging server <IP address of the server>
```

5. You can set the types of logging information that you want the switch to provide with the commands below as examples:

```
set logging level mgmt 7 default
set logging level sys 7 default
set logging level filesys 7 default
```

## C.4. Forwarding Syslog Messages using Syslog-ng

Here is an example for FreeBSD and Linux platforms.

1. Log on to the target device (as a super user)
2. Open /etc/syslog-ng/syslog-ng.conf file with a text editor (e.g VI).
3. Add source information to file. See example below:

FreeBSD:

```
source src { unix-dgram("/var/run/log"); internal ();};
```

Linux: (will gather both system and kernel logs)

```
source src {
internal();
unix-stream("/dev/log" keep-alive(yes) max-connections(100));
pipe("/proc/kmsg");
udp();
```

```
};
```

4. Add destination information (in this case, the server). For example:

```
log { source(src); destination(zenoss); };
```

---

# Appendix D. TALES Expressions

## D.1. About Tales Expressions

Use TALES syntax to retrieve values and call methods on Zenoss Core objects. Several areas accept TALES syntax; these include:

- Command templates
- User commands
- Notifications
- zLinks

Commands (those associated with devices and those associated with events) can use TALES expressions to incorporate data from the related devices or events. TALES is a syntax for specifying expressions that let you access the attributes of certain objects, such as a device or an event.

For additional documentation on TALES syntax, see the TALES section of the Zope Page Templates Reference:

<http://docs.zope.org/zope2/zope2book/AppendixC.html>

Depending on context, you may have access to a device, an event, or both. Following is a list of the attributes and methods you may want to use on device and event objects. The syntax for accessing device attributes and methods is `${dev/attributename}`. For example, to get the `manageIp` of a device you would use `${dev/manageIp}`. For events, the syntax is `${evt/attributename}`.

A command to ping a device might look like this. (The `${..}` is a TALES expression to get the `manageIp` value for the device.)

```
ping -c 10 ${device/manageIp}
```

### D.1.1. Examples

- DNS Forward Lookup (assumes device/id is a resolvable name)

```
host ${device/id}
```

- DNS Reverse Lookup

```
host ${device/manageIp}
```

- SNMP Walk

```
snmpwalk -v1 -c${device/zSnmpCommunity} ${device/manageIp} system
```

To use these expressions effectively, you must know which objects, attributes, and methods are available, and in which contexts. Usually there is a device that allows you to access the device in a particular context. Contexts related to a particular event usually have event defined.

## D.2. TALES Device Attributes

The following table lists available device attributes.

Attribute	Description
getId	The primary means of identifying a device within the system
getManageIp	The IP address used to contact the device in most situations

Attribute	Description
productionState	The production status of the device: Production, Pre-Production, Test, Maintenance or Decommissioned. This attribute is a numeric value, use getProductionStateString for a textual representation.
getProductionStateString	Returns a textual representation of the productionState
snmpAgent	The agent returned from SNMP collection
snmpDescr	The description returned by the SNMP agent
snmpOid	The oid returned by the SNMP agent
snmpContact	The contact returned by the SNMP agent
snmpSysName	The system name returned by the SNMP agent
snmpLocation	The location returned by the SNMP agent
snmpLastCollection	When SNMP collection was last performed on the device. This is a DateTime object.
getSnmpLastCollectionString	Textual representation of snmpLastCollection
rackSlot	The slot name/number in the rack where this physical device is installed
comments	User entered comments regarding the device
priority	A numeric value: 0 (Trivial), 1 (Lowest), 2 (Low), 3 (Normal), 4 (High), 5 (Highest)
getPriorityString	A textual representation of the priority
getHWManufacturerName	Name of the manufacturer of this hardware
getHWProductName	Name of this physical product
getHWProductKey	Used to associate this device with a hardware product class
getOSManufacturerName	Name of the manufacturer of this device's operating system.
getOSProductName	Name of the operating system running on this device.
getOSProductKey	Used to associate the operating system with a software product class
getHWSerialNumber	Serial number for this physical device
getLocationName	Name of the Location assigned to this device
getLocationLink	Link to the system page for the assigned Location
getSystemNames	A list of names of the Systems this device is associated with
getDeviceGroupNames	A list of names of the Groups this device is associated with
getOsVersion	Version of the operating system running on this device
getLastChangeString	When the last change was made to this device
getLastPollSnmpUpTime	Uptime returned from SNMP
uptimeStr	Textual representation of the SNMP uptime for this device
getPingStatusString	Textual representation of the ping status of the device
getSnmpStatusString	Textual representation of the SNMP status of the device

### D.3. Tales Event Attributes

The following table lists available event attributes.

Attribute	Description
agent	Collector name from which the event came (such as zensyslog or zentrap).

Attribute	Description
component	Component of the associated device, if applicable. (Examples: eth0, httpd.)
count	Number of times this event has been seen.
dedupid	Key used to correlate duplicate events. By default, this is: device, component, event-Class, eventKey, severity.
device	ID of the associated device, if applicable.
DeviceClass	Device class from device context.
DeviceGroups	Device systems from device context, separated by  .
eventClass	Event class associated with this device. If not specified, may be added by the rule process. If this fails, then will be /Unknown.
eventClassKey	Key by which rules processing begins. Often equal to component.
eventGroup	Logical group of event source (such as syslog, ping, or nteventlog).
eventKey	Primary criteria for mapping events into event classes. Use if a component needs further de-duplication specification.
eventState	State of event. 0 = new, 1 = acknowledged, 2 = suppressed.
evid	Unique ID for the event.
facility	syslog facility, if this is a syslog event.
firstTime	UNIX timestamp when event is received.
ipAddress	IP Address of the associated device, if applicable.
lastTime	Last time this event was seen and its count incremented.
Location	Device location from device context.
manager	Fully qualified domain name of the collector from which this event came.
message	Full message text.
ntevvid	nt event ID, if this is an nt eventlog event.
priority	syslog priority, if this is a syslog event.
prodState	prodState of the device context.
severity	One of 0 (Clear), 1 (Debug), 2 (Info), 3 (Warning), 4 (Error) or 5 (Critical).
stateChange	Time the MySQLrecord for this event was last modified.
summary	Text description of the event. Limited to 150 characters.
suppid	ID of the event that suppressed this event.
Systems	Device systems from device context, separated by  .

## Configuration Properties and Custom Properties

Configuration properties and custom properties also are available for devices, and use the same syntax as shown in the previous sections.